

Lenovo™ **Think**Products

PSREF



Product Specifications Reference

Version 502, February 2017

U.S.

Visit <http://psref.lenovo.com> for the latest version

Lenovo **ThinkPad** Laptops

PSREF



Product Specifications Reference

Version 502, February 2017

U.S.

Visit <http://psref.lenovo.com> for the latest version

Contents

Cover		
Contents		
Summary Of Change		
11e Series		
ThinkPad 11e (3rd Gen)		
ThinkPad 11e (3rd Gen) Platform Specifications	1	ThinkPad E465 - TopSeller - 20EX 35
ThinkPad 11e (3rd Gen) - TopSeller - 20GB	2	ThinkPad E470 36
ThinkPad 11e (3rd Gen) Chromebook	5	ThinkPad E470 Platform Specifications 37
ThinkPad 11e (3rd Gen) Chromebook Platform Specifications	6	ThinkPad E470 - TopSeller - 20H1 38
ThinkPad 11e (3rd Gen) Chromebook - TopSeller - 20GF	6	ThinkPad E475 39
	7	ThinkPad E475 Platform Specifications 40
	8	ThinkPad E475 - TopSeller - 20H4 41
13 Series	9	ThinkPad E550 42
ThinkPad 13	10	ThinkPad E550 Platform Specifications 43
ThinkPad 13 Platform Specifications	11	ThinkPad E550 - TopSeller - 20DF - 1 of 4 44
ThinkPad 13 - TopSeller - 20GJ - 1 of 3	12	ThinkPad E550 - TopSeller - 20DF - 2 of 4 45
ThinkPad 13 - TopSeller - 20GJ - 2 of 3	12	ThinkPad E550 - TopSeller - 20DF - 3 of 4 46
ThinkPad 13 - TopSeller - 20GJ - 3 of 3	13	ThinkPad E550 - TopSeller - 20DF - 4 of 4 47
ThinkPad 13 - 20GJ	14	ThinkPad E560 48
ThinkPad 13 (2nd Gen)	15	ThinkPad E560 Platform Specifications 49
ThinkPad 13 (2nd Gen) Platform Specifications	16	ThinkPad E560 - TopSeller - 20EV - 1 of 2 50
ThinkPad 13 (2nd Gen) - TopSeller - 20J1	17	ThinkPad E560 - TopSeller - 20EV - 2 of 2 51
ThinkPad 13 Chromebook	18	ThinkPad E565 52
ThinkPad 13 Chromebook Platform Specifications	19	ThinkPad E565 Platform Specifications 53
ThinkPad 13 Chromebook - TopSeller - 20GL	20	ThinkPad E565 - TopSeller - 20EY - 1 of 2 54
	21	ThinkPad E565 - TopSeller - 20EY - 2 of 2 55
E Series	22	ThinkPad E570 56
ThinkPad E450	23	ThinkPad E570 Platform Specifications 57
ThinkPad E450 Platform Specifications	24	ThinkPad E570 - TopSeller - 20H5 58
ThinkPad E450 - TopSeller - 20DC - 1 of 4	24	ThinkPad E575 59
ThinkPad E450 - TopSeller - 20DC - 2 of 4	25	ThinkPad E575 Platform Specifications 60
ThinkPad E450 - TopSeller - 20DC - 3 of 4	26	ThinkPad E575 - TopSeller - 20H8 61
ThinkPad E450 - TopSeller - 20DC - 4 of 4	27	L Series 62
ThinkPad E460	28	ThinkPad L450 62
ThinkPad E460 Platform Specifications	29	ThinkPad L450 Platform Specifications 63
ThinkPad E460 - TopSeller - 20ET	30	ThinkPad L450 - TopSeller - 20DT 64
	31	ThinkPad L450 - 20DS - 1 of 3 65
ThinkPad E465	32	ThinkPad L450 - 20DS - 2 of 3 66
ThinkPad E465 Platform Specifications	33	ThinkPad L450 - 20DS - 3 of 3 67
	34	ThinkPad L460 68

Contents

ThinkPad L460 Platform Specifications	69
ThinkPad L460 - TopSeller - 20FU - 1 of 2	70
ThinkPad L460 - TopSeller - 20FU - 2 of 2	71
ThinkPad L470	72
ThinkPad L470 Platform Specifications	73
ThinkPad L470 - TopSeller - 20J4	74
ThinkPad L560	75
ThinkPad L560 Platform Specifications	76
ThinkPad L560 - TopSeller - 20F1 - 1 of 2	77
ThinkPad L560 - TopSeller - 20F1 - 2 of 2	78
P Series	79
ThinkPad P50	79
ThinkPad P50 Platform Specifications	80
ThinkPad P50 - TopSeller - 20EN - 1 of 2	81
ThinkPad P50 - TopSeller - 20EN - 2 of 2	82
ThinkPad P50 - TopSeller - 20EQ	83
ThinkPad P50s	84
ThinkPad P50s Platform Specifications	85
ThinkPad P50s - TopSeller - 20FL	86
ThinkPad P70	87
ThinkPad P70 Platform Specifications	88
ThinkPad P70 - TopSeller - 20ER - 1 of 2	89
ThinkPad P70 - TopSeller - 20ER - 2 of 2	90
T Series	91
ThinkPad T450	91
ThinkPad T450 Platform Specifications	92
ThinkPad T450 - TopSeller - 20BV - 1 of 2	93
ThinkPad T450 - TopSeller - 20BV - 2 of 2	94
ThinkPad T450 - 20BU - 1 of 2	95
ThinkPad T450 - 20BU - 2 of 2	96
ThinkPad T460	97
ThinkPad T460 Platform Specifications	98
ThinkPad T460 - TopSeller - 20FN - 1 of 2	99
ThinkPad T460 - TopSeller - 20FN - 2 of 2	100
ThinkPad T460p	101

ThinkPad T460p Platform Specifications	102
ThinkPad T460p - TopSeller - 20FW	103
ThinkPad T460s	104
ThinkPad T460s Platform Specifications	105
ThinkPad T460s - TopSeller - 20F9 - 1 of 3	106
ThinkPad T460s - TopSeller - 20F9 - 2 of 3	107
ThinkPad T460s - TopSeller - 20F9 - 3 of 3	108
ThinkPad T470	109
ThinkPad T470 Platform Specifications	110
ThinkPad T470 - TopSeller - 20HD	111
ThinkPad T470s	112
ThinkPad T470s Platform Specifications	113
ThinkPad T470s - TopSeller - 20HF	114
ThinkPad T560	115
ThinkPad T560 Platform Specifications	116
ThinkPad T560 - TopSeller - 20FH - 1 of 2	117
ThinkPad T560 - TopSeller - 20FH - 2 of 2	118
ThinkPad T570	119
ThinkPad T570 Platform Specifications	120
ThinkPad T570 - TopSeller - 20H9	121
X Series	122
ThinkPad X1 Carbon (4th Gen)	122
ThinkPad X1 Carbon (4th Gen) Platform Specifications	123
ThinkPad X1 Carbon (4th Gen) - TopSeller - 20FB - 1 of 5	124
ThinkPad X1 Carbon (4th Gen) - TopSeller - 20FB - 2 of 5	125
ThinkPad X1 Carbon (4th Gen) - TopSeller - 20FB - 3 of 5	126
ThinkPad X1 Carbon (4th Gen) - TopSeller - 20FB - 4 of 5	127
ThinkPad X1 Carbon (4th Gen) - TopSeller - 20FB - 5 of 5	128
ThinkPad X1 Carbon (5th Gen)	129
ThinkPad X1 Carbon (5th Gen) Platform Specifications	130
ThinkPad X1 Carbon (5th Gen) - TopSeller - 20HR	131
ThinkPad X250	132
ThinkPad X250 Platform Specifications	133
ThinkPad X250 - TopSeller - 20CM - 1 of 3	134
ThinkPad X250 - TopSeller - 20CM - 2 of 3	135

Contents

ThinkPad X250 - TopSeller - 20CM - 3 of 3	136
ThinkPad X250 - 20CL - 1 of 3	137
ThinkPad X250 - 20CL - 2 of 3	138
ThinkPad X250 - 20CL - 3 of 3	139
ThinkPad X260	140
ThinkPad X260 Platform Specifications	141
ThinkPad X260 - TopSeller - 20F6 - 1 of 4	142
ThinkPad X260 - TopSeller - 20F6 - 2 of 4	143
ThinkPad X260 - TopSeller - 20F6 - 3 of 4	144
ThinkPad X260 - TopSeller - 20F6 - 4 of 4	145
ThinkPad X270	146
ThinkPad X270 Platform Specifications	147
ThinkPad X270 - TopSeller - 20HN	148
Legal Information	149

Summary of Changes

This section describes the technical changes made in this edition.

This edition might also include minor corrections and editorial changes which are not identified.

February 15, 2017 - Version 502

Additions in this update

► **New product(s)**

ThinkPad L470 models announced January 2017

ThinkPad T470 models announced January 2017

ThinkPad T470s models announced February 2017

ThinkPad T570 models announced January 2017

ThinkPad X270 models announced February 2017

ThinkPad X1 Carbon (5th Gen) models announced February 2017

► **New model(s)**

ThinkPad 13 (2nd Gen) models announced January 2017

► **Others**

None

Withdrawals in this update

► **Withdrawn product(s)**

None



ThinkPad 11e (3rd Gen) Platform Specifications

Product Specifications Reference (PSREF)

Processor	Intel® Celeron® processor, Intel Pentium® Processor, or 6th Generation Intel Core™ i3 Processor							Media reader	4-in-1 reader (MMC, SD, SDHC, SDXC)																																	
								Ports	Two USB 3.0, HDMI, Ethernet (RJ-45)																																	
								Control buttons	Power button, volume control button																																	
								Camera	HD720p resolution, low light sensitive, fixed focus																																	
								Audio support	HD Audio, Realtek® ALC3245 codec / stereo speakers, 2W x 2 / monaural digital microphone, combo audio/microphone jack																																	
<table border="1"> <thead> <tr> <th>Processor Number</th> <th># of Cores</th> <th># of Threads</th> <th>Base Frequency</th> <th>Burst Frequency</th> <th>Cache</th> <th>Memory Types</th> <th>Processor Graphics</th> </tr> </thead> <tbody> <tr> <td>Cel N3150</td> <td rowspan="2">4</td> <td rowspan="2">4</td> <td>1.6 GHz</td> <td>2.08 GHz</td> <td>2MB</td> <td rowspan="4">DDR3L-1600</td> <td>Intel HD graphics</td> </tr> <tr> <td>Cel N3160</td> <td>1.6 GHz</td> <td>2.24 GHz</td> <td>2MB</td> <td>Intel HD graphics 400</td> </tr> <tr> <td>Pen 4405U</td> <td rowspan="2">2</td> <td rowspan="2">4</td> <td>2.1 GHz</td> <td>-</td> <td>2MB</td> <td>Intel HD graphics 510</td> </tr> <tr> <td>i3-6100U</td> <td>2.3 GHz</td> <td>-</td> <td>3MB</td> <td>Intel HD graphics 520</td> </tr> </tbody> </table>							Processor Number	# of Cores	# of Threads	Base Frequency	Burst Frequency	Cache	Memory Types	Processor Graphics	Cel N3150	4	4	1.6 GHz	2.08 GHz	2MB	DDR3L-1600	Intel HD graphics	Cel N3160	1.6 GHz	2.24 GHz	2MB	Intel HD graphics 400	Pen 4405U	2	4	2.1 GHz	-	2MB	Intel HD graphics 510	i3-6100U	2.3 GHz	-	3MB	Intel HD graphics 520	Keyboard	ThinkPad Windows keyboard, 6-row, multimedia Fn keys	
Processor Number	# of Cores	# of Threads	Base Frequency	Burst Frequency	Cache	Memory Types	Processor Graphics																																			
Cel N3150	4	4	1.6 GHz	2.08 GHz	2MB	DDR3L-1600	Intel HD graphics																																			
Cel N3160			1.6 GHz	2.24 GHz	2MB		Intel HD graphics 400																																			
Pen 4405U	2	4	2.1 GHz	-	2MB		Intel HD graphics 510																																			
i3-6100U			2.3 GHz	-	3MB		Intel HD graphics 520																																			
							Touchpad	Buttonless touchpad below keyboard, multi-touch																																		
Graphics	Intel HD Graphics, Intel HD Graphics 510, or Intel HD Graphics 520 in processor, supports external digital monitor via HDMI™; supports dual independent display; Max resolution: 1920X1080 (HDMI)@30Hz							Security	Power-on password, hard disk password, supervisor password, security keyhole																																	
Chipset	Intel SoC (System on Chip) platform							Security chip	<i>Win7 model:</i> discrete TPM 1.2, TCG Certified																																	
Memory	2GB, 4GB, or 8GB / PC3-12800 1600MHz DDR3L, one DDR3L SO-DIMM socket								<i>Win10 model:</i> discrete TPM 1.2 TCG Certified and Firmware TPM 2.0 in chipset																																	
Display	11.6" (295mm) HD (1366x768), anti-glare, LED backlight, 220 nits, 16:9 aspect ratio, 500:1 contrast ratio							vPro	None																																	
Multi-touch	None							Fingerprint reader	None																																	
Hinge	Normal hinge, 180 degree							Battery	Integrated Lithium Polymer 3-cell (42Wh)																																	
Storage	M.2 Solid State Drive (SSD), SATA 6.0Gb/s							Max battery life ¹⁰	<i>MobileMark® 2014:</i> 11.53 hr																																	
Optical	None							AC adapter	45-watt AC adapter																																	
Ethernet	Realtek RTL8111GUS-CG Gigabit Network Connection							Preload	Windows 7 Professional 64 preinstalled through downgrade rights in Windows 10 Pro 64																																	
WLAN ⁴	<i>One of the following, configurable by model:</i> • 11ac+BT, Intel Dual Band Wireless-AC 3165, 1x1, M.2 card • 11ac+BT, Intel Dual Band Wireless-AC 7265, 2x2, M.2 card								<i>Some:</i> Windows 10 Home 64 <i>Some:</i> Windows 10 Pro 64 <ul style="list-style-type: none"> • Lenovo Solution Center • Lenovo Companion • Lenovo Setting • Microsoft Office preloaded; purchase a product key to activate • McAfee® LiveSafe™ (30-day trial) 																																	
Bluetooth™	Bluetooth 4.0 wireless, integrated in Wi-Fi + Bluetooth combo adapter								<ul style="list-style-type: none"> • ThinkVantage Product Recovery • Rescue and Recovery™ • ThinkVantage System Update • Adobe® Reader® • Microsoft® Office preloaded; purchase a product key to activate • McAfee® LiveSafe™ (30-day trial) 																																	
WWAN	None							Limited warranty ¹²	<i>One of the following, configurable by model:</i> • 1-year depot repair service • 3-year/1-yr battery depot repair service (US only)																																	
Dimensions ³	<i>WxDxH:</i> 11.81" x 8.27" x 0.88"; 300mm x 210mm x 22.3mm							Mil-Spec test	MIL-STD-810G military certification																																	
Weight ²	from 3.3 lb (1.5kg)							Environment	EPEAT™ Gold (US only); ENERGY STAR® 6.1; RoHS-compliant																																	
Case color	<i>Display cover:</i> Graphite Black or Silver; <i>Bottom:</i> Graphite Black																																									
Case material	<i>Display cover:</i> PC+40%GF+TPU; <i>Bottom:</i> PCC																																									

Model	Region	Processor	Graphics	Memory	Display	Multi-touch	Storage	Optical	WLAN + Bluetooth	Color	Camera	Keyboard	Fingerprint Reader	TPM	Battery (internal)	Power Adapter	Operating System	Warranty	Ann Date (m/y)
20GB000JUS	US	Celeron N3150	Intel HD	4GBx1	11.6" HD (1366x768)	None	192GB SSD M.2	None	Intel 7265 ac, 2x2 + BT4.0	Black	720p	Non-backlit	None	dTPM1.2 + FW TPM2.0	3-cell (42Wh)	45W	Windows 10 Pro 64	1-year, Depot	02/16
20GB000KUS	US	Celeron N3150	Intel HD	8GBx1	11.6" HD (1366x768)	None	192GB SSD M.2	None	Intel 7265 ac, 2x2 + BT4.0	Black	720p	Non-backlit	None	dTPM1.2 + FW TPM2.0	3-cell (42Wh)	45W	Windows 10 Pro 64	1-year, Depot	02/16
20GB000LUS	US	Celeron N3150	Intel HD	8GBx1	11.6" HD (1366x768)	None	128GB SSD M.2	None	Intel 7265 ac, 2x2 + BT4.0	Black	720p	Non-backlit	None	dTPM1.2 + FW TPM2.0	3-cell (42Wh)	45W	Windows 10 Pro 64	1-year, Depot	02/16
20GB000MUS	US	Celeron N3150	Intel HD	8GBx1	11.6" HD (1366x768)	None	256GB SSD M.2 Opal2	None	Intel 7265 ac, 2x2 + BT4.0	Black	720p	Non-backlit	None	dTPM1.2 + FW TPM2.0	3-cell (42Wh)	45W	Windows 10 Pro 64	1-year, Depot	02/16
20GB000NUS	US	Celeron N3150	Intel HD	4GBx1	11.6" HD (1366x768)	None	128GB SSD M.2	None	Intel 7265 ac, 2x2 + BT4.0	Black	720p	Non-backlit	None	dTPM1.2 + FW TPM2.0	3-cell (42Wh)	45W	Windows 10 Pro 64	1-year, Depot	02/16
20GB000PUS	US	i3-6100U	Intel HD 520	4GBx1	11.6" HD (1366x768)	None	128GB SSD M.2	None	Intel 7265 ac, 2x2 + BT4.0	Black	720p	Non-backlit	None	dTPM1.2 + FW TPM2.0	3-cell (42Wh)	45W	Windows 10 Pro 64	1-year, Depot	02/16
20GB000QUS	US	i3-6100U	Intel HD 520	8GBx1	11.6" HD (1366x768)	None	128GB SSD M.2	None	Intel 7265 ac, 2x2 + BT4.0	Black	720p	Non-backlit	None	dTPM1.2 + FW TPM2.0	3-cell (42Wh)	45W	Windows 10 Pro 64	1-year, Depot	02/16
20GB000RUS	US	i3-6100U	Intel HD 520	8GBx1	11.6" HD (1366x768)	None	192GB SSD M.2	None	Intel 7265 ac, 2x2 + BT4.0	Black	720p	Non-backlit	None	dTPM1.2 + FW TPM2.0	3-cell (42Wh)	45W	Windows 10 Pro 64	1-year, Depot	02/16
20GB000SUS	US	i3-6100U	Intel HD 520	8GBx1	11.6" HD (1366x768)	None	256GB SSD M.2 Opal2	None	Intel 7265 ac, 2x2 + BT4.0	Black	720p	Non-backlit	None	dTPM1.2 + FW TPM2.0	3-cell (42Wh)	45W	Windows 10 Pro 64	1-year, Depot	02/16
20GB000UUS	US	i3-6100U	Intel HD 520	4GBx1	11.6" HD (1366x768)	None	192GB SSD M.2	None	Intel 7265 ac, 2x2 + BT4.0	Black	720p	Non-backlit	None	dTPM1.2 + FW TPM2.0	3-cell (42Wh)	45W	Windows 10 Pro 64	1-year, Depot	02/16
20GB001HUS	US	Celeron N3160	Intel HD 400	4GBx1	11.6" HD (1366x768)	None	128GB SSD M.2	None	Intel 7265 ac, 2x2 + BT4.0	Black	720p	Non-backlit	None	dTPM1.2 + FW TPM2.0	3-cell (42Wh)	45W	Windows 10 Pro 64	1-year, Depot	09/16
20GB001JUS	US	Celeron N3160	Intel HD 400	4GBx1	11.6" HD (1366x768)	None	256GB SSD M.2 Opal2	None	Intel 7265 ac, 2x2 + BT4.0	Black	720p	Non-backlit	None	dTPM1.2 + FW TPM2.0	3-cell (42Wh)	45W	Windows 10 Pro 64	1-year, Depot	09/16
20GB001KUS	US	Celeron N3160	Intel HD 400	8GBx1	11.6" HD (1366x768)	None	128GB SSD M.2	None	Intel 7265 ac, 2x2 + BT4.0	Black	720p	Non-backlit	None	dTPM1.2 + FW TPM2.0	3-cell (42Wh)	45W	Windows 10 Pro 64	1-year, Depot	09/16
20GB001LUS	US	Celeron N3160	Intel HD 400	8GBx1	11.6" HD (1366x768)	None	256GB SSD M.2 Opal2	None	Intel 7265 ac, 2x2 + BT4.0	Black	720p	Non-backlit	None	dTPM1.2 + FW TPM2.0	3-cell (42Wh)	45W	Windows 10 Pro 64	1-year, Depot	09/16



ThinkPad 11e (3rd Gen) Chromebook Platform Specifications

Product Specifications Reference (PSREF)

Processor	Intel® Celeron® processor								Dimensions ³	<i>WxDxH:</i> 11.81" x 8.27" x 0.88"; 300mm x 210mm x 22.3mm
	Processor Number	# of Cores	# of Threads	Base Frequency	Burst Frequency	Cache	Memory Types	Processor Graphics	Weight ²	from 3.3 lb (1.5kg)
	Cel N3150	4	4	1.6 GHz	2.08 GHz	2MB	DDR3L-1600	Intel HD graphics	Case color	<i>Display cover:</i> Graphite Black or Silver; <i>Bottom:</i> Graphite Black
Cel N3160			1.6 GHz	2.24 GHz	2MB	Intel HD graphics 400		Case material	<i>Display cover:</i> PC+40%GF+TPU; <i>Bottom:</i> PCC	
Graphics	Intel HD Graphics or Intel HD Graphics 400 in processor, supports external digital monitor via HDMI™; supports dual independent display; Max resolution: 1920X1080 (HDMI)@30Hz								Media reader	4-in-1 reader (MMC, SD, SDHC, SDXC)
Chipset	Intel SoC (System on Chip) platform								Ports	Two USB 3.0 (one Always On), HDMI
Memory	2GB or 4GB / 1600MHz LPDDR3 / soldered to systemboard, no sockets								Control buttons	None
Display	11.6" (295mm) HD (1366x768), anti-glare, LED backlight, 220 nits, 16:9 aspect ratio, 500:1 contrast ratio								Camera	HD720p resolution, low light sensitive, fixed focus
Multi-touch	None								Audio support	Realtek® ALC5650 codec / stereo speakers, 2W x 2 / monaural digital microphone, combo audio/microphone jack
Hinge	Normal hinge, 180 degree								Keyboard	ThinkPad Chrome keyboard, 6-row, multimedia Fn keys
Storage	16GB eMMC (embedded Multi Media Card) flash memory on board								Touchpad	Buttonless touchpad below keyboard, multi-touch
Optical	None								Security	Security keyhole
Ethernet	None								Security chip	Discrete TPM 1.2, TCG Certified
WLAN ⁴	11ac+BT, Intel Dual Band Wireless-AC 7265, 2x2, M.2 card								vPro	None
Bluetooth™	Bluetooth 4.0 wireless, integrated in Wi-Fi + Bluetooth combo adapter								Fingerprint reader	None
WWAN	None								Battery	Integrated Lithium Polymer 3-cell (42Wh)
									Max battery life ¹⁰	Up to 12 hr
									AC adapter	45-watt AC adapter
									Preload	Google Chrome OS
									Limited warranty ¹²	1-year depot repair service
									Mil-Spec test	MIL-STD-810G military certification
									Environment	EPPEAT™ Gold (US only); ENERGY STAR® 6.1; RoHS-compliant

ThinkPad 11e (3rd Gen) Chromebook - TopSeller - 20GF

Product Specifications Reference (PSREF)

Model	Region	Processor	Graphics	Memory (Soldered)	Display	Multi-touch	Storage	Optical	WLAN + Bluetooth	Color	Camera	Keyboard	Fingerprint Reader	TPM	Battery (internal)	Power Adapter	Operating System	Warranty	Ann Date (m/y)
20GF0001US	US	Celeron N3150	Intel HD	4GB Soldered	11.6" HD (1366x768)	None	16GB eMMC	None	Intel 7265 ac, 2x2 + BT4.0	Black	720p	Non-backlit	None	dTPM 1.2	3-cell (42Wh)	45W	Chrome OS	1-year, Depot	03/16
20GF0003US	US	Celeron N3160	Intel HD 400	4GB Soldered	11.6" HD (1366x768)	None	16GB eMMC	None	Intel 7265 ac, 2x2 + BT4.0	Black	720p	Non-backlit	None	dTPM 1.2	3-cell (42Wh)	45W	Chrome OS	1-year, Depot	10/16

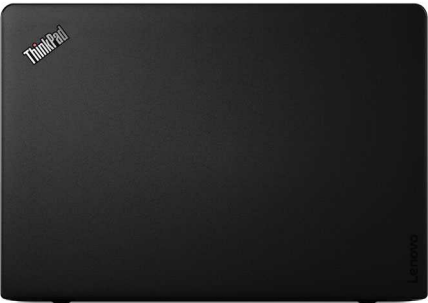

ThinkPad 13 Platform Specifications

Product Specifications Reference (PSREF)

Processor	Intel® Celeron® processor or 6th Generation Intel Core™ i3 / i5 Processor								Smart card reader	None	
	Processor Number	# of Cores	# of Threads	Base Frequency	Max Turbo Frequency	Cache	Memory Types	Processor Graphics	Media reader	4-in-1 reader (MMC, SD, SDHC, SDXC)	
	Cel 3855U	2	4	1.6 GHz	-	2MB	DDR4-2133	Intel HD graphics 510	Ports	Three USB 3.0 (one Always On), one USB Type-C, HDMI, Lenovo OneLink+ connector	
	i3-6100U			2.3 GHz	-	3MB		Intel HD graphics 520			
	i5-6200U			2.3 GHz	2.8 GHz	3MB					
	i5-6300U			2.4 GHz	3.0 GHz	3MB					
	i7-6500U			2.5 GHz	3.1 GHz	4MB			Camera	HD720p resolution, low light sensitive, fixed focus	
									Audio support	HD Audio, Realtek® ALC3245 codec / stereo speakers, 2W x 2 / dual array microphone, combo audio/microphone jack	
									Keyboard	ThinkPad Windows keyboard, 6-row, multimedia Fn keys	
									UltraNav™	TrackPoint® pointing device and buttonless Mylar surface touchpad, multi-touch	
Graphics	Intel HD Graphics 510 or 520 in processor, supports external digital monitor via HDMI or USB Type-C; supports three independent displays; Max resolution: 1920x1080 (HDMI)@60Hz, 3840X2160 (USB Type-C)@60Hz								Security	Power-on password, hard disk password, supervisor password, security keyhole	
Chipset	Intel SoC (System on Chip) platform								Security chip	Win7 model: discrete TPM 1.2, TCG Certified	
Memory	16GB max / 2133MHz DDR4, two DDR4 SO-DIMM sockets								Win10 model: discrete TPM 1.2 TCG Certified and Firmware TPM 2.0 in chipset	vPro (optional)	Intel vPro Technology
Display	Some: 13.3" (338mm) HD (1366x768), anti-glare, LED backlight, 200 nits, 16:9 aspect ratio, 500:1 contrast ratio								Fingerprint reader	Optional: Swipe style fingerprint reader on the keyboard bezel	
	Some: 13.3" (338mm) FHD (1920x1080), anti-glare, LED backlight, IPS, 220 nits, 16:9 aspect ratio, 600:1 contrast ratio, 170° viewing angle								Battery	Integrated Lithium Polymer 3-cell (42Wh)	
Multi-touch	None								Max battery life ¹⁰	MobileMark® 2014: 11.6 hr	
Storage	M.2 SSD / SATA 6.0Gb/s								AC adapter	45-watt AC adapter	
Optical	None								Preload	Some: Genuine Windows® 7 Professional 64	
Ethernet	Non-vPro model: Intel Ethernet Connection I219-V (Jacksonville)									Some: Windows 10 Home 64	
	vPro model: Intel Ethernet Connection I219-LM (Jacksonville)									Some: Windows 10 Pro 64	
WLAN ⁴	One of the following, configurable by model:									• Lenovo Solution Center	
	• 11ac+BT4.0, Intel Dual Band Wireless-AC 3165, 1x1, M.2 card									• Lenovo SHAREit	
	• 11ac+BT4.1, Intel Dual Band Wireless-AC 8260, 2x2, M.2 card									• Lenovo Companion	
Bluetooth™	Bluetooth 4.0 or 4.1 wireless, integrated in Wi-Fi + Bluetooth combo adapter									• Lenovo Setting	
WWAN	None									• Microsoft Office preloaded; purchase a product key to activate	
										• McAfee® LiveSafe™ (30-day trial)	
Dimensions ³	WxDxH (silver): 12.69" x 8.77" x 0.75"; 322.4mm x 222.8mm x 19.1mm								Limited warranty ¹²	One of the following, configurable by model:	
	WxDxH (black): 12.69" x 8.77" x 0.78"; 322.4mm x 222.8mm x 19.8mm									• 1-year depot repair service	
Weight ²	from 3.17 lb / 1.44 kg									• 3-year/1-yr battery depot repair service	
Case color	Pure Black or Silver									• 3-year/1-yr battery limited onsite service ²⁴	
Case material	Black cover: PC/ABS plastic;								Mil-Spec test	MIL-STD-810G military certification	
	Silver cover: Aluminum								Environment	EPEAT™ Gold (US only); ENERGY STAR® 6.1; RoHS-compliant	

Model	Region	Processor	vPro	Graphics	Memory	Display	Multi-touch	Storage	Optical	WLAN + Bluetooth	Color	Camera	Keyboard	Fingerprint Reader	TPM	Battery (internal)	Power Adapter	Operating System	Warranty	Ann Date (m/y)
20GJ0006US	US	Celeron 3855U	No	Intel HD 510	4GBx1	13.3" HD (1366x768)	None	128GB SSD M.2	None	Intel 8260 ac, 2x2 + BT4.1	Black	720p	Non-backlit	Fingerprint Reader	dTPM1.2 + FW TPM2.0	3-cell (42Wh)	45W	Windows 10 Pro 64	1-year, Depot	03/16
20GJ0007US	US	Celeron 3855U	No	Intel HD 510	4GBx1	13.3" FHD (1920x1080) IPS	None	128GB SSD M.2	None	Intel 8260 ac, 2x2 + BT4.1	Black	720p	Non-backlit	Fingerprint Reader	dTPM1.2 + FW TPM2.0	3-cell (42Wh)	45W	Windows 10 Pro 64	1-year, Depot	03/16
20GJ0008US	US	i5-6200U	No	Intel HD 520	8GBx2	13.3" FHD (1920x1080) IPS	None	512GB SSD M.2	None	Intel 8260 ac, 2x2 + BT4.1	Black	720p	Non-backlit	Fingerprint Reader	dTPM1.2 + FW TPM2.0	3-cell (42Wh)	45W	Windows 10 Pro 64	3-year, Depot	03/16
20GJ0009US	US	Celeron 3855U	No	Intel HD 510	4GBx2	13.3" HD (1366x768)	None	128GB SSD M.2	None	Intel 8260 ac, 2x2 + BT4.1	Black	720p	Non-backlit	Fingerprint Reader	dTPM1.2 + FW TPM2.0	3-cell (42Wh)	45W	Windows 10 Pro 64	3-year, Depot	03/16
20GJ000AUS	US	i3-6100U	No	Intel HD 520	4GBx1	13.3" FHD (1920x1080) IPS	None	128GB SSD M.2	None	Intel 8260 ac, 2x2 + BT4.1	Silver	720p	Non-backlit	None	dTPM 1.2	3-cell (42Wh)	45W	Windows 10 DG Windows 7 Pro 64	3-year, Depot	03/16
20GJ000DUS	US	i3-6100U	No	Intel HD 520	4GBx1	13.3" HD (1366x768)	None	128GB SSD M.2	None	Intel 8260 ac, 2x2 + BT4.1	Black	720p	Non-backlit	Fingerprint Reader	dTPM1.2 + FW TPM2.0	3-cell (42Wh)	45W	Windows 10 Pro 64	3-year, Depot	03/16
20GJ000EUS	US	i3-6100U	No	Intel HD 520	4GBx1	13.3" FHD (1920x1080) IPS	None	192GB SSD M.2	None	Intel 8260 ac, 2x2 + BT4.1	Black	720p	Non-backlit	Fingerprint Reader	dTPM1.2 + FW TPM2.0	3-cell (42Wh)	45W	Windows 10 Pro 64	3-year, Depot	03/16
20GJ000FUS	US	i3-6100U	No	Intel HD 520	4GBx2	13.3" HD (1366x768)	None	128GB SSD M.2	None	Intel 8260 ac, 2x2 + BT4.1	Silver	720p	Non-backlit	None	dTPM 1.2	3-cell (42Wh)	45W	Windows 10 DG Windows 7 Pro 64	3-year, Depot	03/16
20GJ000GUS	US	i3-6100U	No	Intel HD 520	4GBx2	13.3" HD (1366x768)	None	128GB SSD M.2	None	Intel 8260 ac, 2x2 + BT4.1	Silver	720p	Non-backlit	None	dTPM 1.2	3-cell (42Wh)	45W	Windows 10 DG Windows 7 Pro 64	3-year, Depot	03/16
20GJ000HUS	US	i3-6100U	No	Intel HD 520	4GBx1	13.3" FHD (1920x1080) IPS	None	128GB SSD M.2	None	Intel 8260 ac, 2x2 + BT4.1	Black	720p	Non-backlit	Fingerprint Reader	dTPM1.2 + FW TPM2.0	3-cell (42Wh)	45W	Windows 10 Pro 64	3-year, Depot	03/16
20GJ000JUS	US	i5-6200U	No	Intel HD 520	4GBx1	13.3" FHD (1920x1080) IPS	None	512GB SSD M.2	None	Intel 8260 ac, 2x2 + BT4.1	Black	720p	Non-backlit	Fingerprint Reader	dTPM1.2 + FW TPM2.0	3-cell (42Wh)	45W	Windows 10 Pro 64	3-year, Depot	03/16
20GJ000KUS	US	i3-6100U	No	Intel HD 520	4GBx2	13.3" HD (1366x768)	None	128GB SSD M.2	None	Intel 8260 ac, 2x2 + BT4.1	Black	720p	Non-backlit	Fingerprint Reader	dTPM1.2 + FW TPM2.0	3-cell (42Wh)	45W	Windows 10 Pro 64	3-year, Depot	03/16
20GJ000LUS	US	Celeron 3855U	No	Intel HD 510	4GBx1	13.3" FHD (1920x1080) IPS	None	128GB SSD M.2	None	Intel 8260 ac, 2x2 + BT4.1	Black	720p	Non-backlit	Fingerprint Reader	dTPM 1.2	3-cell (42Wh)	45W	Windows 7 Pro 64	3-year, Depot	03/16
20GJ000MUS	US	Celeron 3855U	No	Intel HD 510	4GBx1	13.3" FHD (1920x1080) IPS	None	128GB SSD M.2	None	Intel 8260 ac, 2x2 + BT4.1	Black	720p	Non-backlit	Fingerprint Reader	dTPM 1.2	3-cell (42Wh)	45W	Windows 10 DG Windows 7 Pro 64	3-year, Depot	03/16
20GJ000NUS	US	i5-6200U	No	Intel HD 520	4GBx2	13.3" FHD (1920x1080) IPS	None	512GB SSD M.2	None	Intel 8260 ac, 2x2 + BT4.1	Black	720p	Non-backlit	Fingerprint Reader	dTPM1.2 + FW TPM2.0	3-cell (42Wh)	45W	Windows 10 Pro 64	3-year, Depot	03/16
20GJ000PUS	US	i5-6200U	No	Intel HD 520	4GBx2	13.3" HD (1366x768)	None	256GB SSD M.2 Opal2	None	Intel 8260 ac, 2x2 + BT4.1	Black	720p	Non-backlit	Fingerprint Reader	dTPM1.2 + FW TPM2.0	3-cell (42Wh)	45W	Windows 10 Pro 64	3-year, Depot	03/16
20GJ000QUS	US	Celeron 3855U	No	Intel HD 510	4GBx2	13.3" FHD (1920x1080) IPS	None	128GB SSD M.2	None	Intel 8260 ac, 2x2 + BT4.1	Black	720p	Non-backlit	Fingerprint Reader	dTPM1.2 + FW TPM2.0	3-cell (42Wh)	45W	Windows 10 Pro 64	3-year, Depot	03/16
20GJ000RUS	US	i5-6200U	No	Intel HD 520	4GBx2	13.3" HD (1366x768)	None	128GB SSD M.2	None	Intel 8260 ac, 2x2 + BT4.1	Silver	720p	Non-backlit	None	dTPM 1.2	3-cell (42Wh)	45W	Windows 10 DG Windows 7 Pro 64	3-year, Depot	03/16
20GJ000SUS	US	i5-6200U	No	Intel HD 520	4GBx1	13.3" FHD (1920x1080) IPS	None	128GB SSD M.2	None	Intel 8260 ac, 2x2 + BT4.1	Black	720p	Non-backlit	Fingerprint Reader	dTPM1.2 + FW TPM2.0	3-cell (42Wh)	45W	Windows 10 Pro 64	3-year, Depot	03/16
20GJ000TUS	US	i5-6200U	No	Intel HD 520	4GBx1	13.3" HD (1366x768)	None	128GB SSD M.2	None	Intel 8260 ac, 2x2 + BT4.1	Black	720p	Non-backlit	Fingerprint Reader	dTPM1.2 + FW TPM2.0	3-cell (42Wh)	45W	Windows 10 Pro 64	3-year, Depot	03/16

Model	Region	Processor	vPro	Graphics	Memory	Display	Multi-touch	Storage	Optical	WLAN + Bluetooth	Color	Camera	Keyboard	Fingerprint Reader	TPM	Battery (internal)	Power Adapter	Operating System	Warranty	Ann Date (m/y)
20GJ000UUS	US	i3-6100U	No	Intel HD 520	4GBx2	13.3" FHD (1920x1080) IPS	None	128GB SSD M.2	None	Intel 8260 ac, 2x2 + BT4.1	Silver	720p	Non-backlit	None	dTPM 1.2	3-cell (42Wh)	45W	Windows 10 DG Windows 7 Pro 64	3-year, Depot	03/16
20GJ000VUS	US	i5-6200U	No	Intel HD 520	4GBx1	13.3" HD (1366x768)	None	128GB SSD M.2	None	Intel 8260 ac, 2x2 + BT4.1	Black	720p	Non-backlit	Fingerprint Reader	dTPM1.2 + FW TPM2.0	3-cell (42Wh)	45W	Windows 10 Pro 64	3-year, Depot	03/16
20GJ000WUS	US	i3-6100U	No	Intel HD 520	4GBx2	13.3" FHD (1920x1080) IPS	None	256GB SSD M.2 Opal2	None	Intel 8260 ac, 2x2 + BT4.1	Black	720p	Non-backlit	Fingerprint Reader	dTPM1.2 + FW TPM2.0	3-cell (42Wh)	45W	Windows 10 Pro 64	3-year, Depot	03/16
20GJ000XUS	US	Celeron 3855U	No	Intel HD 510	4GBx1	13.3" FHD (1920x1080) IPS	None	128GB SSD M.2	None	Intel 8260 ac, 2x2 + BT4.1	Silver	720p	Non-backlit	None	dTPM 1.2	3-cell (42Wh)	45W	Windows 10 DG Windows 7 Pro 64	3-year, Depot	03/16
20GJ000YUS	US	i5-6200U	No	Intel HD 520	4GBx2	13.3" HD (1366x768)	None	128GB SSD M.2	None	Intel 8260 ac, 2x2 + BT4.1	Black	720p	Non-backlit	Fingerprint Reader	dTPM1.2 + FW TPM2.0	3-cell (42Wh)	45W	Windows 10 Pro 64	3-year, Depot	03/16
20GJ0010US	US	Celeron 3855U	No	Intel HD 510	4GBx1	13.3" HD (1366x768)	None	128GB SSD M.2	None	Intel 8260 ac, 2x2 + BT4.1	Silver	720p	Non-backlit	None	dTPM 1.2	3-cell (42Wh)	45W	Windows 10 DG Windows 7 Pro 64	3-year, Depot	03/16
20GJ0011US	US	i5-6200U	No	Intel HD 520	4GBx2	13.3" FHD (1920x1080) IPS	None	128GB SSD M.2	None	Intel 8260 ac, 2x2 + BT4.1	Silver	720p	Non-backlit	None	dTPM 1.2	3-cell (42Wh)	45W	Windows 10 DG Windows 7 Pro 64	3-year, Depot	03/16
20GJ0012US	US	i3-6100U	No	Intel HD 520	4GBx1	13.3" HD (1366x768)	None	128GB SSD M.2	None	Intel 8260 ac, 2x2 + BT4.1	Silver	720p	Non-backlit	None	dTPM 1.2	3-cell (42Wh)	45W	Windows 10 DG Windows 7 Pro 64	3-year, Depot	03/16
20GJ0013US	US	i5-6200U	No	Intel HD 520	4GBx1	13.3" FHD (1920x1080) IPS	None	256GB SSD M.2 Opal2	None	Intel 8260 ac, 2x2 + BT4.1	Black	720p	Non-backlit	Fingerprint Reader	dTPM1.2 + FW TPM2.0	3-cell (42Wh)	45W	Windows 10 Pro 64	3-year, Depot	03/16
20GJ0014US	US	i5-6200U	No	Intel HD 520	4GBx2	13.3" FHD (1920x1080) IPS	None	256GB SSD M.2 Opal2	None	Intel 8260 ac, 2x2 + BT4.1	Black	720p	Non-backlit	Fingerprint Reader	dTPM1.2 + FW TPM2.0	3-cell (42Wh)	45W	Windows 10 Pro 64	3-year, Depot	03/16
20GJ0015US	US	i3-6100U	No	Intel HD 520	4GBx1	13.3" HD (1366x768)	None	192GB SSD M.2	None	Intel 8260 ac, 2x2 + BT4.1	Black	720p	Non-backlit	Fingerprint Reader	dTPM1.2 + FW TPM2.0	3-cell (42Wh)	45W	Windows 10 Pro 64	3-year, Depot	03/16
20GJ0016US	US	i3-6100U	No	Intel HD 520	4GBx2	13.3" FHD (1920x1080) IPS	None	128GB SSD M.2	None	Intel 8260 ac, 2x2 + BT4.1	Black	720p	Non-backlit	Fingerprint Reader	dTPM1.2 + FW TPM2.0	3-cell (42Wh)	45W	Windows 10 Pro 64	3-year, Depot	03/16
20GJ0019US	US	i5-6300U	vPro	Intel HD 520	4GBx1	13.3" FHD (1920x1080) IPS	None	256GB SSD M.2 Opal2	None	Intel 8260 ac, 2x2 + BT4.1	Black	720p	Non-backlit	Fingerprint Reader	dTPM 1.2	3-cell (42Wh)	45W	Windows 10 DG Windows 7 Pro 64	3-year, Depot	03/16
20GJ0031US	US	i5-6200U	No	Intel HD 520	4GBx1	13.3" FHD (1920x1080) IPS	None	128GB SSD M.2	None	Intel 8260 ac, 2x2 + BT4.1	Black	720p	Non-backlit	Fingerprint Reader	dTPM 1.2	3-cell (42Wh)	45W	Windows 10 DG Windows 7 Pro 64	3-year, Depot	03/16
20GJ0039US	US	i5-6300U	vPro	Intel HD 520	4GBx1	13.3" FHD (1920x1080) IPS	None	128GB SSD M.2	None	Intel 8260 ac, 2x2 + BT4.1	Black	720p	Non-backlit	Fingerprint Reader	dTPM 1.2	3-cell (42Wh)	45W	Windows 10 DG Windows 7 Pro 64	3-year, Depot	03/16
20GJ003AUS	US	i5-6300U	vPro	Intel HD 520	4GBx1	13.3" HD (1366x768)	None	128GB SSD M.2	None	Intel 8260 ac, 2x2 + BT4.1	Black	720p	Non-backlit	Fingerprint Reader	dTPM 1.2	3-cell (42Wh)	45W	Windows 10 DG Windows 7 Pro 64	3-year, Depot	03/16
20GJ003BUS	US	i5-6300U	vPro	Intel HD 520	8GBx1	13.3" FHD (1920x1080) IPS	None	128GB SSD M.2	None	Intel 8260 ac, 2x2 + BT4.1	Black	720p	Non-backlit	Fingerprint Reader	dTPM 1.2	3-cell (42Wh)	45W	Windows 10 DG Windows 7 Pro 64	3-year, Depot	03/16
20GJ003CUS	US	i5-6300U	vPro	Intel HD 520	8GBx1	13.3" FHD (1920x1080) IPS	None	256GB SSD M.2 Opal2	None	Intel 8260 ac, 2x2 + BT4.1	Black	720p	Non-backlit	Fingerprint Reader	dTPM 1.2	3-cell (42Wh)	45W	Windows 10 DG Windows 7 Pro 64	3-year, Depot	03/16
20GJ003WUS	US	i3-6100U	No	Intel HD 520	4GBx1	13.3" FHD (1920x1080) IPS	None	128GB SSD M.2	None	Intel 8260 ac, 2x2 + BT4.1	Black	720p	Non-backlit	Fingerprint Reader	dTPM 1.2	3-cell (42Wh)	45W	Windows 10 DG Windows 7 Pro 64	3-year, Depot	03/16
20GJ003XUS	US	i5-6200U	No	Intel HD 520	4GBx1	13.3" HD (1366x768)	None	128GB SSD M.2	None	Intel 8260 ac, 2x2 + BT4.1	Black	720p	Non-backlit	Fingerprint Reader	dTPM 1.2	3-cell (42Wh)	45W	Windows 10 DG Windows 7 Pro 64	3-year, Depot	03/16

Model	Region	Processor	vPro	Graphics	Memory	Display	Multi-touch	Storage	Optical	WLAN + Bluetooth	Color	Camera	Keyboard	Fingerprint Reader	TPM	Battery (internal)	Power Adapter	Operating System	Warranty	Ann Date (m/y)
20GJ003YUS	US	i3-6100U	No	Intel HD 520	4GBx1	13.3" FHD (1920x1080) IPS	None	128GB SSD M.2	None	Intel 8260 ac, 2x2 + BT4.1	Black	720p	Non-backlit	Fingerprint Reader	dTPM 1.2	3-cell (42Wh)	45W	Windows 10 DG Windows 7 Pro 64	3-year, Depot	03/16
20GJ0048US	US	i5-6200U	No	Intel HD 520	8GBx1	13.3" FHD (1920x1080) IPS	None	256GB SSD M.2 Opal2	None	Intel 8260 ac, 2x2 + BT4.1	Black	720p	Non-backlit	Fingerprint Reader	dTPM1.2 + FW TPM2.0	3-cell (42Wh)	45W	Windows 10 Pro 64	1-year, Depot	06/16
20GJ0055US	US	i5-6200U	No	Intel HD 520	8GBx1	13.3" HD (1366x768)	None	256GB SSD M.2 Opal2	None	Intel 8260 ac, 2x2 + BT4.1	Black	720p	Non-backlit	Fingerprint Reader	dTPM1.2 + FW TPM2.0	3-cell (42Wh)	45W	Windows 10 Pro 64	1-year, Depot	06/16
20GJ005EUS	US	i3-6100U	No	Intel HD 520	4GBx1	13.3" HD (1366x768)	None	128GB SSD M.2	None	Intel 8260 ac, 2x2 + BT4.1	Black	720p	Non-backlit	Fingerprint Reader	dTPM1.2 + FW TPM2.0	3-cell (42Wh)	45W	Windows 10 Pro 64	1-year, Depot	06/16
20GJ005FUS	US	i5-6200U	No	Intel HD 520	4GBx1	13.3" HD (1366x768)	None	128GB SSD M.2	None	Intel 8260 ac, 2x2 + BT4.1	Black	720p	Non-backlit	Fingerprint Reader	dTPM1.2 + FW TPM2.0	3-cell (42Wh)	45W	Windows 10 Pro 64	1-year, Depot	06/16
20GJ005JUS	US	i5-6300U	vPro	Intel HD 520	8GBx1	13.3" FHD (1920x1080) IPS	None	256GB SSD M.2 Opal2	None	Intel 8260 ac, 2x2 + BT4.1	Silver	720p	Non-backlit	None	dTPM 1.2	3-cell (42Wh)	45W	Windows 10 DG Windows 7 Pro 64	3-year, Depot	04/16
20GJ005KUS	US	i5-6200U	No	Intel HD 520	8GBx1	13.3" FHD (1920x1080) IPS	None	256GB SSD M.2 Opal2	None	Intel 8260 ac, 2x2 + BT4.1	Silver	720p	Non-backlit	None	dTPM 1.2	3-cell (42Wh)	45W	Windows 10 DG Windows 7 Pro 64	3-year, Depot	04/16
20GJ005LUS	US	i5-6300U	vPro	Intel HD 520	8GBx2	13.3" FHD (1920x1080) IPS	None	512GB SSD M.2	None	Intel 8260 ac, 2x2 + BT4.1	Silver	720p	Non-backlit	None	dTPM 1.2	3-cell (42Wh)	45W	Windows 10 DG Windows 7 Pro 64	3-year, Depot	04/16
20GJ006MUS	US	i5-6300U	vPro	Intel HD 520	8GBx1	13.3" FHD (1920x1080) IPS	None	512GB SSD M.2	None	Intel 8260 ac, 2x2 + BT4.1	Black	720p	Non-backlit	Fingerprint Reader	dTPM1.2 + FW TPM2.0	3-cell (42Wh)	45W	Windows 10 Pro 64	3-year, Depot	10/16

Model	Region	Processor	vPro	Graphics	Memory	Display	Multi-touch	Storage	Optical	WLAN + Bluetooth	Color	Camera	Keyboard	Fingerprint Reader	TPM	Battery (internal)	Power Adapter	Operating System	Warranty	Ann Date (m/y)
20GJ000BUS	US	Celeron 3855U	No	Intel HD 510	4GBx1	13.3" HD (1366x768)	None	128GB SSD M.2	None	Intel 8260 ac, 2x2 + BT4.1	Black	720p	Non-backlit	Fingerprint Reader	dTPM1.2 + FW TPM2.0	3-cell (42Wh)	45W	Windows 10 Pro 64	3-year, Depot	03/16
20GJ000CUS	US	Celeron 3855U	No	Intel HD 510	4GBx1	13.3" FHD (1920x1080) IPS	None	128GB SSD M.2	None	Intel 8260 ac, 2x2 + BT4.1	Black	720p	Non-backlit	Fingerprint Reader	dTPM1.2 + FW TPM2.0	3-cell (42Wh)	45W	Windows 10 Pro 64	3-year, Depot	03/16



ThinkPad 13 (2nd Gen) Platform Specifications

Product Specifications Reference (PSREF)

Processor	Intel® Celeron® processor or 7th Generation Intel Core™ i3 / i5 / i7 Processor								Smart card reader	None
	Processor Number	# of Cores	# of Threads	Base Frequency	Max Turbo Frequency	Cache	Memory Types	Processor Graphics	Media reader	4-in-1 reader (MMC, SD, SDHC, SDXC)
	Cel 3865U	2	4	1.8 GHz	-	2MB	DDR4-2133	Intel HD Graphics 610	Ports	Three USB 3.1 Gen 1 / USB 3.0 (one Always On), one USB Type-C, HDMI, Lenovo OneLink+ connector
	i3-7100U			2.4 GHz	-	3MB		Intel HD Graphics 620		
	i5-7200U			2.5 GHz	3.1 GHz	3MB				
i5-7300U	2.6 GHz			3.5 GHz	3MB					
i7-7500U	2.7 GHz	3.5 GHz	4MB							
Graphics	Intel HD Graphics 610 or 620 in processor, supports external digital monitor via HDMI or USB Type-C; supports three independent displays; Max resolution: 1920x1080 (HDMI)@60Hz, 3840x2160 (USB Type-C)@60Hz								Camera	HD720p resolution, low light sensitive, fixed focus
Chipset	Intel SoC (System on Chip) platform								Audio support	HD Audio, Realtek® ALC3268 codec / stereo speakers, 2W x 2 / dual array microphone, combo audio/microphone jack
Memory	32GB max / 2133MHz DDR4, two DDR4 SO-DIMM sockets								Keyboard	6-row, multimedia Fn keys, optional LED backlight
Display	<i>Some:</i> 13.3" (338mm) HD (1366x768), anti-glare, LED backlight, 250 nits, 16:9 aspect ratio, 500:1 contrast ratio <i>Some:</i> 13.3" (338mm) FHD (1920x1080), anti-glare, LED backlight, IPS, 250 nits, 16:9 aspect ratio, 700:1 contrast ratio, 170° viewing angle								UltraNav™	TrackPoint® pointing device and buttonless Mylar surface touchpad, multi-touch
Multi-touch (opt)	On-cell touch, supports 10-finger gesture (FHD only)								Security	Power-on password, hard disk password, supervisor password, security keyhole
Storage	<i>Some:</i> M.2 SSD / SATA 6.0Gb/s (e.g. xxxG SSD) <i>Some:</i> M.2 SSD / PCIe NVMe, PCIe 3.0 x 4, 32Gb/s (e.g. xxxG SSD PCIe NVMe)								Security chip	Discrete TPM 2.0, TCG Certified
Optical	None								vPro (optional)	Intel vPro Technology
Ethernet	None								Fingerprint reader	Optional: swipe style fingerprint reader on the palm rest
WWAN	None								Battery	Integrated Lithium Polymer 3-cell (42Wh)
Dimensions	<i>WxDxH (silver):</i> 12.69" x 8.77" x 0.75"; 322.4mm x 222.8mm x 19.1mm <i>WxDxH (black):</i> 12.69" x 8.77" x 0.78"; 322.4mm x 222.8mm x 19.8mm								Max battery life	MobileMark® 2014: 14.56 hr
Weight	from 3.17 lb / 1.44 kg								AC adapter	45W AC adapter
Case color	Pure Black or Silver								Preload	<i>Some:</i> Windows® 10 Home 64 <i>Some:</i> Windows 10 Pro 64
Case material	<i>Black cover:</i> PC/ABS plastic; <i>Silver cover:</i> Aluminum									<ul style="list-style-type: none"> • Lenovo Companion • Lenovo Setting • Microsoft Office preloaded; purchase a product key to activate
									Limited warranty	<i>One of the following, configurable by model:</i> <ul style="list-style-type: none"> • 1-year depot repair service • 3-year/1-yr battery depot repair service • 3-year/1-yr battery limited onsite service²⁴
									Mil-Spec test	MIL-STD-810G military certification
									Environment	EPEAT™ Gold (US only); ENERGY STAR® 6.1; RoHS-compliant

ThinkPad 13 (2nd Gen) - TopSeller - 20J1

Product Specifications Reference (PSREF)

Model	Region	Processor	vPro	Graphics	Memory	Display	Multi-touch	Storage(HDD/SSD)	Optical	WLAN + Bluetooth	Color	Camera	Keyboard	Fingerprint Reader	TPM	Battery (internal)	Power Adapter	Operating System	Warranty	Ann Date (m/y)
20J10006US	US	i3-7100U	No	Intel HD 620	4GBx1	13.3" HD (1366x768)	None	128GB SSD M.2	None	Intel 8265 ac, 2x2 + BT4.1	Black	720p	Non-backlit	Fingerprint Reader	dTPM 2.0	3-cell (42Wh)	45W	Windows 10 Pro 64	1-year, Depot	12/16
20J1000AUS	US	i5-7200U	No	Intel HD 620	4GBx1	13.3" HD (1366x768)	None	256GB SSD M.2 Opal2	None	Intel 8265 ac, 2x2 + BT4.1	Black	720p	Non-backlit	Fingerprint Reader	dTPM 2.0	3-cell (42Wh)	45W	Windows 10 Pro 64	1-year, Depot	12/16
20J1000EUS	US	i5-7200U	No	Intel HD 620	8GBx1	13.3" HD (1366x768)	None	256GB SSD M.2 Opal2	None	Intel 8265 ac, 2x2 + BT4.1	Black	720p	Non-backlit	Fingerprint Reader	dTPM 2.0	3-cell (42Wh)	45W	Windows 10 Pro 64	1-year, Depot	12/16
20J1001BUS	US	i3-7100U	No	Intel HD 620	4GBx1	13.3" FHD (1920x1080) IPS	10-point Multi-touch	128GB SSD M.2	None	Intel 8265 ac, 2x2 + BT4.1	Black	720p	Non-backlit	Fingerprint Reader	dTPM 2.0	3-cell (42Wh)	45W	Windows 10 Pro 64	1-year, Depot	12/16
20J1001CUS	US	i5-7200U	No	Intel HD 620	8GBx1	13.3" FHD (1920x1080) IPS	10-point Multi-touch	256GB SSD M.2 Opal2	None	Intel 8265 ac, 2x2 + BT4.1	Black	720p	Backlit	Fingerprint Reader	dTPM 2.0	3-cell (42Wh)	45W	Windows 10 Pro 64	3-year, Depot	12/16
20J1001DUS	US	i5-7200U	No	Intel HD 620	4GBx1	13.3" FHD (1920x1080) IPS	10-point Multi-touch	128GB SSD M.2	None	Intel 8265 ac, 2x2 + BT4.1	Black	720p	Non-backlit	Fingerprint Reader	dTPM 2.0	3-cell (42Wh)	45W	Windows 10 Pro 64	1-year, Depot	12/16
20J1001EUS	US	i3-7100U	No	Intel HD 620	4GBx1	13.3" FHD (1920x1080) IPS	10-point Multi-touch	128GB SSD M.2	None	Intel 8265 ac, 2x2 + BT4.1	Silver	720p	Non-backlit	None	dTPM 2.0	3-cell (42Wh)	45W	Windows 10 Pro 64	1-year, Depot	12/16
20J1001FUS	US	i5-7200U	No	Intel HD 620	4GBx1	13.3" HD (1366x768)	None	128GB SSD M.2	None	Intel 8265 ac, 2x2 + BT4.1	Silver	720p	Non-backlit	None	dTPM 2.0	3-cell (42Wh)	45W	Windows 10 Pro 64	1-year, Depot	12/16
20J1001GUS	US	i5-7200U	No	Intel HD 620	8GBx1	13.3" FHD (1920x1080) IPS	10-point Multi-touch	256GB SSD M.2 Opal2	None	Intel 8265 ac, 2x2 + BT4.1	Silver	720p	Backlit	None	dTPM 2.0	3-cell (42Wh)	45W	Windows 10 Pro 64	3-year, Depot	12/16
20J1001HUS	US	i3-7100U	No	Intel HD 620	4GBx1	13.3" HD (1366x768)	None	128GB SSD M.2	None	Intel 8265 ac, 2x2 + BT4.1	Silver	720p	Non-backlit	None	dTPM 2.0	3-cell (42Wh)	45W	Windows 10 Pro 64	1-year, Depot	12/16
20J1001JUS	US	i5-7200U	No	Intel HD 620	8GBx1	13.3" FHD (1920x1080) IPS	10-point Multi-touch	256GB SSD M.2 Opal2	None	Intel 8265 ac, 2x2 + BT4.1	Silver	720p	Non-backlit	None	dTPM 2.0	3-cell (42Wh)	45W	Windows 10 Pro 64	1-year, Depot	12/16
20J10022US	US	i5-7200U	No	Intel HD 620	4GBx1	13.3" HD (1366x768)	None	180GB SSD M.2	None	Intel 8265 ac, 2x2 + BT4.1	Black	720p	Non-backlit	Fingerprint Reader	dTPM 2.0	3-cell (42Wh)	45W	Windows 10 Pro 64	1-year, Depot	01/17
20J10023US	US	i3-7100U	No	Intel HD 620	4GBx1	13.3" HD (1366x768)	None	180GB SSD M.2	None	Intel 8265 ac, 2x2 + BT4.1	Black	720p	Non-backlit	Fingerprint Reader	dTPM 2.0	3-cell (42Wh)	45W	Windows 10 Pro 64	1-year, Depot	01/17



ThinkPad 13 Chromebook Platform Specifications

Product Specifications Reference (PSREF)

Processor	Intel® Celeron® processor or 6th Generation Intel Core™ i3 / i5 Processor							Dimensions ³	<i>WxDxH:</i> 12.69" x 8.77" x 0.78"; 322.4mm x 222.8mm x 19.8mm
	Processor Number	# of Cores	# of Threads	Base Frequency	Max Turbo Frequency	Cache	Memory Types	Processor Graphics	Weight ² Case color Case material
	Cel 3855U	2	2	1.6 GHz	-	2MB	LPDDR3-1866	Intel HD graphics 510	Smart card reader Media reader
	i3-6100U		4	2.3 GHz	-	3MB		Intel HD graphics 520	4-in-1 reader (MMC, SD, SDHC, SDXC)
i5-6300U	4		2.4 GHz	3.0 GHz	3MB			Ports Two USB 3.0 (Always On), two USB Type-C	
Graphics	Intel HD Graphics 510 or 520 in processor, supports external digital monitor via USB Type-C; supports three independent displays; Max resolution: 3840X2160 (USB Type-C) @60Hz							Camera	HD720p resolution, low light sensitive, fixed focus
Chipset	Intel SoC (System on Chip) platform							Audio support	HD Audio, Nuvoton NAU88L25B codec / stereo speakers, 2W x 2 / dual array microphone, combo audio/microphone jack
Memory	4GB or 8GB / 1866MHz LPDDR3 / soldered to systemboard, no sockets							Keyboard	ThinkPad Chrome keyboard, 6-row, multimedia Fn keys
Display	<i>Some:</i> 13.3" (338mm) HD (1366x768), anti-glare, LED backlight, 200 nits, 16:9 aspect ratio, 500:1 contrast ratio <i>Some:</i> 13.3" (338mm) FHD (1920x1080), anti-glare, LED backlight, IPS, 220 nits, 16:9 aspect ratio, 700:1 contrast ratio, 170° viewing angle <i>Some:</i> 13.3" (338mm) FHD (1920x1080), glossy, LED backlight, IPS, multi-touch, 250 nits, 16:9 aspect ratio, 800:1 contrast ratio, 170° viewing angle							Touchpad	Buttonless touchpad below keyboard, multi-touch
Multi-touch (opt)	Capacitive-type multi-touch, supports 10-finger gesture							Security	Security keyhole
Storage	16GB or 32GB eMMC (embedded Multi Media Card) flash memory on board							Security chip	Discrete TPM 1.2, TCG Certified
Optical	None							vPro	None
Ethernet	None							Fingerprint reader	None
WLAN ⁴	11ac+BT, Intel Dual Band Wireless-AC 7265, 2x2, M.2 card							Battery	Integrated Lithium Polymer 3-cell (42Wh)
Bluetooth™	Bluetooth 4.0 wireless, integrated in Wi-Fi + Bluetooth combo adapter							Max battery life ¹⁰	13 hr
WWAN	None							AC adapter	USB Type-C 45-watt AC adapter
								Preload	Google Chrome OS
								Limited warranty ¹²	1-year depot repair service
								Mil-Spec test	MIL-STD-810G military certification
								Environment	EPEAT™ Gold (US only); ENERGY STAR® 6.1; RoHS-compliant

Model	Region	Processor	vPro	Graphics	Memory (Soldered)	Display	Multi-touch	Storage	Optical	WLAN + Bluetooth	Color	Camera	Keyboard	Fingerprint Reader	TPM	Battery (internal)	Power Adapter	Operating System	Warranty	Ann Date (m/y)
20GL0000US	US	Celeron 3855U	No	Intel HD 510	4GB Soldered	13.3" HD (1366x768) Anti-glare	None	16GB eMMC	None	Intel 7265 ac, 2x2 + BT4.0	Black	720p	Non-backlit	None	dTPM 1.2	3-cell (42Wh)	45W	Chrome OS	1-year, Depot	05/16
20GL0002US	US	i3-6100U	No	Intel HD 520	4GB Soldered	13.3" HD (1366x768) Anti-glare	None	16GB eMMC	None	Intel 7265 ac, 2x2 + BT4.0	Black	720p	Non-backlit	None	dTPM 1.2	3-cell (42Wh)	45W	Chrome OS	1-year, Depot	05/16
20GL0004US	US	i5-6300U	No	Intel HD 520	8GB Soldered	13.3" FHD (1920x1080) IPS Anti-glare	None	32GB eMMC	None	Intel 7265 ac, 2x2 + BT4.0	Black	720p	Non-backlit	None	dTPM 1.2	3-cell (42Wh)	45W	Chrome OS	1-year, Depot	05/16
20GL0005US	US	i5-6300U	No	Intel HD 520	8GB Soldered	13.3" HD (1366x768) Anti-glare	None	32GB eMMC	None	Intel 7265 ac, 2x2 + BT4.0	Black	720p	Non-backlit	None	dTPM 1.2	3-cell (42Wh)	45W	Chrome OS	1-year, Depot	05/16
20GL0006US	US	Celeron 3855U	No	Intel HD 510	4GB Soldered	13.3" FHD (1920x1080) IPS Glossy	10-point Multi-touch	16GB eMMC	None	Intel 7265 ac, 2x2 + BT4.0	Black	720p	Non-backlit	None	dTPM 1.2	3-cell (42Wh)	45W	Chrome OS	1-year, Depot	10/16
20GL0007US	US	i5-6300U	No	Intel HD 520	8GB Soldered	13.3" FHD (1920x1080) IPS Glossy	10-point Multi-touch	32GB eMMC	None	Intel 7265 ac, 2x2 + BT4.0	Black	720p	Non-backlit	None	dTPM 1.2	3-cell (42Wh)	45W	Chrome OS	1-year, Depot	10/16
20GL0008US	US	i3-6100U	No	Intel HD 520	4GB Soldered	13.3" FHD (1920x1080) IPS Glossy	10-point Multi-touch	16GB eMMC	None	Intel 7265 ac, 2x2 + BT4.0	Black	720p	Non-backlit	None	dTPM 1.2	3-cell (42Wh)	45W	Chrome OS	1-year, Depot	10/16



ThinkPad E450 Platform Specifications

Product Specifications Reference (PSREF)

Processor	4th or 5th Generation Intel® Core™ i3 / i5 / i7 Processor								Multicard Reader Ports	4-in-1 reader (MMC, SD, SDHC, SDXC)	
	Processor Number	# of Cores	# of Threads	Base Frequency	Max Turbo Frequency	Cache	Memory speed	Processor Graphics		Two USB 3.0, one USB 2.0 (Always On), Ethernet (RJ-45), external monitor (HDMI), Lenovo OneLink connector	
	i3-4005U	2	4	1.7 GHz	-	3MB	DDR3L-1600	HD4400		None	
	i3-5005U	2	4	2.0 GHz	-	3MB		HD5500		Camera	
	i5-5200U	2	4	2.2 GHz	2.7 GHz	3MB		HD5500		<i>Some:</i> 0.3-megapixel, fixed focus	
i7-5500U	2	4	2.4 GHz	3.0 GHz	4MB	HD5500		<i>Some:</i> HD720p resolution, fixed focus			
Graphics	Intel HD Graphics in processor only, or AMD Radeon R5 M240 Graphics, 1GB DDR3 memory, AMD Radeon R7 M260 Graphics, 2GB DDR3 memory, digital monitor support via HDMI™ (supporting HDCP to output protected content); supports dual independent display Max resolution: 1920x1080 (HDMI) @60Hz								Keyboard	6-row, spill-resistant, multimedia Fn keys	
Chipset Memory	Intel SoC (System on Chip) platform 16GB max ⁷ / PC3-12800 1600MHz DDR3L, non-parity, dual-channel capable, two 204-pin SO-DIMM sockets								UltraNav™	TrackPoint® pointing device and multi-touch with 3+2 buttons click pad	
	Display	Some: 14.0" (355mm) HD (1366x768) color, anti-glare, LED backlight, 200 nits, 16:9 aspect ratio								ThinkLight™	None
Multi-touch		Some: 14.0" (355mm) FHD (1920x1080) color, anti-glare, LED backlight, 220 nits, 16:9 aspect ratio								Security	Power-on password, hard disk password, supervisor password, security keyhole
	Storage	Some: SSD / SATA 6.0Gb/s, 2.5" wide, 7mm high, removable, upgradable								Security chip	TPM : Trusted Platform Module, TCG 1.2-compliant
Optical M.2 SSD		Some: HDD / SATA 6.0Gb/s, 2.5" wide, removable, upgradable, Shock Mounted Hard Drive, Active Protection System™								vPro	None
	Ethernet Bluetooth™	Some: Hybrid drive with 8GB NAND flash memory								Fingerprint reader	<i>Some:</i> Fingerprint reader on the keyboard bezel, swipe sensor
WLAN		Intel WGI218V Gigabit Ethernet Connection								NFC	None
	WWAN	Bluetooth 4.0 wireless, integrated in Wi-Fi + Bluetooth combo adapter								Battery type	Li-Ion 6-cell (47Wh)
SIM card		<i>One of the following, configurable by model:</i>								Battery life	6-cell (47Wh): up to 9.0 hr
	Smart Card Read ExpressCard	<ul style="list-style-type: none"> Intel Wireless-AC 3160, 1x1, Wi-Fi + Bluetooth combo adapter, M.2 Card Intel Dual Band Wireless-AC 7265, 2x2, Wi-Fi + BT combo adapter, M.2 Card RTL8723BE, Realtek 11b/g/n, 1x1, Wi-Fi + Bluetooth combo adapter, M.2 Card BCM43162, Broadcom 11-AC, 1x1, Wi-Fi + BT combo adapter, M.2 Card 								AC adapter	<i>Some:</i> 45-watt AC adapter (Integrated Graphics)
Dimensions Weight Case color Case material		None								Preload	<i>Some:</i> No operating system
	None								<i>Some:</i> Windows® 7 Professional 64 preinstalled through downgrade rights in Windows 8.1 Pro 64-bit		
ExpressCard	None								Norton™ Internet Security (30 days of virus definitions)	<ul style="list-style-type: none"> Lenovo Solution Center Lenovo SHAREit Lenovo Companion ThinkVantage System Update Evernote Maxthon Cloud Browser Norton Studio Microsoft Office preloaded; purchase a product key to activate Norton Internet Security (30 days of virus definitions) 	
	None									<ul style="list-style-type: none"> Lenovo Solution Center Lenovo SHAREit Lenovo Companion Microsoft Office preloaded; purchase a product key to activate McAfee LiveSafe (30 days of virus definitions) 	
ExpressCard	None								Limited warranty	1-year - depot repair service / service upgrades available	
	None									Environment	EPEAT™ Gold; ENERGY STAR®; RoHS-compliant

Model	Region	Processor	vPro	Graphics	Memory	Display	Multi-touch	Storage(HDD/SSD)	Optical	WLAN + Bluetooth	WWAN	SIM Card	Color	Case Material	Camera	Keyboard	Fingerprint Reader	TPM	Battery	Power Adapter	Operating System	Warranty	Ann Date (m/y)
20DC003FUS	US	i3-4005U	No	Intel HD 4400	4GBx1	14" HD (1366x768)	None	500GB 7200rpm	None	Intel 3160 ac, 1x1 + BT4.0	None	None	Black	PC/ABS	720p	Non-backlit	None	dTPM 1.2	6-cell (47Wh)	45W	Win8.1 64-bit	1-year, Depot	01/15
20DC003JUS	US	i3-4005U	No	Intel HD 4400	4GBx1	14" HD (1366x768)	None	500GB 7200rpm	None	Intel 3160 ac, 1x1 + BT4.0	None	None	Black	PC/ABS	720p	Non-backlit	None	dTPM 1.2	6-cell (47Wh)	45W	Win8.1 Pro 64-bit	1-year, Depot	01/15
20DC003KUS	US	i3-4005U	No	Intel HD 4400	8GBx1	14" HD (1366x768)	None	500GB 7200rpm	None	Intel 3160 ac, 1x1 + BT4.0	None	None	Black	PC/ABS	720p	Non-backlit	Fingerprint Reader	dTPM 1.2	6-cell (47Wh)	45W	Win8.1 Pro 64-bit	1-year, Depot	01/15
20DC003LUS	US	i3-4005U	No	Intel HD 4400	8GBx1	14" HD (1366x768)	None	1TB 5400rpm	None	Intel 3160 ac, 1x1 + BT4.0	None	None	Black	PC/ABS	720p	Non-backlit	Fingerprint Reader	dTPM 1.2	6-cell (47Wh)	45W	Win8.1 Pro 64-bit	1-year, Depot	01/15
20DC003MUS	US	i3-5005U	No	Intel HD 5500	4GBx1	14" HD (1366x768)	None	500GB 7200rpm	None	Intel 3160 ac, 1x1 + BT4.0	None	None	Black	PC/ABS	720p	Non-backlit	Fingerprint Reader	dTPM 1.2	6-cell (47Wh)	45W	Win8.1 64-bit	1-year, Depot	01/15
20DC003NUS	US	i3-5005U	No	Intel HD 5500	4GBx1	14" HD (1366x768)	None	500GB 7200rpm	None	Intel 3160 ac, 1x1 + BT4.0	None	None	Black	PC/ABS	720p	Non-backlit	Fingerprint Reader	dTPM 1.2	6-cell (47Wh)	45W	Win8.1 Pro 64-bit	1-year, Depot	01/15
20DC003PUS	US	i3-5005U	No	Intel HD 5500	4GBx1	14" HD (1366x768)	None	1TB 5400rpm	None	Intel 3160 ac, 1x1 + BT4.0	None	None	Black	PC/ABS	720p	Non-backlit	Fingerprint Reader	dTPM 1.2	6-cell (47Wh)	45W	Win8.1 Pro 64-bit	1-year, Depot	01/15
20DC003QUS	US	i3-5005U	No	Intel HD 5500	8GBx1	14" HD (1366x768)	None	500GB 7200rpm	None	Intel 3160 ac, 1x1 + BT4.0	None	None	Black	PC/ABS	720p	Non-backlit	Fingerprint Reader	dTPM 1.2	6-cell (47Wh)	45W	Win8.1 Pro 64-bit	1-year, Depot	01/15
20DC003RUS	US	i3-5005U	No	Intel HD 5500	8GBx1	14" HD (1366x768)	None	1TB 5400rpm	None	Intel 3160 ac, 1x1 + BT4.0	None	None	Black	PC/ABS	720p	Non-backlit	Fingerprint Reader	dTPM 1.2	6-cell (47Wh)	45W	Win8.1 Pro 64-bit	1-year, Depot	01/15
20DC003SUS	US	i5-5200U	No	Intel HD 5500	4GBx1	14" HD (1366x768)	None	500GB 7200rpm	None	Intel 3160 ac, 1x1 + BT4.0	None	None	Black	PC/ABS	720p	Non-backlit	Fingerprint Reader	dTPM 1.2	6-cell (47Wh)	45W	Win8.1 Pro 64-bit	1-year, Depot	01/15
20DC003TUS	US	i5-5200U	No	Intel HD 5500	4GBx1	14" HD (1366x768)	None	1TB 5400rpm	None	Intel 3160 ac, 1x1 + BT4.0	None	None	Black	PC/ABS	720p	Non-backlit	Fingerprint Reader	dTPM 1.2	6-cell (47Wh)	45W	Win8.1 Pro 64-bit	1-year, Depot	01/15
20DC003UUS	US	i5-5200U	No	Intel HD 5500	8GBx1	14" HD (1366x768)	None	500GB 7200rpm	None	Intel 3160 ac, 1x1 + BT4.0	None	None	Black	PC/ABS	720p	Non-backlit	Fingerprint Reader	dTPM 1.2	6-cell (47Wh)	45W	Win8.1 Pro 64-bit	1-year, Depot	01/15
20DC003VUS	US	i5-5200U	No	Intel HD 5500	8GBx1	14" HD (1366x768)	None	1TB 5400rpm	None	Intel 3160 ac, 1x1 + BT4.0	None	None	Black	PC/ABS	720p	Non-backlit	Fingerprint Reader	dTPM 1.2	6-cell (47Wh)	45W	Win8.1 Pro 64-bit	1-year, Depot	01/15
20DC003WUS	US	i3-4005U	No	Intel HD 4400	4GBx1	14" HD (1366x768)	None	500GB 7200rpm	None	Intel 3160 ac, 1x1 + BT4.0	None	None	Black	PC/ABS	720p	Non-backlit	Fingerprint Reader	dTPM 1.2	6-cell (47Wh)	45W	Win8.1 DG Win7 Pro 64	1-year, Depot	01/15
20DC003XUS	US	i5-5200U	No	Intel HD 5500	4GBx1	14" HD (1366x768)	None	128GB SSD	None	Intel 7265 ac, 2x2 + BT4.0	None	None	Black	PC/ABS	720p	Non-backlit	Fingerprint Reader	dTPM 1.2	6-cell (47Wh)	45W	Win8.1 DG Win7 Pro 64	1-year, Depot	01/15
20DC003YUS	US	i7-5500U	No	AMD R7 M260 2GB	8GBx1	14" HD (1366x768)	None	128GB SSD	None	Intel 7265 ac, 2x2 + BT4.0	None	None	Black	PC/ABS	720p	Non-backlit	Fingerprint Reader	None	6-cell (47Wh)	65W	Win8.1 DG Win7 Pro 64	1-year, Depot	01/15
20DC0040US	US	i3-4005U	No	Intel HD 4400	4GBx1	14" HD (1366x768)	None	500GB 7200rpm	None	Intel 3160 ac, 1x1 + BT4.0	None	None	Black	PC/ABS	720p	Non-backlit	None	dTPM 1.2	6-cell (47Wh)	45W	Win8.1 DG Win7 Pro 64	1-year, Depot	01/15
20DC0041US	US	i3-4005U	No	Intel HD 4400	4GBx1	14" HD (1366x768)	None	1TB 5400rpm	None	Intel 3160 ac, 1x1 + BT4.0	None	None	Black	PC/ABS	720p	Non-backlit	Fingerprint Reader	dTPM 1.2	6-cell (47Wh)	45W	Win8.1 DG Win7 Pro 64	1-year, Depot	01/15
20DC0042US	US	i3-4005U	No	Intel HD 4400	8GBx1	14" HD (1366x768)	None	500GB 7200rpm	None	Intel 3160 ac, 1x1 + BT4.0	None	None	Black	PC/ABS	720p	Non-backlit	Fingerprint Reader	dTPM 1.2	6-cell (47Wh)	45W	Win8.1 DG Win7 Pro 64	1-year, Depot	01/15
20DC0043US	US	i3-4005U	No	Intel HD 4400	8GBx1	14" HD (1366x768)	None	1TB 5400rpm	None	Intel 3160 ac, 1x1 + BT4.0	None	None	Black	PC/ABS	720p	Non-backlit	Fingerprint Reader	dTPM 1.2	6-cell (47Wh)	45W	Win8.1 DG Win7 Pro 64	1-year, Depot	01/15

Model	Region	Processor	vPro	Graphics	Memory	Display	Multi-touch	Storage(HDD/SSD)	Optical	WLAN + Bluetooth	WWAN	SIM Card	Color	Case Material	Camera	Keyboard	Fingerprint Reader	TPM	Battery	Power Adapter	Operating System	Warranty	Ann Date (m/y)
20DC0044US	US	i3-5005U	No	Intel HD 5500	4GBx1	14" HD (1366x768)	None	500GB 7200rpm	None	Intel 3160 ac, 1x1 + BT4.0	None	None	Black	PC/ABS	720p	Non-backlit	Fingerprint Reader	dTPM 1.2	6-cell (47Wh)	45W	Win8.1 DG Win7 Pro 64	1-year, Depot	01/15
20DC0045US	US	i3-5005U	No	Intel HD 5500	4GBx1	14" HD (1366x768)	None	500GB 7200rpm	None	Intel 7265 ac, 2x2 + BT4.0	None	None	Black	PC/ABS	720p	Non-backlit	Fingerprint Reader	dTPM 1.2	6-cell (47Wh)	45W	Win8.1 DG Win7 Pro 64	1-year, Depot	01/15
20DC0046US	US	i3-5005U	No	Intel HD 5500	4GBx1	14" HD (1366x768)	None	1TB 5400rpm	None	Intel 3160 ac, 1x1 + BT4.0	None	None	Black	PC/ABS	720p	Non-backlit	Fingerprint Reader	dTPM 1.2	6-cell (47Wh)	45W	Win8.1 DG Win7 Pro 64	1-year, Depot	01/15
20DC0047US	US	i3-5005U	No	Intel HD 5500	8GBx1	14" HD (1366x768)	None	500GB 7200rpm	None	Intel 3160 ac, 1x1 + BT4.0	None	None	Black	PC/ABS	720p	Non-backlit	Fingerprint Reader	dTPM 1.2	6-cell (47Wh)	45W	Win8.1 DG Win7 Pro 64	1-year, Depot	01/15
20DC0048US	US	i3-5005U	No	Intel HD 5500	8GBx1	14" HD (1366x768)	None	500GB 7200rpm	None	Intel 7265 ac, 2x2 + BT4.0	None	None	Black	PC/ABS	720p	Non-backlit	Fingerprint Reader	dTPM 1.2	6-cell (47Wh)	45W	Win8.1 DG Win7 Pro 64	1-year, Depot	01/15
20DC0049US	US	i3-5005U	No	Intel HD 5500	8GBx1	14" HD (1366x768)	None	1TB 5400rpm	None	Intel 3160 ac, 1x1 + BT4.0	None	None	Black	PC/ABS	720p	Non-backlit	Fingerprint Reader	dTPM 1.2	6-cell (47Wh)	45W	Win8.1 DG Win7 Pro 64	1-year, Depot	01/15
20DC004CUS	US	i5-5200U	No	Intel HD 5500	4GBx1	14" HD (1366x768)	None	500GB 7200rpm	None	Intel 3160 ac, 1x1 + BT4.0	None	None	Black	PC/ABS	720p	Non-backlit	Fingerprint Reader	dTPM 1.2	6-cell (47Wh)	45W	Win8.1 DG Win7 Pro 64	1-year, Depot	01/15
20DC004DUS	US	i5-5200U	No	Intel HD 5500	4GBx1	14" HD (1366x768)	None	500GB 7200rpm	None	Intel 7265 ac, 2x2 + BT4.0	None	None	Black	PC/ABS	720p	Non-backlit	Fingerprint Reader	dTPM 1.2	6-cell (47Wh)	45W	Win8.1 DG Win7 Pro 64	1-year, Depot	01/15
20DC004EUS	US	i5-5200U	No	Intel HD 5500	4GBx1	14" FHD (1920x1080)	None	500GB 7200rpm	None	Intel 7265 ac, 2x2 + BT4.0	None	None	Black	PC/ABS	720p	Non-backlit	Fingerprint Reader	dTPM 1.2	6-cell (47Wh)	45W	Win8.1 DG Win7 Pro 64	1-year, Depot	01/15
20DC004FUS	US	i5-5200U	No	Intel HD 5500	4GBx1	14" FHD (1920x1080)	None	128GB SSD	None	Intel 7265 ac, 2x2 + BT4.0	None	None	Black	PC/ABS	720p	Non-backlit	Fingerprint Reader	dTPM 1.2	6-cell (47Wh)	45W	Win8.1 DG Win7 Pro 64	1-year, Depot	01/15
20DC004GUS	US	i5-5200U	No	Intel HD 5500	4GBx1	14" HD (1366x768)	None	1TB 5400rpm	None	Intel 3160 ac, 1x1 + BT4.0	None	None	Black	PC/ABS	720p	Non-backlit	Fingerprint Reader	dTPM 1.2	6-cell (47Wh)	45W	Win8.1 DG Win7 Pro 64	1-year, Depot	01/15
20DC004HUS	US	i5-5200U	No	Intel HD 5500	4GBx1	14" HD (1366x768)	None	1TB 5400rpm	None	Intel 7265 ac, 2x2 + BT4.0	None	None	Black	PC/ABS	720p	Non-backlit	Fingerprint Reader	dTPM 1.2	6-cell (47Wh)	45W	Win8.1 DG Win7 Pro 64	1-year, Depot	01/15
20DC004JUS	US	i5-5200U	No	Intel HD 5500	4GBx1	14" FHD (1920x1080)	None	1TB 5400rpm	None	Intel 7265 ac, 2x2 + BT4.0	None	None	Black	PC/ABS	720p	Non-backlit	Fingerprint Reader	dTPM 1.2	6-cell (47Wh)	45W	Win8.1 DG Win7 Pro 64	1-year, Depot	01/15
20DC004KUS	US	i5-5200U	No	Intel HD 5500	8GBx1	14" HD (1366x768)	None	500GB 7200rpm	None	Intel 3160 ac, 1x1 + BT4.0	None	None	Black	PC/ABS	720p	Non-backlit	Fingerprint Reader	dTPM 1.2	6-cell (47Wh)	45W	Win8.1 DG Win7 Pro 64	1-year, Depot	01/15
20DC004LUS	US	i5-5200U	No	Intel HD 5500	8GBx1	14" HD (1366x768)	None	500GB 7200rpm	None	Intel 7265 ac, 2x2 + BT4.0	None	None	Black	PC/ABS	720p	Non-backlit	Fingerprint Reader	dTPM 1.2	6-cell (47Wh)	45W	Win8.1 DG Win7 Pro 64	1-year, Depot	01/15
20DC004MUS	US	i5-5200U	No	Intel HD 5500	8GBx1	14" FHD (1920x1080)	None	500GB 7200rpm	None	Intel 7265 ac, 2x2 + BT4.0	None	None	Black	PC/ABS	720p	Non-backlit	Fingerprint Reader	dTPM 1.2	6-cell (47Wh)	45W	Win8.1 DG Win7 Pro 64	1-year, Depot	01/15
20DC004NUS	US	i5-5200U	No	Intel HD 5500	8GBx1	14" HD (1366x768)	None	128GB SSD	None	Intel 7265 ac, 2x2 + BT4.0	None	None	Black	PC/ABS	720p	Non-backlit	Fingerprint Reader	dTPM 1.2	6-cell (47Wh)	45W	Win8.1 DG Win7 Pro 64	1-year, Depot	01/15
20DC004PUS	US	i5-5200U	No	Intel HD 5500	8GBx1	14" FHD (1920x1080)	None	128GB SSD	None	Intel 7265 ac, 2x2 + BT4.0	None	None	Black	PC/ABS	720p	Non-backlit	Fingerprint Reader	dTPM 1.2	6-cell (47Wh)	45W	Win8.1 DG Win7 Pro 64	1-year, Depot	01/15
20DC004QUS	US	i5-5200U	No	Intel HD 5500	8GBx1	14" HD (1366x768)	None	1TB 5400rpm	None	Intel 3160 ac, 1x1 + BT4.0	None	None	Black	PC/ABS	720p	Non-backlit	Fingerprint Reader	dTPM 1.2	6-cell (47Wh)	45W	Win8.1 DG Win7 Pro 64	1-year, Depot	01/15
20DC004SUS	US	i5-5200U	No	Intel HD 5500	8GBx1	14" HD (1366x768)	None	1TB 5400rpm	None	Intel 7265 ac, 2x2 + BT4.0	None	None	Black	PC/ABS	720p	Non-backlit	Fingerprint Reader	dTPM 1.2	6-cell (47Wh)	45W	Win8.1 DG Win7 Pro 64	1-year, Depot	01/15

Model	Region	Processor	vPro	Graphics	Memory	Display	Multi-touch	Storage(HDD/SSD)	Optical	WLAN + Bluetooth	WWAN	SIM Card	Color	Case Material	Camera	Keyboard	Fingerprint Reader	TPM	Battery	Power Adapter	Operating System	Warranty	Ann Date (m/y)
20DC004TUS	US	i5-5200U	No	Intel HD 5500	8GBx1	14" FHD (1920x1080)	None	1TB 5400rpm	None	Intel 7265 ac, 2x2 + BT4.0	None	None	Black	PC/ABS	720p	Non-backlit	Fingerprint Reader	dTPM 1.2	6-cell (47Wh)	45W	Win8.1 DG Win7 Pro 64	1-year, Depot	01/15
20DC004UUS	US	i7-5500U	No	AMD R7 M260 2GB	4GBx1	14" FHD (1920x1080)	None	500GB 7200rpm	None	Intel 7265 ac, 2x2 + BT4.0	None	None	Black	PC/ABS	720p	Non-backlit	Fingerprint Reader	None	6-cell (47Wh)	65W	Win8.1 DG Win7 Pro 64	1-year, Depot	01/15
20DC004VUS	US	i7-5500U	No	AMD R7 M260 2GB	4GBx1	14" FHD (1920x1080)	None	128GB SSD	None	Intel 7265 ac, 2x2 + BT4.0	None	None	Black	PC/ABS	720p	Non-backlit	Fingerprint Reader	None	6-cell (47Wh)	65W	Win8.1 DG Win7 Pro 64	1-year, Depot	01/15
20DC004WUS	US	i7-5500U	No	AMD R7 M260 2GB	4GBx1	14" HD (1366x768)	None	1TB 5400rpm	None	Intel 7265 ac, 2x2 + BT4.0	None	None	Black	PC/ABS	720p	Non-backlit	Fingerprint Reader	None	6-cell (47Wh)	65W	Win8.1 DG Win7 Pro 64	1-year, Depot	01/15
20DC004XUS	US	i7-5500U	No	AMD R7 M260 2GB	4GBx1	14" FHD (1920x1080)	None	1TB 5400rpm	None	Intel 7265 ac, 2x2 + BT4.0	None	None	Black	PC/ABS	720p	Non-backlit	Fingerprint Reader	None	6-cell (47Wh)	65W	Win8.1 DG Win7 Pro 64	1-year, Depot	01/15
20DC004YUS	US	i7-5500U	No	AMD R7 M260 2GB	8GBx1	14" HD (1366x768)	None	500GB 7200rpm	None	Intel 7265 ac, 2x2 + BT4.0	None	None	Black	PC/ABS	720p	Non-backlit	Fingerprint Reader	None	6-cell (47Wh)	65W	Win8.1 DG Win7 Pro 64	1-year, Depot	01/15
20DC0050US	US	i7-5500U	No	AMD R7 M260 2GB	8GBx1	14" FHD (1920x1080)	None	128GB SSD	None	Intel 7265 ac, 2x2 + BT4.0	None	None	Black	PC/ABS	720p	Non-backlit	Fingerprint Reader	None	6-cell (47Wh)	65W	Win8.1 DG Win7 Pro 64	1-year, Depot	01/15
20DC0051US	US	i7-5500U	No	AMD R7 M260 2GB	8GBx1	14" FHD (1920x1080)	None	1TB 5400rpm	None	Intel 7265 ac, 2x2 + BT4.0	None	None	Black	PC/ABS	720p	Non-backlit	Fingerprint Reader	None	6-cell (47Wh)	65W	Win8.1 DG Win7 Pro 64	1-year, Depot	01/15
20DC0099US	US	i7-5500U	No	AMD R7 M260 2GB	4GBx1	14" HD (1366x768)	None	500GB 7200rpm	None	Intel 7265 ac, 2x2 + BT4.0	None	None	Black	PC/ABS	720p	Non-backlit	Fingerprint Reader	None	6-cell (47Wh)	65W	Win8.1 DG Win7 Pro 64	1-year, Depot	01/15
20DC00AVUS	US	i3-4005U	No	Intel HD 4400	4GBx1	14" HD (1366x768)	None	500GB 7200rpm	None	Intel 3160 ac, 1x1 + BT4.0	None	None	Black	PC/ABS	720p	Non-backlit	Fingerprint Reader	dTPM 1.2	6-cell (47Wh)	45W	Win10 DG Win7 Pro 64	1-year, Depot	07/15
20DC00AWUS	US	i7-5500U	No	AMD R7 M260 2GB	4GBx1	14" FHD (1920x1080)	None	500GB 7200rpm	None	Intel 7265 ac, 2x2 + BT4.0	None	None	Black	PC/ABS	720p	Non-backlit	Fingerprint Reader	None	6-cell (47Wh)	65W	Win10 Pro 64	1-year, Depot	07/15
20DC00AXUS	US	i7-5500U	No	AMD R7 M260 2GB	4GBx1	14" FHD (1920x1080)	None	500GB 7200rpm	None	Intel 7265 ac, 2x2 + BT4.0	None	None	Black	PC/ABS	720p	Non-backlit	Fingerprint Reader	None	6-cell (47Wh)	65W	Win10 DG Win7 Pro 64	1-year, Depot	07/15
20DC00AYUS	US	i7-5500U	No	AMD R7 M260 2GB	8GBx1	14" FHD (1920x1080)	None	192GB SSD	None	Intel 7265 ac, 2x2 + BT4.0	None	None	Black	PC/ABS	720p	Non-backlit	Fingerprint Reader	None	6-cell (47Wh)	65W	Win10 Pro 64	1-year, Depot	07/15
20DC00B0US	US	i5-5200U	No	Intel HD 5500	4GBx1	14" HD (1366x768)	None	500GB 7200rpm	None	Intel 3160 ac, 1x1 + BT4.0	None	None	Black	PC/ABS	720p	Non-backlit	Fingerprint Reader	dTPM 1.2	6-cell (47Wh)	45W	Win10 DG Win7 Pro 64	1-year, Depot	07/15
20DC00B1US	US	i5-5200U	No	Intel HD 5500	4GBx1	14" HD (1366x768)	None	500GB 7200rpm	None	Intel 3160 ac, 1x1 + BT4.0	None	None	Black	PC/ABS	720p	Non-backlit	Fingerprint Reader	dTPM 1.2	6-cell (47Wh)	45W	Win10 Pro 64	1-year, Depot	07/15
20DC00B2US	US	i3-4005U	No	Intel HD 4400	4GBx1	14" HD (1366x768)	None	500GB 7200rpm	None	Intel 3160 ac, 1x1 + BT4.0	None	None	Black	PC/ABS	720p	Non-backlit	Fingerprint Reader	dTPM 1.2	6-cell (47Wh)	45W	Win10 Pro 64	1-year, Depot	07/15
20DC00BVUS	US	i3-5005U	No	Intel HD 5500	4GBx1	14" HD (1366x768)	None	500GB 7200rpm	None	Intel 3160 ac, 1x1 + BT4.0	None	None	Black	PC/ABS	0.3MP	Non-backlit	None	dTPM 1.2	6-cell (47Wh)	45W	Win10 Pro 64	1-year, Depot	08/15
20DC00BWUS	US	i3-5005U	No	Intel HD 5500	4GBx1	14" HD (1366x768)	None	500GB 7200rpm	None	Intel 3160 ac, 1x1 + BT4.0	None	None	Black	PC/ABS	720p	Non-backlit	Fingerprint Reader	dTPM 1.2	6-cell (47Wh)	45W	Win10 Pro 64	1-year, Depot	08/15
20DC00BXUS	US	i3-5005U	No	Intel HD 5500	4GBx1	14" HD (1366x768)	None	500GB 7200rpm	None	Intel 3160 ac, 1x1 + BT4.0	None	None	Black	PC/ABS	720p	Non-backlit	Fingerprint Reader	dTPM 1.2	6-cell (47Wh)	45W	Win10 DG Win7 Pro 64	1-year, Depot	08/15
20DC00BYUS	US	i3-5005U	No	Intel HD 5500	4GBx1	14" HD (1366x768)	None	500GB 7200rpm	None	Intel 3160 ac, 1x1 + BT4.0	None	None	Black	PC/ABS	0.3MP	Non-backlit	None	dTPM 1.2	6-cell (47Wh)	45W	Win10 DG Win7 Pro 64	1-year, Depot	08/15

Model	Region	Processor	vPro	Graphics	Memory	Display	Multi-touch	Storage(HDD/SSD)	Optical	WLAN + Bluetooth	WWAN	SIM Card	Color	Case Material	Camera	Keyboard	Fingerprint Reader	TPM	Battery	Power Adapter	Operating System	Warranty	Ann Date (m/y)
20DC00C0US	US	i3-5005U	No	Intel HD 5500	4GBx1	14" HD (1366x768)	None	192GB SSD	None	Intel 3160 ac, 1x1 + BT4.0	None	None	Black	PC/ABS	0.3MP	Non-backlit	None	dTPM 1.2	6-cell (47Wh)	45W	Win10 DG Win7 Pro 64	1-year, Depot	08/15



ThinkPad E460 Platform Specifications

Product Specifications Reference (PSREF)

Processor	6th Generation Intel® Core™ i3 / i5 / i7 Processor								Smart Card Reader	None	
	Processor Number	# of Cores	# of Threads	Base Frequency	Max Turbo Frequency	Cache	Memory Types	Processor Graphics	ExpressCard	None	
	i3-6100U	2	4	2.3 GHz	-	3MB	DDR3L-1600	Intel HD Graphics 520	Multicard Reader	4-in-1 reader (MMC, SD, SDHC, SDXC)	
	i5-6200U			2.3 GHz	2.8 GHz	3MB			Ports	Three USB 3.0 (one Always On), HDMI, Ethernet (RJ-45), Lenovo OneLink connector, combo audio / microphone jack	
i7-6500U	2.5 GHz			3.1 GHz	4MB	Monitor cable			None		
Graphics	Intel HD Graphics in processor only, or AMD Radeon R5 M330 Graphics, 2GB DDR3 memory, or AMD Radeon R7 M360 Graphics, 2GB DDR3 memory, digital monitor support via HDMI™ (supporting HDCP to output protected content); supports dual independent displays; Max resolution: 1920x1080 (HDMI) @60Hz								Camera	<i>Some:</i> HD720p resolution, fixed focus	
Chipset	Intel SoC (System on Chip) platform								Audio support	HD Audio, Conexant® CX11852 codec, Dolby® Advanced Audio™ / stereo speakers, 2W x 2 / dual array microphone, combo audio / microphone jack	
Memory	16GB max / PC3-12800 1600MHz DDR3L, non-parity, dual-channel capable, two 204-pin SO-DIMM sockets								Keyboard	6-row, spill-resistant, multimedia Fn keys	
Display	<i>Some:</i> 14.0" (355mm) HD (1366x768) color, anti-glare, LED backlight, 220 nits, 16:9 aspect ratio <i>Some:</i> 14.0" (355mm) FHD (1920x1080) color, anti-glare, LED backlight, IPS, 250 nits, 16:9 aspect ratio								UltraNav™	TrackPoint® pointing device and multi-touch with 3+2 buttons click pad	
Multi-touch	None								ThinkLight™	None	
Storage	<i>Some:</i> SSD / SATA 6.0Gb/s, 2.5" wide, 7mm high, removable, upgradable <i>Some:</i> HDD / SATA 6.0Gb/s, 2.5" wide, removable, upgradable, Active Protection System™ <i>Some:</i> SSHD with 8GB NAND flash memory								Security	Power-on password, hard disk password, supervisor password, security keyhole	
Optical	None								Security chip	TPM2.0 : Trusted Platform Module, TPM2.0 FW (firmware)	
M.2 SSD	None								TPM1.2 :	Trusted Platform Module, TCG 1.2-compliant	
Ethernet	Gigabit Ethernet Connection								TPM :	TPM2.0 and TPM1.2	
Bluetooth™	Bluetooth wireless, integrated in Wi-Fi + Bluetooth combo adapter								vPro	None	
WLAN	<i>One of the following, configurable by model:</i> <ul style="list-style-type: none"> Intel Dual Band Wireless-AC 3165, 1x1, Wi-Fi + BT combo adapter, M.2 Card Intel Dual Band Wireless-AC 8260, 2x2, Wi-Fi + BT combo adapter, M.2 Card BCM, Broadcom Wireless-AC, 1x1, Wi-Fi + Bluetooth combo adapter, M.2 Card QCA, Qualcomm Wireless-AC, 2x2, Wi-Fi + Bluetooth combo adapter, M.2 Card 								Fingerprint reader	<i>Some:</i> Fingerprint reader on the keyboard bezel, swipe sensor	
WWAN	None								NFC	None	
SIM card	None								Battery type	Li-Ion 6-cell (47Wh)	
Dimensions	<i>Aluminum (WxDxH):</i> 13.35" x 9.41" x 0.90"; 339mm x 239mm x 22.9mm <i>PC/ABS (WxDxH):</i> 13.35" x 9.41" x 0.96"; 339mm x 239mm x 24.4mm								Battery life	6-cell (47Wh): up to 9.0 hr	
Weight	From 4.23 lb (1.92kg)								AC adapter	<i>Some:</i> 45-watt AC adapter (Integrated Graphics) <i>Some:</i> 65-watt AC adapter (Discrete Graphics)	
Case color	Graphite black								Preload	<i>Some:</i> No operating system <i>Some:</i> Windows® 7 Professional 64 preinstalled through downgrade rights in Windows 10 Pro 64 <ul style="list-style-type: none"> Lenovo Solution Center Lenovo SHAREit ThinkVantage Product Recovery Rescue and Recovery™ ThinkVantage System Update PC Device Stage Adobe® Reader® Microsoft® Office preloaded; purchase a product key to activate McAfee® Live Safe (30-day trial) 	<i>Some:</i> Windows 10 Pro 64 <i>Some:</i> Windows 10 Home 64 <ul style="list-style-type: none"> Lenovo Solution Center Lenovo REACHit Lenovo SHAREit Lenovo Companion Lenovo Settings ThinkVantage System Update Microsoft Office preloaded; purchase a product key to activate McAfee® Live Safe (30-day trial)
Case material	<i>Aluminum:</i> Aluminum display cover <i>PC/ABS:</i> PolyCarbonate/Acrylonitrile-Butadiene-Styrene (PC/ABS) plastic display cover								Limited warranty	1-year - depot repair service / service upgrades available	
									Mil-Spec test	None	
									Environment	EPEAT™ Gold; ENERGY STAR®; RoHS-compliant	

ThinkPad E460 - TopSeller - 20ET

Product Specifications Reference (PSREF)

Model	Region	Processor	vPro	Graphics	Memory	Display	Multi-touch	Storage	Optical	WLAN + Bluetooth	WWAN	SIM Card	Color	Case Material	Camera	Keyboard	Fingerprint Reader	TPM	Battery	Power Adapter	Operating System	Warranty	Ann Date (m/y)
20ET000YUS	US	i3-6100U	No	Intel HD 520	4GBx1	14" HD (1366x768)	None	500GB 7200rpm	None	Intel 3165 ac, 1x1 + BT4.0	None	None	Black	PC/ABS	720p	Non-backlit	Fingerprint Reader	dTPM 1.2	6-cell (47Wh)	45W	Win10 DG Win7 Pro 64	1-year, Depot	11/15
20ET0010US	US	i5-6200U	No	Intel HD 520	8GBx1	14" HD (1366x768)	None	192GB SSD	None	Intel 3165 ac, 1x1 + BT4.0	None	None	Black	PC/ABS	720p	Non-backlit	Fingerprint Reader	dTPM 1.2	6-cell (47Wh)	45W	Win10 DG Win7 Pro 64	1-year, Depot	11/15
20ET0011US	US	i3-6100U	No	Intel HD 520	4GBx1	14" HD (1366x768)	None	500GB 7200rpm	None	Intel 3165 ac, 1x1 + BT4.0	None	None	Black	PC/ABS	720p	Non-backlit	Fingerprint Reader	dTPM1.2 + FW TPM2.0	6-cell (47Wh)	45W	Win10 Pro 64	1-year, Depot	11/15
20ET0012US	US	i5-6200U	No	Intel HD 520	4GBx1	14" HD (1366x768)	None	500GB 7200rpm	None	Intel 3165 ac, 1x1 + BT4.0	None	None	Black	PC/ABS	720p	Non-backlit	Fingerprint Reader	dTPM1.2 + FW TPM2.0	6-cell (47Wh)	45W	Win10 Pro 64	1-year, Depot	11/15
20ET0013US	US	i7-6500U	No	AMD R7 M360 2GB	8GBx1	14" FHD (1920x1080) IPS	None	500GB 7200rpm	None	Intel 8260 ac, 2x2 + BT4.0	None	None	Black	Aluminum	720p	Non-backlit	Fingerprint Reader	FW TPM 2.0	6-cell (47Wh)	65W	Win10 DG Win7 Pro 64	1-year, Depot	11/15
20ET0014US	US	i5-6200U	No	Intel HD 520	4GBx1	14" HD (1366x768)	None	500GB 7200rpm	None	Intel 3165 ac, 1x1 + BT4.0	None	None	Black	PC/ABS	720p	Non-backlit	Fingerprint Reader	dTPM 1.2	6-cell (47Wh)	45W	Win10 DG Win7 Pro 64	1-year, Depot	11/15
20ET0015US	US	i3-6100U	No	Intel HD 520	4GBx1	14" HD (1366x768)	None	192GB SSD	None	Intel 3165 ac, 1x1 + BT4.0	None	None	Black	PC/ABS	720p	Non-backlit	Fingerprint Reader	dTPM 1.2	6-cell (47Wh)	45W	Win10 DG Win7 Pro 64	1-year, Depot	11/15
20ET0016US	US	i5-6200U	No	Intel HD 520	8GBx1	14" HD (1366x768)	None	192GB SSD	None	Intel 3165 ac, 1x1 + BT4.0	None	None	Black	PC/ABS	720p	Non-backlit	Fingerprint Reader	dTPM1.2 + FW TPM2.0	6-cell (47Wh)	45W	Win10 Pro 64	1-year, Depot	11/15
20ET0017US	US	i5-6200U	No	Intel HD 520	4GBx1	14" HD (1366x768)	None	192GB SSD	None	Intel 3165 ac, 1x1 + BT4.0	None	None	Black	PC/ABS	720p	Non-backlit	Fingerprint Reader	dTPM1.2 + FW TPM2.0	6-cell (47Wh)	45W	Win10 Pro 64	1-year, Depot	11/15
20ET0018US	US	i3-6100U	No	Intel HD 520	4GBx1	14" HD (1366x768)	None	192GB SSD	None	Intel 3165 ac, 1x1 + BT4.0	None	None	Black	PC/ABS	720p	Non-backlit	Fingerprint Reader	dTPM1.2 + FW TPM2.0	6-cell (47Wh)	45W	Win10 Pro 64	1-year, Depot	11/15
20ET0019US	US	i7-6500U	No	AMD R7 M360 2GB	8GBx1	14" FHD (1920x1080) IPS	None	192GB SSD	None	Intel 8260 ac, 2x2 + BT4.0	None	None	Black	Aluminum	720p	Non-backlit	Fingerprint Reader	FW TPM 2.0	6-cell (47Wh)	65W	Win10 DG Win7 Pro 64	1-year, Depot	11/15
20ET001AUS	US	i5-6200U	No	Intel HD 520	4GBx1	14" HD (1366x768)	None	192GB SSD	None	Intel 3165 ac, 1x1 + BT4.0	None	None	Black	PC/ABS	720p	Non-backlit	Fingerprint Reader	dTPM 1.2	6-cell (47Wh)	45W	Win10 DG Win7 Pro 64	1-year, Depot	11/15
20ET001BUS	US	i7-6500U	No	AMD R7 M360 2GB	8GBx1	14" FHD (1920x1080) IPS	None	192GB SSD	None	Intel 8260 ac, 2x2 + BT4.0	None	None	Black	Aluminum	720p	Non-backlit	Fingerprint Reader	FW TPM 2.0	6-cell (47Wh)	65W	Win10 Pro 64	1-year, Depot	11/15
20ET001CUS	US	i7-6500U	No	AMD R7 M360 2GB	8GBx1	14" FHD (1920x1080) IPS	None	500GB 7200rpm	None	Intel 8260 ac, 2x2 + BT4.0	None	None	Black	Aluminum	720p	Non-backlit	Fingerprint Reader	FW TPM 2.0	6-cell (47Wh)	65W	Win10 Pro 64	1-year, Depot	11/15
20ET004GUS	US	i7-6500U	No	AMD R7 M360 2GB	8GBx1	14" FHD (1920x1080) IPS	None	256GB SSD Opal2	None	Intel 8260 ac, 2x2 + BT4.0	None	None	Black	Aluminum	720p	Non-backlit	Fingerprint Reader	FW TPM 2.0	6-cell (47Wh)	65W	Win10 Pro 64	1-year, Depot	04/16
20ET004HUS	US	i7-6500U	No	AMD R7 M360 2GB	8GBx1	14" FHD (1920x1080) IPS	None	256GB SSD Opal2	None	Intel 8260 ac, 2x2 + BT4.0	None	None	Black	Aluminum	720p	Non-backlit	Fingerprint Reader	FW TPM 2.0	6-cell (47Wh)	65W	Win10 DG Win7 Pro 64	1-year, Depot	04/16
20ET004VUS	US	i5-6200U	No	Intel HD 520	4GBx1	14" HD (1366x768)	None	256GB SSD Opal2	None	Intel 8260 ac, 2x2 + BT4.0	None	None	Black	PC/ABS	720p	Non-backlit	Fingerprint Reader	dTPM 1.2	6-cell (47Wh)	45W	Win10 DG Win7 Pro 64	1-year, Depot	09/16
20ET004WUS	US	i5-6200U	No	Intel HD 520	8GBx1	14" FHD (1920x1080) IPS	None	256GB SSD Opal2	None	Intel 8260 ac, 2x2 + BT4.0	None	None	Black	Aluminum	720p	Non-backlit	Fingerprint Reader	dTPM 1.2	6-cell (47Wh)	45W	Win10 DG Win7 Pro 64	1-year, Depot	09/16
20ET0054US	US	i5-6200U	No	Intel HD 520	8GBx1	14" HD (1366x768)	None	500GB 7200rpm	None	Intel 3165 ac, 1x1 + BT4.0	None	None	Black	PC/ABS	720p	Non-backlit	Fingerprint Reader	dTPM1.2 + FW TPM2.0	6-cell (47Wh)	45W	Win10 Pro 64	1-year, Depot	10/16
20ET0055US	US	i5-6200U	No	Intel HD 520	8GBx1	14" FHD (1920x1080) IPS	None	500GB 7200rpm	None	Intel 3165 ac, 1x1 + BT4.0	None	None	Black	Aluminum	720p	Non-backlit	Fingerprint Reader	dTPM1.2 + FW TPM2.0	6-cell (47Wh)	45W	Win10 Pro 64	1-year, Depot	10/16



ThinkPad E465 Platform Specifications

Product Specifications Reference (PSREF)

Processor	AMD Accelerated Processor A6, A8, or A10 APU								Smart Card Reader	None
	Processor Number	# of Cores	# of Threads	Clock Speed	Max Turbo Frequency	Cache	Memory speed	Graphics	ExpressCard	None
	A6-8500P	2	6	1.6 GHz	3.0 GHz	1MB	DDR3L-1600	R5 Graphics	Multicard Reader	4-in-1 reader (MMC, SD, SDHC, SDXC)
	A6-8500P	2	6	1.6 GHz	3.0 GHz	1MB		R5 M330	Ports	Three USB 3.0 (one Always On), HDMI, Ethernet (RJ-45), Lenovo OneLink connector, combo audio / microphone jack
	A8-8600P	4	10	1.6 GHz	3.0 GHz	2MB		R6 M335DX (R6+R5 M330)	Monitor cable	None
A10-8700P	4	10	1.8 GHz	3.2 GHz	2MB	R6 M340DX (R6+R5 M330)		Camera	HD720p resolution, fixed focus	
Graphics	AMD Radeon™ R5 Graphics in processor only, or AMD Radeon R5 M330 Graphics, 2GB DDR3 memory, or Dual Graphics support for A8 and A10 APU digital monitor support via HDMI™ (supporting HDCP to output protected content); supports dual independent display Max resolution: 1920x1080 (HDMI) @60Hz								Keyboard	6-row, spill-resistant, multimedia Fn keys
	Chipset	AMD SoC (System on Chip) platform								UltraNav™
Memory	16GB max / PC3-12800 1600MHz DDR3L, non-parity, dual-channel capable, two 204-pin SO-DIMM sockets								ThinkLight™	None
Display	<i>Some:</i> 14.0" (355mm) HD (1366x768) color, anti-glare, LED backlight, 220 nits, 16:9 aspect ratio <i>Some:</i> 14.0" (355mm) FHD (1920x1080) color, anti-glare, LED backlight, IPS, 250 nits, 16:9 aspect ratio								Security	Power-on password, hard disk password, supervisor password, security keyhole
Multi-touch	None								Security chip	<i>TPM2.0:</i> Trusted Platform Module, TPM2.0 FW (firmware) <i>TPM1.2:</i> Trusted Platform Module, TCG 1.2-compliant <i>TPM:</i> TPM2.0 and TPM1.2
Storage	<i>Some:</i> SSD / SATA 6.0Gb/s, 2.5" wide, 7mm high, removable, upgradable <i>Some:</i> HDD / SATA 6.0Gb/s, 2.5" wide, removable, upgradable, Active Protection System™ <i>Some:</i> SSHD with 8GB NAND flash memory								vPro	None
Optical	None								Fingerprint reader	<i>Some:</i> Fingerprint reader on the keyboard bezel, swipe sensor
M.2 SSD	None								NFC	None
Ethernet	Gigabit Ethernet Connection								Battery type	Li-Ion 6-cell (47Wh)
Bluetooth™	Bluetooth wireless, integrated in Wi-Fi + Bluetooth combo adapter								Battery life	Up to 6.5 hr
WLAN	<i>One of the following, configurable by model:</i> <ul style="list-style-type: none"> • BCM, Broadcom Wireless-AC, 1x1, Wi-Fi + Bluetooth combo adapter, M.2 Card • QCA, Qualcomm Wireless-AC, 2x2, Wi-Fi + Bluetooth combo adapter, M.2 Card 								AC adapter	<i>Some:</i> 45-watt AC adapter (Integrated Graphics) <i>Some:</i> 65-watt AC adapter (Discrete Graphics)
WWAN	None								Preload	<i>Some:</i> No operating system <i>Some:</i> Windows® 7 Professional 64 <i>Some:</i> Windows® 7 Professional 64 preinstalled through downgrade rights in Windows 10 Pro 64 <ul style="list-style-type: none"> • Lenovo Solution Center • Lenovo SHAREit • ThinkVantage Product Recovery • Rescue and Recovery™ • ThinkVantage System Update • PC Device Stage • Adobe® Reader® • Microsoft® Office preloaded; • Microsoft® Office preloaded; purchase a product key to activate • McAfee® Live Safe (30-day trial)
SIM card	None								Limited warranty	1-year - depot repair service / service upgrades available
Dimensions	<i>Aluminum (WxDxH):</i> 13.35" x 9.41" x 0.90"; 339mm x 239mm x 22.9mm <i>PC/ABS (WxDxH):</i> 13.35" x 9.41" x 0.96"; 339mm x 239mm x 24.4mm								Environment	EPEAT™ Gold; ENERGY STAR®; RoHS-compliant
Weight	From 4.27 lb (1.94kg)									
Case color	Graphite black									
Case material	<i>Aluminum:</i> Aluminum display cover <i>PC/ABS:</i> PolyCarbonate/Acrylonitrile-Butadiene-Styrene (PC/ABS) plastic display cover									

ThinkPad E465 - TopSeller - 20EX

Product Specifications Reference (PSREF)

Model	Region	Processor	vPro	Graphics	Memory	Display	Multi-touch	Storage	Optical	WLAN + Bluetooth	WWAN	SIM Card	Color	Case Material	Camera	Keyboard	Fingerprint Reader	TPM	Battery	Power Adapter	Operating System	Warranty	Ann Date (m/y)
20EX0008US	US	AMD A10-8700P	No	AMD R6 M340DX 2GB	4GBx1	14" HD (1366x768)	None	500GB 5400rpm	None	BCM43162 ac, 1x1 + BT4.0	None	None	Black	PC/ABS	720p	Non-backlit	None	FW TPM 2.0	6-cell (47Wh)	65W	Win10 DG Win7 Pro 64	1-year, Depot	11/15
20EX0009US	US	AMD A10-8700P	No	AMD R6 M340DX 2GB	8GBx1	14" HD (1366x768)	None	192GB SSD	None	BCM43162 ac, 1x1 + BT4.0	None	None	Black	PC/ABS	720p	Non-backlit	None	FW TPM 2.0	6-cell (47Wh)	65W	Win10 Pro 64	1-year, Depot	11/15
20EX000AUS	US	AMD A10-8700P	No	AMD R6 M340DX 2GB	4GBx1	14" HD (1366x768)	None	500GB 5400rpm	None	BCM43162 ac, 1x1 + BT4.0	None	None	Black	PC/ABS	720p	Non-backlit	None	FW TPM 2.0	6-cell (47Wh)	65W	Win10 Pro 64	1-year, Depot	11/15
20EX000BUS	US	AMD A10-8700P	No	AMD R6 M340DX 2GB	8GBx1	14" HD (1366x768)	None	500GB 5400rpm	None	BCM43162 ac, 1x1 + BT4.0	None	None	Black	PC/ABS	720p	Non-backlit	None	FW TPM 2.0	6-cell (47Wh)	65W	Win10 DG Win7 Pro 64	1-year, Depot	11/15
20EX000CUS	US	AMD A6-8500P	No	AMD R5 Graphics	4GBx1	14" HD (1366x768)	None	500GB 5400rpm	None	BCM43162 ac, 1x1 + BT4.0	None	None	Black	PC/ABS	720p	Non-backlit	None	dTPM 1.2	6-cell (47Wh)	45W	Win10 DG Win7 Pro 64	1-year, Depot	11/15
20EX000DUS	US	AMD A10-8700P	No	AMD R6 M340DX 2GB	8GBx1	14" HD (1366x768)	None	500GB 5400rpm	None	BCM43162 ac, 1x1 + BT4.0	None	None	Black	PC/ABS	720p	Non-backlit	None	FW TPM 2.0	6-cell (47Wh)	65W	Win10 Pro 64	1-year, Depot	11/15
20EX000EUS	US	AMD A10-8700P	No	AMD R6 M340DX 2GB	8GBx1	14" HD (1366x768)	None	192GB SSD	None	BCM43162 ac, 1x1 + BT4.0	None	None	Black	PC/ABS	720p	Non-backlit	None	FW TPM 2.0	6-cell (47Wh)	65W	Win10 DG Win7 Pro 64	1-year, Depot	11/15
20EX001JUS	US	AMD A10-8700P	No	AMD R6 M340DX 2GB	4GBx1	14" FHD (1920x1080) IPS	None	500GB 5400rpm	None	QCA435 ac, 1x1 + BT4.0	None	None	Black	Aluminum	720p	Non-backlit	None	FW TPM 2.0	6-cell (47Wh)	65W	Win10 Pro 64	1-year, Depot	06/16
20EX001KUS	US	AMD A10-8700P	No	AMD R6 M340DX 2GB	8GBx1	14" FHD (1920x1080) IPS	None	192GB SSD	None	QCA435 ac, 1x1 + BT4.0	None	None	Black	Aluminum	720p	Non-backlit	None	FW TPM 2.0	6-cell (47Wh)	65W	Win10 Pro 64	1-year, Depot	06/16
20EX001LUS	US	AMD A6-8500P	No	AMD R5 Graphics	4GBx1	14" HD (1366x768)	None	500GB 5400rpm	None	QCA435 ac, 1x1 + BT4.0	None	None	Black	PC/ABS	720p	Non-backlit	None	dTPM 1.2	6-cell (47Wh)	45W	Win10 DG Win7 Pro 64	1-year, Depot	06/16
20EX001MUS	US	AMD A10-8700P	No	AMD R6 M340DX 2GB	8GBx1	14" HD (1366x768)	None	192GB SSD	None	QCA435 ac, 1x1 + BT4.0	None	None	Black	PC/ABS	720p	Non-backlit	None	FW TPM 2.0	6-cell (47Wh)	65W	Win10 DG Win7 Pro 64	1-year, Depot	06/16
20EX001NUS	US	AMD A6-8500P	No	AMD R5 Graphics	4GBx1	14" HD (1366x768)	None	500GB 5400rpm	None	QCA435 ac, 1x1 + BT4.0	None	None	Black	PC/ABS	720p	Non-backlit	None	dTPM1.2 + FW TPM2.0	6-cell (47Wh)	45W	Win10 Pro 64	1-year, Depot	06/16
20EX001PUS	US	AMD A10-8700P	No	AMD R6 M340DX 2GB	8GBx1	14" HD (1366x768)	None	500GB 5400rpm	None	QCA435 ac, 1x1 + BT4.0	None	None	Black	PC/ABS	720p	Non-backlit	None	FW TPM 2.0	6-cell (47Wh)	65W	Win10 DG Win7 Pro 64	1-year, Depot	06/16
20EX001QUS	US	AMD A10-8700P	No	AMD R6 M340DX 2GB	8GBx1	14" FHD (1920x1080) IPS	None	500GB 5400rpm	None	QCA435 ac, 1x1 + BT4.0	None	None	Black	Aluminum	720p	Non-backlit	None	FW TPM 2.0	6-cell (47Wh)	65W	Win10 Pro 64	1-year, Depot	06/16
20EX001RUS	US	AMD A10-8700P	No	AMD R6 M340DX 2GB	4GBx1	14" HD (1366x768)	None	500GB 5400rpm	None	QCA435 ac, 1x1 + BT4.0	None	None	Black	PC/ABS	720p	Non-backlit	None	FW TPM 2.0	6-cell (47Wh)	65W	Win10 DG Win7 Pro 64	1-year, Depot	06/16

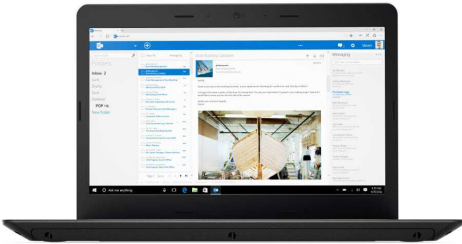

ThinkPad E470 Platform Specifications

Product Specifications Reference (PSREF)

Processor	6th or 7th Generation Intel® Core™ i3 / i5 / i7 Processor								Dimensions	<i>Aluminum (WxDxH):</i> 13.35" x 9.53" x 0.88"; 339mm x 242mm x 22.4mm <i>PC/ABS (WxDxH):</i> 13.35" x 9.53" x 0.93"; 339mm x 242mm x 23.7mm	
	Processor Number	# of Cores	# of Threads	Base Frequency	Max Turbo Frequency	Cache	Memory Types	Processor Graphics	Weight	From 4.12 lb (1.87kg)	
	i3-7100U	2	4	2.4 GHz	-	3MB	DDR4-2133	Intel HD Graphics 620	Case color	Black, Silver, Gold	
	i5-7200U			2.5 GHz	3.1 GHz	3MB			Case material	<i>Aluminum:</i> Aluminum display cover <i>PC/ABS:</i> PolyCarbonate/Acrylonitrile-Butadiene-Styrene display cover	
	i7-7500U			2.7 GHz	3.5 GHz	4MB			Camera	<i>Some:</i> HD720p resolution, fixed focus	
i3-6006U	2	4	2.0 GHz	-	3MB	DDR4-2133	Intel HD Graphics 520	Audio support	HD Audio, Conexant® CX11852 codec, Dolby® Audio™ Premium / stereo speakers, 2W x 2 / dual array microphone, combo audio / microphone jack		
Graphics	Intel HD Graphics in processor only, or NVIDIA GeForce 920MX Graphics, 2GB DDR3 memory, or NVIDIA GeForce 940MX Graphics, 2GB DDR3 memory, digital monitor support via HDMI™ (supporting HDCP to output protected content); supports dual independent displays; Max resolution: 1920x1080 (HDMI)@60Hz								Keyboard	6-row, spill-resistant, multimedia Fn keys	
Chipset	Intel SoC (System on Chip) platform 32GB max / PC4-19200 2400MHz DDR4, non-parity, dual-channel capable, two 260-pin SO-DIMM sockets *System automatically clocks down with 1866MHz DDR4 memory controller								UltraNav™	TrackPoint® pointing device and multi-touch with 3+2 buttons click pad	
Memory									ThinkLight™	None	
Display	Some: 14.0" (355mm) HD (1366x768), anti-glare, LED backlight, 220 nits, 16:9 aspect ratio, 400:1 contrast ratio Some: 14.0" (355mm) FHD (1920x1080), anti-glare, LED backlight, IPS, 250 nits, 16:9 aspect ratio, 400:1 contrast ratio								Fingerprint reader	<i>Some:</i> Fingerprint reader on the keyboard bezel, swipe sensor	
Multi-touch	None								NFC	None	
Storage	<i>Some:</i> SSD / SATA 6.0Gb/s, 2.5" wide, 7mm high, removable, upgradable <i>Some:</i> HDD / SATA 6.0Gb/s, 2.5" wide, removable, upgradable, Active Protection System™								Security	Power-on password, hard disk password, supervisor password, security keyhole	
M.2 SSD	None								Security chip	<i>FW TPM 2.0:</i> Firmware TPM 2.0, integrated in chipset <i>dTPM 2.0:</i> Discrete TPM 2.0, TCG Certified	
Optical	None								vPro	No	
Ethernet	Gigabit Ethernet Connection, Realtek R8111GUS								Battery type	Li-Polymer 3-cell (45Wh)	
WLAN	<i>One of the following, configurable by model:</i> • Intel Dual Band Wireless-AC 8265, 2x2, Wi-Fi + BT combo adapter, M.2 Card • QCA, Qualcomm 344A-AC, 2x2, Wi-Fi + Bluetooth combo adapter, M.2 Card • QCA, Qualcomm 435-AC, 1x1, Wi-Fi + Bluetooth combo adapter, M.2 Card								Battery life	3-cell (45Wh): up to 8.4 hr <i>Some:</i> 45-watt AC adapter <i>Some:</i> 65-watt AC adapter <i>Some:</i> 90-watt AC adapter	
Bluetooth™	Bluetooth wireless, integrated in Wi-Fi + Bluetooth combo adapter								AC adapter		
WWAN	None								Preload	<i>Some:</i> Windows 10 Pro 64 <i>Some:</i> Windows 10 Home 64 • Lenovo Companion • Lenovo Settings • Microsoft Office preloaded; purchase a product key to activate • McAfee® Live Safe (30-day trial)	
SIM card	None								Limited warranty	1-year - depot repair service / service upgrades available	
Smart Card Reader	None								Mil-Spec test	None	
ExpressCard	None								Environment	EPEAT™ Gold; ENERGY STAR®; RoHS-compliant	
Dock	None										
Multicard Reader	4-in-1 reader (MMC, SD, SDHC, SDXC)										
Ports	Two USB 3.0 (one Always On), one USB 2.0, HDMI, Ethernet (RJ-45), combo audio / microphone jack										
Monitor cable	None										

ThinkPad E470 - TopSeller - 20H1

Product Specifications Reference (PSREF)

Model	Region	Processor	vPro	Graphics	Memory	Display	Multi-touch	Storage	Optical	WLAN + Bluetooth	WWAN	SIM Card	Color	Case Material	Camera	Keyboard	Fingerprint Reader	TPM	Battery	Power Adapter	Operating System	Warranty	Ann Date (m/y)
20H10038US	US	i3-7100U	No	Intel HD 620	4GBx1	14" HD (1366x768)	None	500GB 7200rpm	None	11ac, 1x1 + BT4.1	None	None	Black	PC/ABS	720p	Non-backlit	Fingerprint Reader	dTPM 2.0	6-cell (45Wh)	45W	Windows 10 Pro 64	1-year, Depot	09/16
20H10039US	US	i5-7200U	No	Intel HD 620	4GBx1	14" HD (1366x768)	None	500GB 7200rpm	None	11ac, 1x1 + BT4.1	None	None	Black	PC/ABS	720p	Non-backlit	Fingerprint Reader	dTPM 2.0	6-cell (45Wh)	45W	Windows 10 Pro 64	1-year, Depot	09/16
20H1003AUS	US	i5-7200U	No	Intel HD 620	8GBx1	14" HD (1366x768)	None	256GB SSD Opal2	None	11ac, 1x1 + BT4.1	None	None	Black	PC/ABS	720p	Non-backlit	Fingerprint Reader	dTPM 2.0	6-cell (45Wh)	45W	Windows 10 Pro 64	1-year, Depot	09/16
20H1003DUS	US	i3-6006U	No	Intel HD 520	4GBx1	14" HD (1366x768)	None	500GB 7200rpm	None	11ac, 1x1 + BT4.1	None	None	Black	PC/ABS	720p	Non-backlit	Fingerprint Reader	dTPM 2.0	3-cell (45Wh)	45W	Windows 10 Pro 64	1-year, Depot	11/16
20H1004RUS	US	i7-7500U	No	940MX 2GB	8GBx1	14" FHD (1920x1080) IPS	None	500GB 7200rpm	None	Intel 8265 ac, 2x2 + BT4.1	None	None	Black	PC/ABS	720p	Non-backlit	Fingerprint Reader	FW TPM 2.0	6-cell (45Wh)	65W	Windows 10 Pro 64	1-year, Depot	09/16
20H1004SUS	US	i5-7200U	No	Intel HD 620	8GBx1	14" FHD (1920x1080) IPS	None	256GB SSD Opal2	None	11ac, 1x1 + BT4.1	None	None	Black	PC/ABS	720p	Non-backlit	Fingerprint Reader	dTPM 2.0	6-cell (45Wh)	45W	Windows 10 Pro 64	1-year, Depot	09/16
20H1004TUS	US	i7-7500U	No	940MX 2GB	8GBx1	14" FHD (1920x1080) IPS	None	256GB SSD Opal2	None	Intel 8265 ac, 2x2 + BT4.1	None	None	Black	PC/ABS	720p	Non-backlit	Fingerprint Reader	FW TPM 2.0	6-cell (45Wh)	65W	Windows 10 Pro 64	1-year, Depot	09/16
20H10059US	US	i3-7100U	No	Intel HD 620	4GBx1	14" HD (1366x768)	None	180GB SSD Opal2	None	11ac, 1x1 + BT4.1	None	None	Black	PC/ABS	720p	Non-backlit	Fingerprint Reader	dTPM 2.0	3-cell (45Wh)	45W	Windows 10 Pro 64	1-year, Depot	01/17
20H1005AUS	US	i5-7200U	No	Intel HD 620	4GBx1	14" HD (1366x768)	None	180GB SSD Opal2	None	11ac, 1x1 + BT4.1	None	None	Black	PC/ABS	720p	Non-backlit	Fingerprint Reader	dTPM 2.0	3-cell (45Wh)	45W	Windows 10 Pro 64	1-year, Depot	01/17
20H1005BUS	US	i5-7200U	No	Intel HD 620	8GBx1	14" HD (1366x768)	None	180GB SSD Opal2	None	11ac, 1x1 + BT4.1	None	None	Black	PC/ABS	720p	Non-backlit	Fingerprint Reader	dTPM 2.0	3-cell (45Wh)	45W	Windows 10 Pro 64	1-year, Depot	01/17

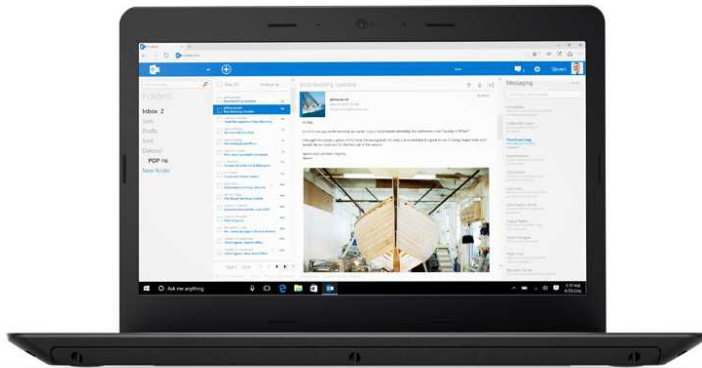

ThinkPad E475 Platform Specifications

Product Specifications Reference (PSREF)

Processor	AMD Accelerated Processor A6, or A10 APU								Dimensions Weight	PC/ABS (WxDxH): 13.35" x 9.53" x 0.93"; 339mm x 242mm x 23.7mm	
	Processor Number	# of Cores	# of Threads	Base Frequency	Max Turbo Frequency	Cache	Memory Types	Processor Graphics		Case color	From 4.12 lb (1.87kg)
	A6-9500B	2	4	2.3 GHz	3.2 GHz	2MB	DDR4-1866	R5 Graphics		Case material	Black
A10-9600P	4	8	2.4 GHz	3.3 GHz	2MB	PC/ABS: PolyCarbonate/Acrylonitrile-Butadiene-Styrene display cover					
Graphics	AMD Radeon™ R5 Graphics in processor only, or AMD Radeon R5 M430 Graphics, 2GB DDR3 memory, or digital monitor support via HDMI™ (supporting HDCP to output protected content); supports dual independent displays; Max resolution: 1920x1080 (HDMI)@60Hz								Camera	HD720p resolution, fixed focus	
									Audio support	HD Audio, Conexant® CX11852 codec, Dolby® Audio™ Premium / stereo speakers, 2W x 2 / dual array microphone, combo audio / microphone jack	
Chipset	AMD SoC (System on Chip) platform								Keyboard	6-row, spill-resistant, multimedia Fn keys	
									Memory	32GB max / PC4-19200 2400MHz DDR4, non-parity, dual-channel capable, two 260-pin SO-DIMM sockets *System automatically clocks down with 1866MHz DDR4 memory controller	
Display	Some: 14.0" (355mm) HD (1366x768), anti-glare, LED backlight, 220 nits, 16:9 aspect ratio, 400:1 contrast ratio								ThinkLight™	None	
Multi-touch	None								Fingerprint reader	None	
Storage	Some: SSD / SATA 6.0Gb/s, 2.5" wide, 7mm high, removable, upgradable Some: HDD / SATA 6.0Gb/s, 2.5" wide, removable, upgradable, Active Protection System™								NFC	None	
M.2 SSD	None								Security	Power-on password, hard disk password, supervisor password, security keyhole	
Optical	None								Security chip	FW TPM2.0: Firmware TPM 2.0, integrated in chipset dTPM2.0: Discrete TPM 2.0, TCG Certified	
Ethernet	Gigabit Ethernet Connection, Realtek R8111GUS								vPro	No	
WLAN	One of the following, configurable by model: • QCA, Qualcomm 344A-AC, 2x2, Wi-Fi + Bluetooth combo adapter, M.2 Card • QCA, Qualcomm 435-AC, 1x1, Wi-Fi + Bluetooth combo adapter, M.2 Card Bluetooth wireless, integrated in Wi-Fi + Bluetooth combo adapter								Battery type	Li-Polymer 3-cell (45Wh)	
Bluetooth™	None								Battery life	3-cell (45Wh): up to 6.5 hr	
WWAN	None								AC adapter	Some: 45-watt AC adapter Some: 65-watt AC adapter	
SIM card	None								Preload	Some: Windows 10 Pro 64 Some: Windows 10 Home 64 • Lenovo Companion • Lenovo Settings • Microsoft Office preloaded; purchase a product key to activate • McAfee® Live Safe (30-day trial)	
Smart Card Reader	None								Limited warranty	1-year - depot repair service / service upgrades available	
ExpressCard	None								Mil-Spec test	None	
Dock	None								Environment	EPEAT™ Gold; ENERGY STAR®; RoHS-compliant	
Multicard Reader	4-in-1 reader (MMC, SD, SDHC, SDXC)										
Ports	Two USB 3.0 (one Always On), one USB 2.0, HDMI, Ethernet (RJ-45), combo audio / microphone jack										
Monitor cable	None										

ThinkPad E475 - TopSeller - 20H4

Product Specifications Reference (PSREF)

Model	Region	Processor	vPro	Graphics	Memory	Display	Multi-touch	Storage(HDD/SSD)	Optical	WLAN + Bluetooth	WWAN	SIM Card	Color	Case Material	Camera	Keyboard	Fingerprint Reader	TPM	Battery	Power Adapter	Operating System	Warranty	Ann Date (m/y)
20H40006US	US	AMD A6-9500B	No	AMD R5 Graphics	4GBx1	14" HD (1366x768)	None	500GB 7200rpm	None	QCA435ac, 1x1 + BT4.1	None	None	Black	PC/ABS	720p	Non-backlit	None	dTPM 2.0	3-cell (45Wh)	45W	Windows 10 Pro 64	1-year, Depot	11/16
20H40007US	US	AMD A10-9600P	No	AMD R5 M430 2GB	8GBx1	14" HD (1366x768)	None	500GB 7200rpm	None	QCA435ac, 1x1 + BT4.1	None	None	Black	PC/ABS	720p	Non-backlit	None	FW TPM 2.0	3-cell (45Wh)	65W	Windows 10 Pro 64	1-year, Depot	11/16
20H40008US	US	AMD A10-9600P	No	AMD R5 M430 2GB	4GBx1	14" HD (1366x768)	None	500GB 7200rpm	None	QCA435ac, 1x1 + BT4.1	None	None	Black	PC/ABS	720p	Non-backlit	None	FW TPM 2.0	3-cell (45Wh)	65W	Windows 10 Pro 64	1-year, Depot	11/16
20H40009US	US	AMD A6-9500B	No	AMD R5 Graphics	8GBx1	14" HD (1366x768)	None	500GB 7200rpm	None	QCA435ac, 1x1 + BT4.1	None	None	Black	PC/ABS	720p	Non-backlit	None	dTPM 2.0	3-cell (45Wh)	45W	Windows 10 Pro 64	1-year, Depot	11/16
20H4000AUS	US	AMD A10-9600P	No	AMD R5 M430 2GB	8GBx1	14" HD (1366x768)	None	256GB SSD Opal2	None	QCA435ac, 1x1 + BT4.1	None	None	Black	PC/ABS	720p	Non-backlit	None	FW TPM 2.0	3-cell (45Wh)	65W	Windows 10 Pro 64	1-year, Depot	11/16
20H4000DUS	US	AMD A10-9600P	No	AMD R5 M430 2GB	8GBx1	14" HD (1366x768)	None	180GB SSD Opal2	None	QCA435ac, 1x1 + BT4.1	None	None	Black	PC/ABS	720p	Non-backlit	None	FW TPM 2.0	3-cell (45Wh)	65W	Windows 10 Pro 64	1-year, Depot	01/17



ThinkPad E550 Platform Specifications

Product Specifications Reference (PSREF)

Processor	4th or 5th Generation Intel® Core™ i3 / i5 / i7 Processor								Multicard Reader Ports Monitor cable Camera Audio support	4-in-1 reader (MMC, SD, SDHC, SDXC) Two USB 3.0 (one Always On), one USB 2.0, Ethernet (RJ-45), external monitor (VGA DB-15, HDMI), Lenovo OneLink connector None <i>Some:</i> 0.3-megapixel, fixed focus <i>Some:</i> HD720p resolution, fixed focus <i>Some:</i> 3D camera, Intel RealSense™ 3D Camera with MIC HD Audio, Conexant® CX20751 codec, Dolby® Advanced Audio™ v4 / stereo speakers or JBL speakers, 2W x 2 / dual array microphone, combo audio / microphone jack
	Processor Number	# of Cores	# of Threads	Base Frequency	Max Turbo Frequency	Cache	Memory speed	Processor Graphics		
	i3-4005U	2	4	1.7 GHz	-	3MB	DDR3L-1600	HD4400		
	i3-5005U	2	4	2.0 GHz	-	3MB		HD5500		
	i3-5015U	2	4	2.1 GHz		3MB		HD5500		
	i5-5200U	2	4	2.2 GHz	2.7 GHz	3MB		HD5500		
i7-5500U	2	4	2.4 GHz	3.0 GHz	4MB	HD5500				
Graphics	Intel HD Graphics in processor only, or AMD Radeon R7 M260 Graphics, 2GB DDR3 memory, external analog monitor support via VGA DB-15 connector and digital monitor support via HDMI™ (supporting HDCP to output protected content); supports dual independent display Max resolution: 1920x1080 (HDMI)@60Hz								Keyboard UltraNav™ ThinkLight™	6-row, spill-resistant, multimedia Fn keys, numeric keypad TrackPoint® pointing device and multi-touch with 3+2 buttons click pad None
Chipset Memory	Intel SoC (System on Chip) platform 16GB max ⁷ / PC3-12800 1600MHz DDR3L, non-parity, dual-channel capable, two 204-pin SO-DIMM sockets								Security Security chip vPro Fingerprint reader NFC	Power-on password, hard disk password, supervisor password, security keyhole <i>Some:</i> Trusted Platform Module, TCG 1.2-compliant None <i>Some:</i> Fingerprint reader on the keyboard bezel, swipe sensor None
Display	<i>Some:</i> 15.6" (396mm) HD (1366x768) color, anti-glare, LED backlight, 200 nits, 16:9 aspect ratio <i>Some:</i> 15.6" (396mm) FHD (1920x1080) color, anti-glare, LED backlight, 220 nits, 16:9 aspect ratio								Battery type Battery life AC adapter	Li-Ion 6-cell (48Wh) 6-cell (48Wh): up to 9.0 hr <i>Some:</i> 45-watt AC adapter (Integrated Graphics) <i>Some:</i> 65-watt AC adapter (Discrete Graphics)
Multi-touch	<i>Some:</i> supports 10-finger gesture								Preload	<i>Some:</i> No operating system <i>Some:</i> Windows® 7 Professional 64 preinstalled through downgrade rights in Windows 8.1 Pro 64-bit • Lenovo Solution Center • Lenovo SHAREit • ThinkVantage Product Recovery • Rescue and Recovery™ • ThinkVantage System Update • Microsoft® Office preloaded; purchase a product key to activate • Norton™ Internet Security (30 days of virus definitions) <i>Some:</i> Windows 7 Professional preinstalled through downgrade rights in Windows 10 Pro 64 • Lenovo Solution Center • Lenovo SHAREit • ThinkVantage Product Recovery • Rescue and Recovery™ <i>Some:</i> Windows 10 Pro 64 <i>Some:</i> Windows 10 Home 64 • Lenovo Solution Center • Lenovo SHAREit • Lenovo Companion • Microsoft Office preloaded; purchase a product key to activate • McAfee LiveSafe (30 days of virus definitions)
Storage	<i>Some:</i> SSD / SATA 6.0Gb/s, 2.5" wide, 7mm high, removable, upgradable <i>Some:</i> HDD / SATA 6.0Gb/s, 2.5" wide, removable, upgradable, Shock Mounted Hard Drive, Active Protection System™ <i>Some:</i> Hybrid drive with 8GB NAND flash memory <i>Some:</i> DVD burner, 9.0mm high, removable <i>Some:</i> Blank Bezel None									
Optical										
M.2 SSD										
Ethernet	Intel WGI218V Gigabit Ethernet Connection									
Bluetooth™	Bluetooth 4.0 wireless, integrated in Wi-Fi + Bluetooth combo adapter									
WLAN	<i>One of the following, configurable by model:</i> • Intel Wireless-AC 3160, 1x1, Wi-Fi + Bluetooth combo adapter, M.2 Card • Intel Dual Band Wireless-AC 7265, 2x2, Wi-Fi + BT combo adapter, M.2 Card • RTL8723BE, Realtek 11b/g/n, 1x1, Wi-Fi + Bluetooth combo adapter, M.2 Card • BCM43162, Broadcom 11-AC, 1x1, Wi-Fi + BT combo adapter, M.2 Card									
WWAN	None									
SIM card	None									
Smart Card Read ExpressCard	None									
Dimensions	<i>None Touch(WxDxH):</i> 14.84" x 10.08" x 1.06"; 377mm x 256mm x 27mm									
Weight	<i>6-cell None Touch:</i> from 5.21 lb (2.35kg)									
Case color	Graphite Black									
Case material	PolyCarbonate/Acrylonitrile-Butadiene-Styrene (PC/ABS) plastic									
Limited warranty	1-year - depot repair service / service upgrades available									
Environment	EPEAT™ Gold; ENERGY STAR®; RoHS-compliant									

Model	Region	Processor	vPro	Graphics	Memory	Display	Multi-touch	Storage(HDD/SSD)	Optical	WLAN + Bluetooth	WWAN	SIM Card	Color	Case Material	Camera	Keyboard	Fingerprint Reader	TPM	Battery	Power Adapter	Operating System	Warranty	Ann Date (m/y)
20DF002WUS	US	i3-5005U	No	Intel HD 5500	4GBx1	15.6" HD (1366x768)	None	500GB 7200rpm	DVD±RW	Intel 3160 ac, 1x1 + BT4.0	None	None	Black	PC/ABS	720p	Non-backlit	Fingerprint Reader	dTPM 1.2	6-cell (48Wh)	45W	Win8.1 64-bit	1-year, Depot	01/15
20DF002XUS	US	i7-5500U	No	AMD R7 M260 2GB	8GBx1	15.6" HD (1366x768)	None	128GB SSD	DVD±RW	Intel 7265 ac, 2x2 + BT4.0	None	None	Black	PC/ABS	720p	Non-backlit	Fingerprint Reader	None	6-cell (48Wh)	65W	Win8.1 Pro 64-bit	1-year, Depot	01/15
20DF002YUS	US	i3-4005U	No	Intel HD 4400	4GBx1	15.6" HD (1366x768)	None	500GB 7200rpm	DVD±RW	Intel 3160 ac, 1x1 + BT4.0	None	None	Black	PC/ABS	720p	Non-backlit	Fingerprint Reader	dTPM 1.2	6-cell (48Wh)	45W	Win8.1 DG Win7 Pro 64	1-year, Depot	01/15
20DF0030US	US	i5-5200U	No	Intel HD 5500	4GBx1	15.6" HD (1366x768)	None	500GB 7200rpm	DVD±RW	Intel 3160 ac, 1x1 + BT4.0	None	None	Black	PC/ABS	720p	Non-backlit	Fingerprint Reader	dTPM 1.2	6-cell (48Wh)	45W	Win8.1 DG Win7 Pro 64	1-year, Depot	01/15
20DF0031US	US	i7-5500U	No	AMD R7 M260 2GB	4GBx1	15.6" HD (1366x768)	None	500GB 7200rpm	DVD±RW	Intel 7265 ac, 2x2 + BT4.0	None	None	Black	PC/ABS	720p	Non-backlit	Fingerprint Reader	None	6-cell (48Wh)	65W	Win8.1 DG Win7 Pro 64	1-year, Depot	01/15
20DF0032US	US	i7-5500U	No	AMD R7 M260 2GB	8GBx1	15.6" HD (1366x768)	None	128GB SSD	DVD±RW	Intel 7265 ac, 2x2 + BT4.0	None	None	Black	PC/ABS	720p	Non-backlit	Fingerprint Reader	None	6-cell (48Wh)	65W	Win8.1 DG Win7 Pro 64	1-year, Depot	01/15
20DF0033US	US	i3-4005U	No	Intel HD 4400	4GBx1	15.6" HD (1366x768)	None	500GB 7200rpm	DVD±RW	Intel 3160 ac, 1x1 + BT4.0	None	None	Black	PC/ABS	720p	Non-backlit	None	dTPM 1.2	6-cell (48Wh)	45W	Win8.1 64-bit	1-year, Depot	01/15
20DF0034US	US	i3-4005U	No	Intel HD 4400	4GBx1	15.6" HD (1366x768)	None	500GB 7200rpm	DVD±RW	Intel 3160 ac, 1x1 + BT4.0	None	None	Black	PC/ABS	720p	Non-backlit	None	dTPM 1.2	6-cell (48Wh)	45W	Win8.1 DG Win7 Pro 64	1-year, Depot	01/15
20DF0035US	US	i3-4005U	No	Intel HD 4400	4GBx1	15.6" HD (1366x768)	None	1TB 5400rpm	DVD±RW	Intel 3160 ac, 1x1 + BT4.0	None	None	Black	PC/ABS	720p	Non-backlit	Fingerprint Reader	dTPM 1.2	6-cell (48Wh)	45W	Win8.1 DG Win7 Pro 64	1-year, Depot	01/15
20DF0036US	US	i3-4005U	No	Intel HD 4400	8GBx1	15.6" HD (1366x768)	None	500GB 7200rpm	DVD±RW	Intel 3160 ac, 1x1 + BT4.0	None	None	Black	PC/ABS	720p	Non-backlit	Fingerprint Reader	dTPM 1.2	6-cell (48Wh)	45W	Win8.1 DG Win7 Pro 64	1-year, Depot	01/15
20DF0037US	US	i3-4005U	No	Intel HD 4400	8GBx1	15.6" HD (1366x768)	None	1TB 5400rpm	DVD±RW	Intel 3160 ac, 1x1 + BT4.0	None	None	Black	PC/ABS	720p	Non-backlit	Fingerprint Reader	dTPM 1.2	6-cell (48Wh)	45W	Win8.1 DG Win7 Pro 64	1-year, Depot	01/15
20DF0038US	US	i3-5005U	No	Intel HD 5500	4GBx1	15.6" HD (1366x768)	None	500GB 7200rpm	DVD±RW	Intel 3160 ac, 1x1 + BT4.0	None	None	Black	PC/ABS	720p	Non-backlit	Fingerprint Reader	dTPM 1.2	6-cell (48Wh)	45W	Win8.1 DG Win7 Pro 64	1-year, Depot	01/15
20DF0039US	US	i3-5005U	No	Intel HD 5500	4GBx1	15.6" HD (1366x768)	None	500GB 7200rpm	DVD±RW	Intel 7265 ac, 2x2 + BT4.0	None	None	Black	PC/ABS	720p	Non-backlit	Fingerprint Reader	dTPM 1.2	6-cell (48Wh)	45W	Win8.1 DG Win7 Pro 64	1-year, Depot	01/15
20DF003AUS	US	i3-5005U	No	Intel HD 5500	4GBx1	15.6" HD (1366x768)	None	1TB 5400rpm	DVD±RW	Intel 7265 ac, 2x2 + BT4.0	None	None	Black	PC/ABS	720p	Non-backlit	Fingerprint Reader	dTPM 1.2	6-cell (48Wh)	45W	Win8.1 DG Win7 Pro 64	1-year, Depot	01/15
20DF003BUS	US	i3-5005U	No	Intel HD 5500	4GBx1	15.6" HD (1366x768)	None	1TB 5400rpm	DVD±RW	Intel 3160 ac, 1x1 + BT4.0	None	None	Black	PC/ABS	720p	Non-backlit	Fingerprint Reader	dTPM 1.2	6-cell (48Wh)	45W	Win8.1 DG Win7 Pro 64	1-year, Depot	01/15
20DF003CUS	US	i3-5005U	No	Intel HD 5500	8GBx1	15.6" HD (1366x768)	None	500GB 7200rpm	DVD±RW	Intel 3160 ac, 1x1 + BT4.0	None	None	Black	PC/ABS	720p	Non-backlit	Fingerprint Reader	dTPM 1.2	6-cell (48Wh)	45W	Win8.1 DG Win7 Pro 64	1-year, Depot	01/15
20DF003DUS	US	i3-5005U	No	Intel HD 5500	8GBx1	15.6" HD (1366x768)	None	500GB 7200rpm	DVD±RW	Intel 7265 ac, 2x2 + BT4.0	None	None	Black	PC/ABS	720p	Non-backlit	Fingerprint Reader	dTPM 1.2	6-cell (48Wh)	45W	Win8.1 DG Win7 Pro 64	1-year, Depot	01/15
20DF003EUS	US	i3-5005U	No	Intel HD 5500	8GBx1	15.6" HD (1366x768)	None	1TB 5400rpm	DVD±RW	Intel 3160 ac, 1x1 + BT4.0	None	None	Black	PC/ABS	720p	Non-backlit	Fingerprint Reader	dTPM 1.2	6-cell (48Wh)	45W	Win8.1 DG Win7 Pro 64	1-year, Depot	01/15
20DF003FUS	US	i5-5200U	No	Intel HD 5500	4GBx1	15.6" HD (1366x768)	None	500GB 7200rpm	DVD±RW	Intel 7265 ac, 2x2 + BT4.0	None	None	Black	PC/ABS	720p	Non-backlit	Fingerprint Reader	dTPM 1.2	6-cell (48Wh)	45W	Win8.1 DG Win7 Pro 64	1-year, Depot	01/15
20DF003GUS	US	i5-5200U	No	Intel HD 5500	4GBx1	15.6" FHD (1920x1080)	None	500GB 7200rpm	DVD±RW	Intel 7265 ac, 2x2 + BT4.0	None	None	Black	PC/ABS	720p	Non-backlit	Fingerprint Reader	dTPM 1.2	6-cell (48Wh)	45W	Win8.1 DG Win7 Pro 64	1-year, Depot	01/15

Model	Region	Processor	vPro	Graphics	Memory	Display	Multi-touch	Storage(HDD/SSD)	Optical	WLAN + Bluetooth	WWAN	SIM Card	Color	Case Material	Camera	Keyboard	Fingerprint Reader	TPM	Battery	Power Adapter	Operating System	Warranty	Ann Date (m/y)
20DF003HUS	US	i5-5200U	No	Intel HD 5500	4GBx1	15.6" HD (1366x768)	None	128GB SSD	DVD±RW	Intel 7265 ac, 2x2 + BT4.0	None	None	Black	PC/ABS	720p	Non-backlit	Fingerprint Reader	dTPM 1.2	6-cell (48Wh)	45W	Win8.1 DG Win7 Pro 64	1-year, Depot	01/15
20DF003JUS	US	i5-5200U	No	Intel HD 5500	4GBx1	15.6" FHD (1920x1080)	None	128GB SSD	DVD±RW	Intel 7265 ac, 2x2 + BT4.0	None	None	Black	PC/ABS	720p	Non-backlit	Fingerprint Reader	dTPM 1.2	6-cell (48Wh)	45W	Win8.1 DG Win7 Pro 64	1-year, Depot	01/15
20DF003KUS	US	i5-5200U	No	Intel HD 5500	4GBx1	15.6" HD (1366x768)	None	1TB 5400rpm	DVD±RW	Intel 3160 ac, 1x1 + BT4.0	None	None	Black	PC/ABS	720p	Non-backlit	Fingerprint Reader	dTPM 1.2	6-cell (48Wh)	45W	Win8.1 DG Win7 Pro 64	1-year, Depot	01/15
20DF003LUS	US	i5-5200U	No	Intel HD 5500	4GBx1	15.6" HD (1366x768)	None	1TB 5400rpm	DVD±RW	Intel 7265 ac, 2x2 + BT4.0	None	None	Black	PC/ABS	720p	Non-backlit	Fingerprint Reader	dTPM 1.2	6-cell (48Wh)	45W	Win8.1 DG Win7 Pro 64	1-year, Depot	01/15
20DF003MUS	US	i5-5200U	No	Intel HD 5500	4GBx1	15.6" FHD (1920x1080)	None	1TB 5400rpm	DVD±RW	Intel 7265 ac, 2x2 + BT4.0	None	None	Black	PC/ABS	720p	Non-backlit	Fingerprint Reader	dTPM 1.2	6-cell (48Wh)	45W	Win8.1 DG Win7 Pro 64	1-year, Depot	01/15
20DF003NUS	US	i5-5200U	No	Intel HD 5500	8GBx1	15.6" HD (1366x768)	None	500GB 7200rpm	DVD±RW	Intel 3160 ac, 1x1 + BT4.0	None	None	Black	PC/ABS	720p	Non-backlit	Fingerprint Reader	dTPM 1.2	6-cell (48Wh)	45W	Win8.1 DG Win7 Pro 64	1-year, Depot	01/15
20DF003PUS	US	i5-5200U	No	Intel HD 5500	8GBx1	15.6" HD (1366x768)	None	500GB 7200rpm	DVD±RW	Intel 7265 ac, 2x2 + BT4.0	None	None	Black	PC/ABS	720p	Non-backlit	Fingerprint Reader	dTPM 1.2	6-cell (48Wh)	45W	Win8.1 DG Win7 Pro 64	1-year, Depot	01/15
20DF003QUS	US	i5-5200U	No	Intel HD 5500	8GBx1	15.6" FHD (1920x1080)	None	500GB 7200rpm	DVD±RW	Intel 7265 ac, 2x2 + BT4.0	None	None	Black	PC/ABS	720p	Non-backlit	Fingerprint Reader	dTPM 1.2	6-cell (48Wh)	45W	Win8.1 DG Win7 Pro 64	1-year, Depot	01/15
20DF003RUS	US	i5-5200U	No	Intel HD 5500	8GBx1	15.6" HD (1366x768)	None	128GB SSD	DVD±RW	Intel 7265 ac, 2x2 + BT4.0	None	None	Black	PC/ABS	720p	Non-backlit	Fingerprint Reader	dTPM 1.2	6-cell (48Wh)	45W	Win8.1 DG Win7 Pro 64	1-year, Depot	01/15
20DF003SUS	US	i5-5200U	No	Intel HD 5500	8GBx1	15.6" FHD (1920x1080)	None	128GB SSD	DVD±RW	Intel 7265 ac, 2x2 + BT4.0	None	None	Black	PC/ABS	720p	Non-backlit	Fingerprint Reader	dTPM 1.2	6-cell (48Wh)	45W	Win8.1 DG Win7 Pro 64	1-year, Depot	01/15
20DF003TUS	US	i5-5200U	No	Intel HD 5500	8GBx1	15.6" HD (1366x768)	None	1TB 5400rpm	DVD±RW	Intel 3160 ac, 1x1 + BT4.0	None	None	Black	PC/ABS	720p	Non-backlit	Fingerprint Reader	dTPM 1.2	6-cell (48Wh)	45W	Win8.1 DG Win7 Pro 64	1-year, Depot	01/15
20DF003UUS	US	i5-5200U	No	Intel HD 5500	8GBx1	15.6" HD (1366x768)	None	1TB 5400rpm	DVD±RW	Intel 7265 ac, 2x2 + BT4.0	None	None	Black	PC/ABS	720p	Non-backlit	Fingerprint Reader	dTPM 1.2	6-cell (48Wh)	45W	Win8.1 DG Win7 Pro 64	1-year, Depot	01/15
20DF003VUS	US	i5-5200U	No	Intel HD 5500	8GBx1	15.6" FHD (1920x1080)	None	1TB 5400rpm	DVD±RW	Intel 7265 ac, 2x2 + BT4.0	None	None	Black	PC/ABS	720p	Non-backlit	Fingerprint Reader	dTPM 1.2	6-cell (48Wh)	45W	Win8.1 DG Win7 Pro 64	1-year, Depot	01/15
20DF003WUS	US	i7-5500U	No	AMD R7 M260 2GB	4GBx1	15.6" FHD (1920x1080)	None	500GB 7200rpm	DVD±RW	Intel 7265 ac, 2x2 + BT4.0	None	None	Black	PC/ABS	720p	Non-backlit	Fingerprint Reader	None	6-cell (48Wh)	65W	Win8.1 DG Win7 Pro 64	1-year, Depot	01/15
20DF003XUS	US	i7-5500U	No	AMD R7 M260 2GB	4GBx1	15.6" FHD (1920x1080)	None	128GB SSD	DVD±RW	Intel 7265 ac, 2x2 + BT4.0	None	None	Black	PC/ABS	720p	Non-backlit	Fingerprint Reader	None	6-cell (48Wh)	65W	Win8.1 DG Win7 Pro 64	1-year, Depot	01/15
20DF003YUS	US	i7-5500U	No	AMD R7 M260 2GB	4GBx1	15.6" FHD (1920x1080)	None	1TB 5400rpm	DVD±RW	Intel 7265 ac, 2x2 + BT4.0	None	None	Black	PC/ABS	720p	Non-backlit	Fingerprint Reader	None	6-cell (48Wh)	65W	Win8.1 DG Win7 Pro 64	1-year, Depot	01/15
20DF0040US	US	i7-5500U	No	AMD R7 M260 2GB	8GBx1	15.6" FHD (1920x1080)	None	500GB 7200rpm	DVD±RW	Intel 7265 ac, 2x2 + BT4.0	None	None	Black	PC/ABS	720p	Non-backlit	Fingerprint Reader	None	6-cell (48Wh)	65W	Win8.1 DG Win7 Pro 64	1-year, Depot	01/15
20DF0041US	US	i7-5500U	No	AMD R7 M260 2GB	8GBx1	15.6" FHD (1920x1080)	None	128GB SSD	DVD±RW	Intel 7265 ac, 2x2 + BT4.0	None	None	Black	PC/ABS	720p	Non-backlit	Fingerprint Reader	None	6-cell (48Wh)	65W	Win8.1 DG Win7 Pro 64	1-year, Depot	01/15
20DF0042US	US	i7-5500U	No	AMD R7 M260 2GB	8GBx1	15.6" FHD (1920x1080)	None	1TB 5400rpm	DVD±RW	Intel 7265 ac, 2x2 + BT4.0	None	None	Black	PC/ABS	720p	Non-backlit	Fingerprint Reader	None	6-cell (48Wh)	65W	Win8.1 DG Win7 Pro 64	1-year, Depot	01/15
20DF0043US	US	i3-4005U	No	Intel HD 4400	4GBx1	15.6" HD (1366x768)	None	500GB 7200rpm	DVD±RW	Intel 3160 ac, 1x1 + BT4.0	None	None	Black	PC/ABS	720p	Non-backlit	None	dTPM 1.2	6-cell (48Wh)	45W	Win8.1 Pro 64-bit	1-year, Depot	01/15

Model	Region	Processor	vPro	Graphics	Memory	Display	Multi-touch	Storage(HDD/SSD)	Optical	WLAN + Bluetooth	WWAN	SIM Card	Color	Case Material	Camera	Keyboard	Fingerprint Reader	TPM	Battery	Power Adapter	Operating System	Warranty	Ann Date (m/y)
20DF0044US	US	i3-4005U	No	Intel HD 4400	8GBx1	15.6" HD (1366x768)	None	500GB 7200rpm	DVD±RW	Intel 3160 ac, 1x1 + BT4.0	None	None	Black	PC/ABS	720p	Non-backlit	None	dTPM 1.2	6-cell (48Wh)	45W	Win8.1 Pro 64-bit	1-year, Depot	01/15
20DF0045US	US	i3-4005U	No	Intel HD 4400	8GBx1	15.6" HD (1366x768)	None	1TB 5400rpm	DVD±RW	Intel 3160 ac, 1x1 + BT4.0	None	None	Black	PC/ABS	720p	Non-backlit	Fingerprint Reader	dTPM 1.2	6-cell (48Wh)	45W	Win8.1 Pro 64-bit	1-year, Depot	01/15
20DF0046US	US	i3-4005U	No	Intel HD 4400	8GBx1	15.6" HD (1366x768)	None	500GB 7200rpm	DVD±RW	Intel 3160 ac, 1x1 + BT4.0	None	None	Black	PC/ABS	720p	Non-backlit	Fingerprint Reader	dTPM 1.2	6-cell (48Wh)	45W	Win8.1 Pro 64-bit	1-year, Depot	01/15
20DF0047US	US	i3-5005U	No	Intel HD 5500	4GBx1	15.6" HD (1366x768)	None	500GB 7200rpm	DVD±RW	Intel 3160 ac, 1x1 + BT4.0	None	None	Black	PC/ABS	720p	Non-backlit	Fingerprint Reader	dTPM 1.2	6-cell (48Wh)	45W	Win8.1 Pro 64-bit	1-year, Depot	01/15
20DF0048US	US	i3-5005U	No	Intel HD 5500	4GBx1	15.6" HD (1366x768)	None	1TB 5400rpm	DVD±RW	Intel 3160 ac, 1x1 + BT4.0	None	None	Black	PC/ABS	720p	Non-backlit	Fingerprint Reader	dTPM 1.2	6-cell (48Wh)	45W	Win8.1 Pro 64-bit	1-year, Depot	01/15
20DF0049US	US	i3-5005U	No	Intel HD 5500	8GBx1	15.6" HD (1366x768)	None	500GB 7200rpm	DVD±RW	Intel 3160 ac, 1x1 + BT4.0	None	None	Black	PC/ABS	720p	Non-backlit	Fingerprint Reader	dTPM 1.2	6-cell (48Wh)	45W	Win8.1 Pro 64-bit	1-year, Depot	01/15
20DF004AUS	US	i3-5005U	No	Intel HD 5500	8GBx1	15.6" HD (1366x768)	None	1TB 5400rpm	DVD±RW	Intel 3160 ac, 1x1 + BT4.0	None	None	Black	PC/ABS	720p	Non-backlit	Fingerprint Reader	dTPM 1.2	6-cell (48Wh)	45W	Win8.1 Pro 64-bit	1-year, Depot	01/15
20DF004BUS	US	i5-5200U	No	Intel HD 5500	4GBx1	15.6" HD (1366x768)	None	500GB 7200rpm	DVD±RW	Intel 3160 ac, 1x1 + BT4.0	None	None	Black	PC/ABS	720p	Non-backlit	Fingerprint Reader	dTPM 1.2	6-cell (48Wh)	45W	Win8.1 Pro 64-bit	1-year, Depot	01/15
20DF004CUS	US	i5-5200U	No	Intel HD 5500	4GBx1	15.6" HD (1366x768)	None	1TB 5400rpm	DVD±RW	Intel 3160 ac, 1x1 + BT4.0	None	None	Black	PC/ABS	720p	Non-backlit	Fingerprint Reader	dTPM 1.2	6-cell (48Wh)	45W	Win8.1 Pro 64-bit	1-year, Depot	01/15
20DF004DUS	US	i5-5200U	No	Intel HD 5500	8GBx1	15.6" HD (1366x768)	None	500GB 7200rpm	DVD±RW	Intel 3160 ac, 1x1 + BT4.0	None	None	Black	PC/ABS	720p	Non-backlit	Fingerprint Reader	dTPM 1.2	6-cell (48Wh)	45W	Win8.1 Pro 64-bit	1-year, Depot	01/15
20DF004EUS	US	i5-5200U	No	Intel HD 5500	8GBx1	15.6" HD (1366x768)	None	1TB 5400rpm	DVD±RW	Intel 3160 ac, 1x1 + BT4.0	None	None	Black	PC/ABS	720p	Non-backlit	Fingerprint Reader	dTPM 1.2	6-cell (48Wh)	45W	Win8.1 Pro 64-bit	1-year, Depot	01/15
20DF00BXUS	US	i3-4005U	No	Intel HD 4400	4GBx1	15.6" HD (1366x768)	None	500GB 7200rpm	DVD±RW	Intel 3160 ac, 1x1 + BT4.0	None	None	Black	PC/ABS	720p	Non-backlit	Fingerprint Reader	dTPM 1.2	6-cell (48Wh)	45W	Win10 Pro 64	1-year, Depot	07/15
20DF00BYUS	US	i7-5500U	No	AMD R7 M260 2GB	8GBx1	15.6" FHD (1920x1080)	None	500GB 7200rpm	DVD±RW	Intel 7265 ac, 2x2 + BT4.0	None	None	Black	PC/ABS	720p	Non-backlit	Fingerprint Reader	None	6-cell (48Wh)	65W	Win10 Pro 64	1-year, Depot	07/15
20DF00C0US	US	i3-4005U	No	Intel HD 4400	4GBx1	15.6" HD (1366x768)	None	500GB 7200rpm	DVD±RW	Intel 3160 ac, 1x1 + BT4.0	None	None	Black	PC/ABS	720p	Non-backlit	Fingerprint Reader	dTPM 1.2	6-cell (48Wh)	45W	Win10 DG Win7 Pro 64	1-year, Depot	07/15
20DF00C1US	US	i7-5500U	No	AMD R7 M260 2GB	8GBx1	15.6" FHD (1920x1080)	None	192GB SSD	DVD±RW	Intel 7265 ac, 2x2 + BT4.0	None	None	Black	PC/ABS	720p	Non-backlit	Fingerprint Reader	None	6-cell (48Wh)	65W	Win10 Pro 64	1-year, Depot	07/15
20DF00C2US	US	i5-5200U	No	Intel HD 5500	4GBx1	15.6" HD (1366x768)	None	500GB 7200rpm	DVD±RW	Intel 3160 ac, 1x1 + BT4.0	None	None	Black	PC/ABS	720p	Non-backlit	Fingerprint Reader	dTPM 1.2	6-cell (48Wh)	45W	Win10 DG Win7 Pro 64	1-year, Depot	07/15
20DF00C3US	US	i7-5500U	No	AMD R7 M260 2GB	8GBx1	15.6" FHD (1920x1080)	None	500GB 7200rpm	DVD±RW	Intel 7265 ac, 2x2 + BT4.0	None	None	Black	PC/ABS	720p	Non-backlit	Fingerprint Reader	None	6-cell (48Wh)	65W	Win10 DG Win7 Pro 64	1-year, Depot	07/15
20DF00C4US	US	i5-5200U	No	Intel HD 5500	4GBx1	15.6" HD (1366x768)	None	500GB 7200rpm	DVD±RW	Intel 3160 ac, 1x1 + BT4.0	None	None	Black	PC/ABS	720p	Non-backlit	Fingerprint Reader	dTPM 1.2	6-cell (48Wh)	45W	Win10 Pro 64	1-year, Depot	07/15
20DF00CAUS	US	i7-5500U	No	AMD R7 M260 2GB	8GBx1	15.6" FHD (1920x1080)	None	192GB SSD	DVD±RW	Intel 7265 ac, 2x2 + BT4.0	None	None	Black	PC/ABS	3D Camera	Non-backlit	Fingerprint Reader	None	6-cell (48Wh)	65W	Win10 Pro 64	1-year, Depot	07/15
20DF00CQUS	US	i3-5005U	No	Intel HD 5500	4GBx1	15.6" HD (1366x768)	None	500GB 7200rpm	DVD±RW	Intel 3160 ac, 1x1 + BT4.0	None	None	Black	PC/ABS	720p	Non-backlit	Fingerprint Reader	dTPM 1.2	6-cell (48Wh)	45W	Win10 DG Win7 Pro 64	1-year, Depot	08/15

Model	Region	Processor	vPro	Graphics	Memory	Display	Multi-touch	Storage(HDD/SSD)	Optical	WLAN + Bluetooth	WWAN	SIM Card	Color	Case Material	Camera	Keyboard	Fingerprint Reader	TPM	Battery	Power Adapter	Operating System	Warranty	Ann Date (m/y)
20DF00EDUS	US	i3-5005U	No	Intel HD 5500	4GBx1	15.6" HD (1366x768)	None	500GB 7200rpm	DVD±RW	Intel 3160 ac, 1x1 + BT4.0	None	None	Black	PC/ABS	0.3MP	Non-backlit	None	dTPM 1.2	6-cell (48Wh)	45W	Win10 DG Win7 Pro 64	1-year, Depot	08/15
20DF00EEUS	US	i3-5005U	No	Intel HD 5500	4GBx1	15.6" HD (1366x768)	None	500GB 7200rpm	DVD±RW	Intel 3160 ac, 1x1 + BT4.0	None	None	Black	PC/ABS	0.3MP	Non-backlit	None	dTPM 1.2	6-cell (48Wh)	45W	Win10 Pro 64	1-year, Depot	08/15
20DF00EFUS	US	i3-5005U	No	Intel HD 5500	4GBx1	15.6" HD (1366x768)	None	500GB 7200rpm	DVD±RW	Intel 3160 ac, 1x1 + BT4.0	None	None	Black	PC/ABS	720p	Non-backlit	Fingerprint Reader	dTPM 1.2	6-cell (48Wh)	45W	Win10 Pro 64	1-year, Depot	08/15
20DF00EGUS	US	i3-5005U	No	Intel HD 5500	4GBx1	15.6" HD (1366x768)	None	192GB SSD	DVD±RW	Intel 3160 ac, 1x1 + BT4.0	None	None	Black	PC/ABS	0.3MP	Non-backlit	None	dTPM 1.2	6-cell (48Wh)	45W	Win10 DG Win7 Pro 64	1-year, Depot	08/15



ThinkPad E560 Platform Specifications

Product Specifications Reference (PSREF)

Processor	6th Generation Intel® Core™ i3 / i5 / i7 Processor and Celeron Processor								Smart Card Reader ExpressCard Multicard Reader Ports Monitor cable Camera Audio support Keyboard UltraNav™ ThinkLight™ Security Security chip vPro Fingerprint reader NFC Battery type Battery life AC adapter Preload Limited warranty Mil-Spec test Environment	None None 4-in-1 reader (MMC, SD, SDHC, SDXC) Three USB 3.0 (one Always On), VGA, HDMI, Ethernet (RJ-45), Lenovo OneLink connector, combo audio/microphone jack None <i>Some:</i> HD720p resolution, fixed focus <i>Some:</i> 3D camera, Intel RealSense™ 3D Camera with MIC HD Audio, Conexant® CX11852 codec, Dolby® Advanced Audio™ / stereo speakers or JBL speakers, 2W x 2 / dual array microphone, combo audio / microphone jack 6-row, spill-resistant, multimedia Fn keys, numeric keypad TrackPoint® pointing device and multi-touch with 3+2 buttons click pad None Power-on password, hard disk password, supervisor password, security keyhole <i>TPM2.0 :</i> Trusted Platform Module, TPM2.0 FW (firmware) <i>TPM1.2:</i> Trusted Platform Module, TCG 1.2-compliant <i>TPM :</i> TPM2.0 and TPM1.2 None <i>Some:</i> Fingerprint reader on the keyboard bezel, swipe sensor None Li-Ion 6-cell (48Wh) 6-cell (48Wh): up to 9.0 hr <i>Some:</i> 45-watt AC adapter (Integrated Graphics) <i>Some:</i> 65-watt AC adapter (Discrete Graphics) <i>Some:</i> No operating system <i>Some:</i> Windows® 7 Professional 64 preinstalled through downgrade rights in Windows 10 Pro 64 • Lenovo Solution Center • Lenovo SHAREit • ThinkVantage Product Recovery • Rescue and Recovery™ • ThinkVantage System Update • PC Device Stage • Adobe® Reader® • Microsoft® Office preloaded; purchase a product key to activate • McAfee® Live Safe (30-day trial) <i>Some:</i> Windows 10 Pro 64 <i>Some:</i> Windows 10 Home 64 • Lenovo Solution Center • Lenovo REACHit • Lenovo SHAREit • Lenovo Companion • Lenovo Settings • ThinkVantage System Update • Microsoft Office preloaded; purchase a product key to activate • McAfee® Live Safe (30-day trial) 1-year - depot repair service / service upgrades available None EPEAT™ Gold; ENERGY STAR®; RoHS-compliant
	Processor Number	# of Cores	# of Threads	Base Frequency	Max Turbo Frequency	Cache	Memory Types	Processor Graphics		
	Cel 3855U	2	2	1.6 GHz	-	2MB	DDR3L-1600	Intel HD Graphics 510		
	i3-6100U	2	4	2.3 GHz	-	3MB		Intel HD Graphics 520		
	i5-6200U			2.3 GHz	2.8 GHz	3MB				
i7-6500U	2.5 GHz			3.1 GHz	4MB					
Graphics	Intel HD Graphics in processor only, or AMD Radeon R7 M370 Graphics, 2GB GDDR5 memory, external analog monitor support via VGA DB-15 connector and digital monitor support via HDMI™ (supporting HDCP to output protected content); supports dual independent displays; Max resolution: 1920x1080 (HDMI)@60Hz									
Chipset Memory	Intel SoC (System on Chip) platform 16GB max / PC3-12800 1600MHz DDR3L, non-parity, dual-channel capable, two 204-pin SO-DIMM sockets									
Display	<i>Some:</i> 15.6" (396mm) HD (1366x768) color, anti-glare, LED backlight, 220 nits, 16:9 aspect ratio <i>Some:</i> 15.6" (396mm) FHD (1920x1080) color, anti-glare, LED backlight, IPS, 250 nits, 16:9 aspect ratio									
Multi-touch	None									
Storage	<i>Some:</i> SSD / SATA 6.0Gb/s, 2.5" wide, 7mm high, removable, upgradable <i>Some:</i> HDD / SATA 6.0Gb/s, 2.5" wide, removable, upgradable, Active Protection System™ <i>Some:</i> SSHD with 8GB NAND flash memory <i>Some:</i> DVD burner, 9.0mm high, removable <i>Some:</i> Blank Bezel									
Optical	None									
M.2 SSD	None									
Ethernet Bluetooth™	Gigabit Ethernet Connection Bluetooth wireless, integrated in Wi-Fi + Bluetooth combo adapter									
WLAN	<i>One of the following, configurable by model:</i> • Intel Dual Band Wireless-AC 3165, 1x1, Wi-Fi + BT combo adapter, M.2 Card • Intel Dual Band Wireless-AC 8260, 2x2, Wi-Fi + BT combo adapter, M.2 Card • BCM, Broadcom Wireless-AC, 1x1, Wi-Fi + Bluetooth combo adapter, M.2 Card • QCA, Qualcomm Wireless-AC, 2x2, Wi-Fi + Bluetooth combo adapter, M.2 Card									
WWAN	None									
SIM card	None									
Dimensions Weight Case color Case material	<i>All (WxDxH):</i> 14.84" x 10.04" x 1.07"; 377mm x 255mm x 27.1mm From 5.39 lb (2.45kg) Graphite Black PolyCarbonate/Acrylonitrile-Butadiene-Styrene (PC/ABS) plastic display cover									

Model	Region	Processor	vPro	Graphics	Memory	Display	Multi-touch	Storage(HDD/SSD)	Optical	WLAN + Bluetooth	WWAN	SIM Card	Color	Case Material	Camera	Keyboard	Fingerprint Reader	TPM	Battery	Power Adapter	Operating System	Warranty	Ann Date (m/y)
20EV0027US	US	i7-6500U	No	AMD R7 M370 2GB	8GBx1	15.6" FHD (1920x1080) IPS	None	192GB SSD	DVD±RW	Intel 8260 ac, 2x2 + BT4.0	None	None	Black	PC/ABS	3D Camera	Non-backlit	Fingerprint Reader	FW TPM 2.0	6-cell (48Wh)	65W	Win10 Pro 64	1-year, Depot	11/15
20EV002DUS	US	i3-6100U	No	Intel HD 520	4GBx1	15.6" HD (1366x768)	None	500GB 7200rpm	DVD±RW	Intel 3165 ac, 1x1 + BT4.0	None	None	Black	PC/ABS	720p	Non-backlit	Fingerprint Reader	dTPM 1.2	6-cell (48Wh)	45W	Win10 DG Win7 Pro 64	1-year, Depot	11/15
20EV002EUS	US	i3-6100U	No	Intel HD 520	4GBx1	15.6" HD (1366x768)	None	192GB SSD	DVD±RW	Intel 3165 ac, 1x1 + BT4.0	None	None	Black	PC/ABS	720p	Non-backlit	Fingerprint Reader	dTPM 1.2	6-cell (48Wh)	45W	Win10 DG Win7 Pro 64	1-year, Depot	11/15
20EV002FUS	US	i5-6200U	No	Intel HD 520	4GBx1	15.6" HD (1366x768)	None	500GB 7200rpm	DVD±RW	Intel 3165 ac, 1x1 + BT4.0	None	None	Black	PC/ABS	720p	Non-backlit	Fingerprint Reader	dTPM 1.2	6-cell (48Wh)	45W	Win10 DG Win7 Pro 64	1-year, Depot	11/15
20EV002GUS	US	i5-6200U	No	Intel HD 520	4GBx1	15.6" HD (1366x768)	None	192GB SSD	DVD±RW	Intel 3165 ac, 1x1 + BT4.0	None	None	Black	PC/ABS	720p	Non-backlit	Fingerprint Reader	dTPM 1.2	6-cell (48Wh)	45W	Win10 DG Win7 Pro 64	1-year, Depot	11/15
20EV002HUS	US	i5-6200U	No	Intel HD 520	8GBx1	15.6" HD (1366x768)	None	192GB SSD	DVD±RW	Intel 3165 ac, 1x1 + BT4.0	None	None	Black	PC/ABS	720p	Non-backlit	Fingerprint Reader	dTPM 1.2	6-cell (48Wh)	45W	Win10 DG Win7 Pro 64	1-year, Depot	11/15
20EV002JUS	US	i7-6500U	No	AMD R7 M370 2GB	8GBx1	15.6" FHD (1920x1080) IPS	None	500GB 7200rpm	DVD±RW	Intel 8260 ac, 2x2 + BT4.0	None	None	Black	PC/ABS	720p	Non-backlit	Fingerprint Reader	FW TPM 2.0	6-cell (48Wh)	65W	Win10 DG Win7 Pro 64	1-year, Depot	11/15
20EV002KUS	US	i7-6500U	No	AMD R7 M370 2GB	8GBx1	15.6" FHD (1920x1080) IPS	None	192GB SSD	DVD±RW	Intel 8260 ac, 2x2 + BT4.0	None	None	Black	PC/ABS	720p	Non-backlit	Fingerprint Reader	FW TPM 2.0	6-cell (48Wh)	65W	Win10 DG Win7 Pro 64	1-year, Depot	11/15
20EV002LLUS	US	i3-6100U	No	Intel HD 520	4GBx1	15.6" HD (1366x768)	None	500GB 7200rpm	DVD±RW	Intel 3165 ac, 1x1 + BT4.0	None	None	Black	PC/ABS	720p	Non-backlit	Fingerprint Reader	dTPM1.2 + FW TPM2.0	6-cell (48Wh)	45W	Win10 Pro 64	1-year, Depot	11/15
20EV002MUS	US	i3-6100U	No	Intel HD 520	4GBx1	15.6" HD (1366x768)	None	192GB SSD	DVD±RW	Intel 3165 ac, 1x1 + BT4.0	None	None	Black	PC/ABS	720p	Non-backlit	Fingerprint Reader	dTPM1.2 + FW TPM2.0	6-cell (48Wh)	45W	Win10 Pro 64	1-year, Depot	11/15
20EV002NUS	US	i5-6200U	No	Intel HD 520	4GBx1	15.6" HD (1366x768)	None	500GB 7200rpm	DVD±RW	Intel 3165 ac, 1x1 + BT4.0	None	None	Black	PC/ABS	720p	Non-backlit	Fingerprint Reader	dTPM1.2 + FW TPM2.0	6-cell (48Wh)	45W	Win10 Pro 64	1-year, Depot	11/15
20EV002PUS	US	i5-6200U	No	Intel HD 520	4GBx1	15.6" HD (1366x768)	None	192GB SSD	DVD±RW	Intel 3165 ac, 1x1 + BT4.0	None	None	Black	PC/ABS	720p	Non-backlit	Fingerprint Reader	dTPM1.2 + FW TPM2.0	6-cell (48Wh)	45W	Win10 Pro 64	1-year, Depot	11/15
20EV002QUS	US	i5-6200U	No	Intel HD 520	8GBx1	15.6" HD (1366x768)	None	192GB SSD	DVD±RW	Intel 3165 ac, 1x1 + BT4.0	None	None	Black	PC/ABS	720p	Non-backlit	Fingerprint Reader	dTPM1.2 + FW TPM2.0	6-cell (48Wh)	45W	Win10 Pro 64	1-year, Depot	11/15
20EV002RUS	US	i7-6500U	No	AMD R7 M370 2GB	8GBx1	15.6" FHD (1920x1080) IPS	None	500GB 7200rpm	DVD±RW	Intel 8260 ac, 2x2 + BT4.0	None	None	Black	PC/ABS	720p	Non-backlit	Fingerprint Reader	FW TPM 2.0	6-cell (48Wh)	65W	Win10 Pro 64	1-year, Depot	11/15
20EV002SUS	US	i7-6500U	No	AMD R7 M370 2GB	8GBx1	15.6" FHD (1920x1080) IPS	None	192GB SSD	DVD±RW	Intel 8260 ac, 2x2 + BT4.0	None	None	Black	PC/ABS	720p	Non-backlit	Fingerprint Reader	FW TPM 2.0	6-cell (48Wh)	65W	Win10 Pro 64	1-year, Depot	11/15
20EV003EUS	US	i7-6500U	No	AMD R7 M370 2GB	8GBx1	15.6" FHD (1920x1080) IPS	None	256GB SSD Opal2	DVD±RW	Intel 8260 ac, 2x2 + BT4.0	None	None	Black	PC/ABS	720p	Non-backlit	Fingerprint Reader	FW TPM 2.0	6-cell (48Wh)	65W	Win10 Pro 64	1-year, Depot	04/16
20EV003FUS	US	i7-6500U	No	AMD R7 M370 2GB	8GBx1	15.6" FHD (1920x1080) IPS	None	256GB SSD Opal2	DVD±RW	Intel 8260 ac, 2x2 + BT4.0	None	None	Black	PC/ABS	720p	Non-backlit	Fingerprint Reader	FW TPM 2.0	6-cell (48Wh)	65W	Win10 DG Win7 Pro 64	1-year, Depot	04/16
20EV003VUS	US	i5-6200U	No	Intel HD 520	4GBx1	15.6" HD (1366x768)	None	256GB SSD Opal2	DVD±RW	Intel 8260 ac, 2x2 + BT4.0	None	None	Black	PC/ABS	720p	Non-backlit	Fingerprint Reader	dTPM 1.2	6-cell (48Wh)	45W	Win10 DG Win7 Pro 64	1-year, Depot	09/16
20EV003WUS	US	i5-6200U	No	Intel HD 520	8GBx1	15.6" FHD (1920x1080) IPS	None	256GB SSD Opal2	DVD±RW	Intel 8260 ac, 2x2 + BT4.0	None	None	Black	PC/ABS	720p	Non-backlit	Fingerprint Reader	dTPM 1.2	6-cell (48Wh)	45W	Win10 DG Win7 Pro 64	1-year, Depot	09/16
20EV0043US	US	i5-6200U	No	Intel HD 520	8GBx1	15.6" FHD (1920x1080) IPS	None	500GB 7200rpm	DVD±RW	Intel 3165 ac, 1x1 + BT4.0	None	None	Black	PC/ABS	720p	Non-backlit	Fingerprint Reader	dTPM1.2 + FW TPM2.0	6-cell (48Wh)	45W	Win10 Pro 64	1-year, Depot	11/16

Model	Region	Processor	vPro	Graphics	Memory	Display	Multi-touch	Storage(HDD/SSD)	Optical	WLAN + Bluetooth	WWAN	SIM Card	Color	Case Material	Camera	Keyboard	Fingerprint Reader	TPM	Battery	Power Adapter	Operating System	Warranty	Ann Date (m/y)
20EVA05UUS	US	i5-6200U	No	Intel HD 520	8GBx1	15.6" HD (1366x768)	None	500GB 7200rpm	DVD±RW	Intel 3165 ac, 1x1 + BT4.0	None	None	Black	PC/ABS	720p	Non-backlit	Fingerprint Reader	dTPM1.2 + FW TPM2.0	6-cell (48Wh)	45W	Win10 Pro 64	1-year, Depot	10/16



ThinkPad E565 Platform Specifications

Product Specifications Reference (PSREF)

Processor	AMD Accelerated Processor A6, A8, A10, or FX APU								Smart Card Reader	None	
	Processor Number	# of Cores	# of Threads	Clock Speed	Max Turbo Frequency	Cache	Memory speed	Graphics	ExpressCard	None	
	A6-8500P	2	6	1.6 GHz	3.0 GHz	1MB	DDR3L-1600	R5 Graphics	Multicard Reader	4-in-1 reader (MMC, SD, SDHC, SDXC)	
	A8-8600P	4	10	1.6 GHz	3.0 GHz	2MB		R6 Graphics	Ports	Three USB 3.0 (one Always On), VGA, HDMI, Ethernet (RJ-45), Lenovo OneLink connector, combo audio/microphone jack	
	A8-8600P	4	10	1.6 GHz	3.0 GHz	2MB		R6 M335DX (R6+R5 M330)	Monitor cable	None	
	A10-8700P	4	10	1.8 GHz	3.2 GHz	2MB		R6 M340DX (R6+R5 M330)	Camera	HD720p resolution, fixed focus	
FX-8800P	4	12	2.1 GHz	3.4 GHz	2MB	R8 M350DX (R7+R5 M330)		Audio support	HD Audio, Conexant® CX11852 codec, Dolby® Advanced Audio™ / stereo speakers, 2W x 2 / dual array microphone, combo audio/microphone jack		
Graphics	AMD Radeon™ R5 or R6 Graphics in processor only, or AMD Radeon R5 M330 Graphics, 2GB DDR3 memory, or Dual Graphics support for A8, A10 and FX APU external analog monitor support via VGA DB-15 connector and digital monitor support via HDMI™ (supporting HDCP to output protected content); supports dual independent display								Keyboard	6-row, spill-resistant, multimedia Fn keys, numeric keypad	
Chipset	AMD SoC (System on Chip) platform								UltraNav™	TrackPoint® pointing device and multi-touch with 3+2 buttons click pad	
Memory	16GB max / PC3-12800 1600MHz DDR3L, non-parity, dual-channel capable, two 204-pin SO-DIMM sockets								ThinkLight™	None	
Display	<i>Some:</i> 15.6" (396mm) HD (1366x768) color, anti-glare, LED backlight, 220 nits, 16:9 aspect ratio <i>Some:</i> 15.6" (396mm) FHD (1920x1080) color, anti-glare, LED backlight, IPS, 250 nits, 16:9 aspect ratio								Security	Power-on password, hard disk password, supervisor password, security keyhole	
Multi-touch	None								Security chip	TPM2.0 : Trusted Platform Module, TPM2.0 FW (firmware) TPM1.2: Trusted Platform Module, TCG 1.2-compliant TPM : TPM2.0 and TPM1.2	
Storage	<i>Some:</i> SSD / SATA 6.0Gb/s, 2.5" wide, 7mm high, removable, upgradable <i>Some:</i> HDD / SATA 6.0Gb/s, 2.5" wide, removable, upgradable, Active Protection System™ <i>Some:</i> SSHD with 8GB NAND flash memory								vPro	None	
Optical	<i>Some:</i> DVD burner, 9.0mm high, removable <i>Some:</i> Blank Bezel								Fingerprint reader	<i>Some:</i> Fingerprint reader on the keyboard bezel, swipe sensor	
M.2 SSD	None								NFC	None	
Ethernet	Gigabit Network Connection								Battery type	Li-Ion 6-cell (48Wh)	
Bluetooth™	Bluetooth wireless, integrated in Wi-Fi + Bluetooth combo adapter								Battery life	Up to 6.5 hr <i>Some:</i> 45-watt AC adapter (Integrated Graphics) <i>Some:</i> 65-watt AC adapter (Discrete Graphics)	
WLAN	<i>One of the following, configurable by model:</i> • BCM, Broadcom Wireless-AC, 1x1, Wi-Fi + Bluetooth combo adapter, M.2 Card • QCA, Qualcomm Wireless-AC, 2x2, Wi-Fi + Bluetooth combo adapter, M.2 Card								AC adapter	<i>Some:</i> 45-watt AC adapter (Integrated Graphics) <i>Some:</i> 65-watt AC adapter (Discrete Graphics)	
WWAN	None								Preload	<i>Some:</i> No operating system <i>Some:</i> Windows® 7 Professional 64 preinstalled through downgrade rights in Windows 10 Pro 64 • Lenovo Solution Center • Lenovo SHAREit • ThinkVantage Product Recovery • Rescue and Recovery™ • ThinkVantage System Update • PC Device Stage • Adobe® Reader® • Microsoft® Office preloaded; purchase a product key to activate • McAfee® Live Safe (30-day trial)	<i>Some:</i> Windows 10 Pro 64 <i>Some:</i> Windows 10 Home 64 • Lenovo Solution Center • Lenovo REACHit • Lenovo SHAREit • Lenovo Companion • Lenovo Settings • ThinkVantage System Update • Microsoft Office preloaded; purchase a product key to activate • McAfee® Live Safe (30-day trial)
SIM card	None								Limited warranty	1-year - depot repair service / service upgrades available	
Dimensions	<i>All (WxDxH):</i> 14.84" x 10.04" x 1.07"; 377mm x 255mm x 27.1mm								Environment	EPEAT™ Gold; ENERGY STAR®; RoHS-compliant	
Weight	From 5.46 lb (2.48kg)										
Case color	Graphite black										
Case material	PolyCarbonate/Acrylonitrile-Butadiene-Styrene (PC/ABS) plastic display cover										

Model	Region	Processor	vPro	Graphics	Memory	Display	Multi-touch	Storage(HDD/SSD)	Optical	WLAN + Bluetooth	WWAN	SIM Card	Color	Case Material	Camera	Keyboard	Fingerprint Reader	TPM	Battery	Power Adapter	Operating System	Warranty	Ann Date (m/y)
20EY0006US	US	AMD A10-8700P	No	AMD R6 M340DX 2GB	8GBx1	15.6" FHD (1920x1080) IPS	None	500GB 5400rpm	DVD±RW	BCM43162 ac, 1x1 + BT4.0	None	None	Black	PC/ABS	720p	Non-backlit	None	FW TPM 2.0	6-cell (48Wh)	65W	Win10 Pro 64	1-year, Depot	11/15
20EY0007US	US	AMD A10-8700P	No	AMD R6 M340DX 2GB	4GBx1	15.6" FHD (1920x1080) IPS	None	192GB SSD	DVD±RW	BCM43162 ac, 1x1 + BT4.0	None	None	Black	PC/ABS	720p	Non-backlit	None	FW TPM 2.0	6-cell (48Wh)	65W	Win10 Pro 64	1-year, Depot	11/15
20EY0008US	US	AMD A6-8500P	No	AMD R5 Graphics	8GBx1	15.6" HD (1366x768)	None	500GB 5400rpm	DVD±RW	BCM43162 ac, 1x1 + BT4.0	None	None	Black	PC/ABS	720p	Non-backlit	None	dTPM 1.2	6-cell (48Wh)	45W	Win10 DG Win7 Pro 64	1-year, Depot	11/15
20EY0009US	US	AMD A10-8700P	No	AMD R6 M340DX 2GB	8GBx1	15.6" HD (1366x768)	None	500GB 5400rpm	DVD±RW	BCM43162 ac, 1x1 + BT4.0	None	None	Black	PC/ABS	720p	Non-backlit	None	FW TPM 2.0	6-cell (48Wh)	65W	Win10 Pro 64	1-year, Depot	11/15
20EY000AUS	US	AMD A6-8500P	No	AMD R5 Graphics	4GBx1	15.6" HD (1366x768)	None	500GB 5400rpm	DVD±RW	BCM43162 ac, 1x1 + BT4.0	None	None	Black	PC/ABS	720p	Non-backlit	None	dTPM 1.2	6-cell (48Wh)	45W	Win10 DG Win7 Pro 64	1-year, Depot	11/15
20EY000BUS	US	AMD A10-8700P	No	AMD R6 M340DX 2GB	8GBx1	15.6" HD (1366x768)	None	500GB 5400rpm	DVD±RW	BCM43162 ac, 1x1 + BT4.0	None	None	Black	PC/ABS	720p	Non-backlit	None	FW TPM 2.0	6-cell (48Wh)	65W	Win10 DG Win7 Pro 64	1-year, Depot	11/15
20EY000CUS	US	AMD A10-8700P	No	AMD R6 M340DX 2GB	4GBx1	15.6" HD (1366x768)	None	500GB 5400rpm	DVD±RW	BCM43162 ac, 1x1 + BT4.0	None	None	Black	PC/ABS	720p	Non-backlit	None	FW TPM 2.0	6-cell (48Wh)	65W	Win10 DG Win7 Pro 64	1-year, Depot	11/15
20EY000DUS	US	AMD A10-8700P	No	AMD R6 M340DX 2GB	8GBx1	15.6" FHD (1920x1080) IPS	None	192GB SSD	DVD±RW	BCM43162 ac, 1x1 + BT4.0	None	None	Black	PC/ABS	720p	Non-backlit	None	FW TPM 2.0	6-cell (48Wh)	65W	Win10 DG Win7 Pro 64	1-year, Depot	11/15
20EY000EUS	US	AMD A10-8700P	No	AMD R6 M340DX 2GB	8GBx1	15.6" FHD (1920x1080) IPS	None	500GB 5400rpm	DVD±RW	BCM43162 ac, 1x1 + BT4.0	None	None	Black	PC/ABS	720p	Non-backlit	None	FW TPM 2.0	6-cell (48Wh)	65W	Win10 DG Win7 Pro 64	1-year, Depot	11/15
20EY000FUS	US	AMD A6-8500P	No	AMD R5 Graphics	8GBx1	15.6" HD (1366x768)	None	500GB 5400rpm	DVD±RW	BCM43162 ac, 1x1 + BT4.0	None	None	Black	PC/ABS	720p	Non-backlit	None	dTPM1.2 + FW TPM2.0	6-cell (48Wh)	45W	Win10 Pro 64	1-year, Depot	11/15
20EY000GUS	US	AMD A10-8700P	No	AMD R6 M340DX 2GB	4GBx1	15.6" FHD (1920x1080) IPS	None	192GB SSD	DVD±RW	BCM43162 ac, 1x1 + BT4.0	None	None	Black	PC/ABS	720p	Non-backlit	None	FW TPM 2.0	6-cell (48Wh)	65W	Win10 DG Win7 Pro 64	1-year, Depot	11/15
20EY000HUS	US	AMD A10-8700P	No	AMD R6 M340DX 2GB	8GBx1	15.6" FHD (1920x1080) IPS	None	192GB SSD	DVD±RW	BCM43162 ac, 1x1 + BT4.0	None	None	Black	PC/ABS	720p	Non-backlit	None	FW TPM 2.0	6-cell (48Wh)	65W	Win10 Pro 64	1-year, Depot	11/15
20EY000JUS	US	AMD A10-8700P	No	AMD R6 M340DX 2GB	4GBx1	15.6" HD (1366x768)	None	500GB 5400rpm	DVD±RW	BCM43162 ac, 1x1 + BT4.0	None	None	Black	PC/ABS	720p	Non-backlit	None	FW TPM 2.0	6-cell (48Wh)	65W	Win10 Pro 64	1-year, Depot	11/15
20EY000KUS	US	AMD A6-8500P	No	AMD R5 Graphics	4GBx1	15.6" HD (1366x768)	None	500GB 5400rpm	DVD±RW	BCM43162 ac, 1x1 + BT4.0	None	None	Black	PC/ABS	720p	Non-backlit	None	dTPM1.2 + FW TPM2.0	6-cell (48Wh)	45W	Win10 Pro 64	1-year, Depot	11/15
20EY001EUS	US	AMD A10-8700P	No	AMD R6 M340DX 2GB	8GBx1	15.6" HD (1366x768)	None	500GB 5400rpm	DVD±RW	QCA435 ac, 1x1 + BT4.0	None	None	Black	PC/ABS	720p	Non-backlit	None	FW TPM 2.0	6-cell (48Wh)	65W	Win10 DG Win7 Pro 64	1-year, Depot	06/16
20EY001FUS	US	AMD A10-8700P	No	AMD R6 M340DX 2GB	8GBx1	15.6" FHD (1920x1080) IPS	None	500GB 5400rpm	DVD±RW	QCA435 ac, 1x1 + BT4.0	None	None	Black	PC/ABS	720p	Non-backlit	None	FW TPM 2.0	6-cell (48Wh)	65W	Win10 DG Win7 Pro 64	1-year, Depot	06/16
20EY001GUS	US	AMD A6-8500P	No	AMD R5 Graphics	4GBx1	15.6" HD (1366x768)	None	500GB 5400rpm	DVD±RW	QCA435 ac, 1x1 + BT4.0	None	None	Black	PC/ABS	720p	Non-backlit	None	dTPM1.2 + FW TPM2.0	6-cell (48Wh)	45W	Win10 Pro 64	1-year, Depot	06/16
20EY001HUS	US	AMD A6-8500P	No	AMD R5 Graphics	8GBx1	15.6" HD (1366x768)	None	500GB 5400rpm	DVD±RW	QCA435 ac, 1x1 + BT4.0	None	None	Black	PC/ABS	720p	Non-backlit	None	dTPM1.2 + FW TPM2.0	6-cell (48Wh)	45W	Win10 Pro 64	1-year, Depot	06/16
20EY001JUS	US	AMD A10-8700P	No	AMD R6 M340DX 2GB	8GBx1	15.6" FHD (1920x1080) IPS	None	192GB SSD	DVD±RW	QCA435 ac, 1x1 + BT4.0	None	None	Black	PC/ABS	720p	Non-backlit	None	FW TPM 2.0	6-cell (48Wh)	65W	Win10 DG Win7 Pro 64	1-year, Depot	06/16
20EY001KUS	US	AMD A10-8700P	No	AMD R6 M340DX 2GB	8GBx1	15.6" FHD (1920x1080) IPS	None	500GB 5400rpm	DVD±RW	QCA435 ac, 1x1 + BT4.0	None	None	Black	PC/ABS	720p	Non-backlit	None	FW TPM 2.0	6-cell (48Wh)	65W	Win10 Pro 64	1-year, Depot	06/16

Model	Region	Processor	vPro	Graphics	Memory	Display	Multi-touch	Storage(HDD/SSD)	Optical	WLAN + Bluetooth	WWAN	SIM Card	Color	Case Material	Camera	Keyboard	Fingerprint Reader	TPM	Battery	Power Adapter	Operating System	Warranty	Ann Date (m/y)
20EY001LUS	US	AMD A10-8700P	No	AMD R6 M340DX 2GB	4GBx1	15.6" FHD (1920x1080) IPS	None	192GB SSD	DVD±RW	QCA435 ac, 1x1 + BT4.0	None	None	Black	PC/ABS	720p	Non-backlit	None	FW TPM 2.0	6-cell (48Wh)	65W	Win10 DG Win7 Pro 64	1-year, Depot	06/16
20EY001MUS	US	AMD A10-8700P	No	AMD R6 M340DX 2GB	4GBx1	15.6" FHD (1920x1080) IPS	None	500GB 5400rpm	DVD±RW	QCA435 ac, 1x1 + BT4.0	None	None	Black	PC/ABS	720p	Non-backlit	None	FW TPM 2.0	6-cell (48Wh)	65W	Win10 DG Win7 Pro 64	1-year, Depot	06/16
20EY001NUS	US	AMD A10-8700P	No	AMD R6 M340DX 2GB	4GBx1	15.6" HD (1366x768)	None	500GB 5400rpm	DVD±RW	QCA435 ac, 1x1 + BT4.0	None	None	Black	PC/ABS	720p	Non-backlit	None	FW TPM 2.0	6-cell (48Wh)	65W	Win10 DG Win7 Pro 64	1-year, Depot	06/16
20EY001PUS	US	AMD A10-8700P	No	AMD R6 M340DX 2GB	8GBx1	15.6" HD (1366x768)	None	500GB 5400rpm	DVD±RW	QCA435 ac, 1x1 + BT4.0	None	None	Black	PC/ABS	720p	Non-backlit	None	FW TPM 2.0	6-cell (48Wh)	65W	Win10 Pro 64	1-year, Depot	06/16
20EY001QUS	US	AMD A10-8700P	No	AMD R6 M340DX 2GB	4GBx1	15.6" HD (1366x768)	None	500GB 5400rpm	DVD±RW	QCA435 ac, 1x1 + BT4.0	None	None	Black	PC/ABS	720p	Non-backlit	None	FW TPM 2.0	6-cell (48Wh)	65W	Win10 Pro 64	1-year, Depot	06/16
20EY001RUS	US	AMD A6-8500P	No	AMD R5 Graphics	8GBx1	15.6" HD (1366x768)	None	500GB 5400rpm	DVD±RW	QCA435 ac, 1x1 + BT4.0	None	None	Black	PC/ABS	720p	Non-backlit	None	dTPM 1.2	6-cell (48Wh)	45W	Win10 DG Win7 Pro 64	1-year, Depot	06/16
20EY001SUS	US	AMD A10-8700P	No	AMD R6 M340DX 2GB	8GBx1	15.6" FHD (1920x1080) IPS	None	192GB SSD	DVD±RW	QCA435 ac, 1x1 + BT4.0	None	None	Black	PC/ABS	720p	Non-backlit	None	FW TPM 2.0	6-cell (48Wh)	65W	Win10 Pro 64	1-year, Depot	06/16
20EY001TUS	US	AMD A10-8700P	No	AMD R6 M340DX 2GB	4GBx1	15.6" FHD (1920x1080) IPS	None	192GB SSD	DVD±RW	QCA435 ac, 1x1 + BT4.0	None	None	Black	PC/ABS	720p	Non-backlit	None	FW TPM 2.0	6-cell (48Wh)	65W	Win10 Pro 64	1-year, Depot	06/16
20EY001UUS	US	AMD A10-8700P	No	AMD R6 M340DX 2GB	4GBx1	15.6" FHD (1920x1080) IPS	None	500GB 5400rpm	DVD±RW	QCA435 ac, 1x1 + BT4.0	None	None	Black	PC/ABS	720p	Non-backlit	None	FW TPM 2.0	6-cell (48Wh)	65W	Win10 Pro 64	1-year, Depot	06/16
20EY001VUS	US	AMD A6-8500P	No	AMD R5 Graphics	4GBx1	15.6" HD (1366x768)	None	500GB 5400rpm	DVD±RW	QCA435 ac, 1x1 + BT4.0	None	None	Black	PC/ABS	720p	Non-backlit	None	dTPM 1.2	6-cell (48Wh)	45W	Win10 DG Win7 Pro 64	1-year, Depot	06/16

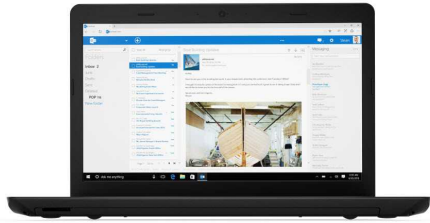

ThinkPad E570 Platform Specifications

Product Specifications Reference (PSREF)

Processor	7th Generation Intel® Core™ i3 / i5 / i7 Processor								Dimensions <i>Aluminum (WxDxH):</i> 14.92" x 10.28" x 0.94" 379mm x 261mm x 23.9mm <i>PC/ABS (WxDxH):</i> 14.92" x 10.28" x 1.00"; 379mm x 261mm x 25.4mm
	Processor Number	# of Cores	# of Threads	Base Frequency	Max Turbo Frequency	Cache	Memory Types	Processor Graphics	
	i3-7100U	2	4	2.4 GHz	-	3MB	DDR4-2133	Intel HD Graphics 620	
	i5-7200U			2.5 GHz	3.1 GHz	3MB			
i7-7500U	2.7 GHz			3.5 GHz	4MB				
Graphics	Intel HD Graphics in processor only, or NVidia GeForce 940MX Graphics, 2GB DDR5 memory, or NVidia GeForce GTX 950MX Graphics, 2GB DDR5 memory, external analog monitor support via VGA DB-15 connector and digital monitor support via HDMI™ (supporting HDCP to output protected content); supports dual independent displays; Max resolution: 1920x1080 (HDMI)@60Hz								Weight Case color Case material (LCD Rear)
Memory	32GB max / PC4-19200 2400MHz DDR4, non-parity, dual-channel capable, two 260-pin SO-DIMM sockets								Camera Audio support
Display	Some: 15.6" (396mm) HD (1366x768), anti-glare, LED backlight, 220 nits, 16:9 aspect ratio, 400:1 contrast ratio Some: 15.6" (396mm) FHD (1920x1080), anti-glare, LED backlight, IPS, 250 nits, 16:9 aspect ratio, 600:1 contrast ratio								Keyboard UltraNav™ ThinkLight™
Multi-touch	None								Fingerprint reader NFC Security Security chip
Storage	Some: M.2 SSD / SATA 6.0Gb/s Some: M.2 SSD / PCIe NVMe Some: HDD / SATA 6.0Gb/s, 2.5" wide, removable, upgradable, Active Protection System™								vPro
Optical	Some: DVD burner, 9.0mm high, removable Some: Blank Bezel								Battery type Battery life AC adapter
Ethernet	Gigabit Ethernet Connection, Realtek R8111GUS								Preload
WLAN	One of the following, configurable by model: • Intel Dual Band Wireless-AC 8265, 2x2, Wi-Fi + BT combo adapter, M.2 Card • QCA, Qualcomm 344A-AC, 2x2, Wi-Fi + Bluetooth combo adapter, M.2 Card • QCA, Qualcomm 435-AC, 1x1, Wi-Fi + Bluetooth combo adapter, M.2 Card								Some: Windows 10 Pro 64 Some: Windows 10 Home 64 • Lenovo Companion • Lenovo Settings • Microsoft Office preloaded; purchase a product key to activate • McAfee® Live Safe (30-day trial)
Bluetooth™	Bluetooth wireless, integrated in Wi-Fi + Bluetooth combo adapter								
WWAN SIM card	None None								
Smart Card Reader ExpressCard Dock Multicard Reader	None None None 4-in-1 reader (MMC, SD, SDHC, SDXC)								Limited warranty
Ports	Two USB 3.0, one USB 2.0 (Always On), VGA, HDMI, Ethernet (RJ-45), combo audio / microphone jack, optional one USB 3.1 Type-C (standard for i5, i7 models in EMEA)								Mil-Spec test
Monitor cable	None								Environment

Model	Region	Processor	vPro	Graphics	Memory	Display	Multi-touch	Storage(HDD/SSD)	Optical	WLAN + Bluetooth	WWAN	SIM Card	Color (LCD Rear, Top Cover)	Case Material	Optional Ports	Fingerprint Reader	TPM	Battery	Power Adapter	Operating System	Warranty	Ann Date (m/y)
20H50042US	US	i3-7100U	No	Intel HD 620	4GBx1	15.6" HD (1366x768)	None	500GB 7200rpm	DVD±RW	11ac, 1x1 + BT4.1	None	None	Black, Black	PC/ABS	None	Fingerprint Reader	dTPM 2.0	4-cell (41Wh)	45W	Windows 10 Pro 64	1-year, Depot	09/16
20H50043US	US	i7-7500U	No	GTX 950MX 2GB	8GBx1	15.6" FHD (1920x1080) IPS	None	500GB 7200rpm	DVD±RW	Intel 8265 ac, 2x2 + BT4.1	None	None	Black, Black	PC/ABS	None	Fingerprint Reader	FW TPM 2.0	4-cell (41Wh)	90W	Windows 10 Pro 64	1-year, Depot	09/16
20H50044US	US	i3-6006U	No	Intel HD 520	4GBx1	15.6" HD (1366x768)	None	500GB 7200rpm	DVD±RW	11ac, 1x1 + BT4.1	None	None	Black, Black	PC/ABS	None	None	dTPM 2.0	4-cell (41Wh)	45W	Windows 10 Pro 64	1-year, Depot	11/16
20H50045US	US	i5-7200U	No	Intel HD 620	8GBx1	15.6" FHD (1920x1080) IPS	None	256GB SSD PCIe NVMe Opal2	DVD±RW	Intel 8265 ac, 2x2 + BT4.1	None	None	Black, Black	PC/ABS	None	Fingerprint Reader	dTPM 2.0	4-cell (41Wh)	45W	Windows 10 Pro 64	1-year, Depot	09/16
20H50047US	US	i7-7500U	No	GTX 950MX 2GB	8GBx1	15.6" FHD (1920x1080) IPS	None	256GB SSD PCIe NVMe Opal2	DVD±RW	Intel 8265 ac, 2x2 + BT4.1	None	None	Black, Black	PC/ABS	None	Fingerprint Reader	FW TPM 2.0	4-cell (41Wh)	90W	Windows 10 Pro 64	1-year, Depot	09/16
20H50048US	US	i5-7200U	No	Intel HD 620	4GBx1	15.6" HD (1366x768)	None	500GB 7200rpm	DVD±RW	11ac, 1x1 + BT4.1	None	None	Black, Black	PC/ABS	None	Fingerprint Reader	dTPM 2.0	4-cell (41Wh)	45W	Windows 10 Pro 64	1-year, Depot	09/16
20H5007UUS	US	i3-7100U	No	Intel HD 620	4GBx1	15.6" HD (1366x768)	None	180GB SSD Opal2	DVD±RW	11ac, 1x1 + BT4.1	None	None	Black, Black	PC/ABS	None	Fingerprint Reader	dTPM 2.0	4-cell (41Wh)	45W	Windows 10 Pro 64	1-year, Depot	01/17
20H5007VUS	US	i5-6200U	No	940MX 2GB	8GBx1	15.6" HD (1366x768)	None	180GB SSD Opal2	DVD±RW	11ac, 1x1 + BT4.1	None	None	Black, Black	PC/ABS	None	Fingerprint Reader	FW TPM 2.0	4-cell (41Wh)	65W	Windows 10 Pro 64	1-year, Depot	01/17
20H5007WUS	US	i5-6200U	No	940MX 2GB	4GBx1	15.6" HD (1366x768)	None	180GB SSD Opal2	DVD±RW	11ac, 1x1 + BT4.1	None	None	Black, Black	PC/ABS	None	Fingerprint Reader	FW TPM 2.0	4-cell (41Wh)	65W	Windows 10 Pro 64	1-year, Depot	01/17

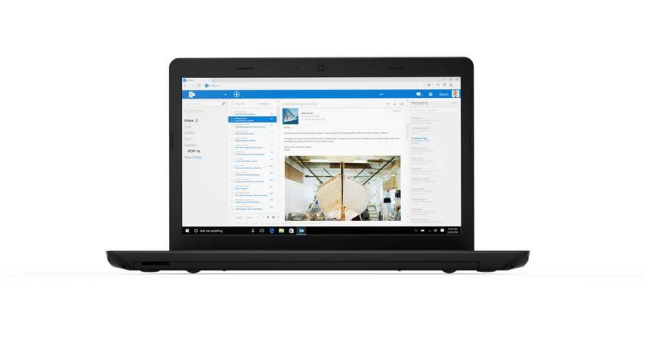

ThinkPad E575 Platform Specifications

Product Specifications Reference (PSREF)

Processor	AMD Accelerated Processor A6, A10, or A12 APU								Dimensions Weight Case color Case material	<i>PC/ABS (WxDxH):</i> 14.92" x 10.28" x 1.00"; 379mm x 261mm x 25.4mm From 5.07 lb (2.30kg) Black <i>PC/ABS:</i> PolyCarbonate/Acrylonitrile-Butadiene-Styrene display cover
	Processor Number	# of Cores	# of Threads	Base Frequency	Max Turbo Frequency	Cache	Memory Types	Processor Graphics		
	A6-9500B	2	4	2.3 GHz	3.2 GHz	2MB	DDR4-1866	R5 Graphics		
	A10-9600P	4	8	2.4 GHz	3.3 GHz	2MB		R5 Graphics		
A12-9700P	4	8	2.5 GHz	3.4 GHz	2MB	R7 Graphics				
Graphics	AMD Radeon™ R5 Graphics in processor only, or AMD Radeon R5 M430 Graphics, 2GB DDR3 memory, or external analog monitor support via VGA DB-15 connector and digital monitor support via HDMI™ (supporting HDCP to output protected content); supports dual independent displays; Max resolution: 1920x1080 (HDMI)@60Hz								Camera Audio support	<i>Some:</i> HD720p resolution, fixed focus HD Audio, Conexant® CX11852 codec, Dolby® Audio™ Premium / stereo speakers, 2W x 2 / dual array microphone, combo audio / microphone jack
Chipset	AMD SoC (System on Chip) platform								Keyboard	6-row, spill-resistant, multimedia Fn keys
Memory	32GB max / PC4-19200 2400MHz DDR4, non-parity, dual-channel capable, two 260-pin SO-DIMM sockets *System automatically clocks down with 1866MHz DDR4 memory controller								UltraNav™ ThinkLight™	TrackPoint® pointing device and multi-touch with 3+2 buttons click pad None
Display	Some: 15.6" (396mm) HD (1366x768), anti-glare, LED backlight, 220 nits, 16:9 aspect ratio, 400:1 contrast ratio Some: 15.6" (396mm) FHD (1920x1080), anti-glare, LED backlight, IPS, 250 nits, 16:9 aspect ratio, 600:1 contrast ratio								Fingerprint reader	None
Multi-touch	None								NFC	None
Storage	<i>Some:</i> SSD / SATA 6.0Gb/s, 2.5" wide, 7mm high, removable, upgradable <i>Some:</i> HDD / SATA 6.0Gb/s, 2.5" wide, removable, upgradable, Active Protection System™								Security	Power-on password, hard disk password, supervisor password, security keyhole
Optical	<i>Some:</i> DVD burner, 9.0mm high, removable <i>Some:</i> Blank Bezel								Security chip	<i>FW TPM2.0:</i> Firmware TPM 2.0, integrated in chipset <i>dTPM2.0:</i> Discrete TPM 2.0, TCG Certified
Ethernet	Gigabit Ethernet Connection, Realtek R8111GUS								vPro	No
WLAN	<i>One of the following, configurable by model:</i> • QCA, Qualcomm 344A-AC, 2x2, Wi-Fi + Bluetooth combo adapter, M.2 Card • QCA, Qualcomm 435-AC, 1x1, Wi-Fi + Bluetooth combo adapter, M.2 Card Bluetooth wireless, integrated in Wi-Fi + Bluetooth combo adapter								Battery type	<i>Some:</i> Li-Ion 4-cell (41Wh)
Bluetooth™									Battery life	<i>Some:</i> Up to 6.5 hr
WWAN	None								AC adapter	<i>Some:</i> 45-watt AC adapter <i>Some:</i> 65-watt AC adapter
SIM card	None								Preload	<i>Some:</i> Windows 10 Pro 64 <i>Some:</i> Windows 10 Home 64 • Lenovo Companion • Lenovo Settings • Microsoft Office preloaded; purchase a product key to activate • McAfee® Live Safe (30-day trial) <i>Some:</i> No operating system
Smart Card Reader	None								Limited warranty	1-year - depot repair service / service upgrades available
ExpressCard	None								Mil-Spec test	None
Dock	None								Environment	EPEAT™ Gold; ENERGY STAR®; RoHS-compliant
Multicard Reader	4-in-1 reader (MMC, SD, SDHC, SDXC)									
Ports	Two USB 3.0, one USB 2.0 (Always On), VGA, HDMI, Ethernet (RJ-45), combo audio / microphone jack									
Monitor cable	None									

ThinkPad E575 - TopSeller - 20H8

Product Specifications Reference (PSREF)

Model	Region	Processor	vPro	Graphics	Memory	Display	Multi-touch	Storage(HDD/SSD)	Optical	WLAN + Bluetooth	WWAN	SIM Card	Color	Case Material	Camera	Keyboard	Fingerprint Reader	TPM	Battery	Power Adapter	Operating System	Warranty	Ann Date (m/y)
20H8000CUS	US	AMD A10-9600P	No	AMD R5 M430 2GB	4GBx1	15.6" HD (1366x768)	None	500GB 7200rpm	DVD±RW	QCA435ac, 1x1 + BT4.1	None	None	Black	PC/ABS	720p	Non-backlit	None	FW TPM 2.0	4-cell (41Wh)	65W	Windows 10 Pro 64	1-year, Depot	11/16
20H8000DUS	US	AMD A10-9600P	No	AMD R5 M430 2GB	8GBx1	15.6" FHD (1920x1080) IPS	None	500GB 7200rpm	DVD±RW	QCA435ac, 1x1 + BT4.1	None	None	Black	PC/ABS	720p	Non-backlit	None	FW TPM 2.0	4-cell (41Wh)	65W	Windows 10 Pro 64	1-year, Depot	11/16
20H8000EUS	US	AMD A10-9600P	No	AMD R5 M430 2GB	8GBx1	15.6" HD (1366x768)	None	500GB 7200rpm	DVD±RW	QCA435ac, 1x1 + BT4.1	None	None	Black	PC/ABS	720p	Non-backlit	None	FW TPM 2.0	4-cell (41Wh)	65W	Windows 10 Pro 64	1-year, Depot	11/16
20H8000FUS	US	AMD A6-9500B	No	AMD R5 Graphics	8GBx1	15.6" HD (1366x768)	None	500GB 7200rpm	DVD±RW	QCA435ac, 1x1 + BT4.1	None	None	Black	PC/ABS	720p	Non-backlit	None	dTPM 1.2	4-cell (41Wh)	45W	Windows 10 Pro 64	1-year, Depot	11/16
20H8000GUS	US	AMD A10-9600P	No	AMD R5 M430 2GB	8GBx1	15.6" FHD (1920x1080) IPS	None	256GB SSD Opal2	DVD±RW	QCA435ac, 1x1 + BT4.1	None	None	Black	PC/ABS	720p	Non-backlit	None	FW TPM 2.0	4-cell (41Wh)	65W	Windows 10 Pro 64	1-year, Depot	11/16
20H8000HUS	US	AMD A6-9500B	No	AMD R5 Graphics	4GBx1	15.6" HD (1366x768)	None	500GB 7200rpm	DVD±RW	QCA435ac, 1x1 + BT4.1	None	None	Black	PC/ABS	720p	Non-backlit	None	dTPM 1.2	4-cell (41Wh)	45W	Windows 10 Pro 64	1-year, Depot	11/16
20H8000QUS	US	AMD A10-9600P	No	AMD R5 M430 2GB	8GBx1	15.6" HD (1366x768)	None	180GB SSD Opal2	DVD±RW	QCA435ac, 1x1 + BT4.1	None	None	Black	PC/ABS	720p	Non-backlit	None	FW TPM 2.0	4-cell (41Wh)	65W	Windows 10 Pro 64	1-year, Depot	01/17

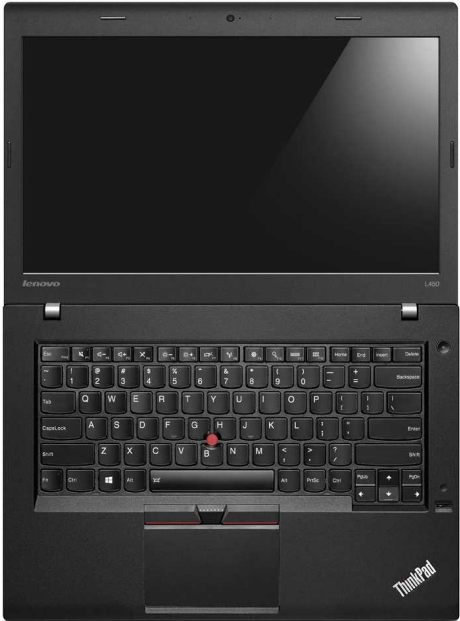

ThinkPad L450 Platform Specifications

Product Specifications Reference (PSREF)

Processor	Intel® Celeron® processor, 4th Generation Intel Core™ i5 Processor, or 5th Generation Intel Core i3 / i5 / i7 Processor	Dimensions ³	14.0" (WxDxH): 13.34" x 9.23" x 0.95"; 339mm x 235mm x 24.3mm																																																	
	<table border="1"> <thead> <tr> <th>Processor Number</th> <th># of Cores</th> <th># of Threads</th> <th>Base Frequency</th> <th>Max Turbo Frequency</th> <th>Cache</th> <th>Memory Types</th> <th>Processor Graphics</th> </tr> </thead> <tbody> <tr> <td>Cel 3205U</td> <td rowspan="6">2</td> <td rowspan="6">4</td> <td>1.5 GHz</td> <td>-</td> <td>2MB</td> <td rowspan="6">DDR3L-1600</td> <td>Intel HD Graphics</td> </tr> <tr> <td>i5-4300U</td> <td>1.9 GHz</td> <td>2.9 GHz</td> <td>3MB</td> <td>Intel HD Graphics 4400</td> </tr> <tr> <td>i3-5005U</td> <td>2 GHz</td> <td>-</td> <td>3MB</td> <td rowspan="4">Intel HD Graphics 5500</td> </tr> <tr> <td>i5-5200U</td> <td>2.2 GHz</td> <td>2.7 GHz</td> <td>3MB</td> </tr> <tr> <td>i5-5300U</td> <td>2.3 GHz</td> <td>2.9 GHz</td> <td>3MB</td> </tr> <tr> <td>i7-5500U</td> <td>2.4 GHz</td> <td>3 GHz</td> <td>4MB</td> </tr> </tbody> </table>	Processor Number	# of Cores	# of Threads	Base Frequency	Max Turbo Frequency	Cache	Memory Types	Processor Graphics	Cel 3205U	2	4	1.5 GHz	-	2MB	DDR3L-1600	Intel HD Graphics	i5-4300U	1.9 GHz	2.9 GHz	3MB	Intel HD Graphics 4400	i3-5005U	2 GHz	-	3MB	Intel HD Graphics 5500	i5-5200U	2.2 GHz	2.7 GHz	3MB	i5-5300U	2.3 GHz	2.9 GHz	3MB	i7-5500U	2.4 GHz	3 GHz	4MB	Weight ²	<table border="1"> <thead> <tr> <th>Models</th> <th>3-cell</th> <th>6-cell</th> </tr> </thead> <tbody> <tr> <td>Integrated</td> <td>4.25 lb / 1.93 kg</td> <td>4.43 lb / 2.01 kg</td> </tr> <tr> <td>Discrete</td> <td>4.30 lb / 1.95 kg</td> <td>4.50 lb / 2.04 kg</td> </tr> </tbody> </table>			Models	3-cell	6-cell	Integrated	4.25 lb / 1.93 kg	4.43 lb / 2.01 kg	Discrete	4.30 lb / 1.95 kg	4.50 lb / 2.04 kg
Processor Number	# of Cores	# of Threads	Base Frequency	Max Turbo Frequency	Cache	Memory Types	Processor Graphics																																													
Cel 3205U	2	4	1.5 GHz	-	2MB	DDR3L-1600	Intel HD Graphics																																													
i5-4300U			1.9 GHz	2.9 GHz	3MB		Intel HD Graphics 4400																																													
i3-5005U			2 GHz	-	3MB		Intel HD Graphics 5500																																													
i5-5200U			2.2 GHz	2.7 GHz	3MB																																															
i5-5300U			2.3 GHz	2.9 GHz	3MB																																															
i7-5500U			2.4 GHz	3 GHz	4MB																																															
Models	3-cell	6-cell																																																		
Integrated	4.25 lb / 1.93 kg	4.43 lb / 2.01 kg																																																		
Discrete	4.30 lb / 1.95 kg	4.50 lb / 2.04 kg																																																		
		Case material	PolyCarbonate/Acrylonitrile-Butadiene-Styrene (PC/ABS) plastic																																																	
		Smart card reader	<i>Optional:</i> Smart card reader																																																	
		Media reader	4-in-1 reader (MMC, SD, SDHC, SDXC)																																																	
		Ports	Three USB 3.0 (one Always On), VGA, Mini DisplayPort, Ethernet (RJ-45), Dock connector (integrated models only)																																																	
		Camera (<i>optional</i>)	HD720p resolution, low light sensitive, fixed focus																																																	
		Audio support	HD Audio, Realtek® ALC3232 codec / stereo speakers, 2W x 2 / dual array microphone, combo audio/microphone jack																																																	
Graphics	Intel HD Graphics or Intel HD Graphics 4400 / 5500 in processor only, or Intel HD Graphics 5500 in processor and AMD Radeon™ R5 M240, 2GB memory (discrete models are only available in Western Europe); supports external analog monitor via VGA and digital monitor via Mini DisplayPort; supports three independent displays; Max resolution: 3840x2160@60Hz (DP via mDP cable); 1920x1200@60Hz (VGA)																																																			
Chipset	Intel SoC (System on Chip) platform																																																			
Memory	16GB max ⁷ / PC3-12800 1600MHz DDR3L, non-parity, dual-channel capable, two 204-pin SO-DIMM sockets																																																			
Display	<i>Some:</i> 14.0" (355mm) HD (1366x768), anti-glare, LED backlight, 220 nits, 16:9 aspect ratio, 500:1 contrast ratio <i>Some:</i> 14.0" (355mm) FHD (1920x1080), anti-glare, LED backlight, 220 nits, 16:9 aspect ratio, 700:1 contrast ratio, IPS																																																			
Multi-touch	None																																																			
Storage	<i>Some:</i> SSD / SATA 6.0Gb/s, 2.5" wide, 7mm high, removable, upgradable <i>Some:</i> HDD / SATA 6.0Gb/s, 2.5" wide, 7mm or 9.5mm high, removable, upgradable, Shock Mounted Hard Drive, Active Protection System™																																																			
M.2 SSD (<i>opt</i>)	<i>Some:</i> SSHD with 8GB NAND flash memory																																																			
Optical	M.2 Solid State Drive (SSD), via M.2 card slot																																																			
Ethernet	<i>Non-vPro model:</i> Intel Ethernet Connection I218-V (Clarkville)																																																			
Bluetooth™	<i>vPro model:</i> Intel Ethernet Connection I218-LM (Clarkville)																																																			
WLAN ⁴	<i>One of the following, configurable by model:</i> <ul style="list-style-type: none"> 11b/g/n, ThinkPad 11b/g/n, 2x2, Wi-Fi + Bluetooth combo adapter, M.2 card 11b/g/n, Intel Wireless-N 7265, 2x2, Wi-Fi + BT, M.2 card (WE only) 11a/b/g/n, Intel Dual Band Wireless-N 7265, 2x2, Wi-Fi + BT, M.2 card (WE only) 11ac, Intel Dual Band Wireless-AC 7265, 2x2, Wi-Fi + BT adapter, M.2 card 																																																			
WWAN (<i>optional</i>)	<i>One of the following, configurable by model:</i> <ul style="list-style-type: none"> Wireless WAN upgradable Wireless WAN, Ericsson® N5321, HSPA+ 21Mbps/GSM/GPRS/EDGE, GPS, M.2 card (WE only) Wireless WAN, Sierra Wireless EM7345, Intel 4G LTE/HSPA/GSM/GPRS/EDGE, GPS, M.2 card 																																																			
SIM card (<i>opt</i>)	AT&T® or Verizon® LTE (4G), contract required with service provider																																																			
		Limited warranty ¹²	<i>One of the following, configurable by model:</i> <ul style="list-style-type: none"> 1-year depot repair service 3-year/1-yr battery depot repair service 3-year/1-yr battery limited onsite service²⁴ 3-year/1-yr battery limited onsite service, OID (Onsite International Delivery) 																																																	
		Mil-Spec test	MIL-STD-810G military certification																																																	
		Environment	EPEAT™ Gold; ENERGY STAR® 6.1; GREENGUARD®; RoHS-compliant																																																	

ThinkPad L450 - TopSeller - 20DT

Product Specifications Reference (PSREF)

Model	Region	Processor	vPro	Graphics	Memory	Display	Multi-touch	Storage	M.2 SSD	Optical	WLAN + Bluetooth	WWAN	SIM Card	Smart Card Reader	Camera	Keyboard	Fingerprint Reader	Battery	Power Adapter	Operating System	Warranty	Ann Date (m/y)
20DT000QUS	US	i5-5200U	No	Intel HD 5500	4GBx1	14" HD (1366x768)	None	500GB 7200rpm	None	None	Intel 7265 ac, 2x2 + BT4.0	WWAN Upgradable	None	None	720p	Non-backlit	Fingerprint Reader	6-cell (48Wh)	45W	Win8.1 DG Win7 Pro 64	1-year, Depot	01/15
20DT000RUS	US	i5-5200U	No	Intel HD 5500	8GBx1	14" HD (1366x768)	None	256GB SSD Opal2	None	None	Intel 7265 ac, 2x2 + BT4.0	WWAN Upgradable	None	None	720p	Non-backlit	Fingerprint Reader	6-cell (48Wh)	45W	Win8.1 DG Win7 Pro 64	1-year, Depot	01/15
20DT000SUS	US	i5-5200U	No	Intel HD 5500	8GBx1	14" HD (1366x768)	None	500GB 7200rpm	None	None	Intel 7265 ac, 2x2 + BT4.0	WWAN Upgradable	None	None	720p	Non-backlit	Fingerprint Reader	6-cell (48Wh)	45W	Win8.1 DG Win7 Pro 64	3-year, Depot	01/15
20DT000TUS	US	i5-5200U	No	Intel HD 5500	8GBx1	14" HD (1366x768)	None	500GB 7200rpm	None	None	Intel 7265 ac, 2x2 + BT4.0	WWAN Upgradable	None	None	720p	Non-backlit	Fingerprint Reader	6-cell (48Wh)	45W	Win8.1 DG Win7 Pro 64	1-year, Depot	01/15
20DT000WUS	US	i3-5005U	No	Intel HD 5500	4GBx1	14" HD (1366x768)	None	500GB 7200rpm	None	None	Intel 7265 ac, 2x2 + BT4.0	WWAN Upgradable	None	None	720p	Non-backlit	Fingerprint Reader	6-cell (48Wh)	45W	Win8.1 DG Win7 Pro 64	1-year, Depot	01/15
20DT000YUS	US	i5-5200U	No	Intel HD 5500	4GBx1	14" HD (1366x768)	None	500GB 7200rpm	None	None	Intel 7265 ac, 2x2 + BT4.0	WWAN Upgradable	None	None	720p	Non-backlit	Fingerprint Reader	6-cell (48Wh)	45W	Win8.1 DG Win7 Pro 64	3-year, Depot	01/15
20DT0010US	US	i5-5200U	No	Intel HD 5500	4GBx1	14" HD (1366x768)	None	256GB SSD Opal2	None	None	Intel 7265 ac, 2x2 + BT4.0	WWAN Upgradable	None	None	720p	Non-backlit	Fingerprint Reader	6-cell (48Wh)	45W	Win8.1 DG Win7 Pro 64	1-year, Depot	01/15
20DT001AUS	US	i5-4300U	vPro	Intel HD 4400	4GBx1	14" HD (1366x768)	None	256GB SSD Opal2	None	None	Intel 7260 ac, 2x2 + BT4.0	WWAN Upgradable	None	None	720p	Non-backlit	Fingerprint Reader	6-cell (48Wh)	45W	Win8.1 DG Win7 Pro 64	1-year, Depot	02/15
20DT001BUS	US	i5-4300U	vPro	Intel HD 4400	8GBx1	14" HD (1366x768)	None	500GB 7200rpm	None	None	Intel 7260 ac, 2x2 + BT4.0	WWAN Upgradable	None	None	720p	Non-backlit	Fingerprint Reader	6-cell (48Wh)	45W	Win8.1 DG Win7 Pro 64	1-year, Depot	02/15
20DT001CUS	US	i5-4300U	vPro	Intel HD 4400	4GBx1	14" HD (1366x768)	None	500GB 7200rpm	None	None	Intel 7260 ac, 2x2 + BT4.0	WWAN Upgradable	None	None	720p	Non-backlit	Fingerprint Reader	6-cell (48Wh)	45W	Win8.1 DG Win7 Pro 64	1-year, Depot	02/15
20DT001DUS	US	i5-4300U	vPro	Intel HD 4400	8GBx1	14" HD (1366x768)	None	256GB SSD Opal2	None	None	Intel 7260 ac, 2x2 + BT4.0	WWAN Upgradable	None	None	720p	Non-backlit	Fingerprint Reader	6-cell (48Wh)	45W	Win8.1 DG Win7 Pro 64	1-year, Depot	02/15
20DT001KUS	US	i5-5200U	No	Intel HD 5500	4GBx1	14" HD (1366x768)	None	500GB 7200rpm	None	None	Intel 7265 ac, 2x2 + BT4.0	WWAN Upgradable	None	None	720p	Non-backlit	Fingerprint Reader	6-cell (48Wh)	45W	Win10 DG Win7 Pro 64	3-year, Depot	08/15
20DT001PUS	US	i3-5005U	No	Intel HD 5500	4GBx1	14" HD (1366x768)	None	500GB 7200rpm	None	None	Intel 7265 ac, 2x2 + BT4.0	WWAN Upgradable	None	None	720p	Non-backlit	Fingerprint Reader	6-cell (48Wh)	45W	Win10 DG Win7 Pro 64	1-year, Depot	08/15
20DT001QUS	US	i5-5200U	No	Intel HD 5500	8GBx1	14" HD (1366x768)	None	256GB SSD Opal2	None	None	Intel 7265 ac, 2x2 + BT4.0	WWAN Upgradable	None	None	720p	Non-backlit	Fingerprint Reader	6-cell (48Wh)	45W	Win10 DG Win7 Pro 64	3-year, Depot	08/15
20DT001SUS	US	i5-5200U	No	Intel HD 5500	8GBx1	14" HD (1366x768)	None	500GB 7200rpm	None	None	Intel 7265 ac, 2x2 + BT4.0	WWAN Upgradable	None	None	720p	Non-backlit	Fingerprint Reader	6-cell (48Wh)	45W	Win10 DG Win7 Pro 64	3-year, Depot	08/15
20DT001VUS	US	i5-5200U	No	Intel HD 5500	8GBx1	14" HD (1366x768)	None	500GB 7200rpm	None	None	Intel 7265 ac, 2x2 + BT4.0	WWAN Upgradable	None	None	720p	Non-backlit	Fingerprint Reader	6-cell (48Wh)	45W	Win10 DG Win7 Pro 64	1-year, Depot	08/15
20DT001WUS	US	i5-5200U	No	Intel HD 5500	4GBx1	14" HD (1366x768)	None	500GB 7200rpm	None	None	Intel 7265 ac, 2x2 + BT4.0	WWAN Upgradable	None	None	720p	Non-backlit	Fingerprint Reader	6-cell (48Wh)	45W	Win10 DG Win7 Pro 64	1-year, Depot	08/15

Model	Region	Processor	vPro	Graphics	Memory	Display	Multi-touch	Storage	M.2 SSD	Optical	WLAN + Bluetooth	WWAN	SIM Card	Smart Card Reader	Camera	Keyboard	Fingerprint Reader	Battery	Power Adapter	Operating System	Warranty	Ann Date (m/y)
20DS000TUS	US	i5-5300U	vPro	Intel HD 5500	4GBx1	14" HD (1366x768)	None	500GB 7200rpm	None	None	Intel 7265 ac, 2x2 + BT4.0	WWAN Upgradable	None	None	720p	Non-backlit	None	6-cell (48Wh)	45W	Win8.1 DG Win7 Pro 64	3-year, Depot	01/15
20DS000UUS	US	i5-5300U	vPro	Intel HD 5500	4GBx1	14" HD (1366x768)	None	128GB SSD	None	None	Intel 7265 ac, 2x2 + BT4.0	WWAN Upgradable	None	None	720p	Non-backlit	Fingerprint Reader	3-cell (23Wh)	45W	Win8.1 DG Win7 Pro 64	3-year, Onsite	01/15
20DS000VUS	US	i5-5200U	No	Intel HD 5500	4GBx1	14" HD (1366x768)	None	128GB SSD	None	None	Intel 7265 ac, 2x2 + BT4.0	WWAN Upgradable	None	None	720p	Non-backlit	None	6-cell (48Wh)	45W	Win8.1 DG Win7 Pro 64	3-year, Depot	01/15
20DS000WUS	US	i5-5300U	vPro	Intel HD 5500	8GBx1	14" FHD (1920x1080) IPS	None	500GB 7200rpm	None	None	Intel 7265 ac, 2x2 + BT4.0	WWAN Upgradable	None	None	720p	Non-backlit	Fingerprint Reader	6-cell (48Wh)	45W	Win8.1 DG Win7 Pro 64	3-year, Onsite	01/15
20DS000XUS	US	i5-5200U	No	Intel HD 5500	8GBx1	14" HD (1366x768)	None	128GB SSD	None	None	Intel 7265 ac, 2x2 + BT4.0	WWAN Upgradable	None	None	720p	Non-backlit	None	6-cell (48Wh)	45W	Win8.1 DG Win7 Pro 64	3-year, Onsite	01/15
20DS000YUS	US	i5-5200U	No	Intel HD 5500	4GBx1	14" HD (1366x768)	None	128GB SSD	None	None	Intel 7265 ac, 2x2 + BT4.0	WWAN Upgradable	None	None	720p	Non-backlit	None	6-cell (48Wh)	45W	Win8.1 DG Win7 Pro 64	3-year, Onsite	01/15
20DS0010US	US	i5-5300U	vPro	Intel HD 5500	4GBx1	14" FHD (1920x1080) IPS	None	500GB 7200rpm	None	None	Intel 7265 ac, 2x2 + BT4.0	WWAN Upgradable	None	None	720p	Non-backlit	Fingerprint Reader	6-cell (48Wh)	45W	Win8.1 DG Win7 Pro 64	3-year, Onsite	01/15
20DS0011US	US	i5-5300U	vPro	Intel HD 5500	4GBx1	14" FHD (1920x1080) IPS	None	128GB SSD	None	None	Intel 7265 ac, 2x2 + BT4.0	WWAN Upgradable	None	None	720p	Non-backlit	Fingerprint Reader	3-cell (23Wh)	45W	Win8.1 DG Win7 Pro 64	3-year, Depot	01/15
20DS0012US	US	i5-5300U	vPro	Intel HD 5500	4GBx1	14" FHD (1920x1080) IPS	None	500GB 7200rpm	None	None	Intel 7265 ac, 2x2 + BT4.0	WWAN Upgradable	None	None	720p	Non-backlit	Fingerprint Reader	3-cell (23Wh)	45W	Win8.1 DG Win7 Pro 64	3-year, Depot	01/15
20DS0013US	US	i5-5300U	vPro	Intel HD 5500	4GBx1	14" FHD (1920x1080) IPS	None	500GB 7200rpm	None	None	Intel 7265 ac, 2x2 + BT4.0	WWAN Upgradable	None	None	720p	Non-backlit	Fingerprint Reader	6-cell (48Wh)	45W	Win8.1 DG Win7 Pro 64	3-year, Depot	01/15
20DS0014US	US	i5-5300U	vPro	Intel HD 5500	8GBx1	14" FHD (1920x1080) IPS	None	500GB 7200rpm	None	None	Intel 7265 ac, 2x2 + BT4.0	WWAN Upgradable	None	None	720p	Non-backlit	Fingerprint Reader	3-cell (23Wh)	45W	Win8.1 DG Win7 Pro 64	3-year, Depot	01/15
20DS0015US	US	i5-5300U	vPro	Intel HD 5500	8GBx1	14" HD (1366x768)	None	500GB 7200rpm	None	None	Intel 7265 ac, 2x2 + BT4.0	WWAN Upgradable	None	None	720p	Non-backlit	Fingerprint Reader	6-cell (48Wh)	45W	Win8.1 DG Win7 Pro 64	3-year, Onsite	01/15
20DS0016US	US	i5-5300U	vPro	Intel HD 5500	4GBx1	14" HD (1366x768)	None	256GB SSD Opal2	None	None	Intel 7265 ac, 2x2 + BT4.0	WWAN Upgradable	None	None	720p	Non-backlit	None	6-cell (48Wh)	45W	Win8.1 DG Win7 Pro 64	3-year, Depot	01/15
20DS0017US	US	i5-5200U	No	Intel HD 5500	8GBx1	14" HD (1366x768)	None	500GB 7200rpm	None	None	Intel 7265 ac, 2x2 + BT4.0	WWAN Upgradable	None	None	720p	Non-backlit	None	6-cell (48Wh)	45W	Win8.1 DG Win7 Pro 64	3-year, Onsite	01/15
20DS0018US	US	i5-5300U	vPro	Intel HD 5500	8GBx1	14" HD (1366x768)	None	500GB 7200rpm	None	None	Intel 7265 ac, 2x2 + BT4.0	WWAN Upgradable	None	None	720p	Non-backlit	None	6-cell (48Wh)	45W	Win8.1 DG Win7 Pro 64	3-year, Depot	01/15
20DS0019US	US	i5-5200U	No	Intel HD 5500	8GBx1	14" HD (1366x768)	None	128GB SSD	None	None	Intel 7265 ac, 2x2 + BT4.0	WWAN Upgradable	None	None	720p	Non-backlit	None	6-cell (48Wh)	45W	Win8.1 DG Win7 Pro 64	3-year, Depot	01/15
20DS001AUS	US	i5-5300U	vPro	Intel HD 5500	8GBx1	14" FHD (1920x1080) IPS	None	500GB 7200rpm	None	None	Intel 7265 ac, 2x2 + BT4.0	WWAN Upgradable	None	None	720p	Non-backlit	Fingerprint Reader	6-cell (48Wh)	45W	Win8.1 DG Win7 Pro 64	3-year, Depot	01/15
20DS001BUS	US	i5-5300U	vPro	Intel HD 5500	8GBx1	14" HD (1366x768)	None	128GB SSD	None	None	Intel 7265 ac, 2x2 + BT4.0	WWAN Upgradable	None	None	720p	Non-backlit	Fingerprint Reader	3-cell (23Wh)	45W	Win8.1 DG Win7 Pro 64	3-year, Onsite	01/15
20DS001CUS	US	i5-5300U	vPro	Intel HD 5500	8GBx1	14" HD (1366x768)	None	256GB SSD Opal2	None	None	Intel 7265 ac, 2x2 + BT4.0	WWAN Upgradable	None	None	720p	Non-backlit	None	6-cell (48Wh)	45W	Win8.1 DG Win7 Pro 64	3-year, Depot	01/15
20DS001DUS	US	i5-5300U	vPro	Intel HD 5500	4GBx1	14" HD (1366x768)	None	128GB SSD	None	None	Intel 7265 ac, 2x2 + BT4.0	WWAN Upgradable	None	None	720p	Non-backlit	None	3-cell (23Wh)	45W	Win8.1 DG Win7 Pro 64	3-year, Depot	01/15

Model	Region	Processor	vPro	Graphics	Memory	Display	Multi-touch	Storage	M.2 SSD	Optical	WLAN + Bluetooth	WWAN	SIM Card	Smart Card Reader	Camera	Keyboard	Fingerprint Reader	Battery	Power Adapter	Operating System	Warranty	Ann Date (m/y)
20DS001EUS	US	i5-5300U	vPro	Intel HD 5500	8GBx1	14" HD (1366x768)	None	256GB SSD Opal2	None	None	Intel 7265 ac, 2x2 + BT4.0	WWAN Upgradable	None	None	720p	Non-backlit	None	6-cell (48Wh)	45W	Win8.1 DG Win7 Pro 64	3-year, Onsite	01/15
20DS001FUS	US	i5-5300U	vPro	Intel HD 5500	4GBx1	14" HD (1366x768)	None	500GB 7200rpm	None	None	Intel 7265 ac, 2x2 + BT4.0	WWAN Upgradable	None	None	720p	Non-backlit	None	6-cell (48Wh)	45W	Win8.1 DG Win7 Pro 64	3-year, Onsite	01/15
20DS001GUS	US	i5-5300U	vPro	Intel HD 5500	8GBx1	14" HD (1366x768)	None	128GB SSD	None	None	Intel 7265 ac, 2x2 + BT4.0	WWAN Upgradable	None	None	720p	Non-backlit	None	3-cell (23Wh)	45W	Win8.1 DG Win7 Pro 64	3-year, Depot	01/15
20DS001HUS	US	i5-5200U	No	Intel HD 5500	4GBx1	14" HD (1366x768)	None	500GB 7200rpm	None	None	Intel 7265 ac, 2x2 + BT4.0	WWAN Upgradable	None	None	720p	Non-backlit	None	6-cell (48Wh)	45W	Win8.1 DG Win7 Pro 64	3-year, Depot	01/15
20DS001JUS	US	i5-5200U	No	Intel HD 5500	4GBx1	14" HD (1366x768)	None	500GB 7200rpm	None	None	Intel 7265 ac, 2x2 + BT4.0	WWAN Upgradable	None	None	720p	Non-backlit	None	6-cell (48Wh)	45W	Win8.1 DG Win7 Pro 64	3-year, Onsite	01/15
20DS001KUS	US	i5-5300U	vPro	Intel HD 5500	4GBx1	14" HD (1366x768)	None	256GB SSD Opal2	None	None	Intel 7265 ac, 2x2 + BT4.0	WWAN Upgradable	None	None	720p	Non-backlit	None	6-cell (48Wh)	45W	Win8.1 DG Win7 Pro 64	3-year, Onsite	01/15
20DS001LUS	US	i5-5300U	vPro	Intel HD 5500	4GBx1	14" FHD (1920x1080) IPS	None	500GB 7200rpm	None	None	Intel 7265 ac, 2x2 + BT4.0	WWAN Upgradable	None	None	720p	Non-backlit	Fingerprint Reader	3-cell (23Wh)	45W	Win8.1 DG Win7 Pro 64	3-year, Onsite	01/15
20DS001MUS	US	i5-5200U	No	Intel HD 5500	4GBx2	14" HD (1366x768)	None	500GB 7200rpm	None	None	Intel 7265 ac, 2x2 + BT4.0	WWAN Upgradable	None	None	720p	Non-backlit	None	6-cell (48Wh)	45W	Win8.1 DG Win7 Pro 64	3-year, Depot	01/15
20DS001NUS	US	i5-5300U	vPro	Intel HD 5500	8GBx1	14" FHD (1920x1080) IPS	None	500GB 7200rpm	None	None	Intel 7265 ac, 2x2 + BT4.0	WWAN Upgradable	None	None	720p	Non-backlit	Fingerprint Reader	3-cell (23Wh)	45W	Win8.1 DG Win7 Pro 64	3-year, Onsite	01/15
20DS001SUS	US	i5-4300U	vPro	Intel HD 4400	4GBx1	14" FHD (1920x1080) IPS	None	256GB SSD Opal2	None	None	Intel 7260 ac, 2x2 + BT4.0	WWAN Upgradable	None	None	720p	Non-backlit	None	6-cell (48Wh)	45W	Win8.1 DG Win7 Pro 64	3-year, Depot	01/15
20DS001UUS	US	i5-4300U	vPro	Intel HD 4400	4GBx1	14" FHD (1920x1080) IPS	None	500GB 7200rpm	None	None	Intel 7260 ac, 2x2 + BT4.0	WWAN Upgradable	None	None	720p	Non-backlit	Fingerprint Reader	6-cell (48Wh)	45W	Win8.1 DG Win7 Pro 64	3-year, Depot	01/15
20DS001WUS	US	i5-4300U	vPro	Intel HD 4400	8GBx1	14" HD (1366x768)	None	128GB SSD	None	None	Intel 7260 ac, 2x2 + BT4.0	WWAN Upgradable	None	None	720p	Non-backlit	Fingerprint Reader	6-cell (48Wh)	45W	Win8.1 DG Win7 Pro 64	3-year, Depot	01/15
20DS001XUS	US	i5-4300U	vPro	Intel HD 4400	4GBx1	14" HD (1366x768)	None	128GB SSD	None	None	Intel 7260 ac, 2x2 + BT4.0	WWAN Upgradable	None	None	720p	Non-backlit	Fingerprint Reader	6-cell (48Wh)	45W	Win8.1 DG Win7 Pro 64	3-year, Depot	01/15
20DS001YUS	US	i5-4300U	vPro	Intel HD 4400	4GBx1	14" HD (1366x768)	None	256GB SSD Opal2	None	None	Intel 7260 ac, 2x2 + BT4.0	WWAN Upgradable	None	None	720p	Non-backlit	Fingerprint Reader	6-cell (48Wh)	45W	Win8.1 DG Win7 Pro 64	3-year, Depot	01/15
20DS0020US	US	i5-4300U	vPro	Intel HD 4400	8GBx1	14" FHD (1920x1080) IPS	None	256GB SSD Opal2	None	None	Intel 7260 ac, 2x2 + BT4.0	WWAN Upgradable	None	None	720p	Non-backlit	Fingerprint Reader	6-cell (48Wh)	45W	Win8.1 DG Win7 Pro 64	3-year, Depot	01/15
20DS0021US	US	i5-4300U	vPro	Intel HD 4400	4GBx1	14" HD (1366x768)	None	256GB SSD Opal2	None	None	Intel 7260 ac, 2x2 + BT4.0	WWAN Upgradable	None	None	720p	Non-backlit	None	6-cell (48Wh)	45W	Win8.1 DG Win7 Pro 64	3-year, Depot	01/15
20DS0022US	US	i5-4300U	vPro	Intel HD 4400	4GBx1	14" FHD (1920x1080) IPS	None	256GB SSD Opal2	None	None	Intel 7260 ac, 2x2 + BT4.0	WWAN Upgradable	None	None	720p	Non-backlit	Fingerprint Reader	6-cell (48Wh)	45W	Win8.1 DG Win7 Pro 64	3-year, Depot	01/15
20DS0023US	US	i5-4300U	vPro	Intel HD 4400	4GBx1	14" FHD (1920x1080) IPS	None	500GB 7200rpm	None	None	Intel 7260 ac, 2x2 + BT4.0	WWAN Upgradable	None	None	720p	Non-backlit	None	6-cell (48Wh)	45W	Win8.1 DG Win7 Pro 64	3-year, Depot	01/15
20DS0024US	US	i5-4300U	vPro	Intel HD 4400	8GBx1	14" HD (1366x768)	None	256GB SSD Opal2	None	None	Intel 7260 ac, 2x2 + BT4.0	WWAN Upgradable	None	None	720p	Non-backlit	Fingerprint Reader	6-cell (48Wh)	45W	Win8.1 DG Win7 Pro 64	3-year, Depot	01/15
20DS0025US	US	i5-4300U	vPro	Intel HD 4400	8GBx1	14" FHD (1920x1080) IPS	None	500GB 7200rpm	None	None	Intel 7260 ac, 2x2 + BT4.0	WWAN Upgradable	None	None	720p	Non-backlit	Fingerprint Reader	6-cell (48Wh)	45W	Win8.1 DG Win7 Pro 64	3-year, Depot	01/15

Model	Region	Processor	vPro	Graphics	Memory	Display	Multi-touch	Storage	M.2 SSD	Optical	WLAN + Bluetooth	WWAN	SIM Card	Smart Card Reader	Camera	Keyboard	Fingerprint Reader	Battery	Power Adapter	Operating System	Warranty	Ann Date (m/y)
20DS0026US	US	i5-4300U	vPro	Intel HD 4400	4GBx1	14" HD (1366x768)	None	128GB SSD	None	None	Intel 7260 ac, 2x2 + BT4.0	WWAN Upgradable	None	None	720p	Non-backlit	None	6-cell (48Wh)	45W	Win8.1 DG Win7 Pro 64	3-year, Depot	01/15



ThinkPad L460 Platform Specifications

Product Specifications Reference (PSREF)

Processor	Intel® Celeron® processor or 6th Generation Intel Core™ i3 / i5 / i7 Processor							Dimensions ³ Weight ²	WxDxH: 13.34" x 9.23" x 0.95"; 339mm x 235mm x 24.3mm					
	Processor Number	# of Cores	# of Threads	Base Frequency	Max Turbo Frequency	Cache	Memory Types		Processor Graphics	Models	3-cell		6-cell	
	Cel 3855U	2	4	1.6 GHz	-	2MB	DDR3L-1600	Intel HD Graphics 510	Integrated model	4.25 lb / 1.93 kg		4.45 lb / 2.02 kg		
	i3-6006U			2.0 GHz	-	3MB		Intel HD Graphics 520		discrete model	4.3 lb / 1.95 kg		4.5 lb / 2.04 kg	
	i3-6100U			2.3 GHz	-	3MB								
	i5-6200U			2.3 GHz	2.8 GHz	3MB								
	i5-6300U			2.4 GHz	3.0 GHz	3MB								
	i7-6500U			2.5 GHz	3.1 GHz	4MB								
	i7-6600U			2.6 GHz	3.4 GHz	4MB								
Graphics	Intel HD Graphics 510 or 520 in processor only, or Intel HD Graphics 520 in processor and AMD Exo Pro Radeon R5, 2GB memory; supports external analog monitor via VGA and digital monitor via Mini DisplayPort; supports three independent displays; Max resolution: 3840x2160@60Hz (DP via mDP cable); 1920x1200@60Hz (VGA)							Case material	PolyCarbonate/Acrylonitrile-Butadiene-Styrene (PC/ABS) plastic					
Chipset	Intel SoC (System on Chip) platform							Smart card reader	Optional: Smart card reader					
Memory	32GB max ⁷ / PC3-12800 1600MHz DDR3L, non-parity, dual-channel capable, two DDR3L SO-DIMM sockets							Media reader	4-in-1 reader (MMC, SD, SDHC, SDXC)					
Display	Some: 14.0" (355mm) HD (1366x768), anti-glare, LED backlight, 220 nits, 16:9 aspect ratio, 400:1 or 500:1 contrast ratio Some: 14.0" (355mm) FHD (1920x1080), anti-glare, LED backlight, IPS, 250 nits, 16:9 aspect ratio, 600:1 or 700:1 contrast ratio, 170° viewing angle							Ports	Three USB 3.0 (one Always On), VGA, Mini DisplayPort, Ethernet (RJ-45), Dock connector (integrated models only)					
Multi-touch	None							Camera (optional)	HD720p resolution, low light sensitive, fixed focus					
Storage	Some: SSD / SATA 6.0Gb/s, 2.5" wide, 7mm high Some: HDD / SATA 6.0Gb/s, 2.5" wide, 7mm or 9.5mm high, Shock Mounted Hard Drive, Active Protection System™ Some: SSHD with 8GB NAND flash memory							Audio support	HD Audio, Realtek® ALC3245 codec / stereo speakers, 2W x 2 / dual array microphone, combo audio/microphone jack					
Optical	None							Keyboard	6-row, spill-resistant, multimedia Fn keys					
Ethernet	Non-vPro model: Intel Ethernet Connection I219-V (Jacksonville) vPro model: Intel Ethernet Connection I219-LM (Jacksonville)							UltraNav™	TrackPoint® pointing device and buttonless Mylar surface multi-touch touchpad					
WLAN ⁴	One of the following, configurable by model: • 11ac+BT, Broadcom BCM4356, 2x2, M.2 card • 11ac+BT, Intel Dual Band Wireless-AC 8260, 2x2, M.2 card							Security	Power-on password, hard disk password, supervisor password, security keyhole					
Bluetooth™	Bluetooth 4.1 wireless, integrated in Wi-Fi + Bluetooth combo adapter							Security chip	Discrete TPM 1.2 TCG Certified and Firmware TPM 2.0 integrated in chipset					
WWAN (optional)	One of the following, configurable by model: • Wireless WAN upgradable • Wireless WAN, Sierra Wireless EM7455, Qualcomm® 4G LTE-Advanced/DC-HSPA+/HSPA+/HSPA/UMTS/GNSS, M.2 card • Wireless WAN, HUAWEI ME906S, HUAWEI 4G LTE/WCDMA/HSPA/GSM/GPRS/EDGE/GNSS, M.2 card (WE only)							ThinkEngine	Delivers improved thermal and power efficiency, up to 30 day standby, faster resume time, enhanced security, as well as anti-tampering measures					
SIM card (opt)	Micro-SIM card slot, optional Verizon LTE (US) or Lenovo Connect (WE) SIM card							vPro (optional)	Intel vPro Technology					
							Fingerprint reader	Optional: Swipe style fingerprint reader on the keyboard bezel						
							Battery	Li-Ion 3-cell (23Wh) or 6-cell (48Wh or 72Wh)						
							Max battery life ¹⁰ (MobileMark® 2014)	Models	3-cell	6-cell 48Wh		6-cell 72Wh		
								Max battery life	6.93 hr		12.7 hr		20.53 hr	
							AC adapter	45W or 65W AC adapter						
							Preload	Windows 7 Professional 64 preinstalled through downgrade rights in Windows 10 Pro 64	Windows 10 Pro 64					
								• Lenovo Solution Center	• Lenovo Solution Center					
								• ThinkVantage Product Recovery	• Lenovo Companion					
								• Rescue and Recovery™	• Lenovo Setting					
								• ThinkVantage System Update	• Microsoft Office preloaded; purchase a product key to activate					
								• Adobe® Reader®	• McAfee® LiveSafe™ (30-day trial)					
								• Microsoft® Office preloaded; purchase a product key to activate						
								• McAfee® LiveSafe™ (30-day trial)						
							Limited warranty ¹²	One of the following, configurable by model:						
								• 1-year depot repair service						
								• 3-year/1-yr battery depot repair service						
								• 3-year/1-yr battery limited onsite service ²⁴						
								• 3-year/1-yr battery limited onsite service, OID (Onsite International Delivery)						
							Mil-Spec test	MIL-STD-810G military certification						
							Environment	EPEAT™ Gold (US only); ENERGY STAR® 6.1; GREENGUARD®; RoHS-compliant						

Model	Region	Processor	vPro	Graphics	Memory	Display	Multi-touch	Storage	Optical	WLAN + Bluetooth	WWAN	SIM Card	Smart Card Reader	Camera	Keyboard	Fingerprint Reader	Battery	Power Adapter	Operating System	Warranty	Ann Date (m/y)
20FU0014US	US	i5-6200U	No	Intel HD 520	8GBx1	14" HD (1366x768)	None	256GB SSD Opal2	None	Intel 8260 ac, 2x2 + BT4.1	WWAN Upgradable	None	None	720p	Non-backlit	None	6-cell (48Wh)	45W	Win10 DG Win7 Pro 64	3-year, Depot	01/16
20FU0015US	US	i5-6200U	No	Intel HD 520	8GBx1	14" FHD (1920x1080) IPS	None	256GB SSD Opal2	None	Intel 8260 ac, 2x2 + BT4.1	WWAN Upgradable	None	None	720p	Non-backlit	Fingerprint Reader	6-cell (48Wh)	45W	Win10 DG Win7 Pro 64	1-year, Depot	01/16
20FU0017US	US	i3-6100U	No	Intel HD 520	4GBx1	14" HD (1366x768)	None	192GB SSD	None	Intel 8260 ac, 2x2 + BT4.1	WWAN Upgradable	None	None	720p	Non-backlit	None	6-cell (48Wh)	45W	Win10 DG Win7 Pro 64	1-year, Depot	01/16
20FU0018US	US	i5-6200U	No	Intel HD 520	4GBx1	14" HD (1366x768)	None	192GB SSD	None	Intel 8260 ac, 2x2 + BT4.1	WWAN Upgradable	None	None	720p	Non-backlit	None	6-cell (48Wh)	45W	Win10 Pro 64	1-year, Depot	01/16
20FU001BUS	US	i5-6200U	No	Intel HD 520	8GBx1	14" HD (1366x768)	None	256GB SSD Opal2	None	Intel 8260 ac, 2x2 + BT4.1	WWAN Upgradable	None	None	720p	Non-backlit	None	6-cell (48Wh)	45W	Win10 Pro 64	3-year, Depot	01/16
20FU001CUS	US	i5-6200U	No	Intel HD 520	8GBx1	14" FHD (1920x1080) IPS	None	256GB SSD Opal2	None	Intel 8260 ac, 2x2 + BT4.1	WWAN Upgradable	None	None	720p	Non-backlit	Fingerprint Reader	6-cell (48Wh)	45W	Win10 Pro 64	1-year, Depot	01/16
20FU001DUS	US	i5-6200U	No	Intel HD 520	4GBx1	14" HD (1366x768)	None	192GB SSD	None	Intel 8260 ac, 2x2 + BT4.1	WWAN Upgradable	None	None	720p	Non-backlit	None	6-cell (48Wh)	45W	Win10 DG Win7 Pro 64	1-year, Depot	01/16
20FU001EUS	US	i3-6100U	No	Intel HD 520	4GBx1	14" HD (1366x768)	None	500GB 7200rpm	None	Intel 8260 ac, 2x2 + BT4.1	WWAN Upgradable	None	None	720p	Non-backlit	None	6-cell (48Wh)	45W	Win10 Pro 64	1-year, Depot	01/16
20FU001GUS	US	i3-6100U	No	Intel HD 520	4GBx1	14" HD (1366x768)	None	192GB SSD	None	Intel 8260 ac, 2x2 + BT4.1	WWAN Upgradable	None	None	720p	Non-backlit	None	6-cell (48Wh)	45W	Win10 Pro 64	1-year, Depot	01/16
20FU001HUS	US	i3-6100U	No	Intel HD 520	4GBx1	14" HD (1366x768)	None	500GB 7200rpm	None	Intel 8260 ac, 2x2 + BT4.1	WWAN Upgradable	None	None	720p	Non-backlit	None	6-cell (48Wh)	45W	Win10 DG Win7 Pro 64	1-year, Depot	01/16
20FU0024US	US	i5-6300U	vPro	Intel HD 520	8GBx1	14" FHD (1920x1080) IPS	None	256GB SSD Opal2	None	Intel 8260 ac, 2x2 + BT4.1	WWAN Upgradable	None	None	720p	Non-backlit	Fingerprint Reader	6-cell (48Wh)	45W	Win10 Pro 64	1-year, Depot	01/16
20FU0025US	US	i5-6300U	vPro	Intel HD 520	8GBx1	14" FHD (1920x1080) IPS	None	256GB SSD Opal2	None	Intel 8260 ac, 2x2 + BT4.1	WWAN Upgradable	None	None	720p	Non-backlit	Fingerprint Reader	6-cell (48Wh)	45W	Win10 DG Win7 Pro 64	1-year, Depot	01/16
20FU0026US	US	i5-6300U	vPro	Intel HD 520	4GBx1	14" HD (1366x768)	None	500GB 7200rpm	None	Intel 8260 ac, 2x2 + BT4.1	WWAN Upgradable	None	None	720p	Non-backlit	None	6-cell (48Wh)	45W	Win10 DG Win7 Pro 64	1-year, Depot	01/16
20FU0027US	US	i5-6300U	vPro	Intel HD 520	4GBx1	14" HD (1366x768)	None	500GB 7200rpm	None	Intel 8260 ac, 2x2 + BT4.1	WWAN Upgradable	None	None	720p	Non-backlit	None	6-cell (48Wh)	45W	Win10 Pro 64	1-year, Depot	01/16
20FU0028US	US	i5-6300U	vPro	Intel HD 520	4GBx1	14" HD (1366x768)	None	192GB SSD	None	Intel 8260 ac, 2x2 + BT4.1	WWAN Upgradable	None	None	720p	Non-backlit	Fingerprint Reader	6-cell (48Wh)	45W	Win10 DG Win7 Pro 64	3-year, Depot	02/16
20FU0029US	US	i5-6200U	No	AMD Exo Pro R5 2GB	4GBx1	14" HD (1366x768)	None	500GB 7200rpm	None	Intel 8260 ac, 2x2 + BT4.1	WWAN Upgradable	None	None	720p	Non-backlit	None	6-cell (48Wh)	65W	Win10 Pro 64	1-year, Depot	02/16
20FU002AUS	US	i5-6200U	No	Intel HD 520	4GBx1	14" HD (1366x768)	None	500GB 7200rpm	None	Intel 8260 ac, 2x2 + BT4.1	WWAN Upgradable	None	None	720p	Non-backlit	None	6-cell (48Wh)	45W	Win10 DG Win7 Pro 64	1-year, Depot	02/16
20FU002BUS	US	i5-6300U	vPro	Intel HD 520	4GBx1	14" HD (1366x768)	None	192GB SSD	None	Intel 8260 ac, 2x2 + BT4.1	WWAN Upgradable	None	None	720p	Non-backlit	Fingerprint Reader	6-cell (48Wh)	45W	Win10 Pro 64	3-year, Depot	02/16
20FU003PUS	US	i3-6100U	No	Intel HD 520	4GBx1	14" HD (1366x768)	None	256GB SSD Opal2	None	Intel 8260 ac, 2x2 + BT4.1	WWAN Upgradable	None	None	720p	Non-backlit	None	6-cell (48Wh)	45W	Win10 Pro 64	1-year, Depot	10/16
20FU003QUS	US	i5-6300U	vPro	Intel HD 520	4GBx1	14" HD (1366x768)	None	256GB SSD Opal2	None	Intel 8260 ac, 2x2 + BT4.1	WWAN Upgradable	None	None	720p	Non-backlit	Fingerprint Reader	6-cell (48Wh)	45W	Win10 DG Win7 Pro 64	3-year, Depot	10/16

Model	Region	Processor	vPro	Graphics	Memory	Display	Multi-touch	Storage	Optical	WLAN + Bluetooth	WWAN	SIM Card	Smart Card Reader	Camera	Keyboard	Fingerprint Reader	Battery	Power Adapter	Operating System	Warranty	Ann Date (m/y)
20FU003RUS	US	i5-6200U	No	Intel HD 520	4GBx1	14" HD (1366x768)	None	256GB SSD Opal2	None	Intel 8260 ac, 2x2 + BT4.1	WWAN Upgradable	None	None	720p	Non-backlit	None	6-cell (48Wh)	45W	Win10 DG Win7 Pro 64	1-year, Depot	10/16
20FU003SUS	US	i5-6200U	No	Intel HD 520	4GBx1	14" HD (1366x768)	None	256GB SSD Opal2	None	Intel 8260 ac, 2x2 + BT4.1	WWAN Upgradable	None	None	720p	Non-backlit	None	6-cell (48Wh)	45W	Win10 Pro 64	1-year, Depot	10/16
20FU003TUS	US	i5-6300U	vPro	Intel HD 520	4GBx1	14" HD (1366x768)	None	256GB SSD Opal2	None	Intel 8260 ac, 2x2 + BT4.1	WWAN Upgradable	None	None	720p	Non-backlit	Fingerprint Reader	6-cell (48Wh)	45W	Win10 Pro 64	3-year, Depot	10/16
20FU003UUS	US	i3-6100U	No	Intel HD 520	4GBx1	14" HD (1366x768)	None	256GB SSD Opal2	None	Intel 8260 ac, 2x2 + BT4.1	WWAN Upgradable	None	None	720p	Non-backlit	None	6-cell (48Wh)	45W	Win10 DG Win7 Pro 64	1-year, Depot	10/16
20FU004GUS	US	i5-6200U	No	Intel HD 520	4GBx1	14" HD (1366x768)	None	180GB SSD Opal2	None	Intel 8260 ac, 2x2 + BT4.1	WWAN Upgradable	None	None	720p	Non-backlit	None	6-cell (48Wh)	45W	Win10 Pro 64	1-year, Depot	11/16
20FU004HUS	US	i5-6300U	vPro	Intel HD 520	4GBx1	14" HD (1366x768)	None	180GB SSD Opal2	None	Intel 8260 ac, 2x2 + BT4.1	WWAN Upgradable	None	None	720p	Non-backlit	Fingerprint Reader	6-cell (48Wh)	45W	Win10 DG Win7 Pro 64	3-year, Depot	11/16
20FU004JUS	US	i5-6200U	No	Intel HD 520	4GBx1	14" HD (1366x768)	None	180GB SSD Opal2	None	Intel 8260 ac, 2x2 + BT4.1	WWAN Upgradable	None	None	720p	Non-backlit	None	6-cell (48Wh)	45W	Win10 DG Win7 Pro 64	1-year, Depot	11/16
20FU004LUS	US	i5-6300U	vPro	Intel HD 520	4GBx1	14" HD (1366x768)	None	180GB SSD Opal2	None	Intel 8260 ac, 2x2 + BT4.1	WWAN Upgradable	None	None	720p	Non-backlit	Fingerprint Reader	6-cell (48Wh)	45W	Win10 Pro 64	3-year, Depot	11/16



ThinkPad L470 Platform Specifications

Product Specifications Reference (PSREF)

Processor	Intel® Celeron® processor or 7th Generation Intel Core™ i3 / i5 / i7 Processor								Dimensions Weight	<i>WxDxH:</i> 13.35" x 9.25" x 0.94"; 339mm x 235mm x 23.9mm							
	Processor Number	# of Cores	# of Threads	Base Frequency	Max Turbo Frequency	Cache	Memory Types	Processor Graphics		<i>Models</i>	<i>3-cell</i>		<i>6-cell</i>				
	Cel 3965U	2	4	2.2 GHz	-	2MB	DDR4-2133	Intel HD Graphics 610		<i>Integrated model</i>	4.13 lb / 1.87 kg		4.45 lb / 2.02 kg				
	i3-7100U			2.4 GHz	-	3MB		Intel HD Graphics 620		<i>discrete model</i>	4.16 lb / 1.89 kg		4.48 lb / 2.03 kg				
	i5-7200U			2.5 GHz	3.1 GHz	3MB											
	i5-7300U			2.6 GHz	3.5 GHz	3MB											
	i7-7500U			2.7 GHz	3.5 GHz	4MB											
i7-7600U	2.8 GHz			3.9 GHz	4MB												
Case color	Black																
Case material	PC/ABS plastic																
Smart card reader	<i>Optional:</i> Smart card reader																
Media reader	4-in-1 reader (MMC, SD, SDHC, SDXC)																
Ports	Three USB 3.1 Gen 1 / USB 3.0 (one Always On), VGA, Mini DisplayPort, Ethernet (RJ-45), Dock connector																
Graphics	Intel HD Graphics 610 or 620 in processor only, or Intel HD Graphics 620 in processor and AMD Radeon™ R5 M430, 2GB memory; supports external analog monitor via VGA and digital monitor via Mini DisplayPort; supports three independent displays; Max resolution: 3840x2160@60Hz (DP via mDP cable); 1920x1200@60Hz (VGA)								Camera (<i>optional</i>)	HD720p resolution, fixed focus							
Chipset	Intel SoC (System on Chip) platform								Audio support	HD Audio, Realtek ALC3268 codec / stereo speakers, 1W x 2 / dual array microphone, combo audio/microphone jack							
Memory	32GB max / 2400MHz DDR4, dual-channel capable, two DDR4 SO-DIMM sockets * System clocks down for processors with lower memory controller								Keyboard	6-row, spill-resistant, multimedia Fn keys							
Display	<i>Some:</i> 14.0" (355mm) HD (1366x768), anti-glare, LED backlight, 220 nits, 16:9 aspect ratio, 500:1 contrast ratio <i>Some:</i> 14.0" (355mm) FHD (1920x1080), anti-glare, LED backlight, IPS, 250 nits, 16:9 aspect ratio, 700:1 contrast ratio, 170° viewing angle								UltraNav™	TrackPoint® pointing device and buttonless Mylar surface multi-touch touchpad							
Multi-touch	None								Security	Power-on password, hard disk password, supervisor password, security keyhole							
Storage	<i>System has one HDD slot or one M.2 2280 slot exclusively for storage</i> <i>Some:</i> HDD / SATA 6.0Gb/s, 2.5" wide, 7mm or 9.5mm high, Active Protection System™ <i>Some:</i> SSD / SATA 6.0Gb/s, 2.5" wide, 7mm high (e.g. xxxGB SSD) <i>Some:</i> M.2 SSD / PCIe NVMe, PCIe 3.0 x 2, 16Gb/s <i>Some:</i> 128GB M.2 SSD / SATA 6.0Gb/s, in WWAN slot as 2nd Storage <i>Some:</i> 16GB Intel Optane™ memory, PCIe NVMe, PCIe 3.0 x 2, 16Gb/s, in WWAN slot as storage cache for HDD								Security chip	<i>Win7 model:</i> discrete TPM 1.2, TCG Certified <i>Win10 model:</i> discrete TPM 2.0, TCG Certified							
Ethernet	<i>Non-vPro model:</i> Intel Ethernet Connection I219-V (Jacksonville) <i>vPro model:</i> Intel Ethernet Connection I219-LM (Jacksonville)								vPro (<i>optional</i>)	Intel vPro Technology							
WLAN	<i>One of the following, configurable by model:</i> • Realtek® RTL8822BE, Wi-Fi 2x2 802.11ac + BT4.1, M.2 card • Intel Dual Band Wireless-AC 8260, Wi-Fi 2x2 802.11ac + BT4.1, M.2 card • Intel Dual Band Wireless-AC 8265, Wi-Fi 2x2 802.11ac + BT4.1, M.2 card Bluetooth™ * Intel 8265ac card supports BT4.2 but is limited to BT4.1 by Windows OS								Fingerprint reader	<i>Optional:</i> Swipe style fingerprint reader on the keyboard bezel							
Bluetooth™	* Intel 8265ac card supports BT4.2 but is limited to BT4.1 by Windows OS								NFC	None							
WWAN (<i>optional</i>)	<i>One of the following, configurable by model:</i> • Wireless WAN upgradable • Integrated Mobile Broadband 4G LTE-A, Qualcomm® Snapdragon™ X7 LTE-A (Sierra Wireless EM7455), M.2 card • Integrated Mobile Broadband 4G LTE, Intel XMM™ 7160 (Fibocom L831-EAU), M.2 card (EMEA only)								Battery	Li-Ion 3-cell (<i>24Wh</i>) or 6-cell (<i>48Wh or 72Wh</i>)							
SIM card (<i>opt</i>)	Micro-SIM card slot, opt Verizon LTE (US) or Lenovo® Connect (EMEA) SIM card								Max battery life ¹⁰ (<i>MobileMark® 2014</i>)	<i>Models</i>		<i>3-cell</i>		<i>6-cell 48Wh</i>		<i>6-cell 72Wh</i>	
									<i>Integrated model</i>	7.24 hr		14.48 hr		21.72 hr			
									<i>discrete model</i>	4.34 hr		8.68 hr		13.02 hr			
									AC adapter	45W or 65W AC adapter							
									Preload	Windows® 7 Professional 64 preinstalled through downgrade rights in Windows 10 Pro 64 • Lenovo Solution Center • Lenovo PowerEngage • ThinkVantage Product Recovery • ThinkVantage System Update • Adobe® Reader® • Microsoft® Office preloaded; purchase a product key to activate • McAfee® LiveSafe™ (30-day trial) <i>Some:</i> Windows 10 Home 64 <i>Some:</i> Windows 10 Pro 64 • Lenovo Companion • Lenovo Setting • Microsoft Office preloaded; purchase a product key to activate							
									Limited warranty	<i>One of the following, configurable by model:</i> • 1-year depot repair service • 3-year/1-yr battery depot repair service • 3-year/1-yr battery limited onsite service							
									Mil-Spec test	MIL-STD-810G military certification							
									Environment	EPEAT™ Gold (US only); ENERGY STAR® 6.1; RoHS-compliant							

Model	Region	Processor	vPro	Graphics	Memory	Display	Multi-touch	Storage	Optical	WLAN + Bluetooth	WWAN	SIM Card	Smart Card Reader	Camera	Keyboard	Fingerprint Reader	TPM	Battery	Power Adapter	Operating System	Warranty	Ann Date (m/y)
20J4000RUS	US	i5-7200U	No	Intel HD 620	4GBx1	14" FHD (1920x1080) IPS	None	500GB 7200rpm	None	Intel 8265 ac, 2x2 + BT4.1	WWAN Upgradable	None	None	720p	Non-backlit	None	dTPM 2.0	6-cell (48Wh)	45W	Win10 Pro 64	1-year, Depot	01/17
20J4000SUS	US	i5-7200U	No	Intel HD 620	4GBx1	14" FHD (1920x1080) IPS	None	256GB SSD Opal2	None	Intel 8265 ac, 2x2 + BT4.1	WWAN Upgradable	None	None	720p	Non-backlit	None	dTPM 2.0	6-cell (48Wh)	45W	Win10 Pro 64	3-year, Depot	01/17
20J4000TUS	US	i5-7200U	No	Intel HD 620	4GBx1	14" HD (1366x768)	None	500GB 7200rpm	None	Intel 8265 ac, 2x2 + BT4.1	WWAN Upgradable	None	None	720p	Non-backlit	None	dTPM 2.0	6-cell (48Wh)	45W	Win10 Pro 64	1-year, Depot	01/17
20J4000UUS	US	i5-7200U	No	Intel HD 620	4GBx1	14" HD (1366x768)	None	256GB SSD Opal2	None	Intel 8265 ac, 2x2 + BT4.1	WWAN Upgradable	None	None	720p	Non-backlit	None	dTPM 2.0	6-cell (48Wh)	45W	Win10 Pro 64	3-year, Depot	01/17
20J40012US	US	i3-7100U	No	Intel HD 620	4GBx1	14" HD (1366x768)	None	500GB 7200rpm	None	Intel 8265 ac, 2x2 + BT4.1	WWAN Upgradable	None	None	720p	Non-backlit	None	dTPM 2.0	6-cell (48Wh)	45W	Win10 Pro 64	1-year, Depot	01/17
20J40013US	US	i5-7200U	No	Intel HD 620	8GBx1	14" FHD (1920x1080) IPS	None	256GB SSD Opal2	None	Intel 8265 ac, 2x2 + BT4.1	WWAN Upgradable	None	None	720p	Non-backlit	Fingerprint Reader	dTPM 2.0	6-cell (48Wh)	45W	Win10 Pro 64	1-year, Depot	01/17
20J40014US	US	i5-7300U	vPro	Intel HD 620	4GBx1	14" HD (1366x768)	None	500GB 7200rpm	None	Intel 8265 ac, 2x2 + BT4.1	WWAN Upgradable	None	None	720p	Non-backlit	None	dTPM 2.0	6-cell (48Wh)	45W	Win10 Pro 64	1-year, Depot	01/17
20J40015US	US	i5-7300U	vPro	Intel HD 620	8GBx1	14" FHD (1920x1080) IPS	None	256GB SSD Opal2	None	Intel 8265 ac, 2x2 + BT4.1	WWAN Upgradable	None	None	720p	Non-backlit	Fingerprint Reader	dTPM 2.0	6-cell (48Wh)	45W	Win10 Pro 64	1-year, Depot	01/17
20J40016US	US	i5-7200U	No	Intel HD 620	8GBx1	14" HD (1366x768)	None	256GB SSD Opal2	None	Intel 8265 ac, 2x2 + BT4.1	WWAN Upgradable	None	None	720p	Non-backlit	None	dTPM 2.0	6-cell (48Wh)	45W	Win10 Pro 64	3-year, Depot	01/17



ThinkPad L560 Platform Specifications

Product Specifications Reference (PSREF)

Processor	Intel® Celeron® processor or 6th Generation Intel Core™ i3 / i5 / i7 Processor								ExpressCard (opt) One slot (ExpressCard/34) Smart card reader Optional: Smart card reader Media reader 4-in-1 reader (MMC, SD, SDHC, SDXC) Ports <i>Cel 3855U model:</i> three USB 3.0, one USB 2.0 Always On; <i>Other model:</i> four USB 3.0 (one Always On), <i>All:</i> VGA, Mini DisplayPort, Ethernet (RJ-45), Dock connector	
	Processor Number	# of Cores	# of Threads	Base Frequency	Max Turbo Frequency	Cache	Memory Types	Processor Graphics		
	Cel 3855U	2	4	1.6 GHz	-	2MB	DDR3L-1600	Intel HD graphics 510		
	i3-6006U			2.0 GHz	-	3MB		Intel HD graphics 520		
	i3-6100U			2.3 GHz	-	3MB				
	i5-6200U			2.3 GHz	2.8 GHz	3MB				
	i5-6300U			2.4 GHz	3.0 GHz	3MB				
i7-6600U	2.6 GHz			3.4 GHz	4MB					
Camera (optional)	HD720p resolution, low light sensitive, fixed focus									
Audio support	HD Audio, Realtek® ALC3245 codec / stereo speakers, 1.5W x 2 / dual array microphone, combo audio/microphone jack									
Keyboard	6-row, spill-resistant, multimedia Fn keys, numeric keypad									
UltraNav™	TrackPoint® pointing device and buttonless Mylar surface multi-touch touchpad									
Graphics	Intel HD Graphics 510 or 520 in processor, supports external analog monitor via VGA and digital monitor via Mini DisplayPort; supports three independent displays; Max resolution: 3840x2160@60Hz (DP via mDP cable); 1920x1200@60Hz (VGA)								Security Security chip ThinkEngine	Power-on password, hard disk password, supervisor password, security keyhole Discrete TPM 1.2 TCG Certified and Firmware TPM 2.0 integrated in chipset Delivers improved thermal and power efficiency, up to 30 day standby, faster resume time, enhanced security, as well as anti-tampering measures
Chipset	Intel SoC (System on Chip) platform								vPro (optional)	Intel vPro Technology
Memory	16GB max ⁷ / PC3-12800 1600MHz DDR3L, non-parity, dual-channel capable, two DDR3L SO-DIMM sockets								Fingerprint reader	Optional: Swipe style fingerprint reader on the palm rest
Display	<i>Some:</i> 15.6" (396mm) HD (1366x768), anti-glare, LED backlight, 220 nits, 16:9 aspect ratio, 350:1 contrast ratio <i>Some:</i> 15.6" (396mm) FHD (1920x1080), anti-glare, LED backlight, IPS, 250 nits, 16:9 aspect ratio, 600:1 contrast ratio, 160° viewing angle								Battery	Li-Ion 6-cell (48Wh)
Multi-touch	None								Max battery life ¹⁰	MobileMark® 2014: 11.2 hr
Storage	<i>Some:</i> SSD / SATA 6.0Gb/s, 2.5" wide, 7mm high <i>Some:</i> HDD / SATA 6.0Gb/s, 2.5" wide, 7mm high, Shock Mounted Hard Drive, Active Protection System™ <i>Some:</i> SSHD with 8GB NAND flash memory								AC adapter	45W AC adapter
Optical (optional)	DVD burner, 9mm high, fixed, not removable, tray-in								Preload	Windows 7 Professional 64 preinstalled through downgrade rights in Windows 10 Pro 64 • Lenovo Solution Center • Lenovo Companion • Lenovo Setting • Microsoft Office preloaded; purchase a product key to activate • McAfee® LiveSafe™ (30-day trial)
Ethernet	<i>Non-vPro model:</i> Intel Ethernet Connection I219-V (Jacksonville) <i>vPro model:</i> Intel Ethernet Connection I219-LM (Jacksonville)								Limited warranty ¹²	One of the following, configurable by model: • 1-year depot repair service • 3-year/1-yr battery depot repair service • 3-year/1-yr battery limited onsite service ²⁴ • 3-year/1-yr battery limited onsite service, OID (Onsite International Delivery)
WLAN ⁴	One of the following, configurable by model: • 11ac+BT, Broadcom BCM4356, 2x2, M.2 card • 11ac+BT, Intel Dual Band Wireless-AC 8260, 2x2, M.2 card								Mil-Spec test	MIL-STD-810G military certification
Bluetooth™	Bluetooth 4.1 wireless, integrated in Wi-Fi + Bluetooth combo adapter								Environment	EPEAT™ Gold (US); ENERGY STAR® 6.1; GREENGUARD®; RoHS-compliant
WWAN (optional)	One of the following, configurable by model: • Wireless WAN upgradable • Wireless WAN, Sierra Wireless EM7455, Qualcomm® 4G LTE-Advanced/DC-HSPA+/HSPA+/HSPA/UMTS/GNSS, M.2 card • Wireless WAN, HUAWEI ME906S, HUAWEI 4G LTE/WCDMA/HSPA/GSM/GPRS/EDGE/GNSS, M.2 card (WE only)									
SIM card (opt)	Micro-SIM card slot, optional Verizon LTE (US) or Lenovo Connect (WE) SIM card									
Dimensions ³	WxDxH: 14.84" x 9.75" x 1.08-1.21"; 377mm x 255mm x 27.6-30.85mm									
Weight ²	from 5.25 lb / 2.38 kg									
Case material	PolyCarbonate/Acrylonitrile-Butadiene-Styrene (PC/ABS) plastic									

Model	Region	Processor	vPro	Graphics	Memory	Display	Multi-touch	Storage	Optical	WLAN + Bluetooth	WWAN	SIM Card	Smart Card Reader	Express-Card	Camera	Keyboard	Fingerprint Reader	Battery	Power Adapter	Operating System	Warranty	Ann Date (m/y)
20F1000PUS	US	i5-6200U	No	Intel HD 520	4GBx1	15.6" HD (1366x768)	None	192GB SSD	DVD±RW	Intel 8260 ac, 2x2 + BT4.1	None	None	None	None	720p	Non-backlit	None	6-cell (48Wh)	45W	Win10 Pro 64	1-year, Depot	02/16
20F1000QUS	US	i5-6300U	vPro	Intel HD 520	8GBx1	15.6" FHD (1920x1080) IPS	None	256GB SSD Opal2	DVD±RW	Intel 8260 ac, 2x2 + BT4.1	None	None	None	None	720p	Non-backlit	Fingerprint Reader	6-cell (48Wh)	45W	Win10 Pro 64	1-year, Depot	02/16
20F1000RUS	US	i5-6200U	No	Intel HD 520	4GBx1	15.6" HD (1366x768)	None	128GB SSD	DVD±RW	Intel 8260 ac, 2x2 + BT4.1	None	None	None	None	720p	Non-backlit	None	6-cell (48Wh)	45W	Win10 Pro 64	1-year, Depot	02/16
20F1000SUS	US	i5-6200U	No	Intel HD 520	4GBx1	15.6" HD (1366x768)	None	500GB 7200rpm	DVD±RW	Intel 8260 ac, 2x2 + BT4.1	None	None	None	None	720p	Non-backlit	None	6-cell (48Wh)	45W	Win10 Pro 64	1-year, Depot	02/16
20F1000TUS	US	i3-6100U	No	Intel HD 520	4GBx1	15.6" HD (1366x768)	None	500GB 7200rpm	DVD±RW	Intel 8260 ac, 2x2 + BT4.1	None	None	None	None	720p	Non-backlit	None	6-cell (48Wh)	45W	Win10 Pro 64	1-year, Depot	02/16
20F1000UUS	US	i5-6300U	vPro	Intel HD 520	4GBx1	15.6" HD (1366x768)	None	128GB SSD	DVD±RW	Intel 8260 ac, 2x2 + BT4.1	None	None	None	None	720p	Non-backlit	None	6-cell (48Wh)	45W	Win10 Pro 64	1-year, Depot	02/16
20F1000VUS	US	i5-6200U	No	Intel HD 520	8GBx1	15.6" FHD (1920x1080) IPS	None	256GB SSD Opal2	DVD±RW	Intel 8260 ac, 2x2 + BT4.1	None	None	None	None	720p	Non-backlit	Fingerprint Reader	6-cell (48Wh)	45W	Win10 Pro 64	1-year, Depot	02/16
20F1000WUS	US	i3-6100U	No	Intel HD 520	4GBx1	15.6" HD (1366x768)	None	192GB SSD	DVD±RW	Intel 8260 ac, 2x2 + BT4.1	None	None	None	None	720p	Non-backlit	None	6-cell (48Wh)	45W	Win10 Pro 64	1-year, Depot	02/16
20F1000XUS	US	i5-6300U	vPro	Intel HD 520	4GBx1	15.6" HD (1366x768)	None	500GB 7200rpm	DVD±RW	Intel 8260 ac, 2x2 + BT4.1	None	None	None	None	720p	Non-backlit	None	6-cell (48Wh)	45W	Win10 Pro 64	1-year, Depot	02/16
20F1001MUS	US	i3-6100U	No	Intel HD 520	4GBx1	15.6" HD (1366x768)	None	500GB 7200rpm	DVD±RW	Intel 8260 ac, 2x2 + BT4.1	None	None	None	None	720p	Non-backlit	None	6-cell (48Wh)	45W	Win10 DG Win7 Pro 64	1-year, Depot	02/16
20F1001NUS	US	i3-6100U	No	Intel HD 520	4GBx1	15.6" HD (1366x768)	None	192GB SSD	DVD±RW	Intel 8260 ac, 2x2 + BT4.1	None	None	None	None	720p	Non-backlit	None	6-cell (48Wh)	45W	Win10 DG Win7 Pro 64	1-year, Depot	02/16
20F1001PUS	US	i5-6200U	No	Intel HD 520	4GBx1	15.6" HD (1366x768)	None	500GB 7200rpm	DVD±RW	Intel 8260 ac, 2x2 + BT4.1	None	None	None	None	720p	Non-backlit	None	6-cell (48Wh)	45W	Win10 DG Win7 Pro 64	1-year, Depot	02/16
20F1001QUS	US	i5-6200U	No	Intel HD 520	8GBx1	15.6" FHD (1920x1080) IPS	None	256GB SSD Opal2	DVD±RW	Intel 8260 ac, 2x2 + BT4.1	None	None	None	None	720p	Non-backlit	Fingerprint Reader	6-cell (48Wh)	45W	Win10 DG Win7 Pro 64	1-year, Depot	02/16
20F1001RUS	US	i5-6200U	No	Intel HD 520	4GBx1	15.6" HD (1366x768)	None	128GB SSD	DVD±RW	Intel 8260 ac, 2x2 + BT4.1	None	None	None	None	720p	Non-backlit	None	6-cell (48Wh)	45W	Win10 DG Win7 Pro 64	1-year, Depot	02/16
20F1001SUS	US	i5-6200U	No	Intel HD 520	4GBx1	15.6" HD (1366x768)	None	192GB SSD	DVD±RW	Intel 8260 ac, 2x2 + BT4.1	None	None	None	None	720p	Non-backlit	None	6-cell (48Wh)	45W	Win10 DG Win7 Pro 64	1-year, Depot	02/16
20F1001TUS	US	i5-6300U	vPro	Intel HD 520	4GBx1	15.6" HD (1366x768)	None	500GB 7200rpm	DVD±RW	Intel 8260 ac, 2x2 + BT4.1	None	None	None	None	720p	Non-backlit	None	6-cell (48Wh)	45W	Win10 DG Win7 Pro 64	1-year, Depot	02/16
20F1001UUS	US	i5-6300U	vPro	Intel HD 520	4GBx1	15.6" HD (1366x768)	None	128GB SSD	DVD±RW	Intel 8260 ac, 2x2 + BT4.1	None	None	None	None	720p	Non-backlit	None	6-cell (48Wh)	45W	Win10 DG Win7 Pro 64	1-year, Depot	02/16
20F1001VUS	US	i5-6300U	vPro	Intel HD 520	8GBx1	15.6" FHD (1920x1080) IPS	None	256GB SSD Opal2	DVD±RW	Intel 8260 ac, 2x2 + BT4.1	None	None	None	None	720p	Non-backlit	Fingerprint Reader	6-cell (48Wh)	45W	Win10 DG Win7 Pro 64	1-year, Depot	02/16
20F1002AUS	US	i5-6300U	vPro	Intel HD 520	8GBx1	15.6" FHD (1920x1080) IPS	None	256GB SSD Opal2	DVD±RW	Intel 8260 ac, 2x2 + BT4.1	Sierra EM7455	None	None	None	720p	Non-backlit	Fingerprint Reader	6-cell (48Wh)	45W	Win10 DG Win7 Pro 64	1-year, Depot	04/16
20F1002BUS	US	i5-6200U	No	Intel HD 520	8GBx1	15.6" FHD (1920x1080) IPS	None	256GB SSD Opal2	DVD±RW	Intel 8260 ac, 2x2 + BT4.1	Sierra EM7455	None	None	None	720p	Non-backlit	Fingerprint Reader	6-cell (48Wh)	45W	Win10 Pro 64	1-year, Depot	04/16

Model	Region	Processor	vPro	Graphics	Memory	Display	Multi-touch	Storage	Optical	WLAN + Bluetooth	WWAN	SIM Card	Smart Card Reader	Express-Card	Camera	Keyboard	Fingerprint Reader	Battery	Power Adapter	Operating System	Warranty	Ann Date (m/y)
20F1002CUS	US	i5-6200U	No	Intel HD 520	8GBx1	15.6" FHD (1920x1080) IPS	None	256GB SSD Opal2	DVD±RW	Intel 8260 ac, 2x2 + BT4.1	Sierra EM7455	None	None	None	720p	Non-backlit	Fingerprint Reader	6-cell (48Wh)	45W	Win10 DG Win7 Pro 64	1-year, Depot	04/16
20F1002DUS	US	i5-6300U	vPro	Intel HD 520	8GBx1	15.6" FHD (1920x1080) IPS	None	256GB SSD Opal2	DVD±RW	Intel 8260 ac, 2x2 + BT4.1	Sierra EM7455	None	None	None	720p	Non-backlit	Fingerprint Reader	6-cell (48Wh)	45W	Win10 Pro 64	1-year, Depot	04/16
20F1003PUS	US	i3-6100U	No	Intel HD 520	4GBx1	15.6" HD (1366x768)	None	256GB SSD Opal2	DVD±RW	Intel 8260 ac, 2x2 + BT4.1	WWAN Upgradable	None	None	None	720p	Non-backlit	None	6-cell (48Wh)	45W	Win10 DG Win7 Pro 64	1-year, Depot	11/16
20F1003QUS	US	i3-6100U	No	Intel HD 520	4GBx1	15.6" HD (1366x768)	None	180GB SSD Opal2	DVD±RW	Intel 8260 ac, 2x2 + BT4.1	WWAN Upgradable	None	None	None	720p	Non-backlit	None	6-cell (48Wh)	45W	Win10 DG Win7 Pro 64	1-year, Depot	11/16
20F1003RUS	US	i5-6200U	No	Intel HD 520	4GBx1	15.6" HD (1366x768)	None	180GB SSD Opal2	DVD±RW	Intel 8260 ac, 2x2 + BT4.1	WWAN Upgradable	None	None	None	720p	Non-backlit	None	6-cell (48Wh)	45W	Win10 Home 64	1-year, Depot	11/16
20F1003SUS	US	i3-6100U	No	Intel HD 520	4GBx1	15.6" HD (1366x768)	None	180GB SSD Opal2	DVD±RW	Intel 8260 ac, 2x2 + BT4.1	WWAN Upgradable	None	None	None	720p	Non-backlit	None	6-cell (48Wh)	45W	Win10 Home 64	1-year, Depot	11/16
20F1003TUS	US	i5-6200U	No	Intel HD 520	4GBx1	15.6" HD (1366x768)	None	180GB SSD Opal2	DVD±RW	Intel 8260 ac, 2x2 + BT4.1	WWAN Upgradable	None	None	None	720p	Non-backlit	None	6-cell (48Wh)	45W	Win10 DG Win7 Pro 64	1-year, Depot	11/16
20F1003UUS	US	i5-6200U	No	Intel HD 520	4GBx1	15.6" HD (1366x768)	None	256GB SSD Opal2	DVD±RW	Intel 8260 ac, 2x2 + BT4.1	WWAN Upgradable	None	None	None	720p	Non-backlit	None	6-cell (48Wh)	45W	Win10 Home 64	1-year, Depot	11/16
20F1003VUS	US	i5-6200U	No	Intel HD 520	4GBx1	15.6" HD (1366x768)	None	256GB SSD Opal2	DVD±RW	Intel 8260 ac, 2x2 + BT4.1	WWAN Upgradable	None	None	None	720p	Non-backlit	None	6-cell (48Wh)	45W	Win10 DG Win7 Pro 64	1-year, Depot	11/16
20F1003WUS	US	i3-6100U	No	Intel HD 520	4GBx1	15.6" HD (1366x768)	None	256GB SSD Opal2	DVD±RW	Intel 8260 ac, 2x2 + BT4.1	WWAN Upgradable	None	None	None	720p	Non-backlit	None	6-cell (48Wh)	45W	Win10 Home 64	1-year, Depot	11/16
20F1004AUS	US	i3-6006U	No	Intel HD 520	4GBx1	15.6" HD (1366x768)	None	256GB SSD Opal2	DVD±RW	Intel 8260 ac, 2x2 + BT4.1	WWAN Upgradable	None	None	None	720p	Non-backlit	None	6-cell (48Wh)	45W	Win10 Pro 64	1-year, Depot	12/16
20F1004BUS	US	i3-6006U	No	Intel HD 520	4GBx1	15.6" HD (1366x768)	None	180GB SSD Opal2	DVD±RW	Intel 8260 ac, 2x2 + BT4.1	WWAN Upgradable	None	None	None	720p	Non-backlit	None	6-cell (48Wh)	45W	Win10 DG Win7 Pro 64	1-year, Depot	12/16
20F1004CUS	US	i3-6006U	No	Intel HD 520	4GBx1	15.6" HD (1366x768)	None	256GB SSD Opal2	DVD±RW	Intel 8260 ac, 2x2 + BT4.1	WWAN Upgradable	None	None	None	720p	Non-backlit	None	6-cell (48Wh)	45W	Win10 DG Win7 Pro 64	1-year, Depot	12/16
20F1004DUS	US	i3-6006U	No	Intel HD 520	4GBx1	15.6" HD (1366x768)	None	180GB SSD Opal2	DVD±RW	Intel 8260 ac, 2x2 + BT4.1	WWAN Upgradable	None	None	None	720p	Non-backlit	None	6-cell (48Wh)	45W	Win10 Pro 64	1-year, Depot	12/16



ThinkPad P50 Platform Specifications

Product Specifications Reference (PSREF)

Processor	6th Generation Intel® Core™ i7 Processor or Intel Xeon® Processor E3 v5 Family							Smart card reader ExpressCard Media reader Ports	Optional: Smart card reader One slot (ExpressCard/34) 4-in-1 reader (MMC, SD, SDHC, SDXC), supports UHS-II SD card Four USB 3.0 (one Always On), USB Type-C / Thunderbolt 3, Mini DisplayPort, HDMI, Ethernet (RJ-45), Dock connector									
	Processor Number	# of Cores	# of Threads	Base Frequency	Max Turbo Frequency	Cache	Memory Types			Processor Graphics								
	i7-6700HQ	4	8	2.6 GHz	3.5 GHz	6MB	DDR4-2133			Intel HD Graphics 530								
	i7-6820HQ			2.7 GHz	3.6 GHz	8MB				Intel HD Graphics P530								
	E3-1505M v5			2.8 GHz	3.7 GHz	8MB												
E3-1535M v5	2.9 GHz			3.8 GHz	8MB													
Graphics	Intel HD Graphics 530 or P530 in processor and NVIDIA Quadro® M1000M (2GB or 4GB memory) or M2000M (4GB memory); supports external digital monitor via HDMI, Mini DisplayPort, or Thunderbolt™; supports four independent displays; Max resolution: 3840x2160@60Hz (DisplayPort via Mini DisplayPort cable); 3840x2160@60Hz (Thunderbolt); 3840x2160@30Hz (HDMI)							Camera (optional) Audio support	HD720p resolution, low light sensitive, fixed focus HD Audio, Realtek® ALC3268 codec / stereo speakers, 1.5W x 2 / dual array microphone, combo audio/microphone jack									
Chipset Memory	Mobile Intel CM236 Chipset (Intel GL82CM236 PCH) 64GB max ⁷ / 2133MHz DDR4, ECC or non-ECC (ECC function supported only on Xeon processor), dual-channel capable, four DDR4 SO-DIMM sockets							Keyboard UltraNav™	6-row, spill-resistant, multimedia Fn keys, numeric keypad, optional LED backlight 3-button TrackPoint® pointing device and 3-button crystal silk surface multi-touch touchpad									
Display	Some: 15.6" (396mm) FHD (1920x1080), anti-glare, LED backlight, IPS, 250 nits, 16:9 aspect ratio, 600:1 contrast ratio, 45% gamut, 160° viewing angle Some: 15.6" (396mm) 4K (3840x2160), anti-glare, LED backlight, IPS, 300 nits, 16:9 aspect ratio, 1000:1 contrast ratio, 100% gamut, 178° viewing angle							Security Security chip ThinkEngine	Power-on password, hard disk password, supervisor password, security keyhole Discrete TPM 1.2 TCG Certified and Firmware TPM 2.0 integrated in chipset Delivers improved thermal and power efficiency, up to 30 day standby, faster resume time, enhanced security, as well as anti-tampering measures									
Multi-touch (opt) Pen (optional)	Capacitive-type multi-touch, supports 10-finger gesture, 220 nits ThinkPad Pen Pro, active pen for multi-touch display							vPro (optional) Fingerprint reader Color calibration	Intel vPro Technology Touch style fingerprint reader on the palm rest Optional: Pantone® color calibrator by X-Rite® color calibration sensor in palm rest									
Storage	Up to 3 drives (two M.2 SSD and one HDD) Some: M.2 SSD / SATA 6.0Gb/s (e.g. xxxG SSD) Some: M.2 SSD / PCIe NVMe, PCIe 3.0 x 4, 32Gb/s (e.g. xxxG SSD PCIe NVMe) Some: HDD / SATA 6.0Gb/s, 2.5" wide, 7mm high, Shock Mounted Hard Drive, Active Protection System™							Battery Max battery life ¹⁰ (MobileMark® 2014)	Lithium Polymer 4-cell (66Wh) or 6-cell (90Wh) <table border="1"> <thead> <tr> <th>Model</th> <th>4-cell</th> <th>6-cell</th> </tr> </thead> <tbody> <tr> <td>Discrete Graphics</td> <td>7.1 hr</td> <td>9.7 hr</td> </tr> <tr> <td>Hybrid Graphics</td> <td>9.6 hr</td> <td>13.2 hr</td> </tr> </tbody> </table>	Model	4-cell	6-cell	Discrete Graphics	7.1 hr	9.7 hr	Hybrid Graphics	9.6 hr	13.2 hr
Model	4-cell	6-cell																
Discrete Graphics	7.1 hr	9.7 hr																
Hybrid Graphics	9.6 hr	13.2 hr																
Optical	None							AC adapter	170W AC adapter									
Ethernet	Non-vPro model: Intel Ethernet Connection I219-V (Jacksonville) vPro model: Intel Ethernet Connection I219-LM (Jacksonville)							Preload	Some: Genuine Windows® 7 Professional 64 Some: Windows 7 Professional 64 preinstalled through downgrade rights in Windows 10 Pro 64 <ul style="list-style-type: none"> Lenovo Solution Center Lenovo SHAREit ThinkVantage Product Recovery Rescue and Recovery™ ThinkVantage System Update Adobe® Reader® Microsoft® Office preloaded; purchase a product key to activate McAfee® LiveSafe™ (30-day trial) For ISV certifications, please visit www.lenovo.com/support/ISV									
WLAN ⁴ Bluetooth™	11ac+BT, Intel Dual Band Wireless-AC 8260, 2x2, M.2 card Bluetooth 4.1 wireless, integrated in Wi-Fi + Bluetooth combo adapter							Windows 10 Pro 64 <ul style="list-style-type: none"> Lenovo Solution Center Lenovo SHAREit Lenovo Companion Lenovo Setting Microsoft Office preloaded; purchase a product key to activate McAfee® LiveSafe™ (30-day trial) 										
WWAN (optional)	Wireless WAN, Sierra Wireless EM7455, Qualcomm® 4G LTE-Advanced/DC-HSPA+/HSPA/HSPA/UMTS/GNSS, M.2 card																	
SIM card	Micro-SIM card slot																	
Dimensions ³	WxDxH: 14.86" x 9.93" x 0.96-1.16"; 377.4mm x 252.3mm x 24.5-29.4mm WxDxH(Touch): 14.86" x 9.93" x 1.02-1.21"; 377.4mm x 252.3mm x 25.8-30.7mm							Limited warranty ¹²	One of the following, configurable by model: <ul style="list-style-type: none"> 3-year/1-yr battery depot repair service 3-year/1-yr battery limited onsite service²⁴ 3-year/1-yr battery limited onsite service, OID (Onsite International Delivery) 									
Weight ²	<table border="1"> <thead> <tr> <th>Models</th> <th>4-cell</th> <th>6-cell</th> </tr> </thead> <tbody> <tr> <td>Non-touch</td> <td>5.6 lb / 2.55kg</td> <td>5.9 lb / 2.67kg</td> </tr> <tr> <td>Multi-touch</td> <td>6.2 lb / 2.82kg</td> <td>6.4 lb / 2.90kg</td> </tr> </tbody> </table>							Models	4-cell	6-cell	Non-touch	5.6 lb / 2.55kg	5.9 lb / 2.67kg	Multi-touch	6.2 lb / 2.82kg	6.4 lb / 2.90kg	Mil-Spec test	MIL-STD-810G military certification
Models	4-cell	6-cell																
Non-touch	5.6 lb / 2.55kg	5.9 lb / 2.67kg																
Multi-touch	6.2 lb / 2.82kg	6.4 lb / 2.90kg																
Case material	Display cover: Glass-Fiber Reinforced Plastic; Bottom: Magnesium/Aluminum							Environment	EPEAT™ Gold (US only); ENERGY STAR® 6.1; GREENGUARD®; RoHS-compliant									

Model	Region	Processor	vPro	Graphics	Memory	Display	Multi-touch	Pen	Storage(HDD/SSD)	RAID	Optical	WLAN + Bluetooth	WWAN	SIM Card	Smart Card Reader	Camera	Keyboard	Fingerprint Reader	Color Calibrator	Battery	Power Adapter	Operating System	Warranty	Ann Date (m/y)
20EN0012US	US	i7-6700HQ	No	M1000M 2GB	8GBx1 non-ECC	15.6" FHD (1920x1080) IPS	None	None	256GB SSD M.2 Opal2	No	None	Intel 8260 ac, 2x2 + BT4.1	None	None	None	720p	Backlit	Fingerprint Reader	None	6-cell (90Wh)	170W	Win10 DG Win7 Pro 64	3-year, Depot	11/15
20EN0013US	US	i7-6700HQ	No	M1000M 2GB	8GBx1 non-ECC	15.6" FHD (1920x1080) IPS	None	None	500GB 7200rpm	No	None	Intel 8260 ac, 2x2 + BT4.1	None	None	None	720p	Backlit	Fingerprint Reader	None	6-cell (90Wh)	170W	Win10 DG Win7 Pro 64	3-year, Depot	11/15
20EN0014US	US	i7-6700HQ	No	M1000M 2GB	8GBx1 non-ECC	15.6" FHD (1920x1080) IPS	None	None	1TB 5400rpm	No	None	Intel 8260 ac, 2x2 + BT4.1	None	None	None	720p	Backlit	Fingerprint Reader	None	6-cell (90Wh)	170W	Win10 DG Win7 Pro 64	3-year, Depot	11/15
20EN0015US	US	i7-6700HQ	No	M1000M 2GB	16GBx1 non-ECC	15.6" FHD (1920x1080) IPS	None	None	512GB SSD M.2 PCIe NVMe	No	None	Intel 8260 ac, 2x2 + BT4.1	None	None	None	720p	Backlit	Fingerprint Reader	None	6-cell (90Wh)	170W	Win10 DG Win7 Pro 64	3-year, Depot	11/15
20EN0016US	US	i7-6820HQ	vPro	M1000M 2GB	8GBx1 non-ECC	15.6" FHD (1920x1080) IPS	None	None	500GB 7200rpm	No	None	Intel 8260 ac, 2x2 + BT4.1	None	None	None	720p	Backlit	Fingerprint Reader	None	6-cell (90Wh)	170W	Win10 DG Win7 Pro 64	3-year, Depot	11/15
20EN0017US	US	i7-6820HQ	vPro	M1000M 2GB	8GBx1 non-ECC	15.6" FHD (1920x1080) IPS	None	None	1TB 5400rpm	No	None	Intel 8260 ac, 2x2 + BT4.1	None	None	None	720p	Backlit	Fingerprint Reader	None	6-cell (90Wh)	170W	Win10 DG Win7 Pro 64	3-year, Depot	11/15
20EN0018US	US	i7-6820HQ	vPro	M1000M 2GB	8GBx1 non-ECC	15.6" FHD (1920x1080) IPS	None	None	256GB SSD M.2 Opal2	No	None	Intel 8260 ac, 2x2 + BT4.1	None	None	None	720p	Backlit	Fingerprint Reader	None	6-cell (90Wh)	170W	Win10 DG Win7 Pro 64	3-year, Depot	11/15
20EN0019US	US	i7-6820HQ	vPro	M1000M 2GB	16GBx1 non-ECC	15.6" FHD (1920x1080) IPS	None	None	512GB SSD M.2 PCIe NVMe	No	None	Intel 8260 ac, 2x2 + BT4.1	None	None	None	720p	Backlit	Fingerprint Reader	None	6-cell (90Wh)	170W	Win10 DG Win7 Pro 64	3-year, Depot	11/15
20EN001AUS	US	i7-6820HQ	vPro	M2000M 4GB	8GBx1 non-ECC	15.6" FHD (1920x1080) IPS	None	None	500GB 7200rpm	No	None	Intel 8260 ac, 2x2 + BT4.1	None	None	None	720p	Backlit	Fingerprint Reader	None	6-cell (90Wh)	170W	Win10 DG Win7 Pro 64	3-year, Depot	11/15
20EN001BUS	US	i7-6820HQ	vPro	M2000M 4GB	8GBx1 non-ECC	15.6" FHD (1920x1080) IPS	None	None	256GB SSD M.2 Opal2	No	None	Intel 8260 ac, 2x2 + BT4.1	None	None	None	720p	Backlit	Fingerprint Reader	None	6-cell (90Wh)	170W	Win10 DG Win7 Pro 64	3-year, Depot	11/15
20EN001CUS	US	i7-6820HQ	vPro	M2000M 4GB	16GBx1 non-ECC	15.6" FHD (1920x1080) IPS	None	None	512GB SSD M.2 PCIe NVMe	No	None	Intel 8260 ac, 2x2 + BT4.1	None	None	None	720p	Backlit	Fingerprint Reader	None	6-cell (90Wh)	170W	Win10 DG Win7 Pro 64	3-year, Depot	11/15
20EN001DUS	US	i7-6820HQ	vPro	M2000M 4GB	16GBx1 non-ECC	15.6" 4K (3840x2160) IPS	None	None	500GB 7200rpm	No	None	Intel 8260 ac, 2x2 + BT4.1	None	None	None	720p	Backlit	Fingerprint Reader	X-Rite	6-cell (90Wh)	170W	Win10 DG Win7 Pro 64	3-year, Depot	11/15
20EN001EUS	US	i7-6820HQ	vPro	M2000M 4GB	16GBx1 non-ECC	15.6" 4K (3840x2160) IPS	None	None	256GB SSD M.2 Opal2	No	None	Intel 8260 ac, 2x2 + BT4.1	None	None	None	720p	Backlit	Fingerprint Reader	X-Rite	6-cell (90Wh)	170W	Win10 DG Win7 Pro 64	3-year, Depot	11/15
20EN001FUS	US	i7-6820HQ	vPro	M2000M 4GB	16GBx1 non-ECC	15.6" 4K (3840x2160) IPS	None	None	512GB SSD M.2 PCIe NVMe	No	None	Intel 8260 ac, 2x2 + BT4.1	None	None	None	720p	Backlit	Fingerprint Reader	X-Rite	6-cell (90Wh)	170W	Win10 DG Win7 Pro 64	3-year, Depot	11/15
20EN001GUS	US	i7-6700HQ	No	M1000M 2GB	8GBx1 non-ECC	15.6" FHD (1920x1080) IPS	10-point Multi-touch	None	500GB 7200rpm	No	None	Intel 8260 ac, 2x2 + BT4.1	None	None	None	720p	Backlit	Fingerprint Reader	X-Rite	6-cell (90Wh)	170W	Win10 Pro 64	3-year, Depot	11/15
20EN001HUS	US	i7-6700HQ	No	M1000M 2GB	8GBx1 non-ECC	15.6" FHD (1920x1080) IPS	10-point Multi-touch	None	256GB SSD M.2 Opal2	No	None	Intel 8260 ac, 2x2 + BT4.1	None	None	None	720p	Backlit	Fingerprint Reader	X-Rite	6-cell (90Wh)	170W	Win10 Pro 64	3-year, Depot	11/15
20EN001JUS	US	i7-6820HQ	vPro	M1000M 2GB	8GBx1 non-ECC	15.6" FHD (1920x1080) IPS	10-point Multi-touch	None	500GB 7200rpm	No	None	Intel 8260 ac, 2x2 + BT4.1	None	None	None	720p	Backlit	Fingerprint Reader	X-Rite	6-cell (90Wh)	170W	Win10 Pro 64	3-year, Depot	11/15
20EN001KUS	US	i7-6820HQ	vPro	M1000M 2GB	8GBx1 non-ECC	15.6" FHD (1920x1080) IPS	10-point Multi-touch	None	256GB SSD M.2 Opal2	No	None	Intel 8260 ac, 2x2 + BT4.1	None	None	None	720p	Backlit	Fingerprint Reader	X-Rite	6-cell (90Wh)	170W	Win10 Pro 64	3-year, Depot	11/15
20EN001LUS	US	i7-6820HQ	vPro	M2000M 4GB	16GBx1 non-ECC	15.6" FHD (1920x1080) IPS	10-point Multi-touch	None	256GB SSD M.2 Opal2	No	None	Intel 8260 ac, 2x2 + BT4.1	None	None	None	720p	Backlit	Fingerprint Reader	X-Rite	6-cell (90Wh)	170W	Win10 Pro 64	3-year, Depot	11/15
20EN001MUS	US	i7-6820HQ	vPro	M2000M 4GB	16GBx1 non-ECC	15.6" FHD (1920x1080) IPS	10-point Multi-touch	None	512GB SSD M.2 PCIe NVMe	No	None	Intel 8260 ac, 2x2 + BT4.1	None	None	None	720p	Backlit	Fingerprint Reader	X-Rite	6-cell (90Wh)	170W	Win10 Pro 64	3-year, Depot	11/15

Model	Region	Processor	vPro	Graphics	Memory	Display	Multi-touch	Pen	Storage(HDD/SSD)	RAID	Optical	WLAN + Bluetooth	WWAN	SIM Card	Smart Card Reader	Camera	Keyboard	Fingerprint Reader	Color Calibrator	Battery	Power Adapter	Operating System	Warranty	Ann Date (m/y)
20EN001NUS	US	Xeon E3-1505M v5	vPro	M2000M 4GB	16GBx1 non-ECC	15.6" FHD (1920x1080) IPS	10-point Multi-touch	None	256GB SSD M.2 Opal2	No	None	Intel 8260 ac, 2x2 + BT4.1	None	None	None	720p	Backlit	Fingerprint Reader	X-Rite	6-cell (90Wh)	170W	Win10 Pro 64	3-year, Depot	11/15
20EN001PUS	US	Xeon E3-1505M v5	vPro	M2000M 4GB	16GBx1 non-ECC	15.6" FHD (1920x1080) IPS	10-point Multi-touch	None	512GB SSD M.2 PCIe NVMe	No	None	Intel 8260 ac, 2x2 + BT4.1	None	None	None	720p	Backlit	Fingerprint Reader	X-Rite	6-cell (90Wh)	170W	Win10 Pro 64	3-year, Depot	11/15
20EN001QUS	US	Xeon E3-1505M v5	vPro	M2000M 4GB	16GBx1 non-ECC	15.6" 4K (3840x2160) IPS	None	None	256GB SSD M.2 Opal2	No	None	Intel 8260 ac, 2x2 + BT4.1	None	None	None	720p	Backlit	Fingerprint Reader	X-Rite	6-cell (90Wh)	170W	Win10 DG Win7 Pro 64	3-year, Depot	11/15
20EN001RUS	US	Xeon E3-1505M v5	vPro	M2000M 4GB	16GBx1 non-ECC	15.6" 4K (3840x2160) IPS	None	None	512GB SSD M.2 PCIe NVMe	No	None	Intel 8260 ac, 2x2 + BT4.1	None	None	None	720p	Backlit	Fingerprint Reader	X-Rite	6-cell (90Wh)	170W	Win10 DG Win7 Pro 64	3-year, Depot	11/15
20EN001SUS	US	Xeon E3-1505M v5	vPro	M2000M 4GB	16GBx1 non-ECC	15.6" FHD (1920x1080) IPS	None	None	256GB SSD M.2 Opal2	No	None	Intel 8260 ac, 2x2 + BT4.1	None	None	None	720p	Backlit	Fingerprint Reader	None	6-cell (90Wh)	170W	Win10 DG Win7 Pro 64	3-year, Depot	11/15
20EN001TUS	US	Xeon E3-1505M v5	vPro	M2000M 4GB	16GBx1 non-ECC	15.6" FHD (1920x1080) IPS	None	None	512GB SSD M.2 PCIe NVMe	No	None	Intel 8260 ac, 2x2 + BT4.1	None	None	None	720p	Backlit	Fingerprint Reader	None	6-cell (90Wh)	170W	Win10 DG Win7 Pro 64	3-year, Depot	11/15
20EN002FUS	US	i7-6700HQ	No	M1000M 2GB	16GBx1 non-ECC	15.6" FHD (1920x1080) IPS	None	None	500GB 7200rpm	No	None	Intel 8260 ac, 2x2 + BT4.1	None	None	None	720p	Backlit	Fingerprint Reader	None	6-cell (90Wh)	170W	Win10 DG Win7 Pro 64	3-year, Depot	11/15
20EN002GUS	US	i7-6700HQ	No	M1000M 2GB	16GBx1 non-ECC	15.6" FHD (1920x1080) IPS	None	None	500GB 7200rpm	No	None	Intel 8260 ac, 2x2 + BT4.1	None	None	None	720p	Backlit	Fingerprint Reader	None	6-cell (90Wh)	170W	Win10 Pro 64	3-year, Depot	11/15
20EN002HUS	US	i7-6700HQ	No	M1000M 2GB	16GBx1 non-ECC	15.6" FHD (1920x1080) IPS	None	None	256GB SSD M.2 Opal2	No	None	Intel 8260 ac, 2x2 + BT4.1	None	None	None	720p	Backlit	Fingerprint Reader	None	6-cell (90Wh)	170W	Win10 DG Win7 Pro 64	3-year, Depot	11/15
20EN002JUS	US	i7-6700HQ	No	M1000M 2GB	16GBx1 non-ECC	15.6" FHD (1920x1080) IPS	None	None	256GB SSD M.2 Opal2	No	None	Intel 8260 ac, 2x2 + BT4.1	None	None	None	720p	Backlit	Fingerprint Reader	None	6-cell (90Wh)	170W	Win10 Pro 64	3-year, Depot	11/15
20EN002KUS	US	i7-6820HQ	vPro	M1000M 2GB	16GBx1 non-ECC	15.6" FHD (1920x1080) IPS	None	None	256GB SSD M.2 Opal2	No	None	Intel 8260 ac, 2x2 + BT4.1	None	None	None	720p	Backlit	Fingerprint Reader	None	6-cell (90Wh)	170W	Win10 DG Win7 Pro 64	3-year, Depot	11/15
20EN002LUS	US	i7-6820HQ	vPro	M1000M 2GB	16GBx1 non-ECC	15.6" FHD (1920x1080) IPS	None	None	256GB SSD M.2 Opal2	No	None	Intel 8260 ac, 2x2 + BT4.1	None	None	None	720p	Backlit	Fingerprint Reader	None	6-cell (90Wh)	170W	Win10 Pro 64	3-year, Depot	11/15
20EN002MUS	US	i7-6820HQ	vPro	M2000M 4GB	16GBx1 non-ECC	15.6" FHD (1920x1080) IPS	None	None	256GB SSD M.2 Opal2	No	None	Intel 8260 ac, 2x2 + BT4.1	None	None	None	720p	Backlit	Fingerprint Reader	None	6-cell (90Wh)	170W	Win10 DG Win7 Pro 64	3-year, Depot	11/15
20EN002NUS	US	i7-6820HQ	vPro	M2000M 4GB	16GBx1 non-ECC	15.6" FHD (1920x1080) IPS	None	None	256GB SSD M.2 Opal2	No	None	Intel 8260 ac, 2x2 + BT4.1	None	None	None	720p	Backlit	Fingerprint Reader	None	6-cell (90Wh)	170W	Win10 Pro 64	3-year, Depot	11/15
20EN002PUS	US	Xeon E3-1505M v5	vPro	M2000M 4GB	16GBx1 non-ECC	15.6" FHD (1920x1080) IPS	None	None	256GB SSD M.2 Opal2	No	None	Intel 8260 ac, 2x2 + BT4.1	None	None	None	720p	Backlit	Fingerprint Reader	None	6-cell (90Wh)	170W	Win10 Pro 64	3-year, Depot	11/15
20EN002QUS	US	i7-6820HQ	vPro	M2000M 4GB	16GBx1 non-ECC	15.6" 4K (3840x2160) IPS	None	None	256GB SSD M.2 Opal2	No	None	Intel 8260 ac, 2x2 + BT4.1	None	None	None	720p	Backlit	Fingerprint Reader	X-Rite	6-cell (90Wh)	170W	Win10 Pro 64	3-year, Depot	11/15
20EN003LUS	US	i7-6820HQ	vPro	M1000M 4GB	8GBx4 non-ECC	15.6" FHD (1920x1080) IPS	None	None	512GB SSD M.2 PCIe NVMe	No	None	Intel 8260 ac, 2x2 + BT4.1	None	None	Smart Card Reader	720p	Backlit	Fingerprint Reader	None	6-cell (90Wh)	170W	Win10 Pro 64	3-year, Depot	07/16

ThinkPad P50 - TopSeller - 20EQ

Product Specifications Reference (PSREF)

Model	Region	Processor	vPro	Graphics	Memory	Display	Multi-touch	Pen	Storage(HDD/SSD)	RAID	Optical	WLAN + Bluetooth	WWAN	SIM Card	Smart Card Reader	Camera	Keyboard	Fingerprint Reader	Color Calibrator	Battery	Power Adapter	Operating System	Warranty	Ann Date (m/y)
20EQ002DUS	US	Xeon E3-1505M v5	vPro	M2000M 4GB	16GBx1 non-ECC	15.6" FHD (1920x1080) IPS	None	None	256GB SSD M.2 Opal2	No	None	Intel 8260 ac, 2x2 + BT4.1	None	None	None	720p	Backlit	Fingerprint Reader	X-Rite	6-cell (90Wh)	170W	Win10 Pro 64	3-year, Onsite	08/16
20EQ002EUS	US	i7-6700HQ	No	M1000M 4GB	8GBx1 non-ECC	15.6" FHD (1920x1080) IPS	None	None	500GB 7200rpm	No	None	Intel 8260 ac, 2x2 + BT4.1	None	None	None	720p	Backlit	Fingerprint Reader	None	6-cell (90Wh)	170W	Win10 Pro 64	3-year, Onsite	08/16
20EQ002FUS	US	Xeon E3-1505M v5	vPro	M2000M 4GB	16GBx1 non-ECC	15.6" FHD (1920x1080) IPS	None	None	256GB SSD M.2 Opal2	No	None	Intel 8260 ac, 2x2 + BT4.1	None	None	None	720p	Backlit	Fingerprint Reader	None	6-cell (90Wh)	170W	Win10 Pro 64	3-year, Onsite	08/16



ThinkPad P50s Platform Specifications

Product Specifications Reference (PSREF)

Processor	6th Generation Intel® Core™ i5 / i7 Processor								Smart card reader <i>Optional</i> : Smart card reader								
	Processor Number	# of Cores	# of Threads	Base Frequency	Max Turbo Frequency	Cache	Memory Types	Processor Graphics	Media reader 4-in-1 reader (MMC, SD, SDHC, SDXC) Ports Three USB 3.0 (one Always On), MiniDP, HDMI, Ethernet (RJ-45), Dock connector								
	i5-6300U	2	4	2.4 GHz	3 GHz	3MB	DDR3L-1600	Intel HD Graphics 520	Camera (<i>optional</i>) HD720p resolution, low light sensitive, fixed focus								
	i7-6500U			2.5 GHz	3.1 GHz	4MB			Audio support HD Audio, Realtek® ALC3245 codec / stereo speakers, 1W x 2 / dual array microphone, combo audio/microphone jack								
i7-6600U	2.6 GHz			3.4 GHz	4MB												
Graphics	Intel HD Graphics 520 in processor and NVIDIA Quadro® M500M (2GB memory); supports external digital monitor via HDMI or Mini DisplayPort; supports three independent displays; Max resolution: 3840x2160@60Hz (DisplayPort via Mini DisplayPort cable); 4096x2160@24Hz (HDMI)								Keyboard 6-row, spill-resistant, multimedia Fn keys, numeric keypad, optional LED backlight UltraNav™ TrackPoint® pointing device and buttonless Mylar surface touchpad, multi-touch								
Chipset	Intel SoC (System on Chip) platform								Security Power-on password, hard disk password, supervisor password, security keyhole								
Memory	32GB max ⁷ / PC3-12800 1600MHz DDR3L, non-parity, dual-channel capable, two DDR3L SO-DIMM sockets								Security chip Discrete TPM 1.2 TCG Certified and Firmware TPM 2.0 integrated in chipset								
Display	<i>Some</i> : 15.6" (396mm) FHD (1920x1080), anti-glare, LED backlight, IPS, 250 nits, 16:9 aspect ratio, 400:1 or 500:1 contrast ratio, 160° viewing angle								ThinkEngine Delivers improved thermal and power efficiency, up to 30 day standby, faster resume time, enhanced security, as well as anti-tampering measures								
	<i>Some</i> : 15.5" (394mm) 3K (2880x1620), anti-glare, LED backlight, IPS, 350 nits, 16:9 aspect ratio, 1000:1 contrast ratio, 160° viewing angle								vPro (<i>optional</i>) Intel vPro Technology								
Multi-touch (<i>opt</i>)	In-cell touch, supports 10-finger gesture								Fingerprint reader <i>Optional</i> : Swipe style fingerprint reader on the palm rest								
Storage	<i>Some</i> : SSD / SATA 6.0Gb/s (e.g. xxxG SSD)								Internal battery <i>Optional</i> : Integrated Li-Polymer 3-cell (44Wh)								
	<i>Some</i> : SSD / PCIe NVMe, PCIe 3.0 x 2, 16Gb/s (e.g. xxxG SSD PCIe NVMe) <i>Some</i> : HDD / SATA 6.0Gb/s, 2.5" wide, 7mm high, Shock Mounted Hard Drive, Active Protection System™ <i>Some</i> : SSHD with 8GB NAND flash memory								External battery Li-Ion or Li-Polymer 3-cell (23Wh) or Li-Ion 6-cell (48Wh or 72Wh)								
Optical	None								Max battery life ¹⁰ (MobileMark® 2014)								
Ethernet	<i>Non-vPro model</i> : Intel Ethernet Connection I219-V (Jacksonville) <i>vPro model</i> : Intel Ethernet Connection I219-LM (Jacksonville)								<table border="1"> <thead> <tr> <th>Models</th> <th>3 + 3-cell</th> <th>3 + 6-cell 48Wh</th> <th>3 + 6-cell 72Wh</th> </tr> </thead> <tbody> <tr> <td>Max battery life</td> <td>12.0 hr</td> <td>16.3 hr</td> <td>20.5 hr</td> </tr> </tbody> </table>	Models	3 + 3-cell	3 + 6-cell 48Wh	3 + 6-cell 72Wh	Max battery life	12.0 hr	16.3 hr	20.5 hr
Models	3 + 3-cell	3 + 6-cell 48Wh	3 + 6-cell 72Wh														
Max battery life	12.0 hr	16.3 hr	20.5 hr														
WLAN ⁴	<i>One of the following, configurable by model:</i> • 11ac+BT, Broadcom BCM4356, 2x2, M.2 card • 11ac+BT, Intel Dual Band Wireless-AC 8260, 2x2, M.2 card								AC adapter 65W Slim AC adapter or 65W AC adapter								
Bluetooth™	Bluetooth 4.1 wireless, integrated in Wi-Fi + Bluetooth combo adapter								Preload Windows 7 Professional 64 preinstalled through downgrade rights in Windows 10 Pro 64 • Lenovo Solution Center • Lenovo Companion • Lenovo Setting • ThinkVantage Product Recovery • Rescue and Recovery™ • ThinkVantage System Update • Adobe® Reader® • Microsoft® Office preloaded; purchase a product key to activate • McAfee® LiveSafe™ (30-day trial) <i>For ISV certifications, please visit www.lenovo.com/support/ISV</i>								
WWAN (<i>optional</i>)	<i>One of the following, configurable by model:</i> • Wireless WAN upgradable • Wireless WAN, Sierra Wireless EM7455, Qualcomm® 4G LTE-Advanced/DC-HSPA+/HSPA+/HSPA/UMTS/GNSS, M.2 card • Wireless WAN, HUAWEI ME906S, HUAWEI 4G LTE/WCDMA/HSPA/GSM/GPRS/EDGE/GNSS, M.2 card (WE only)								Limited warranty ¹² <i>One of the following, configurable by model:</i> • 3-year/1-yr battery depot repair service • 3-year/1-yr battery limited onsite service ²⁴ • 3-year/1-yr battery limited onsite service, OID (Onsite International Delivery)								
SIM card (<i>opt</i>)	Micro-SIM card slot, optional Verizon LTE (US) or Lenovo Connect (WE) SIM card								Mil-Spec test MIL-STD-810G military certification								
Dimensions ³ Weight ²	WxDxH: 14.98" x 10.17" x 0.88"; 380.6mm x 258.2mm x 22.45mm								Environment EPEAT™ Gold (US only); ENERGY STAR® 6.1; GREENGUARD®; RoHS-compliant								
	Models	No + 6-cell		3-cell + 3-cell		3-cell + 6-cell											
	Non-touch	5.27 lb / 2.39 kg		4.97 lb / 2.25 kg		5.44 lb / 2.47 kg											
	Multi-touch	-		5.00 lb / 2.27 kg		5.42 lb / 2.46 kg											
Case material	<i>Display cover</i> : PPS; <i>Bottom</i> : Glass-Fiber Reinforced Plastic																

ThinkPad P50s - TopSeller - 20FL

Product Specifications Reference (PSREF)

Model	Region	Processor	vPro	Graphics	Memory	Display	Multi-touch	Storage(HDD/SSD)	Optical	WLAN + Bluetooth	WWAN	SIM Card	Smart Card Reader	Camera	Keyboard	Fingerprint Reader	Battery (internal+external)	Power Adapter	Operating System	Warranty	Ann Date (m/y)
20FL000GUS	US	i7-6500U	No	M500M 2GB	8GBx2	15.6" FHD (1920x1080) IPS	None	256GB SSD Opal2	None	Intel 8260 ac, 2x2 + BT4.1	WWAN Upgradable	None	None	720p	Backlit	Fingerprint Reader	3-cell(44Wh) + 3-cell(23Wh)	65W	Win10 DG Win7 Pro 64	3-year, Depot	01/16
20FL000HUS	US	i5-6300U	vPro	M500M 2GB	8GBx1	15.6" FHD (1920x1080) IPS	None	256GB SSD Opal2	None	Intel 8260 ac, 2x2 + BT4.1	WWAN Upgradable	None	None	720p	Backlit	Fingerprint Reader	None + 6-cell(72Wh)	65W	Win10 DG Win7 Pro 64	3-year, Depot	01/16
20FL000JUS	US	i7-6500U	No	M500M 2GB	8GBx1	15.5" 3K (2880x1620) IPS	None	256GB SSD Opal2	None	Intel 8260 ac, 2x2 + BT4.1	WWAN Upgradable	None	None	720p	Backlit	Fingerprint Reader	3-cell(44Wh) + 3-cell(23Wh)	65W	Win10 DG Win7 Pro 64	3-year, Depot	01/16
20FL000KUS	US	i7-6500U	No	M500M 2GB	8GBx1	15.6" FHD (1920x1080) IPS	None	500GB 7200rpm	None	Intel 8260 ac, 2x2 + BT4.1	WWAN Upgradable	None	None	720p	Backlit	Fingerprint Reader	3-cell(44Wh) + 3-cell(23Wh)	65W	Win10 DG Win7 Pro 64	3-year, Depot	01/16
20FL000LUS	US	i7-6500U	No	M500M 2GB	8GBx1	15.6" FHD (1920x1080) IPS	None	1TB 5400rpm	None	Intel 8260 ac, 2x2 + BT4.1	WWAN Upgradable	None	None	720p	Backlit	Fingerprint Reader	None + 6-cell(48Wh)	65W	Win10 DG Win7 Pro 64	3-year, Depot	01/16
20FL000MUS	US	i7-6500U	No	M500M 2GB	8GBx2	15.6" FHD (1920x1080) IPS	None	512GB SSD	None	Intel 8260 ac, 2x2 + BT4.1	WWAN Upgradable	None	None	720p	Backlit	Fingerprint Reader	3-cell(44Wh) + 3-cell(23Wh)	65W	Win10 DG Win7 Pro 64	3-year, Depot	01/16
20FL000NUS	US	i7-6600U	vPro	M500M 2GB	8GBx2	15.5" 3K (2880x1620) IPS	None	512GB SSD	None	Intel 8260 ac, 2x2 + BT4.1	WWAN Upgradable	None	None	720p	Backlit	Fingerprint Reader	3-cell(44Wh) + 3-cell(23Wh)	65W	Win10 DG Win7 Pro 64	3-year, Depot	01/16
20FL0014US	US	i5-6300U	vPro	M500M 2GB	8GBx1	15.6" FHD (1920x1080) IPS	None	256GB SSD Opal2	None	Intel 8260 ac, 2x2 + BT4.1	WWAN Upgradable	None	None	720p	Backlit	None	3-cell(44Wh) + 6-cell(72Wh)	65W	Win10 Pro 64	3-year, Depot	08/16
20FL0015US	US	i7-6500U	No	M500M 2GB	8GBx1	15.6" FHD (1920x1080) IPS	None	1TB 5400rpm	None	Intel 8260 ac, 2x2 + BT4.1	WWAN Upgradable	None	None	720p	Backlit	None	3-cell(44Wh) + 6-cell(72Wh)	65W	Win10 Pro 64	3-year, Depot	08/16
20FL0016US	US	i7-6500U	No	M500M 2GB	8GBx1	15.5" 3K (2880x1620) IPS	None	256GB SSD Opal2	None	Intel 8260 ac, 2x2 + BT4.1	WWAN Upgradable	None	None	720p	Backlit	None	3-cell(44Wh) + 6-cell(72Wh)	65W	Win10 Pro 64	3-year, Depot	08/16
20FL0017US	US	i7-6500U	No	M500M 2GB	8GBx1	15.6" FHD (1920x1080) IPS	None	256GB SSD Opal2	None	Intel 8260 ac, 2x2 + BT4.1	WWAN Upgradable	None	None	720p	Backlit	None	3-cell(44Wh) + 6-cell(72Wh)	65W	Win10 Pro 64	3-year, Depot	08/16
20FL0018US	US	i7-6500U	No	M500M 2GB	8GBx1	15.6" FHD (1920x1080) IPS	None	512GB SSD	None	Intel 8260 ac, 2x2 + BT4.1	WWAN Upgradable	None	None	720p	Backlit	None	3-cell(44Wh) + 6-cell(72Wh)	65W	Win10 Pro 64	3-year, Depot	08/16
20FL0019US	US	i7-6500U	No	M500M 2GB	8GBx1	15.6" FHD (1920x1080) IPS	None	500GB 7200rpm	None	Intel 8260 ac, 2x2 + BT4.1	WWAN Upgradable	None	None	720p	Backlit	None	3-cell(44Wh) + 6-cell(72Wh)	65W	Win10 Pro 64	3-year, Depot	08/16
20FL001AUS	US	i7-6600U	vPro	M500M 2GB	8GBx1	15.6" FHD (1920x1080) IPS	None	512GB SSD	None	Intel 8260 ac, 2x2 + BT4.1	WWAN Upgradable	None	None	720p	Backlit	None	3-cell(44Wh) + 6-cell(72Wh)	65W	Win10 Pro 64	3-year, Depot	08/16
20FL001BUS	US	i7-6500U	No	M500M 2GB	16GBx1	15.5" 3K (2880x1620) IPS	None	1TB 5400rpm	None	Intel 8260 ac, 2x2 + BT4.1	WWAN Upgradable	None	None	720p	Backlit	None	3-cell(44Wh) + 6-cell(72Wh)	65W	Win10 Pro 64	3-year, Depot	08/16



ThinkPad P70 Platform Specifications

Product Specifications Reference (PSREF)

<p>Processor</p> <table border="1" data-bbox="262 178 1039 373"> <thead> <tr> <th>Processor Number</th> <th># of Cores</th> <th># of Threads</th> <th>Base Frequency</th> <th>Max Turbo Frequency</th> <th>Cache</th> <th>Memory Types</th> <th>Processor Graphics</th> </tr> </thead> <tbody> <tr> <td>i7-6700HQ</td> <td rowspan="4">4</td> <td rowspan="4">8</td> <td>2.6 GHz</td> <td>3.5 GHz</td> <td>6MB</td> <td rowspan="4">DDR4-2133</td> <td>Intel HD Graphics 530</td> </tr> <tr> <td>i7-6820HQ</td> <td>2.7 GHz</td> <td>3.6 GHz</td> <td>8MB</td> <td>Intel HD Graphics P530</td> </tr> <tr> <td>E3-1505M v5</td> <td>2.8 GHz</td> <td>3.7 GHz</td> <td rowspan="2">8MB</td> <td rowspan="2">Intel Iris™ Pro Graphics P580</td> </tr> <tr> <td>E3-1575M v5</td> <td>3 GHz</td> <td>3.9 GHz</td> </tr> </tbody> </table>	Processor Number	# of Cores	# of Threads	Base Frequency	Max Turbo Frequency	Cache	Memory Types	Processor Graphics	i7-6700HQ	4	8	2.6 GHz	3.5 GHz	6MB	DDR4-2133	Intel HD Graphics 530	i7-6820HQ	2.7 GHz	3.6 GHz	8MB	Intel HD Graphics P530	E3-1505M v5	2.8 GHz	3.7 GHz	8MB	Intel Iris™ Pro Graphics P580	E3-1575M v5	3 GHz	3.9 GHz	<p>Smart card reader <i>Optional</i>: Smart card reader</p> <p>ExpressCard One slot (ExpressCard/34)</p> <p>Media reader 4-in-1 reader (MMC, SD, SDHC, SDXC), supports UHS-II SD card</p> <p>Ports Four USB 3.0 (one Always On), two USB Type-C / Thunderbolt 3, Mini DisplayPort, HDMI, Ethernet (RJ-45), Dock connector</p> <p>Camera <i>(optional)</i> HD720p resolution, low light sensitive, fixed focus</p> <p>Audio support HD Audio, Realtek® ALC3268 codec / stereo speakers, 2W x 2 / dual array microphone, combo audio/microphone jack</p>
Processor Number	# of Cores	# of Threads	Base Frequency	Max Turbo Frequency	Cache	Memory Types	Processor Graphics																							
i7-6700HQ	4	8	2.6 GHz	3.5 GHz	6MB	DDR4-2133	Intel HD Graphics 530																							
i7-6820HQ			2.7 GHz	3.6 GHz	8MB		Intel HD Graphics P530																							
E3-1505M v5			2.8 GHz	3.7 GHz	8MB		Intel Iris™ Pro Graphics P580																							
E3-1575M v5			3 GHz	3.9 GHz																										
<p>Graphics</p>	<p>Intel HD Graphics 530, Intel HD Graphics P530, or Intel Iris™ Pro Graphics P580 in processor and NVIDIA Quadro® M600M (2GB memory), M3000M (4GB memory), M4000M (4GB memory), or M5000M (8GB memory); supports external digital monitor via HDMI, Mini DisplayPort, or Thunderbolt™; supports five independent displays; Max resolution: 3840x2160@60Hz (DisplayPort via Mini DisplayPort cable); 3840x2160@60Hz (Thunderbolt); 3840x2160@30Hz (HDMI)</p>	<p>Keyboard 6-row, spill-resistant, multimedia Fn keys, numeric keypad, optional LED backlight</p> <p>UltraNav™ 3-button TrackPoint® pointing device and 3-button crystal silk surface multi-touch touchpad</p> <p>Security Power-on password, hard disk password, supervisor password, security keyhole</p> <p>Security chip Discrete TPM 1.2 TCG Certified and Firmware TPM 2.0 integrated in chipset</p> <p>ThinkEngine Delivers improved thermal and power efficiency, up to 30 day standby, faster resume time, enhanced security, as well as anti-tampering measures</p> <p>vPro <i>(optional)</i> Intel vPro Technology</p> <p>Fingerprint reader Touch style fingerprint reader on the keyboard bezel</p> <p>Color calibration <i>Optional</i>: Pantone® color calibrator by X-Rite® color calibration sensor in palm rest</p>																												
<p>Chipset</p>	<p>Mobile Intel CM236 Chipset (Intel GL82CM236 PCH)</p>	<p>Battery Li-Ion 8-cell (96Wh)</p> <p>Max battery life¹⁰ <i>(MobileMark® 2014)</i></p> <table border="1" data-bbox="1365 592 1732 649"> <thead> <tr> <th>Mode</th> <th>Discrete Graphics</th> <th>Hybrid Graphics</th> </tr> </thead> <tbody> <tr> <td>Max battery life</td> <td>8.5 hr</td> <td>10.8 hr</td> </tr> </tbody> </table>	Mode	Discrete Graphics	Hybrid Graphics	Max battery life	8.5 hr	10.8 hr																						
Mode	Discrete Graphics	Hybrid Graphics																												
Max battery life	8.5 hr	10.8 hr																												
<p>Memory</p>	<p>64GB max⁷ / 2133MHz DDR4, ECC or non-ECC (ECC function supported only on Xeon processor), dual-channel capable, four DDR4 SO-DIMM sockets</p>	<p>AC adapter 170W or 230W AC adapter</p>																												
<p>Display</p>	<p><i>Some</i>: 17.3" (439mm) FHD (1920x1080), anti-glare, LED backlight, IPS, 300 nits, 16:9 aspect ratio, 800:1 contrast ratio, 72% gamut, 170° viewing angle</p> <p><i>Some</i>: 17.3" (439mm) 4K (3840x2160), anti-glare, LED backlight, IPS, 300 nits, 16:9 aspect ratio, 800:1 contrast ratio, 90% gamut, 170° viewing angle</p>	<p>Preload <i>Some</i>: Genuine Windows® 7 Professional 64</p> <p><i>Some</i>: Windows 7 Professional 64 preinstalled through downgrade rights in Windows 10 Pro 64</p> <ul style="list-style-type: none"> • Lenovo Solution Center • Lenovo SHAREit • ThinkVantage Product Recovery • Rescue and Recovery™ • ThinkVantage System Update • Adobe® Reader® • Microsoft® Office preloaded; purchase a product key to activate • McAfee® LiveSafe™ (30-day trial) <p><i>For ISV certifications, please visit www.lenovo.com/support/ISV</i></p>																												
<p>Multi-touch <i>(opt)</i></p> <p>Pen <i>(optional)</i></p>	<p>Capacitive-type multi-touch, supports 10-finger gesture, 270 nits</p> <p>ThinkPad Pen Pro, active pen for multi-touch display</p>	<p>Limited warranty¹² <i>One of the following, configurable by model:</i></p> <ul style="list-style-type: none"> • 3-year/1-yr battery depot repair service • 3-year/1-yr battery limited onsite service²⁴ • 3-year/1-yr battery limited onsite service, OID (Onsite International Delivery) 																												
<p>Storage</p>	<p>Up to 4 drives (two M.2 SSD and two HDD, one of which is in the optical bay)</p> <p><i>Some</i>: M.2 SSD / SATA 6.0Gb/s (e.g. xxxG SSD)</p> <p><i>Some</i>: M.2 SSD / PCIe NVMe, PCIe 3.0 x 4, 32Gb/s (e.g. xxxG SSD PCIe NVMe)</p> <p><i>Some</i>: HDD / SATA 6.0Gb/s, 2.5" wide, 7mm high, Shock Mounted Hard Drive, Active Protection System™</p>	<p>Mil-Spec test MIL-STD-810G military certification</p>																												
<p>Optical <i>(optional)</i></p>	<p>DVD burner, 9.5mm high, fixed, tray-in</p>	<p>Environment EPEAT™ Gold (US only); ENERGY STAR® 6.1; GREENGUARD®; RoHS-compliant</p>																												
<p>Ethernet</p>	<p><i>Non-vPro model</i>: Intel Ethernet Connection I219-V (Jacksonville)</p> <p><i>vPro model</i>: Intel Ethernet Connection I219-LM (Jacksonville)</p>																													
<p>WLAN⁴</p>	<p>11ac+BT, Intel Dual Band Wireless-AC 8260, 2x2, M.2 card</p>																													
<p>Bluetooth™</p>	<p>Bluetooth 4.1 wireless, integrated in Wi-Fi + Bluetooth combo adapter</p>																													
<p>WWAN <i>(optional)</i></p>	<p>Wireless WAN, Sierra Wireless EM7455, Qualcomm® 4G LTE-Advanced/DC-HSPA+/HSPA+/HSPA/UMTS/GNSS, M.2 card</p>																													
<p>SIM card</p>	<p>Micro-SIM card slot</p>																													
<p>Dimensions³</p>	<p><i>WxDxH</i>: 16.38" x 10.85" x 1.18-1.35"; 416mm x 275.5mm x 29.9-34.2mm</p> <p><i>WxDxH(Touch)</i>: 16.38" x 10.85" x 1.20-1.37"; 416mm x 275.5mm x 30.6-34.9mm</p>																													
<p>Weight²</p>	<p><i>Non-touch model</i>: from 7.3 lb (3.3kg);</p> <p><i>Multi-touch model</i>: from 8.1 lb (3.7kg)</p>																													
<p>Case material</p>	<p><i>Display cover</i>: Glass-Fiber + PPS;</p> <p><i>Bottom</i>: Magnesium/Aluminum</p>																													

Model	Region	Processor	vPro	Graphics	Memory	Display	Multi-touch	Pen	Storage(HDD/SSD)	RAID	Optical	WLAN + Bluetooth	WWAN	SIM Card	Smart Card Reader	Camera	Keyboard	Fingerprint Reader	Color Calibrator	Battery	Power Adapter	Operating System	Warranty	Ann Date (m/y)
20ER000FUS	US	i7-6700HQ	No	M600M 2GB	8GBx1 non-ECC	17.3" FHD (1920x1080) IPS	None	None	500GB 7200rpm	No	DVD±RW	Intel 8260 ac, 2x2 + BT4.1	None	None	None	720p	Backlit	Fingerprint Reader	None	8-cell (96Wh)	170W	Win10 DG Win7 Pro 64	3-year, Depot	10/15
20ER000GUS	US	i7-6700HQ	No	M3000M 4GB	8GBx1 non-ECC	17.3" FHD (1920x1080) IPS	None	None	500GB 7200rpm	No	DVD±RW	Intel 8260 ac, 2x2 + BT4.1	None	None	None	720p	Backlit	Fingerprint Reader	None	8-cell (96Wh)	230W	Win10 DG Win7 Pro 64	3-year, Depot	10/15
20ER000HUS	US	i7-6820HQ	vPro	M600M 2GB	8GBx1 non-ECC	17.3" FHD (1920x1080) IPS	None	None	500GB 7200rpm	No	DVD±RW	Intel 8260 ac, 2x2 + BT4.1	None	None	None	720p	Backlit	Fingerprint Reader	None	8-cell (96Wh)	170W	Win10 DG Win7 Pro 64	3-year, Depot	10/15
20ER000JUS	US	i7-6820HQ	vPro	M3000M 4GB	8GBx1 non-ECC	17.3" FHD (1920x1080) IPS	None	None	500GB 7200rpm	No	DVD±RW	Intel 8260 ac, 2x2 + BT4.1	None	None	None	720p	Backlit	Fingerprint Reader	None	8-cell (96Wh)	230W	Win10 DG Win7 Pro 64	3-year, Depot	10/15
20ER000KUS	US	i7-6820HQ	vPro	M3000M 4GB	8GBx1 non-ECC	17.3" FHD (1920x1080) IPS	10-point Multi-touch	ThinkPad Pen Pro	256GB SSD M.2 Opal2	No	DVD±RW	Intel 8260 ac, 2x2 + BT4.1	None	None	None	720p	Backlit	Fingerprint Reader	X-Rite	8-cell (96Wh)	230W	Win10 DG Win7 Pro 64	3-year, Depot	10/15
20ER000LUS	US	Xeon E3-1505M v5	vPro	M600M 2GB	8GBx1 ECC	17.3" FHD (1920x1080) IPS	None	None	256GB SSD M.2 PCIe NVMe Opal2	No	DVD±RW	Intel 8260 ac, 2x2 + BT4.1	None	None	None	720p	Backlit	Fingerprint Reader	None	8-cell (96Wh)	170W	Win10 DG Win7 Pro 64	3-year, Depot	11/15
20ER000MUS	US	Xeon E3-1505M v5	vPro	M3000M 4GB	8GBx1 ECC	17.3" FHD (1920x1080) IPS	None	None	256GB SSD M.2 PCIe NVMe Opal2	No	DVD±RW	Intel 8260 ac, 2x2 + BT4.1	None	None	None	720p	Backlit	Fingerprint Reader	None	8-cell (96Wh)	230W	Win10 DG Win7 Pro 64	3-year, Depot	11/15
20ER000NUS	US	Xeon E3-1505M v5	vPro	M3000M 4GB	16GBx1 ECC	17.3" 4K (3840x2160) IPS	None	None	512GB SSD M.2 PCIe NVMe	No	DVD±RW	Intel 8260 ac, 2x2 + BT4.1	None	None	Smart Card Reader	720p	Backlit	Fingerprint Reader	X-Rite	8-cell (96Wh)	230W	Win10 DG Win7 Pro 64	3-year, Depot	11/15
20ER000PUS	US	i7-6820HQ	vPro	M600M 2GB	8GBx1 non-ECC	17.3" FHD (1920x1080) IPS	10-point Multi-touch	ThinkPad Pen Pro	500GB 7200rpm	No	DVD±RW	Intel 8260 ac, 2x2 + BT4.1	None	None	None	720p	Backlit	Fingerprint Reader	X-Rite	8-cell (96Wh)	170W	Win10 Pro 64	3-year, Depot	10/15
20ER000QUS	US	i7-6820HQ	vPro	M3000M 4GB	8GBx1 non-ECC	17.3" FHD (1920x1080) IPS	10-point Multi-touch	ThinkPad Pen Pro	256GB SSD M.2 Opal2	No	DVD±RW	Intel 8260 ac, 2x2 + BT4.1	None	None	None	720p	Backlit	Fingerprint Reader	X-Rite	8-cell (96Wh)	230W	Win10 Pro 64	3-year, Depot	10/15
20ER000RUS	US	i7-6820HQ	vPro	M3000M 4GB	16GBx1 non-ECC	17.3" 4K (3840x2160) IPS	None	None	512GB SSD M.2 PCIe NVMe	No	DVD±RW	Intel 8260 ac, 2x2 + BT4.1	None	None	Smart Card Reader	720p	Backlit	Fingerprint Reader	X-Rite	8-cell (96Wh)	230W	Win10 DG Win7 Pro 64	3-year, Depot	11/15
20ER000SUS	US	i7-6820HQ	vPro	M3000M 4GB	8GBx1 non-ECC	17.3" FHD (1920x1080) IPS	None	None	256GB SSD M.2 Opal2	No	DVD±RW	Intel 8260 ac, 2x2 + BT4.1	None	None	None	720p	Backlit	Fingerprint Reader	None	8-cell (96Wh)	230W	Win10 DG Win7 Pro 64	3-year, Depot	10/15
20ER000TUS	US	i7-6700HQ	No	M600M 2GB	8GBx1 non-ECC	17.3" FHD (1920x1080) IPS	None	None	1TB 5400rpm	No	DVD±RW	Intel 8260 ac, 2x2 + BT4.1	None	None	None	720p	Backlit	Fingerprint Reader	None	8-cell (96Wh)	170W	Win10 DG Win7 Pro 64	3-year, Depot	10/15
20ER000UUS	US	i7-6700HQ	No	M3000M 4GB	16GBx1 non-ECC	17.3" FHD (1920x1080) IPS	None	None	256GB SSD M.2 Opal2	No	DVD±RW	Intel 8260 ac, 2x2 + BT4.1	None	None	None	720p	Backlit	Fingerprint Reader	None	8-cell (96Wh)	230W	Win10 DG Win7 Pro 64	3-year, Depot	10/15
20ER000VUS	US	i7-6700HQ	No	M600M 2GB	8GBx1 non-ECC	17.3" FHD (1920x1080) IPS	None	None	500GB 7200rpm	No	Blank Bezel	Intel 8260 ac, 2x2 + BT4.1	None	None	None	720p	Backlit	Fingerprint Reader	None	8-cell (96Wh)	170W	Win10 DG Win7 Pro 64	3-year, Depot	10/15
20ER000WUS	US	i7-6820HQ	vPro	M4000M 4GB	16GBx1 non-ECC	17.3" 4K (3840x2160) IPS	None	None	512GB SSD M.2 PCIe NVMe	No	Blank Bezel	Intel 8260 ac, 2x2 + BT4.1	None	None	Smart Card Reader	720p	Backlit	Fingerprint Reader	X-Rite	8-cell (96Wh)	230W	Win10 DG Win7 Pro 64	3-year, Depot	11/15
20ER000XUS	US	Xeon E3-1505M v5	vPro	M4000M 4GB	16GBx1 ECC	17.3" 4K (3840x2160) IPS	None	None	512GB SSD M.2 PCIe NVMe	No	Blank Bezel	Intel 8260 ac, 2x2 + BT4.1	None	None	Smart Card Reader	720p	Backlit	Fingerprint Reader	X-Rite	8-cell (96Wh)	230W	Win10 DG Win7 Pro 64	3-year, Depot	11/15
20ER000YUS	US	i7-6820HQ	vPro	M3000M 4GB	8GBx1 non-ECC	17.3" FHD (1920x1080) IPS	None	None	1TB 5400rpm	No	DVD±RW	Intel 8260 ac, 2x2 + BT4.1	None	None	None	720p	Backlit	Fingerprint Reader	None	8-cell (96Wh)	230W	Win10 DG Win7 Pro 64	3-year, Depot	10/15
20ER002FUS	US	i7-6700HQ	No	M600M 2GB	8GBx1 non-ECC	17.3" FHD (1920x1080) IPS	None	None	500GB 7200rpm	No	DVD±RW	Intel 8260 ac, 2x2 + BT4.1	None	None	None	720p	Backlit	Fingerprint Reader	X-Rite	8-cell (96Wh)	170W	Win10 Pro 64	3-year, Depot	10/15
20ER002GUS	US	Xeon E3-1505M v5	vPro	M600M 2GB	16GBx1 non-ECC	17.3" FHD (1920x1080) IPS	None	None	256GB SSD M.2 Opal2	No	DVD±RW	Intel 8260 ac, 2x2 + BT4.1	None	None	None	720p	Backlit	Fingerprint Reader	None	8-cell (96Wh)	170W	Win10 DG Win7 Pro 64	3-year, Depot	10/15

Model	Region	Processor	vPro	Graphics	Memory	Display	Multi-touch	Pen	Storage(HDD/SSD)	RAID	Optical	WLAN + Bluetooth	WWAN	SIM Card	Smart Card Reader	Camera	Keyboard	Fingerprint Reader	Color Calibrator	Battery	Power Adapter	Operating System	Warranty	Ann Date (m/y)
20ER002HUS	US	Xeon E3-1505M v5	vPro	M3000M 4GB	16GBx1 non-ECC	17.3" FHD (1920x1080) IPS	None	None	256GB SSD M.2 Opal2	No	DVD±RW	Intel 8260 ac, 2x2 + BT4.1	None	None	None	720p	Backlit	Fingerprint Reader	None	8-cell (96Wh)	230W	Win10 Pro 64	3-year, Depot	10/15
20ER002JUS	US	i7-6820HQ	vPro	M3000M 4GB	16GBx1 non-ECC	17.3" FHD (1920x1080) IPS	None	None	256GB SSD M.2 Opal2	No	DVD±RW	Intel 8260 ac, 2x2 + BT4.1	None	None	None	720p	Backlit	Fingerprint Reader	None	8-cell (96Wh)	230W	Win10 Pro 64	3-year, Depot	10/15
20ER002KUS	US	i7-6700HQ	No	M600M 2GB	16GBx1 non-ECC	17.3" FHD (1920x1080) IPS	None	None	500GB 7200rpm	No	DVD±RW	Intel 8260 ac, 2x2 + BT4.1	None	None	None	720p	Backlit	Fingerprint Reader	None	8-cell (96Wh)	170W	Win10 DG Win7 Pro 64	3-year, Depot	10/15
20ER002LUS	US	i7-6820HQ	vPro	M3000M 4GB	16GBx1 non-ECC	17.3" FHD (1920x1080) IPS	None	None	256GB SSD M.2 Opal2	No	DVD±RW	Intel 8260 ac, 2x2 + BT4.1	None	None	None	720p	Backlit	Fingerprint Reader	None	8-cell (96Wh)	230W	Win10 DG Win7 Pro 64	3-year, Depot	10/15
20ER002MUS	US	Xeon E3-1505M v5	vPro	M3000M 4GB	16GBx1 non-ECC	17.3" FHD (1920x1080) IPS	None	None	256GB SSD M.2 Opal2	No	DVD±RW	Intel 8260 ac, 2x2 + BT4.1	None	None	None	720p	Backlit	Fingerprint Reader	None	8-cell (96Wh)	230W	Win10 DG Win7 Pro 64	3-year, Depot	10/15
20ER002NUS	US	i7-6700HQ	No	M600M 2GB	16GBx1 non-ECC	17.3" FHD (1920x1080) IPS	None	None	500GB 7200rpm	No	DVD±RW	Intel 8260 ac, 2x2 + BT4.1	None	None	None	720p	Backlit	Fingerprint Reader	X-Rite	8-cell (96Wh)	170W	Win10 Pro 64	3-year, Depot	10/15
20ER003KUS	US	Xeon E3-1575M v5	vPro	M3000M 4GB	16GBx2 non-ECC	17.3" FHD (1920x1080) IPS	None	None	1TB SSD M.2 PCIe NVMe	No	Blank Bezel	Intel 8260 ac, 2x2 + BT4.1	None	None	None	720p	Backlit	Fingerprint Reader	X-Rite	8-cell (96Wh)	230W	Win10 Pro 64	3-year, Depot	08/16



ThinkPad T450 Platform Specifications

Product Specifications Reference (PSREF)

Processor	4th Generation Intel® Core™ i3 / i5 or 5th Generation Intel Core i3 / i5 / i7 Processor	Dimensions ³	14.0" (WxDxH): 13.35" x 9.15" x 0.83"; 339mm x 232.5mm x 21mm 14.0" Touch (WxDxH): 13.35" x 9.15" x 0.91"; 339mm x 232.5mm x 23mm																																																	
Graphics	<table border="1"> <thead> <tr> <th>Processor Number</th> <th># of Cores</th> <th># of Threads</th> <th>Base Frequency</th> <th>Max Turbo Frequency</th> <th>Cache</th> <th>Memory Types</th> <th>Processor Graphics</th> </tr> </thead> <tbody> <tr> <td>i3-4030U</td> <td rowspan="8">2</td> <td rowspan="8">4</td> <td>1.9 GHz</td> <td>-</td> <td rowspan="4">3MB</td> <td rowspan="8">DDR3L-1600</td> <td rowspan="4">Intel HD Graphics 4400</td> </tr> <tr> <td>i5-4300U</td> <td>1.9 GHz</td> <td>2.9 GHz</td> </tr> <tr> <td>i3-5010U</td> <td>2.1 GHz</td> <td>-</td> </tr> <tr> <td>i5-5200U</td> <td>2.2 GHz</td> <td>2.7 GHz</td> </tr> <tr> <td>i5-5300U</td> <td>2.3 GHz</td> <td>2.9 GHz</td> <td rowspan="4">3MB</td> <td rowspan="8">Intel HD Graphics 5500</td> </tr> <tr> <td>i7-5500U</td> <td>2.4 GHz</td> <td>3 GHz</td> </tr> <tr> <td rowspan="2">i7-5600U</td> <td>2.6 GHz</td> <td>3.2 GHz</td> <td rowspan="2">4MB</td> </tr> </tbody> </table>	Processor Number	# of Cores	# of Threads	Base Frequency	Max Turbo Frequency	Cache	Memory Types	Processor Graphics	i3-4030U	2	4	1.9 GHz	-	3MB	DDR3L-1600	Intel HD Graphics 4400	i5-4300U	1.9 GHz	2.9 GHz	i3-5010U	2.1 GHz	-	i5-5200U	2.2 GHz	2.7 GHz	i5-5300U	2.3 GHz	2.9 GHz	3MB	Intel HD Graphics 5500	i7-5500U	2.4 GHz	3 GHz	i7-5600U	2.6 GHz	3.2 GHz	4MB	Weight ²	<table border="1"> <thead> <tr> <th>Models</th> <th>No + 3-cell</th> <th>3-cell + 3-cell</th> <th>3-cell + 6-cell</th> </tr> </thead> <tbody> <tr> <td>Non-touch</td> <td>3.58 lb / 1.63 kg</td> <td>3.81 lb / 1.73 kg</td> <td>4.21 lb / 1.91 kg</td> </tr> <tr> <td>Multi-touch</td> <td>3.89 lb / 1.76 kg</td> <td>4.11 lb / 1.87 kg</td> <td>4.52 lb / 2.05 kg</td> </tr> </tbody> </table>	Models	No + 3-cell	3-cell + 3-cell	3-cell + 6-cell	Non-touch	3.58 lb / 1.63 kg	3.81 lb / 1.73 kg	4.21 lb / 1.91 kg	Multi-touch	3.89 lb / 1.76 kg	4.11 lb / 1.87 kg	4.52 lb / 2.05 kg
Processor Number	# of Cores	# of Threads	Base Frequency	Max Turbo Frequency	Cache	Memory Types	Processor Graphics																																													
i3-4030U	2	4	1.9 GHz	-	3MB	DDR3L-1600	Intel HD Graphics 4400																																													
i5-4300U			1.9 GHz	2.9 GHz																																																
i3-5010U			2.1 GHz	-																																																
i5-5200U			2.2 GHz	2.7 GHz																																																
i5-5300U			2.3 GHz	2.9 GHz	3MB		Intel HD Graphics 5500																																													
i7-5500U			2.4 GHz	3 GHz																																																
i7-5600U			2.6 GHz	3.2 GHz				4MB																																												
			Models	No + 3-cell					3-cell + 3-cell	3-cell + 6-cell																																										
Non-touch	3.58 lb / 1.63 kg	3.81 lb / 1.73 kg	4.21 lb / 1.91 kg																																																	
Multi-touch	3.89 lb / 1.76 kg	4.11 lb / 1.87 kg	4.52 lb / 2.05 kg																																																	
Chipset	Intel SoC (System on Chip) platform	Case material	Display cover: Glass-Fiber Reinforced Plastic (non-touch model) or Carbon-Fiber Reinforced Plastic (multi-touch model); Bottom: Glass-Fiber Reinforced Plastic																																																	
Memory	16GB max ⁷ / PC3-12800 1600MHz DDR3L, non-parity, dual-channel capable, two 204-pin SO-DIMM sockets	Smart card reader	Optional: Smart card reader																																																	
Display	<p>Intel HD Graphics 4400 or 5500 in processor, supports external analog monitor via VGA and digital monitor via Mini DisplayPort; supports three independent displays; Max resolution: 3840x2160@60Hz (DP via mDP cable); 1920x1200@60Hz (VGA)</p> <p><i>Some:</i> 14.0" (355mm) HD (1366x768), anti-glare, LED backlight, 200 nits, 16:9 aspect ratio, 350:1 contrast ratio</p> <p><i>Some:</i> 14.0" (355mm) HD+ (1600x900), anti-glare, LED backlight, 250 nits, 16:9 aspect ratio, 400:1 contrast ratio</p> <p><i>Some:</i> 14.0" (355mm) FHD (1920x1080), anti-glare, LED backlight, 300 nits, 16:9 aspect ratio, 700:1 contrast ratio, IPS</p>	Media reader	4-in-1 reader (MMC, SD, SDHC, SDXC)																																																	
Multi-touch (opt)	Capacitive-type multi-touch, supports 10-finger gesture, 212.5 nits	Ports	Three USB 3.0 (one Always On), VGA, Mini DisplayPort, Ethernet (RJ-45), Dock connector (integrated models only)																																																	
Storage	<p><i>Some:</i> SSD / SATA 6.0Gb/s, 2.5" wide, 7mm high, removable, upgradable</p> <p><i>Some:</i> HDD / SATA 6.0Gb/s, 2.5" wide, 7mm or 9.5mm high, removable, upgradable, Shock Mounted Hard Drive, Active Protection System™</p> <p><i>Some:</i> SSHD with 8GB NAND flash memory</p>	Camera	HD720p resolution, low light sensitive, fixed focus																																																	
M.2 SSD (opt)	Single-sided M.2 SSD, via M.2 card slot	Audio support	HD Audio, Realtek® ALC3232 codec / stereo speakers, 1W x 2 / dual array microphone, combo audio/microphone jack																																																	
Optical	None	Keyboard	6-row, spill-resistant, multimedia Fn keys, optional LED backlight																																																	
Ethernet	<p><i>Non-vPro model:</i> Intel Ethernet Connection I218-V (Clarkville)</p> <p><i>vPro model:</i> Intel Ethernet Connection I218-LM (Clarkville)</p>	UltraNav™	TrackPoint® pointing device and buttonless Mylar surface touchpad, multi-touch																																																	
Bluetooth™	Bluetooth 4.0 wireless, integrated in Wi-Fi + Bluetooth combo adapter	Security	Power-on password, hard disk password, supervisor password, security keyhole																																																	
WLAN ⁴	<p><i>One of the following, configurable by model:</i></p> <ul style="list-style-type: none"> 11b/g/n, ThinkPad 11b/g/n, 2x2, Wi-Fi + Bluetooth combo adapter, M.2 card 11b/g/n, Intel Wireless-N 7265, 2x2, Wi-Fi + BT, M.2 card (WE only) 11a/b/g/n, Intel Dual Band Wireless-N 7265, 2x2, Wi-Fi + BT, M.2 card (WE only) 11ac, Intel Dual Band Wireless-AC 7265, 2x2, Wi-Fi + BT adapter, M.2 card 	Security chip	Trusted Platform Module, TCG 1.2-compliant																																																	
WWAN (optional)	<p><i>One of the following, configurable by model:</i></p> <ul style="list-style-type: none"> Wireless WAN upgradable Wireless WAN, Ericsson® N5321, HSPA+ 21Mbps/GSM/GPRS/EDGE, GPS, M.2 card (WE only) Wireless WAN, Sierra Wireless EM7345, Intel 4G LTE/HSPA/GSM/GPRS/EDGE, GPS, M.2 card 	ThinkEngine	Delivers improved thermal and power efficiency, up to 30 day standby, faster resume time, enhanced security, as well as anti-tampering measures																																																	
SIM card (opt)	AT&T® or Verizon® LTE (4G), contract required with service provider	vPro (optional)	Intel vPro Technology																																																	
		Fingerprint reader	Optional: Fingerprint reader on the keyboard bezel, swipe sensor																																																	
		Internal battery	Optional: Integrated Li-Ion or Li-Polymer 3-cell (23Wh)																																																	
		External battery	Li-Ion 3-cell (23Wh) or 6-cell (48Wh or 72Wh)																																																	
		Max battery life ¹⁰	<table border="1"> <thead> <tr> <th>Models</th> <th>3-cell + 3-cell</th> <th>3-cell + 6-cell 48Wh</th> <th>3-cell + 6-cell 72Wh</th> </tr> </thead> <tbody> <tr> <td>Battery life</td> <td>10.08 hr</td> <td>14.78 hr</td> <td>19.78 hr</td> </tr> </tbody> </table>	Models	3-cell + 3-cell	3-cell + 6-cell 48Wh	3-cell + 6-cell 72Wh	Battery life	10.08 hr	14.78 hr	19.78 hr																																									
Models	3-cell + 3-cell	3-cell + 6-cell 48Wh	3-cell + 6-cell 72Wh																																																	
Battery life	10.08 hr	14.78 hr	19.78 hr																																																	
		AC adapter	45W AC adapter, 65W Slim AC adapter, or 65W AC adapter																																																	
		Preload	<p>Windows® 7 Professional 64 preinstalled through downgrade rights in Windows 8.1 Pro 64-bit or Windows 10 Pro 64</p> <ul style="list-style-type: none"> Lenovo Solution Center Lenovo SHAREit Lenovo SHAREit Lenovo REACHit Lenovo Companion Microsoft Office preloaded; purchase a product key to activate Norton Internet Security (30 days of virus definitions, Win8 w/o i5/i7 model) McAfee® LiveSafe™ (30-day trial, Win8 i5/i7 and Win10 model) 																																																	
		Limited warranty ¹²	<p><i>One of the following, configurable by model:</i></p> <ul style="list-style-type: none"> 1-year depot repair service 3-year/1-yr battery depot repair service 3-year/1-yr battery limited onsite service²⁴ 3-year/1-yr battery limited onsite service, OID (Onsite International Delivery) 																																																	
		Environment	EPEAT™ Gold (US) or EPEAT Silver (WE); ENERGY STAR® 6.1; GREENGUARD®; RoHS-compliant																																																	

Model	Region	Processor	vPro	Graphics	Memory	Display	Multi-touch	Storage	M.2 SSD	Optical	WLAN + Bluetooth	WWAN	SIM Card	Smart Card Reader	Camera	Keyboard	Fingerprint Reader	Battery (internal+ external)	Power Adapter	Operating System	Warranty	Ann Date (m/y)
20BV0001US	US	i5-5300U	vPro	Intel HD 5500	4GBx1	14" HD+ (1600x900)	None	500GB 7200rpm	16GB SSD	None	Intel 7265 ac, 2x2 + BT4.0	WWAN Upgradable	None	None	720p	Backlit	Fingerprint Reader	3-cell(23Wh) + 3-cell(23Wh)	45W	Win8.1 DG Win7 Pro 64	3-year, Depot	01/15
20BV0002US	US	i5-5300U	vPro	Intel HD 5500	8GBx1	14" HD+ (1600x900)	None	500GB 7200rpm	16GB SSD	None	Intel 7265 ac, 2x2 + BT4.0	WWAN Upgradable	None	None	720p	Backlit	Fingerprint Reader	3-cell(23Wh) + 3-cell(23Wh)	45W	Win8.1 DG Win7 Pro 64	3-year, Depot	01/15
20BV0003US	US	i7-5600U	vPro	Intel HD 5500	8GBx1	14" HD+ (1600x900)	None	500GB 7200rpm	16GB SSD	None	Intel 7265 ac, 2x2 + BT4.0	WWAN Upgradable	None	None	720p	Backlit	Fingerprint Reader	3-cell(23Wh) + 3-cell(23Wh)	45W	Win8.1 DG Win7 Pro 64	3-year, Depot	01/15
20BV0004US	US	i5-4300U	vPro	Intel HD 4400	8GBx1	14" HD (1366x768)	None	256GB SSD Opal2	None	None	Intel 7265 ac, 2x2 + BT4.0	WWAN Upgradable	None	None	720p	Backlit	Fingerprint Reader	3-cell(23Wh) + 3-cell(23Wh)	45W	Win8.1 DG Win7 Pro 64	3-year, Depot	04/15
20BV0005US	US	i5-5200U	No	Intel HD 5500	4GBx1	14" HD (1366x768)	None	500GB 7200rpm	None	None	Intel 7265 ac, 2x2 + BT4.0	WWAN Upgradable	None	None	720p	Non-backlit	Fingerprint Reader	3-cell(23Wh) + 3-cell(23Wh)	45W	Win8.1 DG Win7 Pro 64	1-year, Depot	01/15
20BV0006US	US	i7-5600U	vPro	Intel HD 5500	8GBx1	14" HD+ (1600x900)	10-point Multi-touch	256GB SSD Opal2	None	None	Intel 7265 ac, 2x2 + BT4.0	WWAN Upgradable	None	None	720p	Backlit	Fingerprint Reader	3-cell(23Wh) + 3-cell(23Wh)	45W	Win8.1 Pro 64-bit	3-year, Depot	01/15
20BV0007US	US	i3-5010U	No	Intel HD 5500	4GBx1	14" HD (1366x768)	None	500GB 7200rpm	None	None	11b/g/n, 2x2 + BT4.0	WWAN Upgradable	None	None	720p	Non-backlit	Fingerprint Reader	3-cell(23Wh) + 3-cell(23Wh)	45W	Win8.1 DG Win7 Pro 64	1-year, Depot	01/15
20BV0008US	US	i5-4300U	vPro	Intel HD 4400	8GBx1	14" HD+ (1600x900)	None	500GB 7200rpm	16GB SSD	None	Intel 7265 ac, 2x2 + BT4.0	WWAN Upgradable	None	None	720p	Backlit	Fingerprint Reader	3-cell(23Wh) + 3-cell(23Wh)	45W	Win8.1 DG Win7 Pro 64	3-year, Depot	04/15
20BV0009US	US	i5-5300U	vPro	Intel HD 5500	8GBx1	14" HD+ (1600x900)	None	180GB SSD Opal2	None	None	Intel 7265 ac, 2x2 + BT4.0	WWAN Upgradable	None	None	720p	Backlit	Fingerprint Reader	3-cell(23Wh) + 3-cell(23Wh)	45W	Win8.1 DG Win7 Pro 64	3-year, Depot	01/15
20BV000AUS	US	i5-5300U	vPro	Intel HD 5500	8GBx1	14" HD+ (1600x900)	None	256GB SSD Opal2	None	None	Intel 7265 ac, 2x2 + BT4.0	WWAN Upgradable	None	None	720p	Backlit	Fingerprint Reader	3-cell(23Wh) + 3-cell(23Wh)	45W	Win8.1 DG Win7 Pro 64	3-year, Depot	01/15
20BV000BUS	US	i5-4300U	vPro	Intel HD 4400	4GBx1	14" HD (1366x768)	None	500GB 7200rpm	None	None	Intel 7265 ac, 2x2 + BT4.0	WWAN Upgradable	None	None	720p	Non-backlit	Fingerprint Reader	3-cell(23Wh) + 3-cell(23Wh)	45W	Win8.1 DG Win7 Pro 64	1-year, Depot	04/15
20BV000CUS	US	i5-5300U	vPro	Intel HD 5500	4GBx1	14" HD (1366x768)	None	500GB 7200rpm	None	None	Intel 7265 ac, 2x2 + BT4.0	WWAN Upgradable	None	None	720p	Non-backlit	Fingerprint Reader	3-cell(23Wh) + 3-cell(23Wh)	45W	Win8.1 DG Win7 Pro 64	1-year, Depot	01/15
20BV000DUS	US	i7-5600U	vPro	Intel HD 5500	8GBx1	14" HD+ (1600x900)	None	256GB SSD Opal2	None	None	Intel 7265 ac, 2x2 + BT4.0	WWAN Upgradable	None	None	720p	Backlit	Fingerprint Reader	3-cell(23Wh) + 3-cell(23Wh)	45W	Win8.1 DG Win7 Pro 64	3-year, Depot	01/15
20BV000EUS	US	i5-5300U	vPro	Intel HD 5500	4GBx1	14" HD+ (1600x900)	None	180GB SSD Opal2	None	None	Intel 7265 ac, 2x2 + BT4.0	WWAN Upgradable	None	None	720p	Backlit	Fingerprint Reader	3-cell(23Wh) + 3-cell(23Wh)	45W	Win8.1 DG Win7 Pro 64	3-year, Depot	01/15
20BV000FUS	US	i5-4300U	vPro	Intel HD 4400	4GBx1	14" HD (1366x768)	None	500GB 7200rpm	16GB SSD	None	Intel 7265 ac, 2x2 + BT4.0	WWAN Upgradable	None	None	720p	Non-backlit	Fingerprint Reader	3-cell(23Wh) + 3-cell(23Wh)	45W	Win8.1 DG Win7 Pro 64	3-year, Depot	04/15
20BV000GUS	US	i5-4300U	vPro	Intel HD 4400	8GBx1	14" HD+ (1600x900)	None	256GB SSD Opal2	None	None	Intel 7265 ac, 2x2 + BT4.0	WWAN Upgradable	None	None	720p	Backlit	Fingerprint Reader	3-cell(23Wh) + 3-cell(23Wh)	45W	Win8.1 DG Win7 Pro 64	3-year, Depot	04/15
20BV005EUS	US	i5-5300U	vPro	Intel HD 5500	8GBx1	14" FHD (1920x1080) IPS	None	256GB SSD Opal2	None	None	Intel 7265 ac, 2x2 + BT4.0	WWAN Upgradable	None	None	720p	Backlit	Fingerprint Reader	3-cell(23Wh) + 3-cell(23Wh)	45W	Win10 Pro 64	3-year, Depot	09/15
20BV005FUS	US	i7-5600U	vPro	Intel HD 5500	8GBx1	14" FHD (1920x1080) IPS	None	256GB SSD Opal2	None	None	Intel 7265 ac, 2x2 + BT4.0	WWAN Upgradable	None	None	720p	Backlit	Fingerprint Reader	3-cell(23Wh) + 3-cell(23Wh)	45W	Win10 DG Win7 Pro 64	3-year, Depot	09/15
20BV005GUS	US	i5-5300U	vPro	Intel HD 5500	8GBx1	14" FHD (1920x1080) IPS	None	256GB SSD Opal2	None	None	Intel 7265 ac, 2x2 + BT4.0	WWAN Upgradable	None	None	720p	Backlit	Fingerprint Reader	3-cell(23Wh) + 3-cell(23Wh)	45W	Win10 DG Win7 Pro 64	3-year, Depot	09/15
20BV005HUS	US	i7-5600U	vPro	Intel HD 5500	8GBx2	14" HD+ (1600x900)	10-point Multi-touch	512GB SSD	None	None	Intel 7265 ac, 2x2 + BT4.0	WWAN Upgradable	None	None	720p	Backlit	Fingerprint Reader	3-cell(23Wh) + 3-cell(23Wh)	45W	Win10 DG Win7 Pro 64	3-year, Depot	09/15

Model	Region	Processor	vPro	Graphics	Memory	Display	Multi-touch	Storage	M.2 SSD	Optical	WLAN + Bluetooth	WWAN	SIM Card	Smart Card Reader	Camera	Keyboard	Fingerprint Reader	Battery (internal+external)	Power Adapter	Operating System	Warranty	Ann Date (m/y)
20BV005JUS	US	i5-5300U	vPro	Intel HD 5500	4GBx1	14" HD (1366x768)	None	500GB 7200rpm	None	None	Intel 7265 ac, 2x2 + BT4.0	WWAN Upgradable	None	None	720p	Non-backlit	Fingerprint Reader	3-cell(23Wh) + 3-cell(23Wh)	45W	Win10 Pro 64	1-year, Depot	09/15
20BV005KUS	US	i5-5300U	vPro	Intel HD 5500	4GBx1	14" HD+ (1600x900)	None	500GB 7200rpm	None	None	Intel 7265 ac, 2x2 + BT4.0	WWAN Upgradable	None	None	720p	Backlit	Fingerprint Reader	3-cell(23Wh) + 3-cell(23Wh)	45W	Win10 Pro 64	3-year, Depot	09/15
20BV005LUS	US	i7-5600U	vPro	Intel HD 5500	8GBx2	14" FHD (1920x1080) IPS	None	512GB SSD	None	None	Intel 7265 ac, 2x2 + BT4.0	WWAN Upgradable	None	None	720p	Backlit	Fingerprint Reader	3-cell(23Wh) + 3-cell(23Wh)	45W	Win10 DG Win7 Pro 64	3-year, Depot	09/15
20BV005MUS	US	i5-5200U	No	Intel HD 5500	4GBx1	14" HD (1366x768)	None	500GB 7200rpm	None	None	Intel 7265 ac, 2x2 + BT4.0	WWAN Upgradable	None	None	720p	Non-backlit	Fingerprint Reader	3-cell(23Wh) + 3-cell(23Wh)	45W	Win10 Pro 64	1-year, Depot	09/15
20BV005NUS	US	i5-5300U	vPro	Intel HD 5500	8GBx1	14" HD+ (1600x900)	None	256GB SSD Opal2	None	None	Intel 7265 ac, 2x2 + BT4.0	WWAN Upgradable	None	None	720p	Backlit	Fingerprint Reader	3-cell(23Wh) + 3-cell(23Wh)	45W	Win10 Pro 64	3-year, Depot	09/15
20BV005PUS	US	i7-5600U	vPro	Intel HD 5500	8GBx1	14" FHD (1920x1080) IPS	None	256GB SSD Opal2	None	None	Intel 7265 ac, 2x2 + BT4.0	WWAN Upgradable	None	None	720p	Backlit	Fingerprint Reader	3-cell(23Wh) + 3-cell(23Wh)	45W	Win10 Pro 64	3-year, Depot	09/15
20BV005QUS	US	i7-5600U	vPro	Intel HD 5500	8GBx2	14" FHD (1920x1080) IPS	None	512GB SSD	None	None	Intel 7265 ac, 2x2 + BT4.0	WWAN Upgradable	None	None	720p	Backlit	Fingerprint Reader	3-cell(23Wh) + 3-cell(23Wh)	45W	Win10 Pro 64	3-year, Depot	09/15
20BV005RUS	US	i7-5600U	vPro	Intel HD 5500	8GBx1	14" HD+ (1600x900)	None	256GB SSD Opal2	None	None	Intel 7265 ac, 2x2 + BT4.0	WWAN Upgradable	None	None	720p	Backlit	Fingerprint Reader	3-cell(23Wh) + 3-cell(23Wh)	45W	Win10 Pro 64	3-year, Depot	09/15
20BV005SUS	US	i7-5600U	vPro	Intel HD 5500	8GBx2	14" HD+ (1600x900)	10-point Multi-touch	512GB SSD	None	None	Intel 7265 ac, 2x2 + BT4.0	WWAN Upgradable	None	None	720p	Backlit	Fingerprint Reader	3-cell(23Wh) + 3-cell(23Wh)	45W	Win10 Pro 64	3-year, Depot	09/15
20BV0061US	US	i5-5300U	vPro	Intel HD 5500	4GBx1	14" HD+ (1600x900)	None	500GB 7200rpm	16GB SSD	None	Intel 7265 ac, 2x2 + BT4.0	WWAN Upgradable	None	None	720p	Backlit	Fingerprint Reader	3-cell(23Wh) + 3-cell(23Wh)	45W	Win10 DG Win7 Pro 64	3-year, Depot	09/15
20BV0062US	US	i7-5600U	vPro	Intel HD 5500	8GBx1	14" HD+ (1600x900)	None	256GB SSD Opal2	None	None	Intel 7265 ac, 2x2 + BT4.0	WWAN Upgradable	None	None	720p	Backlit	Fingerprint Reader	3-cell(23Wh) + 3-cell(23Wh)	45W	Win10 DG Win7 Pro 64	3-year, Depot	09/15
20BV0063US	US	i5-5200U	No	Intel HD 5500	4GBx1	14" HD (1366x768)	None	500GB 7200rpm	None	None	Intel 7265 ac, 2x2 + BT4.0	WWAN Upgradable	None	None	720p	Non-backlit	Fingerprint Reader	3-cell(23Wh) + 3-cell(23Wh)	45W	Win10 DG Win7 Pro 64	1-year, Depot	09/15
20BV0064US	US	i5-5300U	vPro	Intel HD 5500	4GBx1	14" HD (1366x768)	None	500GB 7200rpm	None	None	Intel 7265 ac, 2x2 + BT4.0	WWAN Upgradable	None	None	720p	Non-backlit	Fingerprint Reader	3-cell(23Wh) + 3-cell(23Wh)	45W	Win10 DG Win7 Pro 64	1-year, Depot	09/15
20BV0065US	US	i5-5300U	vPro	Intel HD 5500	8GBx1	14" HD+ (1600x900)	None	256GB SSD Opal2	None	None	Intel 7265 ac, 2x2 + BT4.0	WWAN Upgradable	None	None	720p	Backlit	Fingerprint Reader	3-cell(23Wh) + 3-cell(23Wh)	45W	Win10 DG Win7 Pro 64	3-year, Depot	09/15

Model	Region	Processor	vPro	Graphics	Memory	Display	Multi-touch	Storage	M.2 SSD	Optical	WLAN + Bluetooth	WWAN	SIM Card	Smart Card Reader	Camera	Keyboard	Fingerprint Reader	Battery (internal+external)	Power Adapter	Operating System	Warranty	Ann Date (m/y)
20BU0000US	US	i5-5300U	vPro	Intel HD 5500	4GBx1	14" HD+ (1600x900)	None	500GB 7200rpm	None	None	Intel 7265 ac, 2x2 + BT4.0	WWAN Upgradable	None	None	720p	Non-backlit	Fingerprint Reader	None + 6-cell(48Wh)	45W	Win8.1 DG Win7 Pro 64	3-year, Depot	01/15
20BU0001US	US	i7-5600U	vPro	Intel HD 5500	8GBx1	14" HD+ (1600x900)	None	256GB SSD Opal2	None	None	Intel 7265 ac, 2x2 + BT4.0	WWAN Upgradable	None	None	720p	Backlit	Fingerprint Reader	3-cell(23Wh) + 3-cell(23Wh)	45W	Win8.1 DG Win7 Pro 64	3-year, Onsite, OID	01/15
20BU0002US	US	i5-5300U	vPro	Intel HD 5500	4GBx1	14" HD (1366x768)	None	500GB 7200rpm	None	None	Intel 7265 ac, 2x2 + BT4.0	WWAN Upgradable	None	None	720p	Non-backlit	Fingerprint Reader	None + 6-cell(48Wh)	45W	Win8.1 DG Win7 Pro 64	3-year, Onsite, OID	01/15
20BU0003US	US	i5-5300U	vPro	Intel HD 5500	8GBx1	14" HD+ (1600x900)	None	500GB 7200rpm	16GB SSD	None	Intel 7265 ac, 2x2 + BT4.0	WWAN Upgradable	None	None	720p	Backlit	Fingerprint Reader	3-cell(23Wh) + 3-cell(23Wh)	45W	Win8.1 DG Win7 Pro 64	3-year, Onsite, OID	01/15
20BU0004US	US	i5-5300U	vPro	Intel HD 5500	8GBx1	14" HD+ (1600x900)	10-point Multi-touch	256GB SSD Opal2	None	None	Intel 7265 ac, 2x2 + BT4.0	WWAN Upgradable	None	None	720p	Backlit	Fingerprint Reader	3-cell(23Wh) + 3-cell(23Wh)	45W	Win8.1 Pro 64-bit	3-year, Onsite, OID	01/15
20BU0005US	US	i5-5300U	vPro	Intel HD 5500	4GBx1	14" HD+ (1600x900)	None	180GB SSD Opal2	None	None	Intel 7265 ac, 2x2 + BT4.0	WWAN Upgradable	None	None	720p	Backlit	Fingerprint Reader	3-cell(23Wh) + 3-cell(23Wh)	45W	Win8.1 DG Win7 Pro 64	3-year, Onsite, OID	01/15
20BU0006US	US	i5-5300U	vPro	Intel HD 5500	4GBx1	14" HD (1366x768)	None	500GB 7200rpm	None	None	Intel 7265 ac, 2x2 + BT4.0	WWAN Upgradable	None	None	720p	Non-backlit	Fingerprint Reader	None + 6-cell(48Wh)	45W	Win8.1 DG Win7 Pro 64	3-year, Depot	01/15
20BU0007US	US	i7-5600U	vPro	Intel HD 5500	8GBx1	14" HD+ (1600x900)	None	500GB 7200rpm	16GB SSD	None	Intel 7265 ac, 2x2 + BT4.0	WWAN Upgradable	None	None	720p	Backlit	Fingerprint Reader	3-cell(23Wh) + 3-cell(23Wh)	45W	Win8.1 DG Win7 Pro 64	3-year, Onsite, OID	01/15
20BU0008US	US	i5-5300U	vPro	Intel HD 5500	8GBx1	14" HD+ (1600x900)	10-point Multi-touch	256GB SSD Opal2	None	None	Intel 7265 ac, 2x2 + BT4.0	WWAN Upgradable	None	None	720p	Backlit	Fingerprint Reader	3-cell(23Wh) + 3-cell(23Wh)	45W	Win8.1 Pro 64-bit	3-year, Depot	01/15
20BU0009US	US	i5-5300U	vPro	Intel HD 5500	8GBx1	14" HD+ (1600x900)	None	500GB 7200rpm	16GB SSD	None	Intel 7265 ac, 2x2 + BT4.0	WWAN Upgradable	None	None	720p	Backlit	Fingerprint Reader	3-cell(23Wh) + 3-cell(23Wh)	45W	Win8.1 DG Win7 Pro 64	3-year, Depot	01/15
20BU000AUS	US	i5-5300U	vPro	Intel HD 5500	8GBx1	14" HD+ (1600x900)	None	256GB SSD Opal2	None	None	Intel 7265 ac, 2x2 + BT4.0	WWAN Upgradable	None	None	720p	Backlit	Fingerprint Reader	3-cell(23Wh) + 3-cell(23Wh)	45W	Win8.1 DG Win7 Pro 64	3-year, Depot	01/15
20BU000BUS	US	i5-5300U	vPro	Intel HD 5500	4GBx1	14" HD+ (1600x900)	None	500GB 7200rpm	16GB SSD	None	Intel 7265 ac, 2x2 + BT4.0	WWAN Upgradable	None	None	720p	Backlit	Fingerprint Reader	3-cell(23Wh) + 3-cell(23Wh)	45W	Win8.1 DG Win7 Pro 64	3-year, Onsite, OID	01/15
20BU000CUS	US	i5-5300U	vPro	Intel HD 5500	4GBx1	14" HD+ (1600x900)	None	500GB 7200rpm	16GB SSD	None	Intel 7265 ac, 2x2 + BT4.0	WWAN Upgradable	None	None	720p	Backlit	Fingerprint Reader	3-cell(23Wh) + 3-cell(23Wh)	45W	Win8.1 DG Win7 Pro 64	3-year, Depot	01/15
20BU000DUS	US	i7-5600U	vPro	Intel HD 5500	8GBx1	14" HD+ (1600x900)	None	500GB 7200rpm	16GB SSD	None	Intel 7265 ac, 2x2 + BT4.0	WWAN Upgradable	None	None	720p	Backlit	Fingerprint Reader	3-cell(23Wh) + 3-cell(23Wh)	45W	Win8.1 DG Win7 Pro 64	3-year, Depot	01/15
20BU000EUS	US	i5-5300U	vPro	Intel HD 5500	4GBx1	14" HD+ (1600x900)	None	500GB 7200rpm	None	None	Intel 7265 ac, 2x2 + BT4.0	WWAN Upgradable	None	None	720p	Non-backlit	Fingerprint Reader	None + 6-cell(48Wh)	45W	Win8.1 DG Win7 Pro 64	3-year, Onsite, OID	01/15
20BU000FUS	US	i5-5300U	vPro	Intel HD 5500	8GBx1	14" HD+ (1600x900)	None	256GB SSD Opal2	None	None	Intel 7265 ac, 2x2 + BT4.0	WWAN Upgradable	None	None	720p	Backlit	Fingerprint Reader	3-cell(23Wh) + 3-cell(23Wh)	45W	Win8.1 DG Win7 Pro 64	3-year, Onsite, OID	01/15
20BU000GUS	US	i5-5300U	vPro	Intel HD 5500	4GBx1	14" HD+ (1600x900)	None	180GB SSD Opal2	None	None	Intel 7265 ac, 2x2 + BT4.0	WWAN Upgradable	None	None	720p	Backlit	Fingerprint Reader	3-cell(23Wh) + 3-cell(23Wh)	45W	Win8.1 DG Win7 Pro 64	3-year, Depot	01/15
20BU000HUS	US	i7-5600U	vPro	Intel HD 5500	8GBx1	14" HD+ (1600x900)	None	256GB SSD Opal2	None	None	Intel 7265 ac, 2x2 + BT4.0	WWAN Upgradable	None	None	720p	Backlit	Fingerprint Reader	3-cell(23Wh) + 3-cell(23Wh)	45W	Win8.1 DG Win7 Pro 64	3-year, Depot	01/15
20BU00C4US	US	i5-5200U	No	Intel HD 5500	4GBx1	14" HD (1366x768)	None	500GB 7200rpm	None	None	Intel 7265 ac, 2x2 + BT4.0	WWAN Upgradable	None	None	720p	Backlit	Fingerprint Reader	3-cell(23Wh) + 3-cell(23Wh)	45W	Win10 DG Win7 Pro 64	1-year, Depot	08/15
20BU00C5US	US	i5-5300U	vPro	Intel HD 5500	4GBx1	14" HD (1366x768)	None	500GB 7200rpm	None	None	Intel 7265 ac, 2x2 + BT4.0	WWAN Upgradable	None	None	720p	Backlit	Fingerprint Reader	3-cell(23Wh) + 3-cell(23Wh)	45W	Win10 DG Win7 Pro 64	1-year, Depot	08/15

Model	Region	Processor	vPro	Graphics	Memory	Display	Multi-touch	Storage	M.2 SSD	Optical	WLAN + Bluetooth	WWAN	SIM Card	Smart Card Reader	Camera	Keyboard	Fingerprint Reader	Battery (internal+external)	Power Adapter	Operating System	Warranty	Ann Date (m/y)
20BU00C6US	US	i5-5300U	vPro	Intel HD 5500	4GBx1	14" HD+ (1600x900)	None	500GB 7200rpm	16GB SSD	None	Intel 7265 ac, 2x2 + BT4.0	WWAN Upgradable	None	None	720p	Backlit	Fingerprint Reader	3-cell(23Wh) + 3-cell(23Wh)	45W	Win10 DG Win7 Pro 64	3-year, Depot	08/15
20BU00C7US	US	i5-5300U	vPro	Intel HD 5500	8GBx1	14" HD+ (1600x900)	None	256GB SSD Opal2	None	None	Intel 7265 ac, 2x2 + BT4.0	WWAN Upgradable	None	None	720p	Backlit	Fingerprint Reader	3-cell(23Wh) + 3-cell(23Wh)	45W	Win10 DG Win7 Pro 64	3-year, Depot	08/15
20BU00C8US	US	i7-5600U	vPro	Intel HD 5500	8GBx1	14" HD+ (1600x900)	None	256GB SSD Opal2	None	None	Intel 7265 ac, 2x2 + BT4.0	WWAN Upgradable	None	None	720p	Backlit	Fingerprint Reader	3-cell(23Wh) + 3-cell(23Wh)	45W	Win10 DG Win7 Pro 64	3-year, Depot	08/15
20BU00CMUS	US	i7-5600U	vPro	Intel HD 5500	8GBx2	14" HD+ (1600x900)	10-point Multi-touch	512GB SSD	None	None	Intel 7265 ac, 2x2 + BT4.0	WWAN Upgradable	None	None	720p	Backlit	Fingerprint Reader	3-cell(23Wh) + 3-cell(23Wh)	45W	Win10 Pro 64	3-year, Depot	09/15
20BU00CNUS	US	i7-5600U	vPro	Intel HD 5500	8GBx1	14" FHD (1920x1080) IPS	None	256GB SSD Opal2	None	None	Intel 7265 ac, 2x2 + BT4.0	WWAN Upgradable	None	None	720p	Backlit	Fingerprint Reader	3-cell(23Wh) + 3-cell(23Wh)	45W	Win10 Pro 64	3-year, Depot	09/15
20BU00CPUS	US	i7-5600U	vPro	Intel HD 5500	8GBx2	14" HD+ (1600x900)	10-point Multi-touch	512GB SSD	None	None	Intel 7265 ac, 2x2 + BT4.0	WWAN Upgradable	None	None	720p	Backlit	Fingerprint Reader	3-cell(23Wh) + 3-cell(23Wh)	45W	Win10 DG Win7 Pro 64	3-year, Depot	09/15
20BU00CQUS	US	i7-5600U	vPro	Intel HD 5500	4GBx1	14" HD+ (1600x900)	None	256GB SSD Opal2	None	None	Intel 7265 ac, 2x2 + BT4.0	WWAN Upgradable	None	None	720p	Backlit	Fingerprint Reader	3-cell(23Wh) + 3-cell(23Wh)	45W	Win10 Pro 64	3-year, Depot	09/15
20BU00CRUS	US	i7-5600U	vPro	Intel HD 5500	8GBx2	14" FHD (1920x1080) IPS	None	512GB SSD	None	None	Intel 7265 ac, 2x2 + BT4.0	WWAN Upgradable	None	None	720p	Backlit	Fingerprint Reader	3-cell(23Wh) + 3-cell(23Wh)	45W	Win10 DG Win7 Pro 64	3-year, Depot	09/15
20BU00CSUS	US	i7-5600U	vPro	Intel HD 5500	8GBx2	14" FHD (1920x1080) IPS	None	512GB SSD	None	None	Intel 7265 ac, 2x2 + BT4.0	WWAN Upgradable	None	None	720p	Backlit	Fingerprint Reader	3-cell(23Wh) + 3-cell(23Wh)	45W	Win10 Pro 64	3-year, Depot	09/15
20BU00CTUS	US	i7-5600U	vPro	Intel HD 5500	8GBx1	14" FHD (1920x1080) IPS	None	256GB SSD Opal2	None	None	Intel 7265 ac, 2x2 + BT4.0	WWAN Upgradable	None	None	720p	Backlit	Fingerprint Reader	3-cell(23Wh) + 3-cell(23Wh)	45W	Win10 DG Win7 Pro 64	3-year, Depot	09/15
20BU00CUUS	US	i5-5300U	vPro	Intel HD 5500	8GBx1	14" FHD (1920x1080) IPS	None	256GB SSD Opal2	None	None	Intel 7265 ac, 2x2 + BT4.0	WWAN Upgradable	None	None	720p	Backlit	Fingerprint Reader	3-cell(23Wh) + 3-cell(23Wh)	45W	Win10 Pro 64	3-year, Depot	09/15
20BU00CVUS	US	i5-5300U	vPro	Intel HD 5500	4GBx1	14" HD+ (1600x900)	None	256GB SSD Opal2	None	None	Intel 7265 ac, 2x2 + BT4.0	WWAN Upgradable	None	None	720p	Backlit	Fingerprint Reader	3-cell(23Wh) + 3-cell(23Wh)	45W	Win10 Pro 64	3-year, Depot	09/15
20BU00CWUS	US	i5-5300U	vPro	Intel HD 5500	8GBx1	14" FHD (1920x1080) IPS	None	256GB SSD Opal2	None	None	Intel 7265 ac, 2x2 + BT4.0	WWAN Upgradable	None	None	720p	Backlit	Fingerprint Reader	3-cell(23Wh) + 3-cell(23Wh)	45W	Win10 DG Win7 Pro 64	3-year, Depot	09/15



ThinkPad T460 Platform Specifications

Product Specifications Reference (PSREF)

Processor	6th Generation Intel® Core™ i3 / i5 / i7 Processor (i7-6500U for discrete models only)							Smart card reader <i>Optional</i> : Smart card reader																		
	Processor Number	# of Cores	# of Threads	Base Frequency	Max Turbo Frequency	Cache	Memory Types	Processor Graphics	Media reader Ports WiGig dock (<i>opt</i>)																	
	i3-6100U	2	4	2.3 GHz	-	3MB	DDR3L-1600	Intel HD graphics 520	4-in-1 reader (MMC, SD, SDHC, SDXC) Three USB 3.0 (one Always On), MiniDP, HDMI, Ethernet (RJ-45), Dock connector WiGig dock, coexists with WWAN (WE only)																	
	i5-6200U			2.3 GHz	2.8 GHz	3MB																				
	i5-6300U			2.4 GHz	3.0 GHz	3MB																				
	i7-6500U			2.5 GHz	3.1 GHz	4MB																				
	i7-6600U			2.6 GHz	3.4 GHz	4MB																				
Graphics	Intel HD Graphics 520 in processor only, or Intel HD Graphics 520 in processor and NVIDIA GeForce® 940MX, 2GB memory (discrete graphics is only available in US); supports external digital monitor via HDMI or Mini DisplayPort; supports three independent displays; Max resolution: 3840x2160@60Hz (DisplayPort via Mini DisplayPort cable); 1920x1080@60Hz (HDMI)							Camera (<i>optional</i>) Audio support																		
Chipset	Intel SoC (System on Chip) platform							Keyboard UltraNav™																		
Memory	32GB max ⁷ / PC3-12800 1600MHz DDR3L, non-parity, dual-channel capable, two DDR3L SO-DIMM sockets							Security Security chip ThinkEngine																		
Display	<i>Some</i> : 14.0" (355mm) HD (1366x768), anti-glare, LED backlight, 200 nits, 16:9 aspect ratio, 350:1 contrast ratio <i>Some</i> : 14.0" (355mm) FHD (1920x1080), anti-glare, LED backlight, IPS, 250 nits, 16:9 aspect ratio, 700:1 contrast ratio, 160° viewing angle							vPro (<i>optional</i>) Fingerprint reader																		
Multi-touch (<i>opt</i>)	In-cell touch, supports 10-finger gesture, 250 nits							Internal battery External battery Max battery life (<i>MobileMark® 2014</i>)																		
Storage	<i>Some</i> : SSD / SATA 6.0Gb/s (e.g. xxxG SSD) <i>Some</i> : SSD / PCIe NVMe, PCIe 3.0 x 2, 16Gb/s (e.g. xxxG SSD PCIe NVMe) <i>Some</i> : HDD / SATA 6.0Gb/s, 2.5" wide, 7mm or 9.5mm high, Shock Mounted Hard Drive, Active Protection System™ <i>Some</i> : SSHD with 8GB NAND flash memory (WE only)							<i>Optional</i> : Integrated Li-Ion or Li-Polymer 3-cell (23Wh) Li-Ion 3-cell (23Wh) or 6-cell (48Wh or 72Wh)																		
Optical	None							<table border="1"> <thead> <tr> <th>Models</th> <th>6-cell 48Wh</th> <th>6-cell 72Wh</th> <th>3 + 3-cell</th> <th>3 + 6-cell 48Wh</th> <th>3 + 6-cell 72Wh</th> </tr> </thead> <tbody> <tr> <td><i>Integrated model</i></td> <td>10.8 hr</td> <td>15.3 hr</td> <td>10.4 hr</td> <td>15.1 hr</td> <td>20.2 hr</td> </tr> <tr> <td><i>discrete model</i></td> <td>10.5 hr</td> <td>15 hr</td> <td>10.1 hr</td> <td>14.7 hr</td> <td>19.7 hr</td> </tr> </tbody> </table>	Models	6-cell 48Wh	6-cell 72Wh	3 + 3-cell	3 + 6-cell 48Wh	3 + 6-cell 72Wh	<i>Integrated model</i>	10.8 hr	15.3 hr	10.4 hr	15.1 hr	20.2 hr	<i>discrete model</i>	10.5 hr	15 hr	10.1 hr	14.7 hr	19.7 hr
Models	6-cell 48Wh	6-cell 72Wh	3 + 3-cell	3 + 6-cell 48Wh	3 + 6-cell 72Wh																					
<i>Integrated model</i>	10.8 hr	15.3 hr	10.4 hr	15.1 hr	20.2 hr																					
<i>discrete model</i>	10.5 hr	15 hr	10.1 hr	14.7 hr	19.7 hr																					
Ethernet	<i>Non-vPro model</i> : Intel Ethernet Connection I219-V (Jacksonville) <i>vPro model</i> : Intel Ethernet Connection I219-LM (Jacksonville)							AC adapter																		
WLAN ⁴	<i>One of the following, configurable by model (WiGig can coexist with WWAN):</i> • 11ac+BT, Broadcom BCM4356, 2x2, M.2 card • 11ac+BT, Intel Dual Band Wireless-AC 8260, 2x2, M.2 card • WiGig™+11ac+BT, Intel Tri-Band Wireless-AC 18260, 2x2 WLAN, WiGig, M.2 card							Preload																		
Bluetooth™	Bluetooth 4.1 wireless, integrated in Wi-Fi + Bluetooth combo adapter							Windows 7 Professional 64 preinstalled through downgrade rights in Windows 10 Pro 64 • Lenovo Solution Center • Lenovo Companion • Lenovo Setting • ThinkVantage Product Recovery • Rescue and Recovery™ • ThinkVantage System Update • Adobe® Reader® • Microsoft® Office preloaded; purchase a product key to activate • McAfee® LiveSafe™ (30-day trial)																		
WWAN (<i>optional</i>)	<i>One of the following, configurable by model (WWAN can coexist with WiGig):</i> • Wireless WAN upgradable • Wireless WAN, Sierra Wireless EM7455, Qualcomm® 4G LTE-Advanced/DC-HSPA+/HSPA+/HSPA/UMTS/GNSS, M.2 card • Wireless WAN, HUAWEI ME906S, HUAWEI 4G LTE/WCDMA/HSPA/GSM/GPRS/EDGE/GNSS, M.2 card (WE only)							Limited warranty ¹²																		
SIM card (<i>opt</i>)	Micro-SIM card slot, optional Verizon LTE (US) or Lenovo Connect (WE) SIM card							<i>One of the following, configurable by model:</i> • 1-year depot repair service • 3-year/1-yr battery depot repair service • 3-year/1-yr battery limited onsite service ²⁴ • 3-year/1-yr battery limited onsite service, OID (Onsite International Delivery)																		
Dimensions ³ Weight ²	<i>WxDxH</i> : 13.35" x 9.15" x 0.83"; 339mm x 232.5mm x 21mm							Mil-Spec test																		
	<table border="1"> <thead> <tr> <th>Models</th> <th>No + 6-cell</th> <th>3-cell + 3-cell</th> <th>3-cell + 6-cell</th> </tr> </thead> <tbody> <tr> <td><i>Integrated Non-touch</i></td> <td>3.84 lb / 1.74 kg</td> <td>3.82 lb / 1.73 kg</td> <td>4.13 lb / 1.87 kg</td> </tr> <tr> <td><i>Integrated Multi-touch</i></td> <td>3.91 lb / 1.77 kg</td> <td>3.88 lb / 1.76 kg</td> <td>4.20 lb / 1.90 kg</td> </tr> <tr> <td><i>Discrete Non-touch</i></td> <td>3.86 lb / 1.75 kg</td> <td>3.90 lb / 1.77 kg</td> <td>4.22 lb / 1.91 kg</td> </tr> <tr> <td><i>Discrete Multi-touch</i></td> <td>3.93 lb / 1.78 kg</td> <td>3.97 lb / 1.80 kg</td> <td>4.28 lb / 1.94 kg</td> </tr> </tbody> </table>	Models	No + 6-cell	3-cell + 3-cell	3-cell + 6-cell	<i>Integrated Non-touch</i>	3.84 lb / 1.74 kg	3.82 lb / 1.73 kg	4.13 lb / 1.87 kg	<i>Integrated Multi-touch</i>	3.91 lb / 1.77 kg	3.88 lb / 1.76 kg	4.20 lb / 1.90 kg	<i>Discrete Non-touch</i>	3.86 lb / 1.75 kg	3.90 lb / 1.77 kg	4.22 lb / 1.91 kg	<i>Discrete Multi-touch</i>	3.93 lb / 1.78 kg	3.97 lb / 1.80 kg	4.28 lb / 1.94 kg	Environment				
Models	No + 6-cell	3-cell + 3-cell	3-cell + 6-cell																							
<i>Integrated Non-touch</i>	3.84 lb / 1.74 kg	3.82 lb / 1.73 kg	4.13 lb / 1.87 kg																							
<i>Integrated Multi-touch</i>	3.91 lb / 1.77 kg	3.88 lb / 1.76 kg	4.20 lb / 1.90 kg																							
<i>Discrete Non-touch</i>	3.86 lb / 1.75 kg	3.90 lb / 1.77 kg	4.22 lb / 1.91 kg																							
<i>Discrete Multi-touch</i>	3.93 lb / 1.78 kg	3.97 lb / 1.80 kg	4.28 lb / 1.94 kg																							
Case material	Glass-Fiber Reinforced Plastic							EPEAT™ Gold (US only); ENERGY STAR® 6.1; GREENGUARD®; RoHS-compliant																		

Model	Region	Processor	vPro	Graphics	Memory	Display	Multi-touch	Storage	Optical	WLAN + Bluetooth	WWAN	SIM Card	Smart Card Reader	Dock	Camera	Keyboard	Fingerprint Reader	Battery (internal+ external)	Power Adapter	Operating System	Warranty	Ann Date (m/y)
20FN002JUS	US	i5-6300U	vPro	Intel HD 520	8GBx1	14" FHD (1920x1080) IPS	None	256GB SSD Opal2	None	Intel 8260 ac, 2x2 + BT4.1	WWAN Upgradable	None	None	None	720p	Backlit	Fingerprint Reader	3-cell(23Wh) + 3-cell(23Wh)	45W	Win10 DG Win7 Pro 64	3-year, Depot	01/16
20FN002KUS	US	i7-6600U	vPro	Intel HD 520	8GBx2	14" FHD (1920x1080) IPS	None	512GB SSD	None	Intel 8260 ac, 2x2 + BT4.1	WWAN Upgradable	None	None	None	720p	Backlit	Fingerprint Reader	3-cell(23Wh) + 3-cell(23Wh)	45W	Win10 DG Win7 Pro 64	3-year, Depot	01/16
20FN002LUS	US	i7-6600U	vPro	Intel HD 520	8GBx2	14" FHD (1920x1080) IPS	10-point Multi-touch	512GB SSD	None	Intel 8260 ac, 2x2 + BT4.1	WWAN Upgradable	None	None	None	720p	Backlit	Fingerprint Reader	3-cell(23Wh) + 3-cell(23Wh)	45W	Win10 DG Win7 Pro 64	3-year, Depot	01/16
20FN002MUS	US	i5-6300U	vPro	Intel HD 520	8GBx1	14" FHD (1920x1080) IPS	None	180GB SSD Opal2	None	Intel 8260 ac, 2x2 + BT4.1	WWAN Upgradable	None	None	None	720p	Backlit	Fingerprint Reader	3-cell(23Wh) + 3-cell(23Wh)	45W	Win10 DG Win7 Pro 64	3-year, Depot	01/16
20FN002NUS	US	i5-6300U	vPro	Intel HD 520	8GBx1	14" FHD (1920x1080) IPS	None	500GB 7200rpm	None	Intel 8260 ac, 2x2 + BT4.1	WWAN Upgradable	None	None	None	720p	Backlit	Fingerprint Reader	3-cell(23Wh) + 3-cell(23Wh)	45W	Win10 DG Win7 Pro 64	3-year, Depot	01/16
20FN002PUS	US	i5-6300U	vPro	Intel HD 520	8GBx1	14" FHD (1920x1080) IPS	10-point Multi-touch	256GB SSD Opal2	None	Intel 8260 ac, 2x2 + BT4.1	WWAN Upgradable	None	None	None	720p	Backlit	Fingerprint Reader	3-cell(23Wh) + 3-cell(23Wh)	45W	Win10 Pro 64	3-year, Depot	01/16
20FN002QUS	US	i5-6300U	vPro	Intel HD 520	4GBx1	14" FHD (1920x1080) IPS	None	500GB 7200rpm	None	Intel 8260 ac, 2x2 + BT4.1	WWAN Upgradable	None	None	None	720p	Backlit	Fingerprint Reader	3-cell(23Wh) + 3-cell(23Wh)	45W	Win10 DG Win7 Pro 64	3-year, Depot	01/16
20FN002RUS	US	i7-6600U	vPro	Intel HD 520	8GBx2	14" FHD (1920x1080) IPS	10-point Multi-touch	512GB SSD	None	Intel 8260 ac, 2x2 + BT4.1	WWAN Upgradable	None	None	None	720p	Backlit	Fingerprint Reader	3-cell(23Wh) + 3-cell(23Wh)	45W	Win10 Pro 64	3-year, Depot	01/16
20FN002SUS	US	i5-6200U	No	Intel HD 520	4GBx1	14" HD (1366x768)	None	500GB 7200rpm	None	Intel 8260 ac, 2x2 + BT4.1	WWAN Upgradable	None	None	None	720p	Non-backlit	Fingerprint Reader	3-cell(23Wh) + 3-cell(23Wh)	45W	Win10 DG Win7 Pro 64	1-year, Depot	01/16
20FN002TUS	US	i5-6300U	vPro	Intel HD 520	4GBx1	14" HD (1366x768)	None	500GB 7200rpm	None	Intel 8260 ac, 2x2 + BT4.1	WWAN Upgradable	None	None	None	720p	Non-backlit	Fingerprint Reader	3-cell(23Wh) + 3-cell(23Wh)	45W	Win10 DG Win7 Pro 64	1-year, Depot	01/16
20FN002UUS	US	i5-6300U	vPro	Intel HD 520	4GBx1	14" FHD (1920x1080) IPS	None	180GB SSD Opal2	None	Intel 8260 ac, 2x2 + BT4.1	WWAN Upgradable	None	None	None	720p	Backlit	Fingerprint Reader	3-cell(23Wh) + 3-cell(23Wh)	45W	Win10 DG Win7 Pro 64	3-year, Depot	01/16
20FN002VUS	US	i7-6600U	vPro	Intel HD 520	8GBx1	14" FHD (1920x1080) IPS	None	256GB SSD Opal2	None	Intel 8260 ac, 2x2 + BT4.1	WWAN Upgradable	None	None	None	720p	Backlit	Fingerprint Reader	3-cell(23Wh) + 3-cell(23Wh)	45W	Win10 DG Win7 Pro 64	3-year, Depot	01/16
20FN003CUS	US	i5-6200U	No	Intel HD 520	8GBx1	14" HD (1366x768)	None	128GB SSD	None	Intel 8260 ac, 2x2 + BT4.1	WWAN Upgradable	None	None	None	720p	Backlit	Fingerprint Reader	3-cell(23Wh) + 3-cell(23Wh)	45W	Win10 DG Win7 Pro 64	3-year, Depot	01/16
20FN003DUS	US	i5-6200U	No	Intel HD 520	8GBx1	14" HD (1366x768)	None	192GB SSD	None	Intel 8260 ac, 2x2 + BT4.1	WWAN Upgradable	None	None	None	720p	Backlit	Fingerprint Reader	3-cell(23Wh) + 3-cell(23Wh)	45W	Win10 DG Win7 Pro 64	3-year, Depot	01/16
20FN003EUS	US	i5-6300U	vPro	Intel HD 520	8GBx1	14" FHD (1920x1080) IPS	None	240GB SSD Opal2	None	Intel 8260 ac, 2x2 + BT4.1	WWAN Upgradable	None	None	None	720p	Backlit	Fingerprint Reader	3-cell(23Wh) + 3-cell(23Wh)	45W	Win10 DG Win7 Pro 64	3-year, Depot	01/16
20FN003FUS	US	i5-6300U	vPro	Intel HD 520	8GBx1	14" FHD (1920x1080) IPS	None	192GB SSD	None	Intel 8260 ac, 2x2 + BT4.1	WWAN Upgradable	None	None	None	720p	Backlit	Fingerprint Reader	3-cell(23Wh) + 3-cell(23Wh)	45W	Win10 DG Win7 Pro 64	3-year, Depot	01/16
20FN003RUS	US	i5-6200U	No	Intel HD 520	4GBx2	14" HD (1366x768)	None	128GB SSD	None	Intel 8260 ac, 2x2 + BT4.1	WWAN Upgradable	None	None	None	720p	Backlit	Fingerprint Reader	3-cell(23Wh) + 3-cell(23Wh)	45W	Win10 DG Win7 Pro 64	3-year, Depot	01/16
20FN003SUS	US	i5-6200U	No	Intel HD 520	4GBx2	14" FHD (1920x1080) IPS	None	192GB SSD	None	Intel 8260 ac, 2x2 + BT4.1	WWAN Upgradable	None	None	None	720p	Backlit	Fingerprint Reader	3-cell(23Wh) + 3-cell(23Wh)	45W	Win10 DG Win7 Pro 64	3-year, Depot	01/16
20FN003TUS	US	i5-6300U	vPro	Intel HD 520	4GBx2	14" FHD (1920x1080) IPS	None	192GB SSD	None	Intel 8260 ac, 2x2 + BT4.1	WWAN Upgradable	None	None	None	720p	Backlit	Fingerprint Reader	3-cell(23Wh) + 3-cell(23Wh)	45W	Win10 DG Win7 Pro 64	3-year, Depot	01/16
20FN003UUS	US	i5-6300U	vPro	Intel HD 520	4GBx2	14" FHD (1920x1080) IPS	None	240GB SSD Opal2	None	Intel 8260 ac, 2x2 + BT4.1	WWAN Upgradable	None	None	None	720p	Backlit	Fingerprint Reader	3-cell(23Wh) + 3-cell(23Wh)	45W	Win10 DG Win7 Pro 64	3-year, Depot	01/16

Model	Region	Processor	vPro	Graphics	Memory	Display	Multi-touch	Storage	Optical	WLAN + Bluetooth	WWAN	SIM Card	Smart Card Reader	Dock	Camera	Keyboard	Fingerprint Reader	Battery (internal+ external)	Power Adapter	Operating System	Warranty	Ann Date (m/y)
20FN004UUS	US	i5-6300U	vPro	Intel HD 520	8GBx1	14" FHD (1920x1080) IPS	None	180GB SSD Opal2	None	Intel 8260 ac, 2x2 + BT4.1	WWAN Upgradable	None	None	None	720p	Backlit	Fingerprint Reader	3-cell(23Wh) + 3-cell(23Wh)	45W	Win10 Pro 64	3-year, Depot	08/16
20FN004VUS	US	i5-6200U	No	Intel HD 520	4GBx1	14" HD (1366x768)	None	500GB 7200rpm Opal2	None	Intel 8260 ac, 2x2 + BT4.1	WWAN Upgradable	None	None	None	720p	Non-backlit	Fingerprint Reader	3-cell(23Wh) + 3-cell(23Wh)	45W	Win10 Pro 64	1-year, Depot	08/16
20FN0056US	US	i5-6300U	vPro	Intel HD 520	8GBx1	14" FHD (1920x1080) IPS	None	256GB SSD Opal2	None	Intel 8260 ac, 2x2 + BT4.1	WWAN Upgradable	None	None	None	720p	Backlit	Fingerprint Reader	3-cell(23Wh) + 3-cell(23Wh)	45W	Win10 Pro 64	3-year, Depot	10/16
20FN0057US	US	i5-6200U	No	Intel HD 520	4GBx1	14" HD (1366x768)	None	500GB 7200rpm	None	Intel 8260 ac, 2x2 + BT4.1	WWAN Upgradable	None	None	None	720p	Non-backlit	Fingerprint Reader	3-cell(23Wh) + 3-cell(23Wh)	45W	Win10 Pro 64	1-year, Depot	10/16
20FN0059US	US	i5-6200U	No	Intel HD 520	8GBx1	14" FHD (1920x1080) IPS	10-point Multi-touch	256GB SSD Opal2	None	Intel 8260 ac, 2x2 + BT4.1	WWAN Upgradable	None	None	None	720p	Backlit	Fingerprint Reader	3-cell(23Wh) + 3-cell(23Wh)	45W	Win10 Pro 64	3-year, Depot	10/16
20FN005AUS	US	i5-6200U	No	Intel HD 520	8GBx1	14" HD (1366x768)	None	500GB 7200rpm	None	Intel 8260 ac, 2x2 + BT4.1	WWAN Upgradable	None	None	None	720p	Non-backlit	None	3-cell(23Wh) + 3-cell(23Wh)	45W	Win10 Pro 64	1-year, Depot	10/16
20FN005BUS	US	i5-6200U	No	Intel HD 520	8GBx1	14" FHD (1920x1080) IPS	None	256GB SSD Opal2	None	Intel 8260 ac, 2x2 + BT4.1	WWAN Upgradable	None	None	None	720p	Backlit	Fingerprint Reader	3-cell(23Wh) + 3-cell(23Wh)	45W	Win10 DG Win7 Pro 64	3-year, Depot	11/16
20FN005CUS	US	i5-6200U	No	Intel HD 520	4GBx1	14" FHD (1920x1080) IPS	None	180GB SSD Opal2	None	Intel 8260 ac, 2x2 + BT4.1	WWAN Upgradable	None	None	None	720p	Backlit	Fingerprint Reader	3-cell(23Wh) + 3-cell(23Wh)	45W	Win10 DG Win7 Pro 64	3-year, Depot	11/16
20FN005DUS	US	i5-6200U	No	Intel HD 520	4GBx1	14" FHD (1920x1080) IPS	None	256GB SSD Opal2	None	Intel 8260 ac, 2x2 + BT4.1	WWAN Upgradable	None	None	None	720p	Backlit	Fingerprint Reader	3-cell(23Wh) + 3-cell(23Wh)	45W	Win10 DG Win7 Pro 64	3-year, Depot	11/16
20FN005EUS	US	i5-6200U	No	Intel HD 520	8GBx1	14" FHD (1920x1080) IPS	None	180GB SSD Opal2	None	Intel 8260 ac, 2x2 + BT4.1	WWAN Upgradable	None	None	None	720p	Backlit	Fingerprint Reader	3-cell(23Wh) + 3-cell(23Wh)	45W	Win10 DG Win7 Pro 64	3-year, Depot	11/16
20FN005FUS	US	i5-6300U	vPro	Intel HD 520	4GBx1	14" FHD (1920x1080) IPS	None	256GB SSD Opal2	None	Intel 8260 ac, 2x2 + BT4.1	WWAN Upgradable	None	None	None	720p	Backlit	Fingerprint Reader	3-cell(23Wh) + 3-cell(23Wh)	45W	Win10 DG Win7 Pro 64	3-year, Depot	11/16
20FN005GUS	US	i5-6300U	vPro	Intel HD 520	4GBx1	14" FHD (1920x1080) IPS	None	500GB 7200rpm	None	Intel 8260 ac, 2x2 + BT4.1	WWAN Upgradable	None	None	None	720p	Non-backlit	Fingerprint Reader	3-cell(23Wh) + 3-cell(23Wh)	45W	Win10 DG Win7 Pro 64	1-year, Depot	12/16
20FN005HUS	US	i5-6200U	No	Intel HD 520	4GBx2	14" FHD (1920x1080) IPS	None	128GB SSD	None	Intel 8260 ac, 2x2 + BT4.1	WWAN Upgradable	None	None	None	720p	Backlit	Fingerprint Reader	3-cell(23Wh) + 3-cell(23Wh)	45W	Win10 DG Win7 Pro 64	3-year, Depot	12/16
20FN005JUS	US	i5-6200U	No	Intel HD 520	4GBx1	14" FHD (1920x1080) IPS	None	500GB 7200rpm	None	Intel 8260 ac, 2x2 + BT4.1	WWAN Upgradable	None	None	None	720p	Non-backlit	Fingerprint Reader	3-cell(23Wh) + 3-cell(23Wh)	45W	Win10 DG Win7 Pro 64	1-year, Depot	12/16
20FN005KUS	US	i5-6200U	No	Intel HD 520	8GBx1	14" FHD (1920x1080) IPS	None	500GB 7200rpm	None	Intel 8260 ac, 2x2 + BT4.1	WWAN Upgradable	None	None	None	720p	Non-backlit	Fingerprint Reader	3-cell(23Wh) + 3-cell(23Wh)	45W	Win10 Pro 64	1-year, Depot	12/16
20FN005LUS	US	i5-6200U	No	Intel HD 520	4GBx1	14" FHD (1920x1080) IPS	None	500GB 7200rpm	None	Intel 8260 ac, 2x2 + BT4.1	WWAN Upgradable	None	None	None	720p	Non-backlit	Fingerprint Reader	3-cell(23Wh) + 3-cell(23Wh)	45W	Win10 Pro 64	1-year, Depot	12/16
20FN005MUS	US	i5-6200U	No	Intel HD 520	4GBx1	14" FHD (1920x1080) IPS	None	500GB 7200rpm Opal2	None	Intel 8260 ac, 2x2 + BT4.1	WWAN Upgradable	None	None	None	720p	Non-backlit	Fingerprint Reader	3-cell(23Wh) + 3-cell(23Wh)	45W	Win10 Pro 64	1-year, Depot	12/16
20FNA04PUS	US	i7-6600U	vPro	Intel HD 520	8GBx1	14" FHD (1920x1080) IPS	None	256GB SSD Opal2	None	Intel 8260 ac, 2x2 + BT4.1	WWAN Upgradable	None	None	None	720p	Backlit	Fingerprint Reader	3-cell(23Wh) + 3-cell(23Wh)	45W	Win10 Pro 64	3-year, Depot	08/16



ThinkPad T460p Platform Specifications

Product Specifications Reference (PSREF)

Processor	6th Generation Intel® Core™ i5 / i7 Processor							Smart card reader <i>Optional</i> : Smart card reader				
	Processor Number	# of Cores	# of Threads	Base Frequency	Max Turbo Frequency	Cache	Memory Types	Processor Graphics	Media reader	4-in-1 reader (MMC, SD, SDHC, SDXC)		
	i5-6300HQ	4	4	2.3 GHz	3.2 GHz	6MB	DDR4-2133	Intel HD Graphics 530	Ports	Three USB 3.0 (one Always On), MiniDP, HDMI, Ethernet (RJ-45), Dock connector		
	i5-6440HQ			2.6 GHz	3.5 GHz				Camera (<i>optional</i>)	HD720p resolution, low light sensitive, fixed focus		
	i7-6700HQ			2.6 GHz	3.5 GHz	6MB			Audio support	HD Audio, Realtek® ALC3245 codec / stereo speakers, 1W x 2 / dual array microphone, combo audio/microphone jack		
i7-6820HQ	2.7 GHz			3.6 GHz	8MB	Keyboard			6-row, spill-resistant, multimedia Fn keys, LED backlight			
								UltraNav™	TrackPoint® pointing device and buttonless Mylar surface multi-touch touchpad			
Graphics	Intel HD Graphics 530 in processor only, or Intel HD Graphics 530 in processor and NVIDIA GeForce® 940MX, 2GB memory; supports external digital monitor via HDMI or Mini DisplayPort; supports three independent displays; Max resolution: 4096x2304@60Hz (DisplayPort via Mini DisplayPort cable); 4096x2160@24Hz (HDMI)							Security	Power-on password, hard disk password, supervisor password, security keyhole			
								Security chip	Discrete TPM 1.2 TCG Certified and Firmware TPM 2.0 integrated in chipset			
								ThinkEngine	Delivers improved thermal and power efficiency, up to 30 day standby, faster resume time, enhanced security, as well as anti-tampering measures			
								vPro (<i>optional</i>)	Intel vPro Technology			
								Fingerprint reader	<i>Optional</i> : Touch style fingerprint reader on the keyboard bezel			
Chipset	Mobile Intel QM170 Chipset							Battery	Li-Ion 3-cell (23Wh) or 6-cell (48Wh or 72Wh)			
Memory	32GB max ⁷ / 2133MHz DDR4, dual-channel capable, two DDR4 SO-DIMM sockets							Max battery life ¹⁰				
Display	<i>Some</i> : 14.0" (355mm) FHD (1920x1080), anti-glare, LED backlight, IPS, 250 nits, 16:9 aspect ratio, 600:1 contrast ratio, 160° viewing angle							<i>(MobileMark® 2014)</i>	<i>Models</i>	<i>3-cell</i>	<i>6-cell 48Wh</i>	<i>6-cell 72Wh</i>
	<i>Some</i> : 14.0" (355mm) WQHD (2560x1440), anti-glare, LED backlight, IPS, 300 nits, 16:9 aspect ratio, 700:1 or 800:1 contrast ratio, 160° viewing angle								<i>Integrated model</i>	4.34 hr	8.58 hr	13 hr
Multi-touch	None							AC adapter	<i>discrete model</i>	4.1 hr	8.5 hr	13 hr
Storage	<i>Some</i> : SSD / SATA 6.0Gb/s (e.g. xxxG SSD) <i>Some</i> : SSD / PCIe NVMe, PCIe 3.0 x 2, 16Gb/s (e.g. xxxG SSD PCIe NVMe) <i>Some</i> : HDD / SATA 6.0Gb/s, 2.5" wide, 7mm or 9.5mm high, Shock Mounted Hard Drive, Active Protection System™							90W or 135W AC adapter				
Optical	None							Preload	Windows 7 Professional 64 preinstalled through downgrade rights in Windows 10 Pro 64			
Ethernet	Intel Ethernet Connection I219-LM (Jacksonville)							<ul style="list-style-type: none"> • Lenovo Solution Center • Lenovo Companion • Lenovo Setting • Microsoft Office preloaded; purchase a product key to activate • McAfee® LiveSafe™ (30-day trial) 				
WLAN ⁴	<i>One of the following, configurable by model:</i> • 11ac+BT, Broadcom BCM4356, 2x2, M.2 card • 11ac+BT, Intel Dual Band Wireless-AC 8260, 2x2, M.2 card							<ul style="list-style-type: none"> • ThinkVantage Product Recovery • Rescue and Recovery™ • ThinkVantage System Update • Adobe® Reader® • Microsoft® Office preloaded; purchase a product key to activate • McAfee® LiveSafe™ (30-day trial) 				
Bluetooth™	Bluetooth 4.1 wireless, integrated in Wi-Fi + Bluetooth combo adapter							<ul style="list-style-type: none"> • Microsoft® Office preloaded; purchase a product key to activate • McAfee® LiveSafe™ (30-day trial) 				
WWAN (<i>optional</i>)	<i>One of the following, configurable by model:</i> • Wireless WAN upgradable • Wireless WAN, Sierra Wireless EM7455, Qualcomm® 4G LTE-Advanced/DC-HSPA+/HSPA+/HSPA/UMTS/GNSS, M.2 card • Wireless WAN, HUAWEI ME906S, HUAWEI 4G LTE/WCDMA/HSPA/GSM/GPRS/EDGE/GNSS, M.2 card (WE only)							Limited warranty ¹² <i>One of the following, configurable by model:</i> • 1-year depot repair service • 3-year/1-yr battery depot repair service • 3-year/1-yr battery limited onsite service ²⁴ • 3-year/1-yr battery limited onsite service, OID (Onsite International Delivery)				
SIM card (<i>opt</i>)	Micro-SIM card slot, optional Verizon LTE (US) or Lenovo Connect (WE) SIM card							Mil-Spec test MIL-STD-810G military certification				
Dimensions ³	<i>WxDxH:</i> 13.54" x 9.41" x 0.96"; 344mm x 239mm x 24.4mm							Environment EPEAT™ Gold (US only); ENERGY STAR® 6.1; GREENGUARD®; RoHS-compliant				
Weight ²												
	<i>Models</i>		<i>3-cell</i>		<i>6-cell</i>							
	<i>Integrated model</i>		3.99 lb / 1.81 kg		4.70 lb / 2.13 kg							
<i>discrete model</i>		4.04 lb / 1.83 kg		4.75 lb / 2.15 kg								
Case material	<i>Display cover:</i> PolyCarbonate/Acrylonitrile-Butadiene-Styrene (PC/ABS) plastic; <i>Bottom:</i> Magnesium alloy											

Model	Region	Processor	vPro	Graphics	Memory	Display	Multi-touch	Storage	Optical	WLAN + Bluetooth	WWAN	SIM Card	Smart Card Reader	Camera	Keyboard	Fingerprint Reader	Battery	Power Adapter	Operating System	Warranty	Ann Date (m/y)
20FW000SUS	US	i5-6440HQ	vPro	Intel HD 530	8GBx1	14" FHD (1920x1080) IPS	None	192GB SSD	None	Intel 8260 ac, 2x2 + BT4.1	WWAN Upgradable	None	None	720p	Backlit	Fingerprint Reader	3-cell (23Wh)	90W	Win10 DG Win7 Pro 64	3-year, Depot	03/16
20FW000TUS	US	i7-6820HQ	vPro	940MX 2GB	16GBx1	14" FHD (1920x1080) IPS	None	512GB SSD	None	Intel 8260 ac, 2x2 + BT4.1	WWAN Upgradable	None	None	720p	Backlit	Fingerprint Reader	6-cell (48Wh)	135W	Win10 DG Win7 Pro 64	3-year, Depot	03/16
20FW000UUS	US	i5-6440HQ	vPro	Intel HD 530	8GBx1	14" FHD (1920x1080) IPS	None	192GB SSD	None	Intel 8260 ac, 2x2 + BT4.1	WWAN Upgradable	None	None	720p	Backlit	Fingerprint Reader	6-cell (72Wh)	90W	Win10 DG Win7 Pro 64	3-year, Depot	03/16
20FW000VUS	US	i5-6440HQ	vPro	Intel HD 530	8GBx1	14" FHD (1920x1080) IPS	None	256GB SSD Opal2	None	Intel 8260 ac, 2x2 + BT4.1	WWAN Upgradable	None	None	720p	Backlit	Fingerprint Reader	6-cell (48Wh)	90W	Win10 DG Win7 Pro 64	3-year, Depot	03/16
20FW000WUS	US	i7-6820HQ	vPro	940MX 2GB	8GBx1	14" FHD (1920x1080) IPS	None	256GB SSD Opal2	None	Intel 8260 ac, 2x2 + BT4.1	WWAN Upgradable	None	None	720p	Backlit	Fingerprint Reader	6-cell (48Wh)	135W	Win10 DG Win7 Pro 64	3-year, Depot	03/16
20FW002DUS	US	i5-6440HQ	vPro	Intel HD 530	8GBx1	14" FHD (1920x1080) IPS	None	256GB SSD Opal2	None	Intel 8260 ac, 2x2 + BT4.1	WWAN Upgradable	None	Smart Card Reader	720p	Backlit	Fingerprint Reader	6-cell (48Wh)	90W	Win10 Pro 64	3-year, Depot	03/16
20FW003QUS	US	i5-6440HQ	vPro	940MX 2GB	8GBx1	14" FHD (1920x1080) IPS	None	256GB SSD Opal2	None	Intel 8260 ac, 2x2 + BT4.1	WWAN Upgradable	None	None	720p	Backlit	Fingerprint Reader	6-cell (48Wh)	135W	Win10 Pro 64	3-year, Depot	04/16
20FW003RUS	US	i5-6440HQ	vPro	940MX 2GB	8GBx1	14" FHD (1920x1080) IPS	None	256GB SSD Opal2	None	Intel 8260 ac, 2x2 + BT4.1	WWAN Upgradable	None	None	720p	Backlit	Fingerprint Reader	6-cell (48Wh)	135W	Win10 DG Win7 Pro 64	3-year, Depot	04/16
20FW003SUS	US	i5-6440HQ	vPro	940MX 2GB	8GBx1	14" FHD (1920x1080) IPS	None	512GB SSD	None	Intel 8260 ac, 2x2 + BT4.1	WWAN Upgradable	None	None	720p	Backlit	Fingerprint Reader	6-cell (48Wh)	135W	Win10 DG Win7 Pro 64	3-year, Depot	04/16
20FW003TUS	US	i5-6440HQ	vPro	940MX 2GB	8GBx1	14" FHD (1920x1080) IPS	None	512GB SSD	None	Intel 8260 ac, 2x2 + BT4.1	WWAN Upgradable	None	None	720p	Backlit	Fingerprint Reader	6-cell (48Wh)	135W	Win10 Pro 64	3-year, Depot	04/16
20FW0054US	US	i5-6440HQ	vPro	Intel HD 530	8GBx1	14" FHD (1920x1080) IPS	None	180GB SSD Opal2	None	Intel 8260 ac, 2x2 + BT4.1	WWAN Upgradable	None	None	720p	Backlit	Fingerprint Reader	6-cell (48Wh)	90W	Win10 DG Win7 Pro 64	3-year, Depot	11/16
20FW0055US	US	i5-6440HQ	vPro	Intel HD 530	8GBx1	14" FHD (1920x1080) IPS	None	180GB SSD Opal2	None	Intel 8260 ac, 2x2 + BT4.1	WWAN Upgradable	None	None	720p	Backlit	Fingerprint Reader	3-cell (23Wh)	90W	Win10 DG Win7 Pro 64	3-year, Depot	11/16
20FW0056US	US	i5-6440HQ	vPro	Intel HD 530	8GBx1	14" FHD (1920x1080) IPS	None	256GB SSD Opal2	None	Intel 8260 ac, 2x2 + BT4.1	WWAN Upgradable	None	None	720p	Backlit	Fingerprint Reader	3-cell (23Wh)	90W	Win10 DG Win7 Pro 64	3-year, Depot	11/16
20FW0057US	US	i7-6820HQ	vPro	940MX 2GB	8GBx1	14" FHD (1920x1080) IPS	None	256GB SSD Opal2	None	Intel 8260 ac, 2x2 + BT4.1	WWAN Upgradable	None	None	720p	Backlit	Fingerprint Reader	6-cell (48Wh)	135W	Win10 Pro 64	3-year, Depot	12/16



ThinkPad T460s Platform Specifications

Product Specifications Reference (PSREF)

Processor	6th Generation Intel® Core™ i5 / i7 Processor							Smart card reader Media reader Ports WiGig dock (opt)	Optional: Smart card reader 4-in-1 reader (MMC, SD, SDHC, SDXC) Three USB 3.0 (one Always On), MiniDP, HDMI, Ethernet (RJ-45), Dock connector WiGig dock, mutually exclusive with WWAN	
	Processor Number	# of Cores	# of Threads	Base Frequency	Max Turbo Frequency	Cache	Memory Types			Processor Graphics
	i5-6200U	2	4	2.3 GHz	2.8 GHz	3MB	DDR4-2133			Intel HD Graphics 520
	i5-6300U			2.4 GHz	3 GHz	3MB				
i7-6600U	2.6 GHz			3.4 GHz	4MB					
Graphics	Intel HD Graphics 520 in processor only, or Intel HD Graphics 520 in processor and NVIDIA GeForce® 930M, 2GB memory (discrete graphics is only available in US); supports external digital monitor via HDMI or Mini DisplayPort; supports three independent displays; Max resolution: 3840x2160@60Hz (DisplayPort via Mini DisplayPort cable); 4096x2160@24Hz (HDMI)							Keyboard UltraNav™	6-row, spill-resistant, multimedia Fn keys, optional LED backlight TrackPoint® pointing device and buttonless crystal silk surface multi-touch touchpad	
Chipset	Intel SoC (System on Chip) platform							Security	Power-on password, hard disk password, supervisor password, security keyhole	
Memory	20GB or 24GB max ⁷ / 2133MHz DDR4, dual-channel capable, 4GB or 8GB memory soldered to systemboard, one DDR4 SO-DIMM socket							Security chip ThinkEngine	Discrete TPM 1.2 TCG Certified and Firmware TPM 2.0 integrated in chipset Delivers improved thermal and power efficiency, up to 30 day standby, faster resume time, enhanced security, as well as anti-tampering measures	
Display	Some: 14.0" (355mm) FHD (1920x1080), anti-glare, LED backlight, IPS, 250 nits, 16:9 aspect ratio, 700:1 contrast ratio, 160° viewing angle Some: 14.0" (355mm) WQHD (2560x1440), anti-glare, LED backlight, IPS, 300 nits, 16:9 aspect ratio, 700:1 contrast ratio, 160° viewing angle							vPro (optional) Fingerprint reader	Intel vPro Technology Optional: Touch style fingerprint reader on the palm rest	
Multi-touch (opt)	In-cell touch, supports 10-finger gesture, 250 nits							Internal battery Max battery life ¹⁰ AC adapter	Front Li-Polymer 3-cell (23Wh) and rear Li-Ion 3-cell (26Wh), both Integrated MobileMark® 2014: up to 10.5 hr 45W or 65W AC adapter	
Storage	Some: M.2 SSD / SATA 6.0Gb/s (e.g. xxxG SSD) Some: M.2 SSD / PCIe NVMe, PCIe 3.0 x 4, 32Gb/s (e.g. xxxG SSD PCIe NVMe)							Preload	Windows 7 Professional 64 preinstalled through downgrade rights in Windows 10 Pro 64 • Lenovo Solution Center • Lenovo Companion • Lenovo Setting • Microsoft Office preloaded; purchase a product key to activate • McAfee® LiveSafe™ (30-day trial)	
Optical	None							Limited warranty ¹²	One of the following, configurable by model: • 1-year depot repair service • 3-year/1-yr battery depot repair service • 3-year/1-yr battery limited onsite service ²⁴ • 3-year/1-yr battery limited onsite service, OID (Onsite International Delivery)	
Ethernet	Non-vPro model: Intel Ethernet Connection I219-V (Jacksonville) vPro model: Intel Ethernet Connection I219-LM (Jacksonville)							Mil-Spec test	MIL-STD-810G military certification	
WLAN ⁴	One of the following, configurable by model (WiGig is mutually exclusive with WWAN): • 11ac+BT, Broadcom BCM4356, 2x2, M.2 card • 11ac+BT, Intel Dual Band Wireless-AC 8260, 2x2, M.2 card • WiGig™+11ac+BT, Intel Tri-Band Wireless-AC 18260, 2x2 WLAN, WiGig, M.2 card							Environment	EPEAT™ Gold (US only); ENERGY STAR® 6.1; GREENGUARD®; RoHS-compliant	
Bluetooth™	Bluetooth 4.1 wireless, integrated in Wi-Fi + Bluetooth combo adapter									
WWAN (optional)	One of the following, configurable by model (mutually exclusive with WiGig): • Wireless WAN upgradable • Wireless WAN, Sierra Wireless EM7455, Qualcomm® 4G LTE-Advanced/DC-HSPA+/HSPA+/HSPA/UMTS/GNSS, M.2 card • Wireless WAN, HUAWEI ME906S, HUAWEI 4G LTE/WCDMA/HSPA/GSM/GPRS/EDGE/GNSS, M.2 card (WE only)									
SIM card (opt)	Micro-SIM card slot, optional Verizon LTE (US) or Lenovo Connect (WE) SIM card									
Dimensions ³	WxDxH: 13.03" x 8.93" x 0.67-0.74"; 331mm x 226.8mm x 16.9-18.8mm									
Weight ²	Integrated model: from 3.0 lb (1.36kg); Discrete model: from 3.3 lb (1.50kg)									
Case material	Display cover: Carbon-Fiber Reinforced Plastic; Bottom: Magnesium alloy									

Model	Region	Processor	vPro	Graphics	Memory (Soldered +DIMM)	Display	Multi-touch	Storage(HDD/SSD)	Optical	WLAN + Bluetooth	WWAN	SIM Card	Smart Card Reader	Dock	Camera	Keyboard	Fingerprint Reader	Battery (internal)	Power Adapter	Operating System	Warranty	Ann Date (m/y)
20F90017US	US	i5-6200U	No	Intel HD 520	4GB + 4GB	14" FHD (1920x1080) IPS	None	256GB SSD M.2 Opal2	None	Intel 8260 ac, 2x2 + BT4.1	WWAN Upgradable	None	None	None	720p	Backlit	Fingerprint Reader	3-cell(23Wh) + 3-cell(26Wh)	45W	Win10 Pro 64	3-year, Depot	10/16
20F90018US	US	i5-6200U	No	Intel HD 520	4GB + 4GB	14" FHD (1920x1080) IPS	None	256GB SSD M.2 Opal2	None	Intel 8260 ac, 2x2 + BT4.1	WWAN Upgradable	None	None	None	720p	Backlit	Fingerprint Reader	3-cell(23Wh) + 3-cell(26Wh)	45W	Win10 DG Win7 Pro 64	3-year, Depot	10/16
20F90019US	US	i7-6600U	vPro	Intel HD 520	4GB + 8GB	14" WQHD (2560x1440) IPS	None	512GB SSD M.2	None	Intel 8260 ac, 2x2 + BT4.1	WWAN Upgradable	None	None	None	720p	Backlit	Fingerprint Reader	3-cell(23Wh) + 3-cell(26Wh)	45W	Win10 Pro 64	3-year, Depot	02/16
20F9001CUS	US	i7-6600U	vPro	Intel HD 520	4GB + 4GB	14" FHD (1920x1080) IPS	None	256GB SSD M.2 Opal2	None	Intel 8260 ac, 2x2 + BT4.1	WWAN Upgradable	None	None	None	720p	Backlit	Fingerprint Reader	3-cell(23Wh) + 3-cell(26Wh)	45W	Win10 Pro 64	3-year, Depot	02/16
20F9001DUS	US	i7-6600U	vPro	Intel HD 520	4GB + 8GB	14" FHD (1920x1080) IPS	None	512GB SSD M.2	None	Intel 8260 ac, 2x2 + BT4.1	WWAN Upgradable	None	None	None	720p	Backlit	Fingerprint Reader	3-cell(23Wh) + 3-cell(26Wh)	45W	Win10 DG Win7 Pro 64	3-year, Depot	02/16
20F90033US	US	i7-6600U	vPro	Intel HD 520	4GB + 4GB	14" WQHD (2560x1440) IPS	None	512GB SSD M.2	None	Intel 8260 ac, 2x2 + BT4.1	WWAN Upgradable	None	None	None	720p	Backlit	Fingerprint Reader	3-cell(23Wh) + 3-cell(26Wh)	45W	Win10 DG Win7 Pro 64	3-year, Depot	02/16
20F90034US	US	i5-6300U	vPro	Intel HD 520	4GB Soldered	14" FHD (1920x1080) IPS	None	128GB SSD M.2	None	Intel 8260 ac, 2x2 + BT4.1	WWAN Upgradable	None	None	None	720p	Non-backlit	Fingerprint Reader	3-cell(23Wh) + 3-cell(26Wh)	45W	Win10 DG Win7 Pro 64	3-year, Depot	02/16
20F90035US	US	i7-6600U	vPro	Intel HD 520	4GB + 4GB	14" FHD (1920x1080) IPS	None	512GB SSD M.2	None	Intel 8260 ac, 2x2 + BT4.1	WWAN Upgradable	None	None	None	720p	Backlit	Fingerprint Reader	3-cell(23Wh) + 3-cell(26Wh)	45W	Win10 DG Win7 Pro 64	3-year, Depot	02/16
20F90036US	US	i5-6300U	vPro	Intel HD 520	4GB + 4GB	14" FHD (1920x1080) IPS	None	128GB SSD M.2	None	Intel 8260 ac, 2x2 + BT4.1	WWAN Upgradable	None	None	None	720p	Backlit	Fingerprint Reader	3-cell(23Wh) + 3-cell(26Wh)	45W	Win10 DG Win7 Pro 64	3-year, Depot	02/16
20F90037US	US	i7-6600U	vPro	Intel HD 520	4GB + 4GB	14" FHD (1920x1080) IPS	None	180GB SSD M.2 Opal2	None	Intel 8260 ac, 2x2 + BT4.1	WWAN Upgradable	None	None	None	720p	Backlit	Fingerprint Reader	3-cell(23Wh) + 3-cell(26Wh)	45W	Win10 DG Win7 Pro 64	3-year, Depot	02/16
20F90038US	US	i5-6300U	vPro	Intel HD 520	4GB + 4GB	14" FHD (1920x1080) IPS	10-point Multi-touch	256GB SSD M.2 Opal2	None	Intel 8260 ac, 2x2 + BT4.1	WWAN Upgradable	None	None	None	720p	Backlit	Fingerprint Reader	3-cell(23Wh) + 3-cell(26Wh)	45W	Win10 Pro 64	3-year, Depot	02/16
20F90039US	US	i5-6200U	No	Intel HD 520	4GB Soldered	14" FHD (1920x1080) IPS	None	128GB SSD M.2	None	Intel 8260 ac, 2x2 + BT4.1	WWAN Upgradable	None	None	None	720p	Non-backlit	Fingerprint Reader	3-cell(23Wh) + 3-cell(26Wh)	45W	Win10 DG Win7 Pro 64	1-year, Depot	02/16
20F9003AUS	US	i7-6600U	vPro	Intel HD 520	4GB + 4GB	14" WQHD (2560x1440) IPS	None	256GB SSD M.2 Opal2	None	Intel 8260 ac, 2x2 + BT4.1	WWAN Upgradable	None	None	None	720p	Backlit	Fingerprint Reader	3-cell(23Wh) + 3-cell(26Wh)	45W	Win10 DG Win7 Pro 64	3-year, Depot	02/16
20F9003BUS	US	i5-6300U	vPro	Intel HD 520	4GB Soldered	14" FHD (1920x1080) IPS	None	180GB SSD M.2 Opal2	None	Intel 8260 ac, 2x2 + BT4.1	WWAN Upgradable	None	None	None	720p	Backlit	Fingerprint Reader	3-cell(23Wh) + 3-cell(26Wh)	45W	Win10 DG Win7 Pro 64	3-year, Depot	02/16
20F9003CUS	US	i7-6600U	vPro	Intel HD 520	4GB + 4GB	14" FHD (1920x1080) IPS	None	256GB SSD M.2 Opal2	None	Intel 8260 ac, 2x2 + BT4.1	WWAN Upgradable	None	None	None	720p	Backlit	Fingerprint Reader	3-cell(23Wh) + 3-cell(26Wh)	45W	Win10 DG Win7 Pro 64	3-year, Depot	02/16
20F9003DUS	US	i5-6300U	vPro	Intel HD 520	4GB + 4GB	14" FHD (1920x1080) IPS	None	192GB SSD M.2	None	Intel 8260 ac, 2x2 + BT4.1	WWAN Upgradable	None	None	None	720p	Backlit	Fingerprint Reader	3-cell(23Wh) + 3-cell(26Wh)	45W	Win10 DG Win7 Pro 64	3-year, Depot	02/16
20F9003EUS	US	i5-6300U	vPro	Intel HD 520	4GB + 4GB	14" FHD (1920x1080) IPS	None	128GB SSD M.2	None	Intel 8260 ac, 2x2 + BT4.1	WWAN Upgradable	None	None	None	720p	Non-backlit	Fingerprint Reader	3-cell(23Wh) + 3-cell(26Wh)	45W	Win10 DG Win7 Pro 64	3-year, Depot	02/16
20F9003FUS	US	i7-6600U	vPro	Intel HD 520	4GB + 4GB	14" FHD (1920x1080) IPS	10-point Multi-touch	256GB SSD M.2 Opal2	None	Intel 8260 ac, 2x2 + BT4.1	WWAN Upgradable	None	None	None	720p	Backlit	Fingerprint Reader	3-cell(23Wh) + 3-cell(26Wh)	45W	Win10 Pro 64	3-year, Depot	02/16
20F9003GUS	US	i5-6300U	vPro	Intel HD 520	4GB + 4GB	14" FHD (1920x1080) IPS	None	256GB SSD M.2 Opal2	None	Intel 8260 ac, 2x2 + BT4.1	WWAN Upgradable	None	None	None	720p	Backlit	Fingerprint Reader	3-cell(23Wh) + 3-cell(26Wh)	45W	Win10 DG Win7 Pro 64	3-year, Depot	02/16
20F9003HUS	US	i5-6300U	vPro	Intel HD 520	4GB + 4GB	14" FHD (1920x1080) IPS	None	180GB SSD M.2 Opal2	None	Intel 8260 ac, 2x2 + BT4.1	WWAN Upgradable	None	None	None	720p	Backlit	Fingerprint Reader	3-cell(23Wh) + 3-cell(26Wh)	45W	Win10 DG Win7 Pro 64	3-year, Depot	02/16

Model	Region	Processor	vPro	Graphics	Memory (Soldered +DIMM)	Display	Multi-touch	Storage(HDD/SSD)	Optical	WLAN + Bluetooth	WWAN	SIM Card	Smart Card Reader	Dock	Camera	Keyboard	Fingerprint Reader	Battery (Internal)	Power Adapter	Operating System	Warranty	Ann Date (m/y)
20F9003JUS	US	i5-6300U	vPro	Intel HD 520	4GB Soldered	14" FHD (1920x1080) IPS	None	128GB SSD M.2	None	Intel 8260 ac, 2x2 + BT4.1	WWAN Upgradable	None	None	None	720p	Backlit	Fingerprint Reader	3-cell(23Wh) + 3-cell(26Wh)	45W	Win10 DG Win7 Pro 64	3-year, Depot	02/16
20F9004DUS	US	i7-6600U	vPro	Intel HD 520	4GB + 8GB	14" FHD (1920x1080) IPS	None	512GB SSD M.2	None	Intel 8260 ac, 2x2 + BT4.1	WWAN Upgradable	None	None	None	720p	Backlit	Fingerprint Reader	3-cell(23Wh) + 3-cell(26Wh)	45W	Win10 Pro 64	3-year, Depot	02/16
20F9004EUS	US	i5-6300U	vPro	Intel HD 520	4GB + 4GB	14" FHD (1920x1080) IPS	None	192GB SSD M.2	None	Intel 8260 ac, 2x2 + BT4.1	WWAN Upgradable	None	None	None	720p	Backlit	Fingerprint Reader	3-cell(23Wh) + 3-cell(26Wh)	45W	Win10 Pro 64	3-year, Depot	02/16
20F9004FUS	US	i5-6200U	No	Intel HD 520	4GB + 4GB	14" FHD (1920x1080) IPS	None	192GB SSD M.2	None	Intel 8260 ac, 2x2 + BT4.1	WWAN Upgradable	None	None	None	720p	Backlit	Fingerprint Reader	3-cell(23Wh) + 3-cell(26Wh)	45W	Win10 DG Win7 Pro 64	3-year, Depot	02/16
20F9004GUS	US	i7-6600U	vPro	Intel HD 520	4GB + 8GB	14" WQHD (2560x1440) IPS	None	512GB SSD M.2	None	Intel 18260 ac, 2x2 + BT4.1	None	None	None	WiGig Dock	720p	Backlit	Fingerprint Reader	3-cell(23Wh) + 3-cell(26Wh)	45W	Win10 Pro 64	3-year, Depot	02/16
20F9004JUS	US	i5-6200U	No	Intel HD 520	4GB Soldered	14" FHD (1920x1080) IPS	None	128GB SSD M.2	None	Intel 8260 ac, 2x2 + BT4.1	WWAN Upgradable	None	None	None	720p	Non-backlit	Fingerprint Reader	3-cell(23Wh) + 3-cell(26Wh)	45W	Win10 Pro 64	1-year, Depot	02/16
20F9004LUS	US	i5-6200U	No	Intel HD 520	4GB + 4GB	14" FHD (1920x1080) IPS	None	192GB SSD M.2	None	Intel 8260 ac, 2x2 + BT4.1	WWAN Upgradable	None	None	None	720p	Backlit	Fingerprint Reader	3-cell(23Wh) + 3-cell(26Wh)	45W	Win10 Pro 64	3-year, Depot	02/16
20F9004MUS	US	i7-6600U	vPro	Intel HD 520	4GB + 8GB	14" WQHD (2560x1440) IPS	None	512GB SSD M.2	None	Intel 8260 ac, 2x2 + BT4.1	WWAN Upgradable	None	None	None	720p	Backlit	Fingerprint Reader	3-cell(23Wh) + 3-cell(26Wh)	45W	Win10 DG Win7 Pro 64	3-year, Depot	02/16
20F9004NUS	US	i5-6300U	vPro	Intel HD 520	4GB + 4GB	14" FHD (1920x1080) IPS	None	256GB SSD M.2 Opal2	None	Intel 8260 ac, 2x2 + BT4.1	WWAN Upgradable	None	None	None	720p	Backlit	Fingerprint Reader	3-cell(23Wh) + 3-cell(26Wh)	45W	Win10 Pro 64	3-year, Depot	02/16
20F9004PUS	US	i7-6600U	vPro	Intel HD 520	4GB + 8GB	14" WQHD (2560x1440) IPS	None	512GB SSD M.2	None	Intel 18260 ac, 2x2 + BT4.1	None	None	None	WiGig Dock	720p	Backlit	Fingerprint Reader	3-cell(23Wh) + 3-cell(26Wh)	45W	Win10 DG Win7 Pro 64	3-year, Depot	02/16
20F9005AUS	US	i7-6600U	vPro	Intel HD 520	4GB + 16GB	14" WQHD (2560x1440) IPS	None	512GB SSD M.2	None	Intel 8260 ac, 2x2 + BT4.1	WWAN Upgradable	None	None	None	720p	Backlit	Fingerprint Reader	3-cell(23Wh) + 3-cell(26Wh)	45W	Win10 Pro 64	3-year, Depot	03/16
20F9005BUS	US	i7-6600U	vPro	Intel HD 520	4GB + 16GB	14" WQHD (2560x1440) IPS	None	512GB SSD M.2	None	Intel 8260 ac, 2x2 + BT4.1	WWAN Upgradable	None	None	None	720p	Backlit	Fingerprint Reader	3-cell(23Wh) + 3-cell(26Wh)	45W	Win10 DG Win7 Pro 64	3-year, Depot	03/16
20F9005DUS	US	i7-6600U	vPro	Intel HD 520	4GB + 8GB	14" WQHD (2560x1440) IPS	None	256GB SSD M.2 Opal2	None	Intel 18260 ac, 2x2 + BT4.1	None	None	None	WiGig Dock	720p	Backlit	Fingerprint Reader	3-cell(23Wh) + 3-cell(26Wh)	45W	Win10 Pro 64	3-year, Depot	04/16
20F9005EUS	US	i5-6300U	vPro	930M 2GB	4GB + 4GB	14" FHD (1920x1080) IPS	None	256GB SSD M.2 Opal2	None	Intel 8260 ac, 2x2 + BT4.1	WWAN Upgradable	None	None	None	720p	Backlit	Fingerprint Reader	3-cell(23Wh) + 3-cell(26Wh)	65W	Win10 DG Win7 Pro 64	3-year, Depot	04/16
20F9005FUS	US	i7-6600U	vPro	930M 2GB	8GB Soldered	14" WQHD (2560x1440) IPS	None	512GB SSD M.2	None	Intel 8260 ac, 2x2 + BT4.1	WWAN Upgradable	None	None	None	720p	Backlit	Fingerprint Reader	3-cell(23Wh) + 3-cell(26Wh)	65W	Win10 DG Win7 Pro 64	3-year, Depot	04/16
20F9005GUS	US	i5-6300U	vPro	930M 2GB	4GB + 4GB	14" FHD (1920x1080) IPS	None	256GB SSD M.2 Opal2	None	Intel 8260 ac, 2x2 + BT4.1	WWAN Upgradable	None	None	None	720p	Backlit	Fingerprint Reader	3-cell(23Wh) + 3-cell(26Wh)	65W	Win10 Pro 64	3-year, Depot	04/16
20F9005HUS	US	i7-6600U	vPro	930M 2GB	8GB Soldered	14" FHD (1920x1080) IPS	None	256GB SSD M.2 Opal2	None	Intel 8260 ac, 2x2 + BT4.1	WWAN Upgradable	None	None	None	720p	Backlit	Fingerprint Reader	3-cell(23Wh) + 3-cell(26Wh)	65W	Win10 Pro 64	3-year, Depot	04/16
20F9005JUS	US	i7-6600U	vPro	930M 2GB	8GB Soldered	14" WQHD (2560x1440) IPS	None	512GB SSD M.2	None	Intel 8260 ac, 2x2 + BT4.1	WWAN Upgradable	None	None	None	720p	Backlit	Fingerprint Reader	3-cell(23Wh) + 3-cell(26Wh)	65W	Win10 Pro 64	3-year, Depot	04/16
20F9005KUS	US	i7-6600U	vPro	930M 2GB	8GB Soldered	14" FHD (1920x1080) IPS	None	256GB SSD M.2 Opal2	None	Intel 8260 ac, 2x2 + BT4.1	WWAN Upgradable	None	None	None	720p	Backlit	Fingerprint Reader	3-cell(23Wh) + 3-cell(26Wh)	65W	Win10 DG Win7 Pro 64	3-year, Depot	04/16
20F9005LUS	US	i7-6600U	vPro	Intel HD 520	4GB + 8GB	14" WQHD (2560x1440) IPS	None	256GB SSD M.2 Opal2	None	Intel 18260 ac, 2x2 + BT4.1	None	None	None	WiGig Dock	720p	Backlit	Fingerprint Reader	3-cell(23Wh) + 3-cell(26Wh)	45W	Win10 DG Win7 Pro 64	3-year, Depot	04/16

Model	Region	Processor	vPro	Graphics	Memory (Soldered +DIMM)	Display	Multi-touch	Storage(HDD/SSD)	Optical	WLAN + Bluetooth	WWAN	SIM Card	Smart Card Reader	Dock	Camera	Keyboard	Fingerprint Reader	Battery (internal)	Power Adapter	Operating System	Warranty	Ann Date (m/y)
20F9006XUS	US	i5-6200U	No	Intel HD 520	4GB + 4GB	14" FHD (1920x1080) IPS	None	180GB SSD M.2 Opal2	None	Intel 8260 ac, 2x2 + BT4.1	WWAN Upgradable	None	None	None	720p	Backlit	Fingerprint Reader	3-cell(23Wh) + 3-cell(26Wh)	45W	Win10 DG Win7 Pro 64	3-year, Depot	10/16
20F9006YUS	US	i5-6200U	No	Intel HD 520	4GB + 4GB	14" FHD (1920x1080) IPS	None	180GB SSD M.2 Opal2	None	Intel 8260 ac, 2x2 + BT4.1	WWAN Upgradable	None	None	None	720p	Backlit	Fingerprint Reader	3-cell(23Wh) + 3-cell(26Wh)	45W	Win10 Pro 64	3-year, Depot	10/16
20F90076US	US	i5-6200U	No	Intel HD 520	4GB + 4GB	14" WQHD (2560x1440) IPS	None	180GB SSD M.2 Opal2	None	Intel 8260 ac, 2x2 + BT4.1	WWAN Upgradable	None	None	None	720p	Backlit	Fingerprint Reader	3-cell(23Wh) + 3-cell(26Wh)	45W	Win10 DG Win7 Pro 64	3-year, Depot	10/16
20F90077US	US	i5-6300U	vPro	Intel HD 520	4GB + 4GB	14" FHD (1920x1080) IPS	None	180GB SSD M.2 Opal2	None	Intel 8260 ac, 2x2 + BT4.1	WWAN Upgradable	None	None	None	720p	Backlit	Fingerprint Reader	3-cell(23Wh) + 3-cell(26Wh)	45W	Win10 Pro 64	3-year, Depot	11/16



ThinkPad T470 Platform Specifications

Product Specifications Reference (PSREF)

Processor	6th Generation Intel® Core™ i5 / i7 Processor								Dimensions WxDxH: 13.25" x 9.15" x 0.79"; 336.6mm x 232.5mm x 19.95mm																							
	Processor Number	# of Cores	# of Threads	Base Frequency	Max Turbo Frequency	Cache	Memory Types	Processor Graphics		Weight																						
	i5-6200U	2	4	2.3 GHz	2.8 GHz	3MB	DDR4-2133	Intel HD Graphics 520	<i>Models</i>	3-cell or 3 + 3-cell	6-cell or 3 + 6-cell																					
	i5-6300U			2.4 GHz	3.0 GHz	3MB			Magnesium	3.49 lb / 1.58 kg	3.92 lb / 1.78 kg																					
	i7-6500U			2.5 GHz	3.1 GHz	4MB			PPS	3.63 lb / 1.65 kg	4.35 lb / 1.85 kg																					
	i7-6600U			2.6 GHz	3.4 GHz	4MB																										
	or 7th Generation Intel Core i3 / i5 / i7 Processor								Case color	Black																						
	Processor Number	# of Cores	# of Threads	Base Frequency	Max Turbo Frequency	Cache	Memory Types	Processor Graphics	Case material	<i>Display cover:</i> Magnesium Hybrid or PPS; <i>Bottom:</i> Glass-Fiber Reinforced Plastic																						
	i3-7100U	2	4	2.4 GHz	-	3MB	DDR4-2133	Intel HD Graphics 620	Smart card reader	<i>Optional:</i> Smart card reader																						
	i5-7200U			2.5 GHz	3.1 GHz	3MB			Media reader	SD 3.0, UHS-I																						
	i5-7300U			2.6 GHz	3.5 GHz	3MB			Ports	Three USB 3.1 Gen 1 / USB 3.0 (one Always On), USB 3.1 Type-C Gen 2 / Thunderbolt 3 / DisplayPort 1.2a / Power Delivery 2.0, HDMI 1.4b, Ethernet (RJ-45), Dock connector																						
	i7-7500U			2.7 GHz	3.5 GHz	4MB			WiGig dock (<i>opt</i>)	ThinkPad WiGig dock																						
	i7-7600U			2.8 GHz	3.9 GHz	4MB			Monitor cable	<i>Optional:</i> Lenovo USB-C to VGA Adapter																						
	Intel HD Graphics 520 or 620 in processor only, or Intel HD Graphics 520 or 620 in processor and NVIDIA GeForce® 940MX, 2GB 2.5GHz GDDR5 memory; supports external digital monitor via HDMI or USB Type-C; supports three independent displays; Max resolution: 4096x2304@60Hz (USB Type-C); 4096x2160@24Hz (HDMI)								Camera (<i>optional</i>)	720p: HD720p resolution, fixed focus IR & 720p: IR camera and HD720p camera (mutually exclusive with WiGig)																						
Graphics									Audio support	HD Audio, Realtek ALC3268 codec / stereo speakers, 2W x 2 / dual array microphone, combo audio/microphone jack																						
Chipset	Intel SoC (System on Chip) platform								Keyboard	6-row, spill-resistant, multimedia Fn keys, optional LED backlight																						
Memory	32GB max / 2400MHz DDR4, dual-channel capable, two DDR4 SO-DIMM sockets * System clocks down for processors with lower memory controller								UltraNav™	TrackPoint® pointing device and buttonless Mylar surface multi-touch touchpad																						
Display	<i>Some:</i> 14.0" (355mm) HD (1366x768), anti-glare, LED backlight, 220 nits, 16:9 aspect ratio, 400:1 contrast ratio <i>Some:</i> 14.0" (355mm) FHD (1920x1080), anti-glare, LED backlight, IPS, 250 nits, 16:9 aspect ratio, 700:1 contrast ratio, 170° viewing angle touch, supports 10-finger gesture (FHD only)								Security	Power-on password, hard disk password, supervisor password, security keyhole																						
Multi-touch (<i>opt</i>)	On-cell touch, supports 10-finger gesture (FHD only)								Security chip	Win7 model: discrete TPM 1.2, TCG Certified Win10 model: discrete TPM 2.0, TCG Certified																						
Storage	<i>System has one HDD slot or one M.2 2280 slot exclusively for storage</i> <i>Some:</i> HDD / SATA 6.0Gb/s, 2.5" wide, 7mm high, Active Protection System™ <i>Some:</i> SSD / SATA 6.0Gb/s, 2.5" wide, 7mm high (e.g. xxxGB SSD) <i>Some:</i> M.2 SSD / PCIe NVMe, PCIe 3.0 x 2, 16Gb/s <i>Some:</i> 128GB M.2 SSD / SATA 6.0Gb/s, in WWAN slot as 2nd Storage, mutually exclusive with WiGig <i>Some:</i> 16GB Intel Optane™ memory, PCIe NVMe, PCIe 3.0 x 2, 16Gb/s, in WWAN slot as storage cache for HDD, mutually exclusive with WiGig								vPro (<i>optional</i>)	Intel vPro Technology																						
Optical	None								Fingerprint reader	<i>Optional:</i> Touch style match on chip fingerprint reader on the keyboard bezel																						
Ethernet	<i>Non-vPro model:</i> Intel Ethernet Connection I219-V (Jacksonville) <i>vPro model:</i> Intel Ethernet Connection I219-LM (Jacksonville)								NFC (<i>optional</i>)	Near Field Communication																						
WLAN	<i>One of the following, configurable by model (WiGig can coexist with WWAN):</i> • Realtek® RTL8822BE, Wi-Fi 2x2 802.11ac + BT4.1, M.2 card • Intel Dual Band Wireless-AC 8260, Wi-Fi 2x2 802.11ac + BT4.1, M.2 card • Intel Dual Band Wireless-AC 8265, Wi-Fi 2x2 802.11ac + BT4.1, M.2 card • Intel Tri-Band Wireless-AC 18265, WiGig 802.11ad + Wi-Fi 2x2 802.11ac + BT4.1, M.2 card								Internal battery	<i>Optional:</i> Integrated Li-Polymer 3-cell (24Wh)																						
Bluetooth™	Bluetooth 4.1 wireless, integrated in Wi-Fi + Bluetooth combo adapter * Intel 8265ac / 18265ac card support BT4.2 but is limited to BT4.1 by Windows OS								External battery	Li-Polymer 3-cell (24Wh) or Li-Ion 6-cell (48Wh or 72Wh)																						
WWAN (<i>optional</i>)	<i>One of the following, configurable by model (WWAN can coexist with WiGig):</i> • Wireless WAN upgradable • Integrated Mobile Broadband 4G LTE-A, Qualcomm® Snapdragon™ X7 LTE-A (Sierra Wireless EM7455), M.2 card • Integrated Mobile Broadband 4G LTE, Intel XMM™ 7160 (Fibocom L831-EAU), M.2 card (EMEA only)								Max battery life (<i>MobileMark® 2014</i>)	<table border="1"> <thead> <tr> <th><i>Models</i></th> <th>3-cell</th> <th>3 + 3-cell</th> <th>6-cell 48Wh</th> <th>6-cell 72Wh</th> <th>3 + 6-cell 48Wh</th> <th>3 + 6-cell 72Wh</th> </tr> </thead> <tbody> <tr> <td><i>Integrated</i></td> <td>6.9 hr</td> <td>13.9 hr</td> <td>13.9 hr</td> <td>20.9 hr</td> <td>20.9 hr</td> <td>27.1 hr</td> </tr> <tr> <td><i>Discrete</i></td> <td>6.9 hr</td> <td>13.9 hr</td> <td>14.3 hr</td> <td>21.6 hr</td> <td>21.2 hr</td> <td>28.6 hr</td> </tr> </tbody> </table>		<i>Models</i>	3-cell	3 + 3-cell	6-cell 48Wh	6-cell 72Wh	3 + 6-cell 48Wh	3 + 6-cell 72Wh	<i>Integrated</i>	6.9 hr	13.9 hr	13.9 hr	20.9 hr	20.9 hr	27.1 hr	<i>Discrete</i>	6.9 hr	13.9 hr	14.3 hr	21.6 hr	21.2 hr	28.6 hr
<i>Models</i>	3-cell	3 + 3-cell	6-cell 48Wh	6-cell 72Wh	3 + 6-cell 48Wh	3 + 6-cell 72Wh																										
<i>Integrated</i>	6.9 hr	13.9 hr	13.9 hr	20.9 hr	20.9 hr	27.1 hr																										
<i>Discrete</i>	6.9 hr	13.9 hr	14.3 hr	21.6 hr	21.2 hr	28.6 hr																										
SIM card (<i>opt</i>)	Micro-SIM card slot, opt Verizon LTE (US) or Lenovo® Connect (EMEA) SIM card								AC adapter	45W or 65W AC adapter (slim tip), 45W or 65W USB Type-C AC adapter																						
									Preload	Windows® 7 Professional 64 preinstalled through downgrade rights in Windows 10 Pro 64 • Lenovo Solution Center • Lenovo PowerEngage • ThinkVantage Product Recovery • ThinkVantage System Update • Adobe® Reader® • Microsoft® Office preloaded; purchase a product key to activate • McAfee® LiveSafe™ (30-day trial) <i>Some:</i> Windows 10 Home 64 <i>Some:</i> Windows 10 Pro 64 • Lenovo Companion • Lenovo Setting • Microsoft Office preloaded; purchase a product key to activate																						
									Limited warranty	<i>One of the following, configurable by model:</i> • 1-year depot repair service • 3-year/1-yr battery depot repair service • 3-year/1-yr battery limited onsite service																						
									Mil-Spec test	MIL-STD-810G military certification																						
									Environment	EPEAT™ Gold (US only); ENERGY STAR® 6.1; RoHS-compliant																						

ThinkPad T470 - TopSeller - 20HD

Product Specifications Reference (PSREF)

Model	Region	Processor	vPro	Graphics	Memory	Display	Multi-touch	Storage(HDD/SSD)	Optical	WLAN + Bluetooth	WWAN	SIM Card	Smart Card Reader	Dock	Monitor Cable	Case Material	Camera	Key-board	Finger-print Reader	NFC	TPM	Battery (internal+external)	Power Adapter	OS	Warranty	Ann Date (m/y)
20HD000QUS	US	i5-7200U	No	Intel HD 620	8GBx1	14" FHD (1920x1080) IPS	None	500GB 7200rpm	None	Intel 8265 ac, 2x2 + BT4.1	WWAN Upgradable	None	None	None	None	PPS	720p	Non-backlit	Finger-print Reader	None	dTPM 2.0	3-cell(24Wh) + 3-cell(24Wh)	45W	Win10 Pro 64	1-year, Depot	01/17
20HD000RUS	US	i5-7300U	vPro	Intel HD 620	8GBx1	14" FHD (1920x1080) IPS	None	256GB SSD PCIe NVMe Opal2	None	Intel 8265 ac, 2x2 + BT4.1	WWAN Upgradable	None	None	None	None	PPS	720p	Backlit	Finger-print Reader	None	dTPM 2.0	3-cell(24Wh) + 3-cell(24Wh)	45W	Win10 Pro 64	3-year, Depot	01/17
20HD000SUS	US	i5-7200U	No	Intel HD 620	8GBx1	14" FHD (1920x1080) IPS	None	128GB SSD	None	Intel 8265 ac, 2x2 + BT4.1	WWAN Upgradable	None	None	None	None	PPS	720p	Backlit	Finger-print Reader	None	dTPM 2.0	3-cell(24Wh) + 3-cell(24Wh)	45W	Win10 Pro 64	3-year, Depot	01/17
20HD000TUS	US	i5-7200U	No	Intel HD 620	8GBx1	14" HD (1366x768)	None	500GB 7200rpm	None	Intel 8265 ac, 2x2 + BT4.1	WWAN Upgradable	None	None	None	None	PPS	720p	Non-backlit	Finger-print Reader	None	dTPM 2.0	3-cell(24Wh) + 3-cell(24Wh)	45W	Win10 Pro 64	1-year, Depot	01/17
20HD000UUS	US	i5-7200U	No	Intel HD 620	8GBx1	14" HD (1366x768)	None	128GB SSD	None	Intel 8265 ac, 2x2 + BT4.1	WWAN Upgradable	None	None	None	None	PPS	720p	Backlit	Finger-print Reader	None	dTPM 2.0	3-cell(24Wh) + 3-cell(24Wh)	45W	Win10 Pro 64	3-year, Depot	01/17
20HD000VUS	US	i5-7300U	vPro	Intel HD 620	8GBx1	14" FHD (1920x1080) IPS	None	512GB SSD PCIe NVMe Opal2	None	Intel 8265 ac, 2x2 + BT4.1	WWAN Upgradable	None	None	None	None	PPS	720p	Backlit	Finger-print Reader	None	dTPM 2.0	3-cell(24Wh) + 3-cell(24Wh)	45W	Win10 Pro 64	3-year, Depot	01/17
20HD000WUS	US	i5-7200U	No	Intel HD 620	8GBx1	14" FHD (1920x1080) IPS	None	256GB SSD PCIe NVMe Opal2	None	Intel 8265 ac, 2x2 + BT4.1	WWAN Upgradable	None	None	None	None	PPS	720p	Backlit	Finger-print Reader	None	dTPM 2.0	3-cell(24Wh) + 3-cell(24Wh)	45W	Win10 Pro 64	3-year, Depot	01/17
20HD000XUS	US	i5-7300U	vPro	Intel HD 620	8GBx1	14" FHD (1920x1080) IPS	None	500GB 7200rpm	None	Intel 8265 ac, 2x2 + BT4.1	WWAN Upgradable	None	None	None	None	PPS	720p	Backlit	Finger-print Reader	None	dTPM 2.0	3-cell(24Wh) + 3-cell(24Wh)	45W	Win10 Pro 64	3-year, Depot	01/17



ThinkPad T470s Platform Specifications

Product Specifications Reference (PSREF)

Processor	6th Generation Intel® Core™ i5 / i7 Processor								Dimensions Weight Case color Case material	<i>WxDxH:</i> 13.03" x 8.93" x 0.67-0.74"; 331mm x 226.8mm x 16.9-18.8mm From 2.9 lb (1.32kg) Black or Silver <i>Display cover:</i> CFRP Hybrid; <i>Bottom:</i> Magnesium
	Processor Number	# of Cores	# of Threads	Base Frequency	Max Turbo Frequency	Cache	Memory Types	Processor Graphics		
	i5-6300U	2	4	2.4 GHz	3.0 GHz	3MB	DDR4-2133	Intel HD Graphics 520	Smart card reader Media reader Ports	<i>Optional:</i> Smart card reader 4-in-1 reader (MMC, SD, SDHC, SDXC) Three USB 3.1 Gen 1 / USB 3.0 (one Always On), USB 3.1 Type-C Gen 2 / Thunderbolt 3 / DisplayPort 1.2a / Power Delivery 2.0, HDMI 1.4b, Ethernet (RJ-45), Dock connector ThinkPad WiGig dock, mutually exclusive with WWAN WiGig dock (<i>opt</i>) Monitor cable (<i>optional</i>)
	i7-6600U			2.6 GHz	3.4 GHz	4MB				
	or 7th Generation Intel Core i5 / i7 Processor									
	Processor Number	# of Cores	# of Threads	Base Frequency	Max Turbo Frequency	Cache	Memory Types	Processor Graphics		
	i5-7200U	2	4	2.5 GHz	3.1 GHz	3MB	DDR4-2133	Intel HD Graphics 620	Camera (<i>optional</i>) Audio support	HD720p resolution, fixed focus HD Audio, Realtek® ALC3268 codec / stereo speakers, 1W x 2 / dual array microphone, combo audio/microphone jack
	i5-7300U			2.6 GHz	3.5 GHz	3MB				
	i7-7500U			2.7 GHz	3.5 GHz	4MB				
	i7-7600U			2.8 GHz	3.9 GHz	4MB				
Graphics	Intel HD Graphics 520 or 620 in processor; supports external digital monitor via HDMI or USB Type-C; supports three independent displays; Max resolution: 4096x2304@60Hz (USB Type-C); 4096x2160@24Hz (HDMI)								Keyboard UltraNav™	6-row, spill-resistant, multimedia Fn keys, optional LED backlight TrackPoint® pointing device and buttonless Mylar surface multi-touch touchpad
Chipset Memory	Intel SoC (System on Chip) platform 20GB or 24GB max ⁷ / 2400MHz DDR4, dual-channel capable, 4GB or 8GB memory soldered to systemboard, one DDR4 SO-DIMM socket * System clocks down for processors with lower memory controller								Security Security chip	Power-on password, hard disk password, supervisor password, security keyhole <i>Win7 model:</i> discrete TPM 1.2, TCG Certified <i>Win10 model:</i> discrete TPM 2.0, TCG Certified
Display	<i>Some:</i> 14.0" (355mm) FHD (1920x1080), anti-glare, LED backlight, IPS, 250 nits, 16:9 aspect ratio, 700:1 contrast ratio, 160° viewing angle <i>Some:</i> 14.0" (355mm) WQHD (2560x1440), anti-glare, LED backlight, IPS, 300 nits, 16:9 aspect ratio, 700:1 contrast ratio, 160° viewing angle								vPro (<i>optional</i>) Fingerprint reader NFC (<i>optional</i>)	Intel vPro Technology <i>Optional:</i> Touch style match on chip fingerprint reader on the palm rest Near Field Communication
Multi-touch (<i>opt</i>)	On-cell touch, supports 10-finger gesture, 250 nits (FHD only)								Internal battery Max battery life AC adapter	Front Li-Polymer 3-cell (23Wh) and rear Li-Ion 3-cell (26Wh), both Integrated <i>MobileMark® 2014:</i> up to 10.5 hr 45W AC adapter (slim tip), 45W or 65W USB Type-C AC adapter
Storage	<i>Some:</i> M.2 SSD / SATA 6.0Gb/s (e.g. xxxG SSD) <i>Some:</i> M.2 SSD / PCIe NVMe, PCIe 3.0 x 4, 32Gb/s (e.g. xxxG SSD PCIe NVMe)								Preload	Windows® 7 Professional 64 preinstalled Windows 10 Pro 64 • Lenovo Solution Center • Lenovo PowerEngage • ThinkVantage Product Recovery • ThinkVantage System Update • Adobe® Reader® • Microsoft® Office preloaded; purchase a product key to activate • McAfee® LiveSafe™ (30-day trial)
Optical	None									<i>Some:</i> Windows 10 Home 64 <i>Some:</i> Windows 10 Pro 64 • Lenovo Companion • Lenovo Setting • Microsoft Office preloaded; purchase a product key to activate
Ethernet	<i>Non-vPro model:</i> Intel Ethernet Connection I219-V (Jacksonville) <i>vPro model:</i> Intel Ethernet Connection I219-LM (Jacksonville)									
WLAN	<i>One of the following, configurable by model (WiGig is mutually exclusive with WWAN):</i> • Intel Dual Band Wireless-AC 8260, Wi-Fi 2x2 802.11ac + BT4.1, M.2 card • Intel Dual Band Wireless-AC 8265, Wi-Fi 2x2 802.11ac + BT4.1, M.2 card • Intel Tri-Band Wireless-AC 18265, WiGig 802.11ad + Wi-Fi 2x2 802.11ac + BT4.1, M.2 card									
Bluetooth™	Bluetooth 4.1 wireless, integrated in Wi-Fi + Bluetooth combo adapter * Intel 8265ac / 18265ac card support BT4.2 but is limited to BT4.1 by Windows OS								Limited warranty	<i>One of the following, configurable by model:</i> • 1-year depot repair service • 3-year/1-yr battery depot repair service • 3-year/1-yr battery limited onsite service
WWAN (<i>optional</i>)	<i>One of the following, configurable by model (mutually exclusive with WiGig):</i> • Wireless WAN upgradable • Integrated Mobile Broadband 4G LTE-A, Qualcomm® Snapdragon™ X7 LTE-A (Sierra Wireless EM7455), M.2 card								Mil-Spec test	MIL-STD-810G military certification
SIM card (<i>opt</i>)	• Micro-SIM card slot, opt Verizon LTE (US) or Lenovo® Connect (EMEA) SIM card								Environment	EPEAT™ Gold (US only); ENERGY STAR® 6.1; RoHS-compliant

Model	Region	Processor	vPro	Graphics	Memory (Soldered +DIMM)	Display	Multi-touch	Storage(HDD/SSD)	Optical	WLAN + Bluetooth	WWAN	SIM Card	Smart Card Reader	Dock	Monitor Cable	Color	Camera	Key-board	Finger-print Reader	NFC	TPM	Battery (internal)	Power Adapter	OS	Warranty	Ann Date (m/y)
20HF0010US	US	i7-7600U	vPro	Intel HD 620	4GB + 8GB	14" WQHD (2560x1440) IPS	None	512GB SSD M.2 PCIe NVMe Opal2	None	Intel 8265 ac, 2x2 + BT4.1	WWAN Upgradable	None	None	None	None	Black	720p	Backlit	Finger-print Reader	None	dTPM 2.0	3-cell(23Wh) + 3-cell(26Wh)	45W	Win10 Pro	3-year, 64 Depot	02/17
20HF0011US	US	i5-7300U	vPro	Intel HD 620	4GB + 4GB	14" FHD (1920x1080) IPS	None	256GB SSD M.2 PCIe NVMe Opal2	None	Intel 8265 ac, 2x2 + BT4.1	WWAN Upgradable	None	None	None	None	Black	720p	Backlit	Finger-print Reader	None	dTPM 2.0	3-cell(23Wh) + 3-cell(26Wh)	45W	Win10 Pro	3-year, 64 Depot	02/17
20HF0012US	US	i5-7300U	vPro	Intel HD 620	4GB + 4GB	14" FHD (1920x1080) IPS	10-point Multi-touch	256GB SSD M.2 PCIe NVMe Opal2	None	Intel 8265 ac, 2x2 + BT4.1	WWAN Upgradable	None	None	None	None	Black	720p	Backlit	Finger-print Reader	None	dTPM 2.0	3-cell(23Wh) + 3-cell(26Wh)	45W	Win10 Pro	3-year, 64 Depot	02/17
20HF0013US	US	i7-7600U	vPro	Intel HD 620	4GB + 4GB	14" FHD (1920x1080) IPS	None	256GB SSD M.2 PCIe NVMe Opal2	None	Intel 8265 ac, 2x2 + BT4.1	WWAN Upgradable	None	None	None	None	Black	720p	Backlit	Finger-print Reader	None	dTPM 2.0	3-cell(23Wh) + 3-cell(26Wh)	45W	Win10 Pro	3-year, 64 Depot	02/17
20HF0014US	US	i5-7200U	No	Intel HD 620	4GB Soldered	14" FHD (1920x1080) IPS	None	128GB SSD M.2	None	Intel 8265 ac, 2x2 + BT4.1	WWAN Upgradable	None	None	None	None	Black	720p	Backlit	Finger-print Reader	None	dTPM 2.0	3-cell(23Wh) + 3-cell(26Wh)	45W	Win10 Pro	1-year, 64 Depot	02/17
20HF0015US	US	i7-7600U	vPro	Intel HD 620	4GB + 4GB	14" FHD (1920x1080) IPS	10-point Multi-touch	256GB SSD M.2 PCIe NVMe Opal2	None	Intel 8265 ac, 2x2 + BT4.1	WWAN Upgradable	None	None	None	None	Black	720p	Backlit	Finger-print Reader	None	dTPM 2.0	3-cell(23Wh) + 3-cell(26Wh)	45W	Win10 Pro	3-year, 64 Depot	02/17
20HF003QUS	US	i7-7600U	vPro	Intel HD 620	4GB + 8GB	14" WQHD (2560x1440) IPS	None	512GB SSD M.2 PCIe NVMe Opal2	None	Intel 8265 ac, 2x2 + BT4.1	WWAN Upgradable	None	None	None	None	Silver	720p	Backlit	Finger-print Reader	None	dTPM 2.0	3-cell(23Wh) + 3-cell(26Wh)	45W	Win10 Pro	3-year, 64 Depot	02/17
20HF003TUS	US	i7-7600U	vPro	Intel HD 620	4GB + 4GB	14" FHD (1920x1080) IPS	None	256GB SSD M.2 PCIe NVMe Opal2	None	Intel 8265 ac, 2x2 + BT4.1	WWAN Upgradable	None	None	None	None	Silver	720p	Backlit	Finger-print Reader	None	dTPM 2.0	3-cell(23Wh) + 3-cell(26Wh)	45W	Win10 Pro	3-year, 64 Depot	02/17
20HF003UUS	US	i5-7300U	vPro	Intel HD 620	4GB + 4GB	14" FHD (1920x1080) IPS	10-point Multi-touch	256GB SSD M.2 PCIe NVMe Opal2	None	Intel 8265 ac, 2x2 + BT4.1	WWAN Upgradable	None	None	None	None	Silver	720p	Backlit	Finger-print Reader	None	dTPM 2.0	3-cell(23Wh) + 3-cell(26Wh)	45W	Win10 Pro	3-year, 64 Depot	02/17
20HF003VUS	US	i5-7200U	No	Intel HD 620	4GB Soldered	14" FHD (1920x1080) IPS	None	128GB SSD M.2	None	Intel 8265 ac, 2x2 + BT4.1	WWAN Upgradable	None	None	None	None	Silver	720p	Backlit	Finger-print Reader	None	dTPM 2.0	3-cell(23Wh) + 3-cell(26Wh)	45W	Win10 Pro	1-year, 64 Depot	02/17
20HF003WUS	US	i5-7300U	vPro	Intel HD 620	4GB + 4GB	14" FHD (1920x1080) IPS	None	256GB SSD M.2 PCIe NVMe Opal2	None	Intel 8265 ac, 2x2 + BT4.1	WWAN Upgradable	None	None	None	None	Silver	720p	Backlit	Finger-print Reader	None	dTPM 2.0	3-cell(23Wh) + 3-cell(26Wh)	45W	Win10 Pro	3-year, 64 Depot	02/17



ThinkPad T560 Platform Specifications

Product Specifications Reference (PSREF)

Processor	6th Generation Intel® Core™ i5 / i7 Processor								Smart card reader	Optional: Smart card reader																				
	Processor Number	# of Cores	# of Threads	Base Frequency	Max Turbo Frequency	Cache	Memory Types	Processor Graphics	Media reader	4-in-1 reader (MMC, SD, SDHC, SDXC)																				
	i5-6200U	2	4	2.3 GHz	2.8 GHz	3MB	DDR3L-1600	Intel HD Graphics 520	Ports	Three USB 3.0 (one Always On), MiniDP, HDMI, Ethernet (RJ-45), Dock connector																				
	i5-6300U			2.4 GHz	3 GHz	3MB																								
	i7-6500U			2.5 GHz	3.1 GHz	4MB																								
i7-6600U	2.6 GHz			3.4 GHz	4MB																									
Camera	Optional: HD720p resolution, low light sensitive, fixed focus																													
Audio support	HD Audio, Realtek® ALC3245 codec / stereo speakers, 1W x 2 / dual array microphone, combo audio/microphone jack																													
Keyboard	6-row, spill-resistant, multimedia Fn keys, numeric keypad, optional LED backlight																													
UltraNav™	TrackPoint® pointing device and buttonless Mylar surface touchpad, multi-touch																													
Graphics	Intel HD Graphics 520 in processor only, or Intel HD Graphics 520 in processor and NVIDIA GeForce® 940MX, 2GB memory; supports external digital monitor via HDMI or Mini DisplayPort; supports three independent displays; Max resolution: 3840x2160@60Hz (DisplayPort via Mini DisplayPort cable); 4096x2160@24Hz (HDMI)								Security	Power-on password, hard disk password, supervisor password, security keyhole																				
Chipset	Intel SoC (System on Chip) platform								Security chip	Discrete TPM 1.2 TCG Certified and Firmware TPM 2.0 integrated in chipset																				
Memory	32GB max ⁷ / PC3-12800 1600MHz DDR3L, non-parity, dual-channel capable, two DDR3L SO-DIMM sockets								ThinkEngine	Delivers improved thermal and power efficiency, up to 30 day standby, faster resume time, enhanced security, as well as anti-tampering measures																				
Display	<i>Some:</i> 15.6" (396mm) HD (1366x768), anti-glare, LED backlight, 220 nits, 16:9 aspect ratio, 400:1 contrast ratio <i>Some:</i> 15.6" (396mm) FHD (1920x1080), anti-glare, LED backlight, IPS, 250 nits, 16:9 aspect ratio, 600:1 contrast ratio, 160° viewing angle <i>Some:</i> 15.5" (394mm) 3K (2880x1620), anti-glare, LED backlight, IPS, 350 nits, 16:9 aspect ratio, 1000:1 contrast ratio, 160° viewing angle								vPro (optional)	Intel vPro Technology																				
Multi-touch (opt)	In-cell touch, supports 10-finger gesture								Fingerprint reader	Optional: Swipe style fingerprint reader on the palm rest																				
Storage	<i>Some:</i> SSD / SATA 6.0Gb/s (e.g. xxxG SSD) <i>Some:</i> SSD / PCIe NVMe, PCIe 3.0 x 2, 16Gb/s (e.g. xxxG SSD PCIe NVMe) <i>Some:</i> HDD / SATA 6.0Gb/s, 2.5" wide, 7mm high, Shock Mounted Hard Drive, Active Protection System™ <i>Some:</i> SSHD with 8GB NAND flash memory								Internal battery	Optional: Integrated Li-Polymer 3-cell (44Wh)																				
Optical	None								External battery	Li-Ion or Li-Polymer 3-cell (23Wh) or Li-Ion 6-cell (48Wh or 72Wh)																				
Ethernet	<i>Non-vPro model:</i> Intel Ethernet Connection I219-V (Jacksonville) <i>vPro model:</i> Intel Ethernet Connection I219-LM (Jacksonville)								Max battery life ¹⁰ (MobileMark® 2014)	<table border="1"> <thead> <tr> <th>Models</th> <th>3 + 3-cell</th> <th>3 + 6-cell 48Wh</th> <th>3 + 6-cell 72Wh</th> </tr> </thead> <tbody> <tr> <td>Integrated model</td> <td>13.2 hr</td> <td>18.0 hr</td> <td>22.7 hr</td> </tr> <tr> <td>discrete model</td> <td>13.5 hr</td> <td>18.3 hr</td> <td>24.3 hr</td> </tr> </tbody> </table>	Models	3 + 3-cell	3 + 6-cell 48Wh	3 + 6-cell 72Wh	Integrated model	13.2 hr	18.0 hr	22.7 hr	discrete model	13.5 hr	18.3 hr	24.3 hr								
Models	3 + 3-cell	3 + 6-cell 48Wh	3 + 6-cell 72Wh																											
Integrated model	13.2 hr	18.0 hr	22.7 hr																											
discrete model	13.5 hr	18.3 hr	24.3 hr																											
WLAN ⁴	<i>One of the following, configurable by model:</i> • 11ac+BT, Broadcom BCM4356, 2x2, M.2 card • 11ac+BT, Intel Dual Band Wireless-AC 8260, 2x2, M.2 card								AC adapter	45W AC adapter, 65W Slim AC adapter, or 65W AC adapter																				
Bluetooth™	Bluetooth 4.1 wireless, integrated in Wi-Fi + Bluetooth combo adapter								Preload	Windows 7 Professional 64 preinstalled through downgrade rights in Windows 10 Pro 64 • Lenovo Solution Center • Lenovo Companion • Lenovo Setting • ThinkVantage Product Recovery • Rescue and Recovery™ • ThinkVantage System Update • Adobe® Reader® • Microsoft® Office preloaded; purchase a product key to activate • McAfee® LiveSafe™ (30-day trial)																				
WWAN (optional)	<i>One of the following, configurable by model:</i> • Wireless WAN upgradable • Wireless WAN, Sierra Wireless EM7455, Qualcomm® 4G LTE-Advanced/DC-HSPA+/HSPA+/HSPA/UMTS/GNSS, M.2 card • Wireless WAN, HUAWEI ME906S, HUAWEI 4G LTE/WCDMA/HSPA/GSM/GPRS/EDGE/GNSS, M.2 card (WE only)								Limited warranty ¹²	<i>One of the following, configurable by model:</i> • 1-year depot repair service • 3-year/1-yr battery depot repair service • 3-year/1-yr battery limited onsite service ²⁴ • 3-year/1-yr battery limited onsite service, OID (Onsite International Delivery)																				
SIM card (opt)	Micro-SIM card slot, optional Verizon LTE (US) or Lenovo Connect (WE) SIM card								Mil-Spec test	MIL-STD-810G military certification																				
Dimensions ³	WxDxH: 14.98" x 10.17" x 0.88"; 380.6mm x 258.2mm x 22.45mm								Environment	EPEAT™ Gold (US only); ENERGY STAR® 6.1; GREENGUARD®; RoHS-compliant																				
Weight ²	<table border="1"> <thead> <tr> <th>Models</th> <th>No + 6-cell</th> <th>3-cell + 3-cell</th> <th>3-cell + 6-cell</th> </tr> </thead> <tbody> <tr> <td>Integrated Non-touch</td> <td>5.18 lb / 2.35 kg</td> <td>4.88 lb / 2.22 kg</td> <td>5.35 lb / 2.43 kg</td> </tr> <tr> <td>Integrated Multi-touch</td> <td>-</td> <td>4.92 lb / 2.23 kg</td> <td>5.33 lb / 2.42 kg</td> </tr> <tr> <td>Discrete Non-touch</td> <td>5.27 lb / 2.39 kg</td> <td>4.97 lb / 2.25 kg</td> <td>5.44 lb / 2.47 kg</td> </tr> <tr> <td>Discrete Multi-touch</td> <td>-</td> <td>5.00 lb / 2.27 kg</td> <td>5.42 lb / 2.46 kg</td> </tr> </tbody> </table>								Models	No + 6-cell	3-cell + 3-cell	3-cell + 6-cell	Integrated Non-touch	5.18 lb / 2.35 kg	4.88 lb / 2.22 kg	5.35 lb / 2.43 kg	Integrated Multi-touch	-	4.92 lb / 2.23 kg	5.33 lb / 2.42 kg	Discrete Non-touch	5.27 lb / 2.39 kg	4.97 lb / 2.25 kg	5.44 lb / 2.47 kg	Discrete Multi-touch	-	5.00 lb / 2.27 kg	5.42 lb / 2.46 kg	Case material	<i>Display cover:</i> PPS; <i>Bottom:</i> Glass-Fiber Reinforced Plastic
Models	No + 6-cell	3-cell + 3-cell	3-cell + 6-cell																											
Integrated Non-touch	5.18 lb / 2.35 kg	4.88 lb / 2.22 kg	5.35 lb / 2.43 kg																											
Integrated Multi-touch	-	4.92 lb / 2.23 kg	5.33 lb / 2.42 kg																											
Discrete Non-touch	5.27 lb / 2.39 kg	4.97 lb / 2.25 kg	5.44 lb / 2.47 kg																											
Discrete Multi-touch	-	5.00 lb / 2.27 kg	5.42 lb / 2.46 kg																											

Model	Region	Processor	vPro	Graphics	Memory	Display	Multi-touch	Storage	Optical	WLAN + Bluetooth	WWAN	SIM Card	Smart Card Reader	Camera	Keyboard	Fingerprint Reader	Battery (internal+external)	Power Adapter	Operating System	Warranty	Ann Date (m/y)
20FH001QUS	US	i5-6200U	No	Intel HD 520	4GBx1	15.6" HD (1366x768)	None	500GB 7200rpm	None	Intel 8260 ac, 2x2 + BT4.1	WWAN Upgradable	None	None	720p	Backlit	Fingerprint Reader	3-cell(44Wh) + 3-cell(23Wh)	45W	Win10 DG Win7 Pro 64	3-year, Depot	01/16
20FH001RUS	US	i5-6300U	vPro	Intel HD 520	8GBx1	15.6" FHD (1920x1080) IPS	None	256GB SSD Opal2	None	Intel 8260 ac, 2x2 + BT4.1	WWAN Upgradable	None	None	720p	Backlit	Fingerprint Reader	3-cell(44Wh) + 3-cell(23Wh)	45W	Win10 DG Win7 Pro 64	3-year, Depot	01/16
20FH001SUS	US	i5-6300U	vPro	Intel HD 520	4GBx1	15.6" HD (1366x768)	None	180GB SSD Opal2	None	Intel 8260 ac, 2x2 + BT4.1	WWAN Upgradable	None	None	720p	Backlit	Fingerprint Reader	3-cell(44Wh) + 3-cell(23Wh)	45W	Win10 DG Win7 Pro 64	3-year, Depot	01/16
20FH001TUS	US	i7-6600U	vPro	Intel HD 520	8GBx1	15.6" FHD (1920x1080) IPS	None	256GB SSD Opal2	None	Intel 8260 ac, 2x2 + BT4.1	WWAN Upgradable	None	None	720p	Backlit	Fingerprint Reader	3-cell(44Wh) + 3-cell(23Wh)	45W	Win10 DG Win7 Pro 64	3-year, Depot	01/16
20FH001UUS	US	i5-6300U	vPro	Intel HD 520	4GBx1	15.5" 3K (2880x1620) IPS	None	192GB SSD	None	Intel 8260 ac, 2x2 + BT4.1	WWAN Upgradable	None	None	720p	Backlit	Fingerprint Reader	3-cell(44Wh) + 3-cell(23Wh)	45W	Win10 DG Win7 Pro 64	3-year, Depot	01/16
20FH001VUS	US	i5-6300U	vPro	Intel HD 520	4GBx1	15.6" HD (1366x768)	None	500GB 7200rpm	None	Intel 8260 ac, 2x2 + BT4.1	WWAN Upgradable	None	None	720p	Backlit	Fingerprint Reader	3-cell(44Wh) + 3-cell(23Wh)	45W	Win10 DG Win7 Pro 64	3-year, Depot	01/16
20FH001WUS	US	i7-6600U	vPro	Intel HD 520	8GBx1	15.5" 3K (2880x1620) IPS	None	256GB SSD Opal2	None	Intel 8260 ac, 2x2 + BT4.1	WWAN Upgradable	None	None	720p	Backlit	Fingerprint Reader	3-cell(44Wh) + 3-cell(23Wh)	45W	Win10 DG Win7 Pro 64	3-year, Depot	01/16
20FH001XUS	US	i5-6300U	vPro	Intel HD 520	4GBx1	15.6" FHD (1920x1080) IPS	None	180GB SSD Opal2	None	Intel 8260 ac, 2x2 + BT4.1	WWAN Upgradable	None	None	720p	Backlit	Fingerprint Reader	3-cell(44Wh) + 3-cell(23Wh)	45W	Win10 DG Win7 Pro 64	3-year, Depot	01/16
20FH001YUS	US	i5-6300U	vPro	Intel HD 520	8GBx1	15.6" FHD (1920x1080) IPS	None	180GB SSD Opal2	None	Intel 8260 ac, 2x2 + BT4.1	WWAN Upgradable	None	None	720p	Backlit	Fingerprint Reader	3-cell(44Wh) + 3-cell(23Wh)	45W	Win10 DG Win7 Pro 64	3-year, Depot	01/16
20FH0020US	US	i5-6300U	vPro	Intel HD 520	4GBx1	15.6" HD (1366x768)	None	256GB SSD Opal2	None	Intel 8260 ac, 2x2 + BT4.1	WWAN Upgradable	None	None	720p	Backlit	Fingerprint Reader	3-cell(44Wh) + 3-cell(23Wh)	45W	Win10 DG Win7 Pro 64	3-year, Depot	01/16
20FH0021US	US	i5-6300U	vPro	Intel HD 520	8GBx1	15.5" 3K (2880x1620) IPS	None	256GB SSD Opal2	None	Intel 8260 ac, 2x2 + BT4.1	WWAN Upgradable	None	None	720p	Backlit	Fingerprint Reader	3-cell(44Wh) + 3-cell(23Wh)	45W	Win10 DG Win7 Pro 64	3-year, Depot	01/16
20FH002CUS	US	i5-6300U	vPro	Intel HD 520	8GBx1	15.6" FHD (1920x1080) IPS	None	256GB SSD Opal2	None	Intel 8260 ac, 2x2 + BT4.1	WWAN Upgradable	None	None	720p	Backlit	Fingerprint Reader	3-cell(44Wh) + 3-cell(23Wh)	45W	Win10 Pro 64	3-year, Depot	01/16
20FH002DUS	US	i5-6300U	vPro	Intel HD 520	8GBx1	15.6" FHD (1920x1080) IPS	10-point Multi-touch	256GB SSD Opal2	None	Intel 8260 ac, 2x2 + BT4.1	WWAN Upgradable	None	None	720p	Backlit	Fingerprint Reader	3-cell(44Wh) + 3-cell(23Wh)	45W	Win10 Pro 64	3-year, Depot	01/16
20FH002EUS	US	i5-6200U	No	Intel HD 520	4GBx1	15.6" HD (1366x768)	None	192GB SSD	None	Intel 8260 ac, 2x2 + BT4.1	WWAN Upgradable	None	None	720p	Backlit	Fingerprint Reader	3-cell(44Wh) + 3-cell(23Wh)	45W	Win10 DG Win7 Pro 64	3-year, Depot	01/16
20FH002FUS	US	i7-6600U	vPro	Intel HD 520	8GBx2	15.6" FHD (1920x1080) IPS	10-point Multi-touch	512GB SSD	None	Intel 8260 ac, 2x2 + BT4.1	WWAN Upgradable	None	None	720p	Backlit	Fingerprint Reader	3-cell(44Wh) + 3-cell(23Wh)	45W	Win10 Pro 64	3-year, Depot	01/16
20FH002GUS	US	i5-6200U	No	Intel HD 520	4GBx1	15.6" HD (1366x768)	None	500GB 7200rpm	None	Intel 8260 ac, 2x2 + BT4.1	WWAN Upgradable	None	None	720p	Backlit	Fingerprint Reader	3-cell(44Wh) + 3-cell(23Wh)	45W	Win10 Pro 64	3-year, Depot	01/16
20FH002HUS	US	i7-6600U	vPro	Intel HD 520	8GBx2	15.6" FHD (1920x1080) IPS	None	512GB SSD	None	Intel 8260 ac, 2x2 + BT4.1	WWAN Upgradable	None	None	720p	Backlit	Fingerprint Reader	3-cell(44Wh) + 3-cell(23Wh)	45W	Win10 Pro 64	3-year, Depot	01/16
20FH002JUS	US	i7-6600U	vPro	Intel HD 520	8GBx2	15.5" 3K (2880x1620) IPS	None	512GB SSD	None	Intel 8260 ac, 2x2 + BT4.1	WWAN Upgradable	None	None	720p	Backlit	Fingerprint Reader	3-cell(44Wh) + 3-cell(23Wh)	45W	Win10 Pro 64	3-year, Depot	01/16
20FH002KUS	US	i7-6600U	vPro	Intel HD 520	8GBx2	15.5" 3K (2880x1620) IPS	None	512GB SSD	None	Intel 8260 ac, 2x2 + BT4.1	WWAN Upgradable	None	None	720p	Backlit	Fingerprint Reader	3-cell(44Wh) + 3-cell(23Wh)	45W	Win10 DG Win7 Pro 64	3-year, Depot	01/16
20FH002LUS	US	i7-6600U	vPro	Intel HD 520	8GBx1	15.6" FHD (1920x1080) IPS	None	256GB SSD Opal2	None	Intel 8260 ac, 2x2 + BT4.1	WWAN Upgradable	None	None	720p	Backlit	Fingerprint Reader	3-cell(44Wh) + 3-cell(23Wh)	45W	Win10 Pro 64	3-year, Depot	01/16

Model	Region	Processor	vPro	Graphics	Memory	Display	Multi-touch	Storage	Optical	WLAN + Bluetooth	WWAN	SIM Card	Smart Card Reader	Camera	Keyboard	Fingerprint Reader	Battery (internal+external)	Power Adapter	Operating System	Warranty	Ann Date (m/y)
20FH002MUS	US	i5-6200U	No	Intel HD 520	4GBx1	15.6" HD (1366x768)	None	192GB SSD	None	Intel 8260 ac, 2x2 + BT4.1	WWAN Upgradable	None	None	720p	Backlit	Fingerprint Reader	3-cell(44Wh) + 3-cell(23Wh)	45W	Win10 Pro 64	3-year, Depot	01/16
20FH002NUS	US	i7-6600U	vPro	Intel HD 520	8GBx2	15.6" FHD (1920x1080) IPS	None	512GB SSD	None	Intel 8260 ac, 2x2 + BT4.1	WWAN Upgradable	None	None	720p	Backlit	Fingerprint Reader	3-cell(44Wh) + 3-cell(23Wh)	45W	Win10 DG Win7 Pro 64	3-year, Depot	01/16
20FH002WUS	US	i7-6600U	vPro	940MX 2GB	8GBx1	15.6" FHD (1920x1080) IPS	None	512GB SSD	None	Intel 8260 ac, 2x2 + BT4.1	WWAN Upgradable	None	None	720p	Backlit	Fingerprint Reader	3-cell(44Wh) + 3-cell(23Wh)	65W	Win10 DG Win7 Pro 64	3-year, Depot	04/16
20FH002XUS	US	i7-6600U	vPro	940MX 2GB	8GBx1	15.5" 3K (2880x1620) IPS	None	512GB SSD	None	Intel 8260 ac, 2x2 + BT4.1	WWAN Upgradable	None	None	720p	Backlit	Fingerprint Reader	3-cell(44Wh) + 3-cell(23Wh)	65W	Win10 DG Win7 Pro 64	3-year, Depot	04/16
20FH002YUS	US	i7-6600U	vPro	940MX 2GB	8GBx1	15.6" FHD (1920x1080) IPS	None	256GB SSD Opal2	None	Intel 8260 ac, 2x2 + BT4.1	WWAN Upgradable	None	None	720p	Backlit	Fingerprint Reader	3-cell(44Wh) + 3-cell(23Wh)	65W	Win10 DG Win7 Pro 64	3-year, Depot	04/16
20FH0030US	US	i5-6300U	vPro	940MX 2GB	8GBx1	15.6" FHD (1920x1080) IPS	None	256GB SSD Opal2	None	Intel 8260 ac, 2x2 + BT4.1	WWAN Upgradable	None	None	720p	Backlit	Fingerprint Reader	3-cell(44Wh) + 3-cell(23Wh)	65W	Win10 DG Win7 Pro 64	3-year, Depot	04/16
20FH0031US	US	i7-6600U	vPro	940MX 2GB	8GBx1	15.5" 3K (2880x1620) IPS	None	256GB SSD Opal2	None	Intel 8260 ac, 2x2 + BT4.1	WWAN Upgradable	None	None	720p	Backlit	Fingerprint Reader	3-cell(44Wh) + 3-cell(23Wh)	65W	Win10 DG Win7 Pro 64	3-year, Depot	04/16
20FH0032US	US	i5-6300U	vPro	940MX 2GB	8GBx1	15.6" FHD (1920x1080) IPS	None	512GB SSD	None	Intel 8260 ac, 2x2 + BT4.1	WWAN Upgradable	None	None	720p	Backlit	Fingerprint Reader	3-cell(44Wh) + 3-cell(23Wh)	65W	Win10 DG Win7 Pro 64	3-year, Depot	04/16
20FH003BUS	US	i5-6300U	vPro	Intel HD 520	8GBx1	15.6" FHD (1920x1080) IPS	None	500GB 7200rpm	None	Intel 8260 ac, 2x2 + BT4.1	WWAN Upgradable	None	None	720p	Backlit	Fingerprint Reader	3-cell(44Wh) + 3-cell(23Wh)	45W	Win10 DG Win7 Pro 64	3-year, Depot	07/16
20FH0043US	US	i5-6200U	No	Intel HD 520	8GBx1	15.6" FHD (1920x1080) IPS	10-point Multi-touch	256GB SSD Opal2	None	Intel 8260 ac, 2x2 + BT4.1	WWAN Upgradable	None	None	720p	Backlit	Fingerprint Reader	3-cell(44Wh) + 3-cell(23Wh)	45W	Win10 Pro 64	3-year, Depot	10/16
20FH0044US	US	i5-6300U	vPro	Intel HD 520	4GBx1	15.5" 3K (2880x1620) IPS	None	180GB SSD Opal2	None	Intel 8260 ac, 2x2 + BT4.1	WWAN Upgradable	None	None	720p	Backlit	Fingerprint Reader	3-cell(44Wh) + 3-cell(23Wh)	45W	Win10 DG Win7 Pro 64	3-year, Depot	11/16
20FH0045US	US	i5-6200U	No	Intel HD 520	4GBx1	15.6" HD (1366x768)	None	256GB SSD Opal2	None	Intel 8260 ac, 2x2 + BT4.1	WWAN Upgradable	None	None	720p	Backlit	Fingerprint Reader	3-cell(44Wh) + 3-cell(23Wh)	45W	Win10 Pro 64	3-year, Depot	11/16
20FH0046US	US	i5-6200U	No	Intel HD 520	4GBx1	15.6" HD (1366x768)	None	180GB SSD Opal2	None	Intel 8260 ac, 2x2 + BT4.1	WWAN Upgradable	None	None	720p	Backlit	Fingerprint Reader	3-cell(44Wh) + 3-cell(23Wh)	45W	Win10 Pro 64	3-year, Depot	11/16
20FH0047US	US	i5-6200U	No	Intel HD 520	4GBx1	15.6" HD (1366x768)	None	180GB SSD Opal2	None	Intel 8260 ac, 2x2 + BT4.1	WWAN Upgradable	None	None	720p	Backlit	Fingerprint Reader	3-cell(44Wh) + 3-cell(23Wh)	45W	Win10 DG Win7 Pro 64	3-year, Depot	11/16
20FH0048US	US	i5-6200U	No	Intel HD 520	4GBx1	15.6" HD (1366x768)	None	256GB SSD Opal2	None	Intel 8260 ac, 2x2 + BT4.1	WWAN Upgradable	None	None	720p	Backlit	Fingerprint Reader	3-cell(44Wh) + 3-cell(23Wh)	45W	Win10 DG Win7 Pro 64	3-year, Depot	11/16
20FH0049US	US	i5-6300U	vPro	Intel HD 520	4GBx1	15.5" 3K (2880x1620) IPS	None	256GB SSD Opal2	None	Intel 8260 ac, 2x2 + BT4.1	WWAN Upgradable	None	None	720p	Backlit	Fingerprint Reader	3-cell(44Wh) + 3-cell(23Wh)	45W	Win10 DG Win7 Pro 64	3-year, Depot	11/16
20FHA01KUS	US	i5-6300U	vPro	Intel HD 520	8GBx1	15.6" FHD (1920x1080) IPS	None	500GB 7200rpm	None	Intel 8260 ac, 2x2 + BT4.1	WWAN Upgradable	None	None	720p	Backlit	Fingerprint Reader	3-cell(44Wh) + 3-cell(23Wh)	45W	Win10 Pro 64	3-year, Depot	07/16



ThinkPad T570 Platform Specifications

Product Specifications Reference (PSREF)

Processor	6th Generation Intel® Core™ i5 / i7 Processor							Dimensions Weight	WxDxH: 14.40" x 9.95" x 0.79-0.80"; 365.8mm x 252.8mm x 19.95-20.2mm				
	Processor Number	# of Cores	# of Threads	Base Frequency	Max Turbo Frequency	Cache	Memory Types		Processor Graphics	Models	4 + 3-cell	6-cell	4 + 6-cell
	i5-6300U	2	4	2.4 GHz	3.0 GHz	3MB	DDR4-2133	Intel HD Graphics 520	Integrated Non-touch	4.30 lb / 1.95 kg	4.70 lb / 2.13 kg	4.70 lb / 2.13 kg	
	i7-6600U			2.6 GHz	3.4 GHz	4MB			Integrated Multi-touch	4.34 lb / 1.97 kg	4.75 lb / 2.16 kg	4.75 lb / 2.16 kg	
	or 7th Generation Intel Core i5 / i7 Processor							Case color Case material	Black Display cover: Glass-Fiber Reinforced Plastic (PPS); Bottom: Glass-Fiber Reinforced Plastic				
	Processor Number	# of Cores	# of Threads	Base Frequency	Max Turbo Frequency	Cache	Memory Types		Processor Graphics	Discrete Non-touch	4.39 lb / 1.99 kg	4.80 lb / 2.18 kg	4.80 lb / 2.18 kg
	i5-7200U	2	4	2.5 GHz	3.1 GHz	3MB	DDR4-2133	Intel HD Graphics 620	Discrete Multi-touch	4.44 lb / 2.01 kg	4.85 lb / 2.20 kg	4.85 lb / 2.20 kg	
	i5-7300U			2.6 GHz	3.5 GHz	3MB							
	i7-7500U			2.7 GHz	3.5 GHz	4MB							
	i7-7600U			2.8 GHz	3.9 GHz	4MB							
Graphics	Intel HD Graphics 520 or 620 in processor only, or Intel HD Graphics 520 or 620 in processor and NVIDIA GeForce® 940MX, 2GB 2.5GHz GDDR5 memory; supports external digital monitor via HDMI or USB Type-C; supports three independent displays; Max resolution: 4096x2304@60Hz (USB Type-C); 4096x2160@24Hz (HDMI)							Smart card reader	Optional: Smart card reader				
Chipset	Intel SoC (System on Chip) platform							Media reader	SD 3.0, UHS-I				
Memory	32GB max / 2400MHz DDR4, dual-channel capable, two DDR4 SO-DIMM sockets * System clocks down for processors with lower memory controller							Ports	Three USB 3.1 Gen 1 / USB 3.0 (one Always On), USB 3.1 Type-C Gen 2 / Thunderbolt 3 / DisplayPort 1.2a / Power Delivery 2.0, HDMI 1.4b, Ethernet (RJ-45), Dock connector				
Display	Some: 15.6" (396mm) HD (1366x768), anti-glare, LED backlight, 220 nits, 16:9 aspect ratio, 400:1 contrast ratio Some: 15.6" (396mm) FHD (1920x1080), anti-glare, LED backlight, IPS, 250 nits, 16:9 aspect ratio, 700:1 contrast ratio, 170° viewing angle Some: 15.6" (396mm) 4K (3840x2160), anti-glare, LED backlight, IPS, 300 nits, 16:9 aspect ratio, 1000:1 contrast ratio, 72% gamut, 170° viewing angle							WiGig dock (opt)	ThinkPad WiGig dock				
Multi-touch (opt)	On-cell touch, supports 10-finger gesture (FHD only)							Monitor cable (optional)	HDMI to VGA: Lenovo HDMI to VGA Monitor Adapter USB-C to VGA: Lenovo USB-C to VGA Adapter				
Storage	System has one HDD slot or one M.2 2280 slot exclusively for storage Some: HDD / SATA 6.0Gb/s, 2.5" wide, 7mm high, Active Protection System™ Some: SSD / SATA 6.0Gb/s, 2.5" wide, 7mm high (e.g. xxxGB SSD) Some: M.2 SSD / PCIe NVMe, PCIe 3.0 x 2, 16Gb/s Some: 128GB M.2 SSD / SATA 6.0Gb/s, in WWAN slot as 2nd Storage, mutually exclusive with WiGig Some: 16GB Intel Optane™ memory, PCIe NVMe, PCIe 3.0 x 2, 16Gb/s, in WWAN slot as storage cache for HDD, mutually exclusive with WiGig							Camera (optional)	720p: HD720p resolution, fixed focus IR & 720p: IR camera and HD720p camera (mutually exclusive with WiGig)				
Optical	None							Audio support	HD Audio, Realtek ALC3268 codec / stereo speakers, 2W x 2 / dual array microphone, combo audio/microphone jack				
Ethernet	Non-vPro model: Intel Ethernet Connection I219-V (Jacksonville) vPro model: Intel Ethernet Connection I219-LM (Jacksonville)							Keyboard	6-row, spill-resistant, multimedia Fn keys, numeric keypad, optional LED backlight				
WLAN	One of the following, configurable by model (WiGig can coexist with WWAN): • Realtek® RTL8822BE, Wi-Fi 2x2 802.11ac + BT4.1, M.2 card • Intel Dual Band Wireless-AC 8260, Wi-Fi 2x2 802.11ac + BT4.1, M.2 card • Intel Dual Band Wireless-AC 8265, Wi-Fi 2x2 802.11ac + BT4.1, M.2 card • Intel Tri-Band Wireless-AC 18265, WiGig 802.11ad + Wi-Fi 2x2 802.11ac + BT4.1, M.2 card							UltraNav™	TrackPoint® pointing device and buttonless Mylar surface multi-touch touchpad				
Bluetooth™	Bluetooth 4.1 wireless, integrated in Wi-Fi + Bluetooth combo adapter * Intel 8265ac / 18265ac card support BT4.2 but is limited to BT4.1 by Windows OS							Security	Power-on password, hard disk password, supervisor password, security keyhole				
WWAN (optional)	One of the following, configurable by model (WWAN can coexist with WiGig): • Wireless WAN upgradable • Integrated Mobile Broadband 4G LTE-A, Qualcomm® Snapdragon™ X7 LTE-A (Sierra Wireless EM7455), M.2 card • Integrated Mobile Broadband 4G LTE, Intel XMM™ 7160 (Fibocom L831-EAU), M.2 card (EMEA only)							Security chip	Win7 model: discrete TPM 1.2, TCG Certified Win10 model: discrete TPM 2.0, TCG Certified				
SIM card (opt)	Micro-SIM card slot, opt Verizon LTE (US) or Lenovo® Connect (EMEA) SIM card							vPro (optional)	Intel vPro Technology				
							Fingerprint reader	Optional: Touch style match on chip fingerprint reader on the palm rest					
							NFC (optional)	Near Field Communication					
							Internal battery	Optional: Integrated Li-Polymer 4-cell (32Wh)					
							External battery	Li-Polymer 3-cell (24Wh) or Li-Ion 6-cell (48Wh or 72Wh)					
							Max battery life (MobileMark® 2014)	Models	4 + 3-cell	6-cell 48Wh	6-cell 72Wh	4 + 6-cell 48Wh	4 + 6-cell 72Wh
								Integrated	13.8 hr	12.5 hr	18.5 hr	20.3 hr	21.1 hr
								discrete	13.8 hr	12.5 hr	18.5 hr	20.0 hr	26.8 hr
							AC adapter	45W or 65W AC adapter (slim tip), 45W or 65W USB Type-C AC adapter					
							Preload	Windows® 7 Professional 64 preinstalled through downgrade rights in Windows 10 Pro 64	Some: Windows 10 Home 64 Some: Windows 10 Pro 64				
								• Lenovo Solution Center	• Lenovo Companion				
								• Lenovo PowerEngage	• Lenovo Setting				
								• ThinkVantage Product Recovery	• Microsoft Office preloaded; purchase a product key to activate				
								• ThinkVantage System Update					
								• Adobe® Reader®					
								• Microsoft® Office preloaded; purchase a product key to activate					
								• McAfee® LiveSafe™ (30-day trial)					
							Limited warranty	One of the following, configurable by model: • 1-year depot repair service • 3-year/1-yr battery depot repair service • 3-year/1-yr battery limited onsite service					
							Mil-Spec test	MIL-STD-810G military certification					
							Environment	EPEAT™ Gold (US only); ENERGY STAR® 6.1; RoHS-compliant					

ThinkPad T570 - TopSeller - 20H9

Model	Region	Processor	vPro	Graphics	Memory	Display	Multi-touch	Storage(HDD/SSD)	Optical	WLAN + Bluetooth	WWAN	SIM Card	Smart Card Reader	Dock	Monitor Cable	Camera	Key-board	Finger-print Reader	NFC	TPM	Battery (internal+external)	Power Adapter	OS	Warranty	Ann Date (m/y)
20H9000MUS	US	i5-7200U	No	Intel HD 620	8GBx1	15.6" FHD (1920x1080) IPS	None	256GB SSD PCIe NVMe Opal2	None	Intel 8265 ac, 2x2 + BT4.1	WWAN Upgradable	None	None	None	None	720p	Backlit	Finger-print Reader	None	dTPM 2.0	4-cell(32Wh) + 3-cell(24Wh)	45W	Win10 Pro 64	3-year, Depot	01/17
20H9000NUS	US	i7-7600U	vPro	Intel HD 620	8GBx1	15.6" FHD (1920x1080) IPS	None	256GB SSD PCIe NVMe Opal2	None	Intel 8265 ac, 2x2 + BT4.1	WWAN Upgradable	None	None	None	None	720p	Backlit	Finger-print Reader	None	dTPM 2.0	4-cell(32Wh) + 3-cell(24Wh)	45W	Win10 Pro 64	3-year, Depot	01/17
20H9000PUS	US	i5-7300U	vPro	Intel HD 620	8GBx1	15.6" FHD (1920x1080) IPS	None	256GB SSD PCIe NVMe Opal2	None	Intel 8265 ac, 2x2 + BT4.1	WWAN Upgradable	None	None	None	None	720p	Backlit	Finger-print Reader	None	dTPM 2.0	4-cell(32Wh) + 3-cell(24Wh)	45W	Win10 Pro 64	3-year, Depot	01/17
20H9000QUS	US	i5-7200U	No	Intel HD 620	4GBx1	15.6" FHD (1920x1080) IPS	10-point Multi-touch	500GB 7200rpm	None	Intel 8265 ac, 2x2 + BT4.1	WWAN Upgradable	None	None	None	None	720p	Backlit	Finger-print Reader	None	dTPM 2.0	4-cell(32Wh) + 3-cell(24Wh)	45W	Win10 Pro 64	3-year, Depot	01/17
20H9000RUS	US	i5-7200U	No	Intel HD 620	8GBx1	15.6" FHD (1920x1080) IPS	10-point Multi-touch	256GB SSD PCIe NVMe Opal2	None	Intel 8265 ac, 2x2 + BT4.1	WWAN Upgradable	None	None	None	None	720p	Backlit	Finger-print Reader	None	dTPM 2.0	4-cell(32Wh) + 3-cell(24Wh)	45W	Win10 Pro 64	3-year, Depot	01/17
20H9000SUS	US	i5-7200U	No	Intel HD 620	4GBx1	15.6" FHD (1920x1080) IPS	None	500GB 7200rpm	None	Intel 8265 ac, 2x2 + BT4.1	WWAN Upgradable	None	None	None	None	720p	Backlit	Finger-print Reader	None	dTPM 2.0	4-cell(32Wh) + 3-cell(24Wh)	45W	Win10 Pro 64	1-year, Depot	01/17
20H9000TUS	US	i7-7600U	vPro	Intel HD 620	8GBx1	15.6" FHD (1920x1080) IPS	10-point Multi-touch	256GB SSD PCIe NVMe Opal2	None	Intel 8265 ac, 2x2 + BT4.1	WWAN Upgradable	None	None	None	None	720p	Backlit	Finger-print Reader	None	dTPM 2.0	4-cell(32Wh) + 3-cell(24Wh)	45W	Win10 Pro 64	3-year, Depot	01/17
20H9000UUS	US	i5-7300U	vPro	Intel HD 620	8GBx1	15.6" FHD (1920x1080) IPS	10-point Multi-touch	256GB SSD PCIe NVMe Opal2	None	Intel 8265 ac, 2x2 + BT4.1	WWAN Upgradable	None	None	None	None	720p	Backlit	Finger-print Reader	None	dTPM 2.0	4-cell(32Wh) + 3-cell(24Wh)	45W	Win10 Pro 64	3-year, Depot	01/17



ThinkPad X1 Carbon (4th Gen) Platform Specifications

Product Specifications Reference (PSREF)

Processor	6th Generation Intel® Core™ i5 / i7 Processor								Media reader Ports WiGig dock (opt) Adapter (optional)	MicroSD card reader, supports UHS-II microSD card Three USB 3.0 (one Always On), MiniDP, HDMI, Lenovo OneLink+ connector WiGig dock, mutually exclusive with WWAN HDMI-VGA: Lenovo HDMI to VGA Monitor Cable mDP-VGA: Lenovo Mini DisplayPort to VGA Monitor Cable RJ45: ThinkPad OneLink+ to RJ45 adapter VGA/RJ45: ThinkPad OneLink+ to VGA/RJ45 adapter												
	Processor Number	# of Cores	# of Threads	Base Frequency	Max Turbo Frequency	Cache	Memory Types	Processor Graphics														
	i5-6200U	2	4	2.3 GHz	2.8 GHz	3MB	LPDDR3-1866	Intel HD graphics 520														
	i5-6300U			2.4 GHz	3.0 GHz	3MB																
	i7-6500U			2.5 GHz	3.1 GHz	4MB																
i7-6600U	2.6 GHz			3.4 GHz	4MB																	
Graphics	Intel HD Graphics 520 in processor, external digital monitor support via Mini DisplayPort or HDMI™; supports three independent displays; Max resolution: 3840x2160 (Mini DisplayPort)@60Hz; 4096x2304 (HDMI)@24Hz								Camera Audio support	HD720p resolution, low light sensitive, fixed focus HD Audio, Conexant® CX11852 codec / stereo speakers, 1 watt x 2 / dual array microphone, combo audio/microphone jack												
Chipset Memory	Intel SoC (System on Chip) platform 4GB, 8GB, or 16GB / 1866MHz LPDDR3 / soldered to systemboard, no sockets								Keyboard UltraNav™	6-row, spill-resistant, multimedia Fn keys, LED backlight TrackPoint® pointing device and buttonless glass surface touchpad, multi-touch												
Display	Some: 14.0" (355mm) FHD (1920x1080), anti-glare, LED backlight, IPS, 300 nits, 16:9 aspect ratio, 700:1 contrast ratio, 170° viewing angle Some: 14.0" (355mm) WQHD (2560x1440), anti-glare, LED backlight, IPS, 300 nits, 16:9 aspect ratio, 700:1 contrast ratio, 72% gamut, 170° viewing angle								Security	Power-on password, hard disk password, supervisor password, security keyhole, reset switch												
Multi-touch Hinge	None Normal hinge, 180 degree								Security chip ThinkEngine	Discrete TPM 1.2 TCG Certified and Firmware TPM 2.0 integrated in chipset Delivers improved thermal and power efficiency, up to 30 day standby, faster resume time, enhanced security, as well as anti-tampering measures												
Storage	Some: M.2 SSD / SATA 6.0Gb/s (e.g. xxxG SSD) Some: M.2 SSD / PCIe NVMe, PCIe 3.0 x 4, 32Gb/s (e.g. xxxG SSD PCIe NVMe)								vPro (optional) Fingerprint reader	Intel vPro Technology Touch style fingerprint reader on the palm rest												
Optical	None								Battery	Integrated Lithium Polymer 4-cell (52Wh) RapidCharge battery												
Ethernet	Gigabit Ethernet via optional Ethernet (RJ-45) adapter (by native Intel Ethernet Connection I219-V (Non-vPro) or I219-LM (vPro))								Max battery life ¹⁰ AC adapter RapidCharge	MobileMark® 2014: 11 hr 45W AC adapter, 65W Slim AC adapter, or 65W AC adapter												
WLAN ⁴	One of the following, configurable by model (WiGig is mutually exclusive with WWAN): • 11ac+BT, Intel Dual Band Wireless-AC 8260, 2x2, M.2 card • WiGig™+11ac+BT, Intel Tri-Band Wireless-AC 18260, 2x2 WLAN, WiGig, M.2 card								<table border="1"> <thead> <tr> <th>AC adapter</th> <th>45W</th> <th>65W Slim</th> <th>65W</th> </tr> </thead> <tbody> <tr> <td>Charge to 80%</td> <td>Not support</td> <td>1.0 hr</td> <td>1.0 hr</td> </tr> <tr> <td>Charge to 100%</td> <td>Not support</td> <td>2.5 hr</td> <td>2.5 hr</td> </tr> </tbody> </table>		AC adapter	45W	65W Slim	65W	Charge to 80%	Not support	1.0 hr	1.0 hr	Charge to 100%	Not support	2.5 hr	2.5 hr
AC adapter	45W	65W Slim	65W																			
Charge to 80%	Not support	1.0 hr	1.0 hr																			
Charge to 100%	Not support	2.5 hr	2.5 hr																			
Bluetooth™	Bluetooth 4.1 wireless, integrated in Wi-Fi + Bluetooth combo adapter								Preload													
WWAN (optional)	One of the following, configurable by model (mutually exclusive with WiGig): • Wireless WAN upgradable • Wireless WAN, Sierra Wireless EM7455, Qualcomm® 4G LTE-Advanced/DC-HSPA+/HSPA+/HSPA/UMTS/GNSS, M.2 card • Wireless WAN, HUAWEI ME906S, HUAWEI 4G LTE/WCDMA/HSPA/GSM/GPRS/EDGE/GNSS, M.2 card (WE only)								Windows 7 Professional 64 preinstalled through downgrade rights in Windows 10 Pro 64 Windows 10 Pro 64 • Lenovo Solution Center • Lenovo Companion • Lenovo Setting • Microsoft Office preloaded; purchase a product key to activate • McAfee® LiveSafe™ (30-day trial)													
SIM card (opt)	Micro-SIM card slot, optional Verizon LTE (US) or Lenovo Connect (WE) SIM card								Limited warranty ¹² One of the following, configurable by model: • 1-year depot repair service • 3-year/1-yr battery depot repair service • 3-year/1-yr battery limited onsite service ²⁴ • 3-year/1-yr battery limited onsite service, OID (Onsite International Delivery)													
Dimensions ³ Weight ² Case material	WxDxH: 13.11" x 9.02" x 0.59-0.65"; 333.0mm x 229.0mm x 14.95-16.45mm from 2.579 lb / 1.17 kg Display cover: Carbon-Fiber Reinforced Plastic; Bottom: Super magnesium								MIL-Spec test													
									Environment	EEPEAT™ Gold (US only); ENERGY STAR® 6.1; GREENGUARD®; RoHS-compliant												

Model	Region	Processor	vPro	Graphics	Memory (Soldered)	Display	Multi-touch	Storage(HDD/SSD)	Optical	WLAN + Bluetooth	WWAN	SIM Card	Adapter	Dock	Camera	Keyboard	Fingerprint Reader	Battery (internal)	Power Adapter	Operating System	Warranty	Ann Date (m/y)
20FB002JUS	US	i5-6300U	vPro	Intel HD 520	8GB Soldered	14" FHD (1920x1080) IPS	None	256GB SSD M.2 PCIe NVMe Opal2	None	Intel 8260 ac, 2x2 + BT4.1	WWAN Upgradable	None	None	None	720p	Backlit	Fingerprint Reader	4-cell (52Wh)	65W	Win10 DG Win7 Pro 64	3-year, Depot	02/16
20FB002KUS	US	i5-6200U	No	Intel HD 520	8GB Soldered	14" FHD (1920x1080) IPS	None	256GB SSD M.2 PCIe NVMe Opal2	None	Intel 8260 ac, 2x2 + BT4.1	WWAN Upgradable	None	None	None	720p	Backlit	Fingerprint Reader	4-cell (52Wh)	65W	Win10 DG Win7 Pro 64	3-year, Depot	02/16
20FB002LUS	US	i7-6600U	vPro	Intel HD 520	16GB Soldered	14" WQHD (2560x1440) IPS	None	512GB SSD M.2	None	Intel 8260 ac, 2x2 + BT4.1	WWAN Upgradable	None	None	None	720p	Backlit	Fingerprint Reader	4-cell (52Wh)	65W	Win10 DG Win7 Pro 64	3-year, Depot	02/16
20FB002MUS	US	i5-6200U	No	Intel HD 520	8GB Soldered	14" FHD (1920x1080) IPS	None	128GB SSD M.2	None	Intel 8260 ac, 2x2 + BT4.1	WWAN Upgradable	None	None	None	720p	Backlit	Fingerprint Reader	4-cell (52Wh)	65W	Win10 DG Win7 Pro 64	3-year, Depot	02/16
20FB002NUS	US	i7-6600U	vPro	Intel HD 520	16GB Soldered	14" WQHD (2560x1440) IPS	None	256GB SSD M.2 PCIe NVMe Opal2	None	Intel 8260 ac, 2x2 + BT4.1	WWAN Upgradable	None	None	None	720p	Backlit	Fingerprint Reader	4-cell (52Wh)	65W	Win10 DG Win7 Pro 64	3-year, Depot	02/16
20FB002PUS	US	i5-6200U	No	Intel HD 520	8GB Soldered	14" FHD (1920x1080) IPS	None	512GB SSD M.2	None	Intel 8260 ac, 2x2 + BT4.1	WWAN Upgradable	None	None	None	720p	Backlit	Fingerprint Reader	4-cell (52Wh)	65W	Win10 DG Win7 Pro 64	3-year, Depot	02/16
20FB002QUS	US	i7-6600U	vPro	Intel HD 520	8GB Soldered	14" WQHD (2560x1440) IPS	None	256GB SSD M.2 Opal2	None	Intel 8260 ac, 2x2 + BT4.1	WWAN Upgradable	None	None	None	720p	Backlit	Fingerprint Reader	4-cell (52Wh)	65W	Win10 DG Win7 Pro 64	3-year, Depot	02/16
20FB002RUS	US	i5-6200U	No	Intel HD 520	8GB Soldered	14" FHD (1920x1080) IPS	None	256GB SSD M.2 Opal2	None	Intel 8260 ac, 2x2 + BT4.1	WWAN Upgradable	None	None	None	720p	Backlit	Fingerprint Reader	4-cell (52Wh)	65W	Win10 DG Win7 Pro 64	3-year, Depot	02/16
20FB002SUS	US	i7-6600U	vPro	Intel HD 520	8GB Soldered	14" WQHD (2560x1440) IPS	None	512GB SSD M.2	None	Intel 8260 ac, 2x2 + BT4.1	WWAN Upgradable	None	None	None	720p	Backlit	Fingerprint Reader	4-cell (52Wh)	65W	Win10 DG Win7 Pro 64	3-year, Depot	02/16
20FB0044US	US	i7-6600U	vPro	Intel HD 520	16GB Soldered	14" WQHD (2560x1440) IPS	None	180GB SSD M.2 Opal2	None	Intel 8260 ac, 2x2 + BT4.1	None	None	None	None	720p	Backlit	Fingerprint Reader	4-cell (52Wh)	65W	Win10 Pro 64	3-year, Depot	02/16
20FB0045US	US	i7-6600U	vPro	Intel HD 520	16GB Soldered	14" FHD (1920x1080) IPS	None	256GB SSD M.2 Opal2	None	Intel 8260 ac, 2x2 + BT4.1	WWAN Upgradable	None	None	None	720p	Backlit	Fingerprint Reader	4-cell (52Wh)	65W	Win10 DG Win7 Pro 64	3-year, Depot	02/16
20FB0046US	US	i7-6600U	vPro	Intel HD 520	8GB Soldered	14" FHD (1920x1080) IPS	None	256GB SSD M.2 Opal2	None	Intel 8260 ac, 2x2 + BT4.1	WWAN Upgradable	None	None	None	720p	Backlit	Fingerprint Reader	4-cell (52Wh)	65W	Win10 Pro 64	3-year, Depot	02/16
20FB0047US	US	i5-6300U	vPro	Intel HD 520	8GB Soldered	14" FHD (1920x1080) IPS	None	128GB SSD M.2	None	Intel 8260 ac, 2x2 + BT4.1	WWAN Upgradable	None	None	None	720p	Backlit	Fingerprint Reader	4-cell (52Wh)	65W	Win10 Pro 64	3-year, Depot	02/16
20FB0048US	US	i7-6600U	vPro	Intel HD 520	16GB Soldered	14" FHD (1920x1080) IPS	None	512GB SSD M.2	None	Intel 8260 ac, 2x2 + BT4.1	WWAN Upgradable	None	None	None	720p	Backlit	Fingerprint Reader	4-cell (52Wh)	65W	Win10 DG Win7 Pro 64	3-year, Depot	02/16
20FB0049US	US	i7-6600U	vPro	Intel HD 520	16GB Soldered	14" WQHD (2560x1440) IPS	None	256GB SSD M.2 Opal2	None	Intel 8260 ac, 2x2 + BT4.1	WWAN Upgradable	None	None	None	720p	Backlit	Fingerprint Reader	4-cell (52Wh)	65W	Win10 Pro 64	3-year, Depot	02/16
20FB004AUS	US	i5-6300U	vPro	Intel HD 520	8GB Soldered	14" FHD (1920x1080) IPS	None	128GB SSD M.2	None	Intel 8260 ac, 2x2 + BT4.1	WWAN Upgradable	None	None	None	720p	Backlit	Fingerprint Reader	4-cell (52Wh)	65W	Win10 DG Win7 Pro 64	3-year, Depot	02/16
20FB004BUS	US	i5-6300U	vPro	Intel HD 520	8GB Soldered	14" FHD (1920x1080) IPS	None	180GB SSD M.2 Opal2	None	Intel 8260 ac, 2x2 + BT4.1	WWAN Upgradable	None	None	None	720p	Backlit	Fingerprint Reader	4-cell (52Wh)	65W	Win10 DG Win7 Pro 64	3-year, Depot	02/16
20FB004CUS	US	i5-6300U	vPro	Intel HD 520	8GB Soldered	14" WQHD (2560x1440) IPS	None	256GB SSD M.2 PCIe NVMe Opal2	None	Intel 8260 ac, 2x2 + BT4.1	WWAN Upgradable	None	None	None	720p	Backlit	Fingerprint Reader	4-cell (52Wh)	65W	Win10 Pro 64	3-year, Depot	02/16
20FB004DUS	US	i7-6600U	vPro	Intel HD 520	8GB Soldered	14" FHD (1920x1080) IPS	None	192GB SSD M.2	None	Intel 8260 ac, 2x2 + BT4.1	WWAN Upgradable	None	None	None	720p	Backlit	Fingerprint Reader	4-cell (52Wh)	65W	Win10 Pro 64	3-year, Depot	02/16
20FB004EUS	US	i7-6600U	vPro	Intel HD 520	8GB Soldered	14" FHD (1920x1080) IPS	None	512GB SSD M.2	None	Intel 8260 ac, 2x2 + BT4.1	WWAN Upgradable	None	None	None	720p	Backlit	Fingerprint Reader	4-cell (52Wh)	65W	Win10 DG Win7 Pro 64	3-year, Depot	02/16

Model	Region	Processor	vPro	Graphics	Memory (Soldered)	Display	Multi-touch	Storage(HDD/SSD)	Optical	WLAN + Bluetooth	WWAN	SIM Card	Adapter	Dock	Camera	Keyboard	Fingerprint Reader	Battery (internal)	Power Adapter	Operating System	Warranty	Ann Date (m/y)
20FB004FUS	US	i5-6300U	vPro	Intel HD 520	8GB Soldered	14" WQHD (2560x1440) IPS	None	128GB SSD M.2	None	Intel 8260 ac, 2x2 + BT4.1	None	None	None	None	720p	Backlit	Fingerprint Reader	4-cell (52Wh)	65W	Win10 Pro 64	3-year, Depot	02/16
20FB004GUS	US	i5-6300U	vPro	Intel HD 520	8GB Soldered	14" WQHD (2560x1440) IPS	None	256GB SSD M.2 Opal2	None	Intel 8260 ac, 2x2 + BT4.1	None	None	None	None	720p	Backlit	Fingerprint Reader	4-cell (52Wh)	65W	Win10 Pro 64	3-year, Depot	02/16
20FB004HUS	US	i7-6600U	vPro	Intel HD 520	16GB Soldered	14" WQHD (2560x1440) IPS	None	240GB SSD M.2 Opal2	None	Intel 8260 ac, 2x2 + BT4.1	None	None	None	None	720p	Backlit	Fingerprint Reader	4-cell (52Wh)	65W	Win10 Pro 64	3-year, Depot	02/16
20FB004JUS	US	i5-6300U	vPro	Intel HD 520	8GB Soldered	14" FHD (1920x1080) IPS	None	256GB SSD M.2 Opal2	None	Intel 8260 ac, 2x2 + BT4.1	WWAN Upgradable	None	None	None	720p	Backlit	Fingerprint Reader	4-cell (52Wh)	65W	Win10 DG Win7 Pro 64	3-year, Depot	02/16
20FB004KUS	US	i7-6600U	vPro	Intel HD 520	8GB Soldered	14" WQHD (2560x1440) IPS	None	512GB SSD M.2 PCIe NVMe	None	Intel 8260 ac, 2x2 + BT4.1	None	None	None	None	720p	Backlit	Fingerprint Reader	4-cell (52Wh)	65W	Win10 Pro 64	3-year, Depot	02/16
20FB004LUS	US	i5-6200U	No	Intel HD 520	8GB Soldered	14" FHD (1920x1080) IPS	None	180GB SSD M.2 Opal2	None	Intel 8260 ac, 2x2 + BT4.1	WWAN Upgradable	None	None	None	720p	Backlit	Fingerprint Reader	4-cell (52Wh)	65W	Win10 DG Win7 Pro 64	3-year, Depot	02/16
20FB004MUS	US	i7-6600U	vPro	Intel HD 520	8GB Soldered	14" FHD (1920x1080) IPS	None	512GB SSD M.2 PCIe NVMe	None	Intel 8260 ac, 2x2 + BT4.1	WWAN Upgradable	None	None	None	720p	Backlit	Fingerprint Reader	4-cell (52Wh)	65W	Win10 DG Win7 Pro 64	3-year, Depot	02/16
20FB004NUS	US	i7-6600U	vPro	Intel HD 520	16GB Soldered	14" WQHD (2560x1440) IPS	None	512GB SSD M.2	None	Intel 8260 ac, 2x2 + BT4.1	WWAN Upgradable	None	None	None	720p	Backlit	Fingerprint Reader	4-cell (52Wh)	65W	Win10 Pro 64	3-year, Depot	02/16
20FB004PUS	US	i5-6300U	vPro	Intel HD 520	8GB Soldered	14" FHD (1920x1080) IPS	None	192GB SSD M.2	None	Intel 8260 ac, 2x2 + BT4.1	WWAN Upgradable	None	None	None	720p	Backlit	Fingerprint Reader	4-cell (52Wh)	65W	Win10 Pro 64	3-year, Depot	02/16
20FB004QUS	US	i7-6600U	vPro	Intel HD 520	16GB Soldered	14" FHD (1920x1080) IPS	None	512GB SSD M.2 PCIe NVMe	None	Intel 8260 ac, 2x2 + BT4.1	WWAN Upgradable	None	None	None	720p	Backlit	Fingerprint Reader	4-cell (52Wh)	65W	Win10 Pro 64	3-year, Depot	02/16
20FB004RUS	US	i7-6600U	vPro	Intel HD 520	16GB Soldered	14" FHD (1920x1080) IPS	None	256GB SSD M.2 PCIe NVMe Opal2	None	Intel 8260 ac, 2x2 + BT4.1	WWAN Upgradable	None	None	None	720p	Backlit	Fingerprint Reader	4-cell (52Wh)	65W	Win10 Pro 64	3-year, Depot	02/16
20FB004SUS	US	i5-6300U	vPro	Intel HD 520	8GB Soldered	14" WQHD (2560x1440) IPS	None	180GB SSD M.2 Opal2	None	Intel 8260 ac, 2x2 + BT4.1	None	None	None	None	720p	Backlit	Fingerprint Reader	4-cell (52Wh)	65W	Win10 Pro 64	3-year, Depot	02/16
20FB004TUS	US	i5-6300U	vPro	Intel HD 520	8GB Soldered	14" FHD (1920x1080) IPS	None	192GB SSD M.2	None	Intel 8260 ac, 2x2 + BT4.1	WWAN Upgradable	None	None	None	720p	Backlit	Fingerprint Reader	4-cell (52Wh)	65W	Win10 DG Win7 Pro 64	3-year, Depot	02/16
20FB004UUS	US	i7-6600U	vPro	Intel HD 520	8GB Soldered	14" FHD (1920x1080) IPS	None	512GB SSD M.2 PCIe NVMe	None	Intel 8260 ac, 2x2 + BT4.1	WWAN Upgradable	None	None	None	720p	Backlit	Fingerprint Reader	4-cell (52Wh)	65W	Win10 Pro 64	3-year, Depot	02/16
20FB004VUS	US	i5-6300U	vPro	Intel HD 520	8GB Soldered	14" WQHD (2560x1440) IPS	None	256GB SSD M.2 Opal2	None	Intel 8260 ac, 2x2 + BT4.1	WWAN Upgradable	None	None	None	720p	Backlit	Fingerprint Reader	4-cell (52Wh)	65W	Win10 Pro 64	3-year, Depot	02/16
20FB004WUS	US	i5-6300U	vPro	Intel HD 520	8GB Soldered	14" FHD (1920x1080) IPS	None	180GB SSD M.2 Opal2	None	Intel 8260 ac, 2x2 + BT4.1	WWAN Upgradable	None	None	None	720p	Backlit	Fingerprint Reader	4-cell (52Wh)	65W	Win10 Pro 64	3-year, Depot	02/16
20FB004XUS	US	i7-6600U	vPro	Intel HD 520	16GB Soldered	14" FHD (1920x1080) IPS	None	240GB SSD M.2 Opal2	None	Intel 8260 ac, 2x2 + BT4.1	WWAN Upgradable	None	None	None	720p	Backlit	Fingerprint Reader	4-cell (52Wh)	65W	Win10 Pro 64	3-year, Depot	02/16
20FB004YUS	US	i7-6600U	vPro	Intel HD 520	16GB Soldered	14" FHD (1920x1080) IPS	None	512GB SSD M.2	None	Intel 8260 ac, 2x2 + BT4.1	WWAN Upgradable	None	None	None	720p	Backlit	Fingerprint Reader	4-cell (52Wh)	65W	Win10 Pro 64	3-year, Depot	02/16
20FB0050US	US	i5-6300U	vPro	Intel HD 520	8GB Soldered	14" FHD (1920x1080) IPS	None	512GB SSD M.2	None	Intel 8260 ac, 2x2 + BT4.1	WWAN Upgradable	None	None	None	720p	Backlit	Fingerprint Reader	4-cell (52Wh)	65W	Win10 DG Win7 Pro 64	3-year, Depot	02/16
20FB0051US	US	i7-6600U	vPro	Intel HD 520	16GB Soldered	14" FHD (1920x1080) IPS	None	256GB SSD M.2 Opal2	None	Intel 8260 ac, 2x2 + BT4.1	WWAN Upgradable	None	None	None	720p	Backlit	Fingerprint Reader	4-cell (52Wh)	65W	Win10 Pro 64	3-year, Depot	02/16

Model	Region	Processor	vPro	Graphics	Memory (Soldered)	Display	Multi-touch	Storage(HDD/SSD)	Optical	WLAN + Bluetooth	WWAN	SIM Card	Adapter	Dock	Camera	Keyboard	Fingerprint Reader	Battery (internal)	Power Adapter	Operating System	Warranty	Ann Date (m/y)
20FB0052US	US	i7-6600U	vPro	Intel HD 520	16GB Soldered	14" WQHD (2560x1440) IPS	None	256GB SSD M.2 PCIe NVMe Opal2	None	Intel 8260 ac, 2x2 + BT4.1	WWAN Upgradable	None	None	None	720p	Backlit	Fingerprint Reader	4-cell (52Wh)	65W	Win10 Pro 64	3-year, Depot	02/16
20FB0053US	US	i5-6300U	vPro	Intel HD 520	8GB Soldered	14" WQHD (2560x1440) IPS	None	512GB SSD M.2 PCIe NVMe	None	Intel 8260 ac, 2x2 + BT4.1	None	None	None	None	720p	Backlit	Fingerprint Reader	4-cell (52Wh)	65W	Win10 Pro 64	3-year, Depot	02/16
20FB0054US	US	i7-6600U	vPro	Intel HD 520	16GB Soldered	14" WQHD (2560x1440) IPS	None	256GB SSD M.2 PCIe NVMe Opal2	None	Intel 8260 ac, 2x2 + BT4.1	None	None	None	None	720p	Backlit	Fingerprint Reader	4-cell (52Wh)	65W	Win10 Pro 64	3-year, Depot	02/16
20FB0055US	US	i5-6300U	vPro	Intel HD 520	8GB Soldered	14" WQHD (2560x1440) IPS	None	512GB SSD M.2	None	Intel 8260 ac, 2x2 + BT4.1	None	None	None	None	720p	Backlit	Fingerprint Reader	4-cell (52Wh)	65W	Win10 Pro 64	3-year, Depot	02/16
20FB0056US	US	i7-6500U	No	Intel HD 520	8GB Soldered	14" FHD (1920x1080) IPS	None	256GB SSD M.2 Opal2	None	Intel 8260 ac, 2x2 + BT4.1	WWAN Upgradable	None	None	None	720p	Backlit	Fingerprint Reader	4-cell (52Wh)	65W	Win10 Pro 64	3-year, Depot	02/16
20FB0057US	US	i7-6600U	vPro	Intel HD 520	8GB Soldered	14" FHD (1920x1080) IPS	None	256GB SSD M.2 PCIe NVMe Opal2	None	Intel 8260 ac, 2x2 + BT4.1	WWAN Upgradable	None	None	None	720p	Backlit	Fingerprint Reader	4-cell (52Wh)	65W	Win10 Pro 64	3-year, Depot	02/16
20FB0058US	US	i7-6600U	vPro	Intel HD 520	16GB Soldered	14" WQHD (2560x1440) IPS	None	240GB SSD M.2 Opal2	None	Intel 8260 ac, 2x2 + BT4.1	WWAN Upgradable	None	None	None	720p	Backlit	Fingerprint Reader	4-cell (52Wh)	65W	Win10 Pro 64	3-year, Depot	02/16
20FB0059US	US	i5-6300U	vPro	Intel HD 520	8GB Soldered	14" FHD (1920x1080) IPS	None	256GB SSD M.2 Opal2	None	Intel 8260 ac, 2x2 + BT4.1	WWAN Upgradable	None	None	None	720p	Backlit	Fingerprint Reader	4-cell (52Wh)	65W	Win10 Pro 64	3-year, Depot	02/16
20FB005AUS	US	i7-6600U	vPro	Intel HD 520	8GB Soldered	14" FHD (1920x1080) IPS	None	192GB SSD M.2	None	Intel 8260 ac, 2x2 + BT4.1	WWAN Upgradable	None	None	None	720p	Backlit	Fingerprint Reader	4-cell (52Wh)	65W	Win10 DG Win7 Pro 64	3-year, Depot	02/16
20FB005BUS	US	i7-6600U	vPro	Intel HD 520	16GB Soldered	14" WQHD (2560x1440) IPS	None	192GB SSD M.2	None	Intel 8260 ac, 2x2 + BT4.1	None	None	None	None	720p	Backlit	Fingerprint Reader	4-cell (52Wh)	65W	Win10 Pro 64	3-year, Depot	02/16
20FB005CUS	US	i7-6600U	vPro	Intel HD 520	8GB Soldered	14" FHD (1920x1080) IPS	None	128GB SSD M.2	None	Intel 8260 ac, 2x2 + BT4.1	WWAN Upgradable	None	None	None	720p	Backlit	Fingerprint Reader	4-cell (52Wh)	65W	Win10 DG Win7 Pro 64	3-year, Depot	02/16
20FB005DUS	US	i7-6500U	No	Intel HD 520	8GB Soldered	14" FHD (1920x1080) IPS	None	256GB SSD M.2 PCIe NVMe Opal2	None	Intel 8260 ac, 2x2 + BT4.1	WWAN Upgradable	None	None	None	720p	Backlit	Fingerprint Reader	4-cell (52Wh)	65W	Win10 Pro 64	3-year, Depot	02/16
20FB005EUS	US	i5-6300U	vPro	Intel HD 520	8GB Soldered	14" FHD (1920x1080) IPS	None	240GB SSD M.2 Opal2	None	Intel 8260 ac, 2x2 + BT4.1	WWAN Upgradable	None	None	None	720p	Backlit	Fingerprint Reader	4-cell (52Wh)	65W	Win10 Pro 64	3-year, Depot	02/16
20FB005FUS	US	i7-6500U	No	Intel HD 520	8GB Soldered	14" FHD (1920x1080) IPS	None	192GB SSD M.2	None	Intel 8260 ac, 2x2 + BT4.1	WWAN Upgradable	None	None	None	720p	Backlit	Fingerprint Reader	4-cell (52Wh)	65W	Win10 Pro 64	3-year, Depot	02/16
20FB005GUS	US	i7-6600U	vPro	Intel HD 520	16GB Soldered	14" WQHD (2560x1440) IPS	None	256GB SSD M.2 Opal2	None	Intel 8260 ac, 2x2 + BT4.1	None	None	None	None	720p	Backlit	Fingerprint Reader	4-cell (52Wh)	65W	Win10 Pro 64	3-year, Depot	02/16
20FB005HUS	US	i5-6300U	vPro	Intel HD 520	8GB Soldered	14" WQHD (2560x1440) IPS	None	128GB SSD M.2	None	Intel 8260 ac, 2x2 + BT4.1	WWAN Upgradable	None	None	None	720p	Backlit	Fingerprint Reader	4-cell (52Wh)	65W	Win10 Pro 64	3-year, Depot	02/16
20FB005JUS	US	i5-6300U	vPro	Intel HD 520	8GB Soldered	14" WQHD (2560x1440) IPS	None	512GB SSD M.2	None	Intel 8260 ac, 2x2 + BT4.1	WWAN Upgradable	None	None	None	720p	Backlit	Fingerprint Reader	4-cell (52Wh)	65W	Win10 Pro 64	3-year, Depot	02/16
20FB005KUS	US	i7-6600U	vPro	Intel HD 520	8GB Soldered	14" FHD (1920x1080) IPS	None	256GB SSD M.2 PCIe NVMe Opal2	None	Intel 8260 ac, 2x2 + BT4.1	WWAN Upgradable	None	None	None	720p	Backlit	Fingerprint Reader	4-cell (52Wh)	65W	Win10 DG Win7 Pro 64	3-year, Depot	02/16
20FB005LUS	US	i7-6600U	vPro	Intel HD 520	16GB Soldered	14" WQHD (2560x1440) IPS	None	512GB SSD M.2 PCIe NVMe	None	Intel 8260 ac, 2x2 + BT4.1	WWAN Upgradable	None	None	None	720p	Backlit	Fingerprint Reader	4-cell (52Wh)	65W	Win10 Pro 64	3-year, Depot	02/16
20FB005MUS	US	i5-6300U	vPro	Intel HD 520	8GB Soldered	14" FHD (1920x1080) IPS	None	512GB SSD M.2	None	Intel 8260 ac, 2x2 + BT4.1	WWAN Upgradable	None	None	None	720p	Backlit	Fingerprint Reader	4-cell (52Wh)	65W	Win10 Pro 64	3-year, Depot	02/16

Model	Region	Processor	vPro	Graphics	Memory (Soldered)	Display	Multi-touch	Storage(HDD/SSD)	Optical	WLAN + Bluetooth	WWAN	SIM Card	Adapter	Dock	Camera	Keyboard	Fingerprint Reader	Battery (internal)	Power Adapter	Operating System	Warranty	Ann Date (m/y)
20FB005NUS	US	i7-6600U	vPro	Intel HD 520	16GB Soldered	14" WQHD (2560x1440) IPS	None	512GB SSD M.2 PCIe NVMe	None	Intel 8260 ac, 2x2 + BT4.1	None	None	None	None	720p	Backlit	Fingerprint Reader	4-cell (52Wh)	65W	Win10 Pro 64	3-year, Depot	02/16
20FB005PUS	US	i7-6600U	vPro	Intel HD 520	16GB Soldered	14" FHD (1920x1080) IPS	None	256GB SSD M.2 PCIe NVMe Opal2	None	Intel 8260 ac, 2x2 + BT4.1	WWAN Upgradable	None	None	None	720p	Backlit	Fingerprint Reader	4-cell (52Wh)	65W	Win10 DG Win7 Pro 64	3-year, Depot	02/16
20FB005QUS	US	i5-6300U	vPro	Intel HD 520	8GB Soldered	14" WQHD (2560x1440) IPS	None	256GB SSD M.2 PCIe NVMe Opal2	None	Intel 8260 ac, 2x2 + BT4.1	None	None	None	None	720p	Backlit	Fingerprint Reader	4-cell (52Wh)	65W	Win10 Pro 64	3-year, Depot	02/16
20FB005RUS	US	i7-6600U	vPro	Intel HD 520	8GB Soldered	14" WQHD (2560x1440) IPS	None	512GB SSD M.2	None	Intel 8260 ac, 2x2 + BT4.1	None	None	None	None	720p	Backlit	Fingerprint Reader	4-cell (52Wh)	65W	Win10 Pro 64	3-year, Depot	02/16
20FB005SUS	US	i7-6600U	vPro	Intel HD 520	16GB Soldered	14" FHD (1920x1080) IPS	None	512GB SSD M.2 PCIe NVMe	None	Intel 8260 ac, 2x2 + BT4.1	WWAN Upgradable	None	None	None	720p	Backlit	Fingerprint Reader	4-cell (52Wh)	65W	Win10 DG Win7 Pro 64	3-year, Depot	02/16
20FB005TUS	US	i5-6200U	No	Intel HD 520	8GB Soldered	14" FHD (1920x1080) IPS	None	128GB SSD M.2	None	Intel 8260 ac, 2x2 + BT4.1	WWAN Upgradable	None	None	None	720p	Backlit	Fingerprint Reader	4-cell (52Wh)	65W	Win10 Pro 64	3-year, Depot	02/16
20FB005UUS	US	i7-6500U	No	Intel HD 520	8GB Soldered	14" FHD (1920x1080) IPS	None	512GB SSD M.2	None	Intel 8260 ac, 2x2 + BT4.1	WWAN Upgradable	None	None	None	720p	Backlit	Fingerprint Reader	4-cell (52Wh)	65W	Win10 Pro 64	3-year, Depot	02/16
20FB005VUS	US	i7-6600U	vPro	Intel HD 520	16GB Soldered	14" WQHD (2560x1440) IPS	None	512GB SSD M.2	None	Intel 8260 ac, 2x2 + BT4.1	None	None	None	None	720p	Backlit	Fingerprint Reader	4-cell (52Wh)	65W	Win10 Pro 64	3-year, Depot	02/16
20FB005WUS	US	i7-6600U	vPro	Intel HD 520	8GB Soldered	14" FHD (1920x1080) IPS	None	256GB SSD M.2 Opal2	None	Intel 8260 ac, 2x2 + BT4.1	WWAN Upgradable	None	None	None	720p	Backlit	Fingerprint Reader	4-cell (52Wh)	65W	Win10 DG Win7 Pro 64	3-year, Depot	02/16
20FB005XUS	US	i5-6300U	vPro	Intel HD 520	8GB Soldered	14" FHD (1920x1080) IPS	None	256GB SSD M.2 PCIe NVMe Opal2	None	Intel 8260 ac, 2x2 + BT4.1	WWAN Upgradable	None	None	None	720p	Backlit	Fingerprint Reader	4-cell (52Wh)	65W	Win10 Pro 64	3-year, Depot	02/16
20FB005YUS	US	i7-6500U	No	Intel HD 520	8GB Soldered	14" FHD (1920x1080) IPS	None	512GB SSD M.2 PCIe NVMe	None	Intel 8260 ac, 2x2 + BT4.1	WWAN Upgradable	None	None	None	720p	Backlit	Fingerprint Reader	4-cell (52Wh)	65W	Win10 Pro 64	3-year, Depot	02/16
20FB0060US	US	i7-6600U	vPro	Intel HD 520	8GB Soldered	14" FHD (1920x1080) IPS	None	128GB SSD M.2	None	Intel 8260 ac, 2x2 + BT4.1	WWAN Upgradable	None	None	None	720p	Backlit	Fingerprint Reader	4-cell (52Wh)	65W	Win10 Pro 64	3-year, Depot	02/16
20FB0061US	US	i5-6300U	vPro	Intel HD 520	8GB Soldered	14" WQHD (2560x1440) IPS	None	192GB SSD M.2	None	Intel 8260 ac, 2x2 + BT4.1	None	None	None	None	720p	Backlit	Fingerprint Reader	4-cell (52Wh)	65W	Win10 Pro 64	3-year, Depot	02/16
20FB0062US	US	i7-6600U	vPro	Intel HD 520	8GB Soldered	14" FHD (1920x1080) IPS	None	512GB SSD M.2	None	Intel 8260 ac, 2x2 + BT4.1	WWAN Upgradable	None	None	None	720p	Backlit	Fingerprint Reader	4-cell (52Wh)	65W	Win10 Pro 64	3-year, Depot	02/16
20FB0063US	US	i7-6600U	vPro	Intel HD 520	8GB Soldered	14" WQHD (2560x1440) IPS	None	256GB SSD M.2 PCIe NVMe Opal2	None	Intel 8260 ac, 2x2 + BT4.1	None	None	None	None	720p	Backlit	Fingerprint Reader	4-cell (52Wh)	65W	Win10 Pro 64	3-year, Depot	02/16
20FB0064US	US	i7-6600U	vPro	Intel HD 520	8GB Soldered	14" WQHD (2560x1440) IPS	None	256GB SSD M.2 Opal2	None	Intel 8260 ac, 2x2 + BT4.1	None	None	None	None	720p	Backlit	Fingerprint Reader	4-cell (52Wh)	65W	Win10 Pro 64	3-year, Depot	02/16
20FB0065US	US	i7-6600U	vPro	Intel HD 520	16GB Soldered	14" FHD (1920x1080) IPS	None	128GB SSD M.2	None	Intel 8260 ac, 2x2 + BT4.1	WWAN Upgradable	None	None	None	720p	Backlit	Fingerprint Reader	4-cell (52Wh)	65W	Win10 DG Win7 Pro 64	3-year, Depot	02/16
20FB006RUS	US	i7-6600U	vPro	Intel HD 520	8GB Soldered	14" WQHD (2560x1440) IPS	None	256GB SSD M.2 Opal2	None	Intel 8260 ac, 2x2 + BT4.1	Sierra EM7455	None	None	None	720p	Backlit	Fingerprint Reader	4-cell (52Wh)	65W	Win10 Pro 64	3-year, Depot	05/16
20FB006SUS	US	i7-6500U	No	Intel HD 520	8GB Soldered	14" FHD (1920x1080) IPS	None	256GB SSD M.2 Opal2	None	Intel 8260 ac, 2x2 + BT4.1	Sierra EM7455	None	None	None	720p	Backlit	Fingerprint Reader	4-cell (52Wh)	65W	Win10 Pro 64	3-year, Depot	05/16
20FB006TUS	US	i7-6500U	No	Intel HD 520	8GB Soldered	14" WQHD (2560x1440) IPS	None	256GB SSD M.2 PCIe NVMe Opal2	None	Intel 8260 ac, 2x2 + BT4.1	Sierra EM7455	None	None	None	720p	Backlit	Fingerprint Reader	4-cell (52Wh)	65W	Win10 Pro 64	3-year, Depot	05/16

Model	Region	Processor	vPro	Graphics	Memory (Soldered)	Display	Multi-touch	Storage(HDD/SSD)	Optical	WLAN + Bluetooth	WWAN	SIM Card	Adapter	Dock	Camera	Keyboard	Fingerprint Reader	Battery (internal)	Power Adapter	Operating System	Warranty	Ann Date (m/y)
20FB006UUS	US	i7-6600U	vPro	Intel HD 520	16GB Soldered	14" WQHD (2560x1440) IPS	None	512GB SSD M.2 PCIe NVMe	None	Intel 8260 ac, 2x2 + BT4.1	Sierra EM7455	None	None	None	720p	Backlit	Fingerprint Reader	4-cell (52Wh)	65W	Win10 Pro 64	3-year, Depot	05/16
20FB006VUS	US	i5-6300U	vPro	Intel HD 520	8GB Soldered	14" WQHD (2560x1440) IPS	None	256GB SSD M.2 Opal2	None	Intel 8260 ac, 2x2 + BT4.1	Sierra EM7455	None	None	None	720p	Backlit	Fingerprint Reader	4-cell (52Wh)	65W	Win10 Pro 64	3-year, Depot	05/16
20FB006WUS	US	i5-6200U	No	Intel HD 520	8GB Soldered	14" FHD (1920x1080) IPS	None	256GB SSD M.2 Opal2	None	Intel 8260 ac, 2x2 + BT4.1	Sierra EM7455	None	None	None	720p	Backlit	Fingerprint Reader	4-cell (52Wh)	65W	Win10 Pro 64	3-year, Depot	05/16
20FB006XUS	US	i7-6600U	vPro	Intel HD 520	16GB Soldered	14" WQHD (2560x1440) IPS	None	512GB SSD M.2	None	Intel 8260 ac, 2x2 + BT4.1	Sierra EM7455	None	None	None	720p	Backlit	Fingerprint Reader	4-cell (52Wh)	65W	Win10 Pro 64	3-year, Depot	05/16
20FB0071US	US	i7-6600U	vPro	Intel HD 520	8GB Soldered	14" WQHD (2560x1440) IPS	None	256GB SSD M.2 Opal2	None	Intel 18260 ac, 2x2 + BT4.1	None	None	None	WiGig Dock	720p	Backlit	Fingerprint Reader	4-cell (52Wh)	65W	Win10 Pro 64	3-year, Depot	07/16
20FB007DUS	US	i5-6300U	vPro	Intel HD 520	8GB Soldered	14" WQHD (2560x1440) IPS	None	256GB SSD M.2 Opal2	None	Intel 18260 ac, 2x2 + BT4.1	None	None	None	WiGig Dock	720p	Backlit	Fingerprint Reader	4-cell (52Wh)	65W	Win10 DG Win7 Pro 64	3-year, Depot	07/16
20FB007EUS	US	i7-6600U	vPro	Intel HD 520	16GB Soldered	14" WQHD (2560x1440) IPS	None	512GB SSD M.2	None	Intel 18260 ac, 2x2 + BT4.1	None	None	None	WiGig Dock	720p	Backlit	Fingerprint Reader	4-cell (52Wh)	65W	Win10 DG Win7 Pro 64	3-year, Depot	07/16
20FB007FUS	US	i7-6600U	vPro	Intel HD 520	8GB Soldered	14" WQHD (2560x1440) IPS	None	256GB SSD M.2 Opal2	None	Intel 18260 ac, 2x2 + BT4.1	None	None	None	WiGig Dock	720p	Backlit	Fingerprint Reader	4-cell (52Wh)	65W	Win10 DG Win7 Pro 64	3-year, Depot	07/16
20FB007GUS	US	i7-6600U	vPro	Intel HD 520	16GB Soldered	14" WQHD (2560x1440) IPS	None	512GB SSD M.2	None	Intel 18260 ac, 2x2 + BT4.1	None	None	None	WiGig Dock	720p	Backlit	Fingerprint Reader	4-cell (52Wh)	65W	Win10 Pro 64	3-year, Depot	07/16
20FB007HUS	US	i5-6300U	vPro	Intel HD 520	8GB Soldered	14" WQHD (2560x1440) IPS	None	256GB SSD M.2 Opal2	None	Intel 18260 ac, 2x2 + BT4.1	None	None	None	WiGig Dock	720p	Backlit	Fingerprint Reader	4-cell (52Wh)	65W	Win10 Pro 64	3-year, Depot	07/16
20FB007QUS	US	i5-6200U	No	Intel HD 520	8GB Soldered	14" FHD (1920x1080) IPS	None	180GB SSD M.2 Opal2	None	Intel 8260 ac, 2x2 + BT4.1	WWAN Upgradable	None	None	None	720p	Backlit	Fingerprint Reader	4-cell (52Wh)	65W	Win10 Pro 64	3-year, Depot	08/16
20FB007RUS	US	i5-6200U	No	Intel HD 520	8GB Soldered	14" FHD (1920x1080) IPS	None	256GB SSD M.2 Opal2	None	Intel 8260 ac, 2x2 + BT4.1	None	None	None	None	720p	Backlit	Fingerprint Reader	4-cell (52Wh)	65W	Win10 Pro 64	3-year, Depot	11/16
20FBA043US	US	i5-6200U	No	Intel HD 520	8GB Soldered	14" FHD (1920x1080) IPS	None	256GB SSD M.2 Opal2	None	Intel 8260 ac, 2x2 + BT4.1	WWAN Upgradable	None	None	None	720p	Backlit	Fingerprint Reader	4-cell (52Wh)	65W	Win10 Pro 64	3-year, Depot	08/16



ThinkPad X1 Carbon (5th Gen) Platform Specifications

Product Specifications Reference (PSREF)

Processor	6th Generation Intel® Core™ i5 / i7 Processor								Smart card reader None									
	Processor Number	# of Cores	# of Threads	Base Frequency	Max Turbo Frequency	Cache	Memory Types	Processor Graphics		Media reader Ports								
	i5-6200U	2	4	2.3 GHz	2.8 GHz	3MB	LPDDR3-1866	Intel HD Graphics 520	MicroSD card reader, supports UHS-II microSD card Two USB 3.1 Gen 1 / USB 3.0 (one Always On), two USB 3.1 Type-C Gen 2 / Thunderbolt 3 / DisplayPort 1.2a / Power Delivery 2.0, HDMI 1.4b, Ethernet extension connector									
	i5-6300U			2.4 GHz	3.0 GHz	3MB												
	i7-6500U			2.5 GHz	3.1 GHz	4MB												
	i7-6600U			2.6 GHz	3.4 GHz	4MB												
	or 7th Generation Intel Core i5 / i7 Processor								WiGig dock (opt) ThinkPad WiGig dock									
	Processor Number	# of Cores	# of Threads	Base Frequency	Max Turbo Frequency	Cache	Memory Types	Processor Graphics	Monitor cable (optional)									
	i5-7200U	2	4	2.5 GHz	3.1 GHz	3MB	LPDDR3-1866	Intel HD Graphics 620	HDMI to VGA: Lenovo HDMI to VGA Monitor Adapter									
	i5-7300U			2.6 GHz	3.5 GHz	3MB			USB-C to VGA: Lenovo USB-C to VGA Adapter									
	i7-7500U			2.7 GHz	3.5 GHz	4MB			USB-C to DP: Lenovo USB-C to DisplayPort Adapter									
	i7-7600U			2.8 GHz	3.9 GHz	4MB												
Graphics	Intel HD Graphics 520 or 620 in processor; supports external digital monitor via HDMI or USB Type-C; supports three independent displays; Max resolution: 4096x2304@60Hz (USB Type-C); 4096x2160@24Hz (HDMI)								Camera (optional) 720p: HD720p resolution, fixed focus IR & 720p: IR camera and HD720p camera									
Chipset	Intel SoC (System on Chip) platform								Audio support									
Memory	8GB or 16GB / 1866MHz LPDDR3 / soldered to systemboard, no sockets								Keyboard UltraNav™									
Display	Some: 14.0" (355mm) FHD (1920x1080), anti-glare, LED backlight, IPS, 300 nits, 16:9 aspect ratio, 700:1 contrast ratio, 170° viewing angle Some: 14.0" (355mm) WQHD (2560x1440), anti-glare, LED backlight, IPS, 300 nits, 16:9 aspect ratio, 700:1 contrast ratio, 170° viewing angle								Security Security chip									
Multi-touch	None								vPro (optional) Intel vPro Technology									
Storage	Some: M.2 SSD / SATA 6.0Gb/s (e.g. xxxG SSD) Some: M.2 SSD / PCIe NVMe, PCIe 3.0 x 4, 32Gb/s (e.g. xxxG SSD PCIe NVMe)								Fingerprint reader Touch style match on chip fingerprint reader on the palm rest									
Optical	None								NFC (optional) Near Field Communication									
Ethernet	Native Intel Ethernet Connection I219-V (Non-vPro) or I219-LM (vPro) via optional ThinkPad Ethernet Extension Cable								Battery Max battery life									
WLAN	One of the following, configurable by model (WiGig can coexist with WWAN): • Intel Dual Band Wireless-AC 8260, Wi-Fi 2x2 802.11ac + BT4.1, M.2 card • Intel Dual Band Wireless-AC 8265, Wi-Fi 2x2 802.11ac + BT4.1, M.2 card • Intel Tri-Band Wireless-AC 18265, WiGig 802.11ad + Wi-Fi 2x2 802.11ac + BT4.1, M.2 card								AC adapter RapidCharge									
Bluetooth™	Bluetooth 4.1 wireless, integrated in Wi-Fi + Bluetooth combo adapter * Intel 8265ac / 18265ac card support BT4.2 but is limited to BT4.1 by Windows OS								<table border="1"> <tr> <td>AC adapter</td> <td>45W USB-C</td> <td>65W USB-C</td> </tr> <tr> <td>Charge to 80%</td> <td>Not support</td> <td>1.0 hr</td> </tr> <tr> <td>Charge to 100%</td> <td>Not support</td> <td>2.5 hr</td> </tr> </table>	AC adapter	45W USB-C	65W USB-C	Charge to 80%	Not support	1.0 hr	Charge to 100%	Not support	2.5 hr
AC adapter	45W USB-C	65W USB-C																
Charge to 80%	Not support	1.0 hr																
Charge to 100%	Not support	2.5 hr																
WWAN (optional)	One of the following, configurable by model (WWAN can coexist with WiGig): • Wireless WAN upgradable • Integrated Mobile Broadband 4G LTE-A, Qualcomm® Snapdragon™ X7 LTE-A (Sierra Wireless EM7455), M.2 card								Preload									
SIM card (opt)	Micro-SIM card slot, opt Verizon LTE (US) or Lenovo® Connect (EMEA) SIM card								Windows® 7 Professional 64 preinstalled through downgrade rights in Windows 10 Pro 64 • Lenovo Solution Center • Lenovo PowerEngage • ThinkVantage Product Recovery • ThinkVantage System Update • Adobe® Reader® • Microsoft® Office preloaded; purchase a product key to activate • McAfee® LiveSafe™ (30-day trial)									
Dimensions	WxDxH: 12.74" x 8.55" x 0.63"; 323.5mm x 217.1mm x 15.95mm								Limited warranty									
Weight	from 2.49 lb / 1.13 kg								One of the following, configurable by model: • 1-year depot repair service • 3-year/1-yr battery depot repair service • 3-year/1-yr battery limited onsite service									
Case color	Black or Silver (silver is not available in EMEA)								Mil-Spec test									
Case material	Display cover: CFRP/GFRP hybrid; Bottom: magnesium alloy hybrid								Environment									
									EPEAT™ Gold (US only); ENERGY STAR® 6.1; RoHS-compliant									

ThinkPad X1 Carbon (5th Gen) - TopSeller - 20HR

Product Specifications Reference (PSREF)

Model	Region	Processor	vPro	Graphics	Memory (Soldered)	Display	Multi-touch	Storage(HDD/SSD)	Optical	WLAN + Bluetooth	WWAN	SIM Card	Dock	Monitor Cable	Adapter	Color	Camera	Key-board	Finger-print Reader	NFC	TPM	Battery (internal)	Power Adapter	Operating System	Warranty	Ann Date (m/y)
20HR000DUS	US	i5-7300U	vPro	Intel HD 620	8GB Soldered	14" FHD (1920x1080) IPS	None	256GB SSD M.2 PCIe NVMe Opal2	None	8265 ac, 2x2 + BT4.1	None	None	None	None	None	Black	720p	Backlit	Finger-print Reader	None	dTPM 2.0	3-cell (57Wh)	65W USB-C	Windows 10 Pro 64	3-year, Depot	02/17
20HR000FUS	US	i7-7600U	vPro	Intel HD 620	16GB Soldered	14" FHD (1920x1080) IPS	None	512GB SSD M.2 PCIe NVMe Opal2	None	8265 ac, 2x2 + BT4.1	None	None	None	None	None	Black	720p	Backlit	Finger-print Reader	None	dTPM 2.0	3-cell (57Wh)	65W USB-C	Windows 10 Pro 64	3-year, Depot	02/17
20HR000HUS	US	i7-7600U	vPro	Intel HD 620	8GB Soldered	14" FHD (1920x1080) IPS	None	256GB SSD M.2 PCIe NVMe Opal2	None	8265 ac, 2x2 + BT4.1	None	None	None	None	None	Black	720p	Backlit	Finger-print Reader	None	dTPM 2.0	3-cell (57Wh)	65W USB-C	Windows 10 Pro 64	3-year, Depot	02/17
20HR000MUS	US	i5-7300U	vPro	Intel HD 620	16GB Soldered	14" FHD (1920x1080) IPS	None	256GB SSD M.2 PCIe NVMe Opal2	None	8265 ac, 2x2 + BT4.1	None	None	None	None	None	Black	720p	Backlit	Finger-print Reader	None	dTPM 2.0	3-cell (57Wh)	65W USB-C	Windows 10 Pro 64	3-year, Depot	02/17
20HR000WUS	US	i5-7200U	No	Intel HD 620	8GB Soldered	14" FHD (1920x1080) IPS	None	256GB SSD M.2 PCIe NVMe Opal2	None	8265 ac, 2x2 + BT4.1	None	None	None	None	None	Black	720p	Backlit	Finger-print Reader	None	dTPM 2.0	3-cell (57Wh)	65W USB-C	Windows 10 Pro 64	3-year, Depot	02/17
20HR0011US	US	i5-7200U	No	Intel HD 620	8GB Soldered	14" FHD (1920x1080) IPS	None	128GB SSD M.2	None	8265 ac, 2x2 + BT4.1	None	None	None	None	None	Black	720p	Backlit	Finger-print Reader	None	dTPM 2.0	3-cell (57Wh)	65W USB-C	Windows 10 Pro 64	3-year, Depot	02/17
20HR003CUS	US	i5-7300U	vPro	Intel HD 620	16GB Soldered	14" FHD (1920x1080) IPS	None	512GB SSD M.2 PCIe NVMe Opal2	None	8265 ac, 2x2 + BT4.1	None	None	None	None	None	Black	720p	Backlit	Finger-print Reader	None	dTPM 2.0	3-cell (57Wh)	65W USB-C	Windows 10 Pro 64	3-year, Depot	02/17
20HR003DUS	US	i7-7600U	vPro	Intel HD 620	8GB Soldered	14" FHD (1920x1080) IPS	None	512GB SSD M.2 PCIe NVMe Opal2	None	8265 ac, 2x2 + BT4.1	None	None	None	None	None	Black	720p	Backlit	Finger-print Reader	None	dTPM 2.0	3-cell (57Wh)	65W USB-C	Windows 10 Pro 64	3-year, Depot	02/17
20HR003EUS	US	i5-7300U	vPro	Intel HD 620	8GB Soldered	14" FHD (1920x1080) IPS	None	512GB SSD M.2 PCIe NVMe Opal2	None	8265 ac, 2x2 + BT4.1	None	None	None	None	None	Black	720p	Backlit	Finger-print Reader	None	dTPM 2.0	3-cell (57Wh)	65W USB-C	Windows 10 Pro 64	3-year, Depot	02/17



ThinkPad X250 Platform Specifications

Product Specifications Reference (PSREF)

Processor	5th Generation Intel® Core™ i3 / i5 / i7 Processor								Smart card reader	<i>Optional:</i> Smart card reader														
	Processor Number	# of Cores	# of Threads	Base Frequency	Max Turbo Frequency	Cache	Memory Types	Processor Graphics	Media reader	4-in-1 reader (MMC, SD, SDHC, SDXC)														
	i5-4300U	2	4	1.9 GHz	2.9 GHz	3MB	DDR3L-1600	Intel HD graphics 4400	Ports	Two USB 3.0 (one Always On), VGA, MiniDP, Ethernet (RJ-45), Dock connector														
	i3-5010U			2.1 GHz	-	3MB		Intel HD Graphics 5500	Camera (<i>optional</i>) HD720p resolution, low light sensitive, fixed focus															
	i5-5200U			2.2 GHz	2.7 GHz	3MB				Audio support	HD Audio, Realtek® ALC3232 codec / stereo speakers, 1.5W x 2 / dual array microphone, combo audio/microphone jack													
	i5-5300U			2.3 GHz	2.9 GHz	3MB				Keyboard	6-row, spill-resistant, multimedia Fn keys, optional LED backlight													
i7-5600U	2.6 GHz			3.2 GHz	4MB	UltraNav™				TrackPoint® pointing device and buttonless Mylar surface touchpad, multi-touch														
Graphics	Intel HD Graphics 5500 in processor, supports external analog monitor via VGA and digital monitor via Mini DisplayPort; supports three independent displays; Max resolution: 3840x2160@60Hz (DP via mDP cable); 1920x1200@60Hz (VGA)								Security	Power-on password, hard disk password, supervisor password, security keyhole														
Chipset	Intel SoC (System on Chip) platform								Security chip	Discrete TPM 1.2, TCG Certified														
Memory	16GB max / PC3-12800 1600MHz DDR3L, one 204-pin SO-DIMM socket								ThinkEngine	Delivers improved thermal and power efficiency, up to 30 day standby, faster resume time, enhanced security, as well as anti-tampering measures														
Display	<i>Some:</i> 12.5" (317.5mm) HD (1366x768), anti-glare, LED backlight, 200 nits, 16:9 aspect ratio, 300:1 contrast ratio <i>Some:</i> 12.5" (317.5mm) HD (1366x768), anti-glare, LED backlight, 300 nits, 16:9 aspect ratio, 700:1 contrast ratio, IPS <i>Some:</i> 12.5" (317.5mm) FHD (1920x1080), anti-glare, LED backlight, 400 nits, 16:9 aspect ratio, 700:1 contrast ratio, IPS								vPro (<i>optional</i>)	Intel vPro Technology														
Multi-touch (<i>opt</i>)	Capacitive-type multi-touch, supports 10-finger gesture, 270 or 360 nits								Fingerprint reader	<i>Optional:</i> Fingerprint reader on the keyboard bezel, swipe sensor														
Storage	<i>Some:</i> SSD / SATA 6.0Gb/s, 2.5" wide, 7mm high, removable, upgradable <i>Some:</i> HDD / SATA 6.0Gb/s, 2.5" wide, 7mm or 9.5mm high, removable, upgradable, Shock Mounted Hard Drive, Active Protection System™ <i>Some:</i> SSHD with 8GB NAND flash memory								Internal battery	<i>Optional:</i> Integrated Li-Ion or Li-Polymer 3-cell (23Wh)														
M.2 SSD (<i>opt</i>)	M.2 Solid State Drive (SSD), via M.2 card slot								External battery	Li-Ion 3-cell (23Wh) or 6-cell (48Wh or 72Wh)														
Optical	None								Max battery life ¹⁰	<table border="1"> <thead> <tr> <th>Models</th> <th>No + 3-cell</th> <th>3-cell + 3-cell</th> <th>3-cell + 6-cell 48Wh</th> <th>3-cell + 6-cell 72Wh</th> </tr> </thead> <tbody> <tr> <td>Battery life</td> <td>5.2 hr</td> <td>10.7 hr</td> <td>16.0 hr</td> <td>21.4 hr</td> </tr> </tbody> </table>					Models	No + 3-cell	3-cell + 3-cell	3-cell + 6-cell 48Wh	3-cell + 6-cell 72Wh	Battery life	5.2 hr	10.7 hr	16.0 hr	21.4 hr
Models	No + 3-cell	3-cell + 3-cell	3-cell + 6-cell 48Wh	3-cell + 6-cell 72Wh																				
Battery life	5.2 hr	10.7 hr	16.0 hr	21.4 hr																				
Ethernet	<i>Non-vPro model:</i> Intel Ethernet Connection I218-V (Clarkville) <i>vPro model:</i> Intel Ethernet Connection I218-LM (Clarkville)								AC adapter	45W AC adapter														
Bluetooth™	Bluetooth 4.0 wireless, integrated in Wi-Fi + Bluetooth combo adapter								Preload	Windows® 7 Professional 64 preinstalled through downgrade rights in Windows 8.1 Pro 64-bit or Windows 10 Pro 64 • Lenovo Solution Center • Lenovo SHAREit • Lenovo SHAREit • ThinkVantage Product Recovery • Rescue and Recovery™ • ThinkVantage System Update • PC Device Stage • Adobe® Reader® • Microsoft® Office preloaded; purchase a product key to activate • Norton™ Internet Security (30 days of virus definitions)														
WLAN ⁴	<i>One of the following, configurable by model:</i> • 11b/g/n, ThinkPad 11b/g/n, 2x2, Wi-Fi + Bluetooth combo adapter, M.2 card • 11b/g/n, Intel Wireless-N 7265, 2x2, Wi-Fi + Bluetooth combo adapter, M.2 card • 11a/b/g/n, Intel Dual Band Wireless-N 7265, 2x2, Wi-Fi + BT adapter, M.2 card • 11ac, Intel Dual Band Wireless-AC 7265, 2x2, Wi-Fi + BT adapter, M.2 card								Limited warranty ¹²	<i>One of the following, configurable by model:</i> • 1-year depot repair service • 3-year/1-yr battery depot repair service • 3-year/1-yr battery limited onsite service ²⁴ • 3-year/1-yr battery limited onsite service, OID (Onsite International Delivery)														
WWAN (<i>optional</i>)	<i>One of the following, configurable by model:</i> • Wireless WAN upgradable • Wireless WAN, Ericsson® N5321, HSPA+ 21Mbps/GSM/GPRS/EDGE, GPS, M.2 card • Wireless WAN, Sierra Wireless EM7345, Intel 4G LTE/HSPA/GSM/GPRS/EDGE, GPS, M.2 card								Mil-Spec test	MIL-STD-810G military certification														
SIM card (<i>opt</i>)	AT&T® or Verizon® LTE (4G), contract required with service provider								Environment	EPEAT™ Gold (US) or EPEAT Silver (WE); ENERGY STAR® 6.1; GREENGUARD®; RoHS-compliant														
Dimensions ³	12.5" (WxDxH): 12.0" x 8.21" x 0.80"; 305.5mm x 208.5mm x 20.3mm 12.5" Touch (WxDxH): 12.0" x 8.21" x 0.85"; 305.5mm x 208.5mm x 21.5mm																							
Weight ²	Models		No + 3-cell		3-cell + 3-cell		No + 6-cell		3-cell + 6-cell															
	Non-touch		2.88 lb / 1.31 kg		3.13 lb / 1.42 kg		3.23 lb / 1.47 kg		3.48 lb / 1.58 kg															
	Multi-touch		-		3.29 lb / 1.49 kg		-		3.64 lb / 1.65 kg															
Case material	<i>Display cover:</i> Glass-Fiber Reinforced Plastic (non-touch model) or Carbon-Fiber Reinforced Plastic (multi-touch model); <i>Bottom:</i> Glass-Fiber Reinforced Plastic																							

ThinkPad X250 - TopSeller - 20CM - 1 of 3

Product Specifications Reference (PSREF)

Model	Region	Processor	vPro	Graphics	Memory	Display	Multi-touch	Storage	M.2 SSD	Optical	WLAN + Bluetooth	WWAN	SIM Card	Smart Card Reader	Camera	Keyboard	Fingerprint Reader	Battery (internal+ external)	Power Adapter	Operating System	Warranty	Ann Date (m/y)
20CM002VUS	US	i5-5300U	vPro	Intel HD 5500	4GBx1	12.5" HD (1366x768)	None	500GB 7200rpm	None	None	Intel 7265 ac, 2x2 + BT4.0	WWAN Upgradable	None	None	720p	Backlit	Fingerprint Reader	None + 6-cell(48Wh)	45W	Win8.1 DG Win7 Pro 64	3-year, Depot	01/15
20CM002WUS	US	i7-5600U	vPro	Intel HD 5500	8GBx1	12.5" HD (1366x768)	None	256GB SSD Opal2	None	None	Intel 7265 ac, 2x2 + BT4.0	WWAN Upgradable	None	None	720p	Backlit	Fingerprint Reader	3-cell(23Wh) + 3-cell(23Wh)	45W	Win8.1 DG Win7 Pro 64	3-year, Depot	01/15
20CM002XUS	US	i5-5200U	No	Intel HD 5500	8GBx1	12.5" HD (1366x768)	None	500GB 7200rpm	16GB SSD	None	Intel 7265 ac, 2x2 + BT4.0	WWAN Upgradable	None	None	720p	Backlit	Fingerprint Reader	3-cell(23Wh) + 3-cell(23Wh)	45W	Win8.1 DG Win7 Pro 64	3-year, Depot	01/15
20CM002YUS	US	i5-5300U	vPro	Intel HD 5500	8GBx1	12.5" HD (1366x768)	None	500GB 7200rpm	16GB SSD	None	Intel 7265 ac, 2x2 + BT4.0	WWAN Upgradable	None	None	720p	Backlit	Fingerprint Reader	3-cell(23Wh) + 3-cell(23Wh)	45W	Win8.1 DG Win7 Pro 64	3-year, Depot	01/15
20CM0030US	US	i5-5300U	vPro	Intel HD 5500	4GBx1	12.5" HD (1366x768)	None	500GB 7200rpm	16GB SSD	None	Intel 7265 ac, 2x2 + BT4.0	WWAN Upgradable	None	None	720p	Backlit	Fingerprint Reader	3-cell(23Wh) + 3-cell(23Wh)	45W	Win8.1 DG Win7 Pro 64	3-year, Depot	01/15
20CM0031US	US	i5-5300U	vPro	Intel HD 5500	4GBx1	12.5" HD (1366x768)	None	500GB 5400rpm	16GB SSD	None	Intel 7265 ac, 2x2 + BT4.0	WWAN Upgradable	None	None	720p	Backlit	Fingerprint Reader	3-cell(23Wh) + 3-cell(23Wh)	45W	Win8.1 DG Win7 Pro 64	3-year, Depot	01/15
20CM0032US	US	i5-5300U	vPro	Intel HD 5500	8GBx1	12.5" HD (1366x768)	None	500GB 7200rpm	None	None	Intel 7265 ac, 2x2 + BT4.0	WWAN Upgradable	None	None	720p	Backlit	Fingerprint Reader	None + 6-cell(48Wh)	45W	Win8.1 DG Win7 Pro 64	3-year, Depot	01/15
20CM0033US	US	i5-5300U	vPro	Intel HD 5500	8GBx1	12.5" HD (1366x768)	None	180GB SSD Opal2	None	None	Intel 7265 ac, 2x2 + BT4.0	WWAN Upgradable	None	None	720p	Backlit	Fingerprint Reader	3-cell(23Wh) + 3-cell(23Wh)	45W	Win8.1 DG Win7 Pro 64	3-year, Depot	01/15
20CM0034US	US	i5-5300U	vPro	Intel HD 5500	4GBx1	12.5" HD (1366x768)	None	500GB 7200rpm	None	None	Intel 7265 ac, 2x2 + BT4.0	WWAN Upgradable	None	None	720p	Backlit	Fingerprint Reader	3-cell(23Wh) + 3-cell(23Wh)	45W	Win8.1 DG Win7 Pro 64	3-year, Depot	01/15
20CM0035US	US	i5-5300U	vPro	Intel HD 5500	4GBx1	12.5" HD (1366x768) IPS	None	500GB 7200rpm	16GB SSD	None	Intel 7265 ac, 2x2 + BT4.0	WWAN Upgradable	None	None	720p	Backlit	Fingerprint Reader	3-cell(23Wh) + 3-cell(23Wh)	45W	Win8.1 DG Win7 Pro 64	3-year, Depot	01/15
20CM0036US	US	i5-5200U	No	Intel HD 5500	4GBx1	12.5" HD (1366x768)	None	500GB 7200rpm	16GB SSD	None	Intel 7265 ac, 2x2 + BT4.0	WWAN Upgradable	None	None	720p	Backlit	Fingerprint Reader	3-cell(23Wh) + 3-cell(23Wh)	45W	Win8.1 DG Win7 Pro 64	3-year, Depot	01/15
20CM0046US	US	i5-5300U	vPro	Intel HD 5500	8GBx1	12.5" HD (1366x768) IPS	None	180GB SSD Opal2	None	None	Intel 7265 ac, 2x2 + BT4.0	WWAN Upgradable	None	None	720p	Backlit	Fingerprint Reader	3-cell(23Wh) + 3-cell(23Wh)	45W	Win8.1 DG Win7 Pro 64	3-year, Depot	03/15
20CM0047US	US	i5-5300U	vPro	Intel HD 5500	8GBx1	12.5" HD (1366x768) IPS	None	256GB SSD Opal2	None	None	Intel 7265 ac, 2x2 + BT4.0	WWAN Upgradable	None	None	720p	Backlit	Fingerprint Reader	3-cell(23Wh) + 3-cell(23Wh)	45W	Win8.1 DG Win7 Pro 64	3-year, Depot	03/15
20CM0048US	US	i7-5600U	vPro	Intel HD 5500	8GBx1	12.5" HD (1366x768) IPS	None	256GB SSD Opal2	None	None	Intel 7265 ac, 2x2 + BT4.0	WWAN Upgradable	None	None	720p	Backlit	Fingerprint Reader	3-cell(23Wh) + 3-cell(23Wh)	45W	Win8.1 DG Win7 Pro 64	3-year, Depot	03/15
20CM0049US	US	i5-5300U	vPro	Intel HD 5500	8GBx1	12.5" HD (1366x768) IPS	None	500GB 5400rpm	16GB SSD	None	Intel 7265 ac, 2x2 + BT4.0	WWAN Upgradable	None	None	720p	Backlit	Fingerprint Reader	3-cell(23Wh) + 3-cell(23Wh)	45W	Win8.1 DG Win7 Pro 64	3-year, Depot	03/15
20CM004FUS	US	i5-5300U	vPro	Intel HD 5500	4GBx1	12.5" FHD (1920x1080) IPS	10-point Multi-touch	500GB 7200rpm Opal	None	None	Intel 7265 ac, 2x2 + BT4.0	WWAN Upgradable	None	None	720p	Backlit	Fingerprint Reader	3-cell(23Wh) + 3-cell(23Wh)	45W	Win8.1 DG Win7 Pro 64	3-year, Depot	05/15
20CM004GUS	US	i7-5600U	vPro	Intel HD 5500	8GBx1	12.5" FHD (1920x1080) IPS	10-point Multi-touch	500GB 7200rpm Opal	None	None	Intel 7265 ac, 2x2 + BT4.0	WWAN Upgradable	None	None	720p	Backlit	Fingerprint Reader	3-cell(23Wh) + 3-cell(23Wh)	45W	Win8.1 DG Win7 Pro 64	3-year, Depot	05/15
20CM004HUS	US	i7-5600U	vPro	Intel HD 5500	8GBx1	12.5" FHD (1920x1080) IPS	10-point Multi-touch	256GB SSD Opal2	None	None	Intel 7265 ac, 2x2 + BT4.0	WWAN Upgradable	None	None	720p	Backlit	Fingerprint Reader	3-cell(23Wh) + 3-cell(23Wh)	45W	Win8.1 DG Win7 Pro 64	3-year, Depot	05/15
20CM005GUS	US	i5-5200U	No	Intel HD 5500	4GBx1	12.5" HD (1366x768) IPS	None	500GB 7200rpm Opal	None	None	Intel 7265 ac, 2x2 + BT4.0	WWAN Upgradable	None	None	720p	Backlit	Fingerprint Reader	3-cell(23Wh) + 3-cell(23Wh)	45W	Win10 DG Win7 Pro 64	3-year, Depot	08/15
20CM005HUS	US	i5-5200U	No	Intel HD 5500	4GBx1	12.5" HD (1366x768) IPS	None	500GB 7200rpm	None	None	Intel 7265 ac, 2x2 + BT4.0	WWAN Upgradable	None	None	720p	Backlit	Fingerprint Reader	3-cell(23Wh) + 3-cell(23Wh)	45W	Win10 DG Win7 Pro 64	3-year, Depot	08/15

Model	Region	Processor	vPro	Graphics	Memory	Display	Multi-touch	Storage	M.2 SSD	Optical	WLAN + Bluetooth	WWAN	SIM Card	Smart Card Reader	Camera	Keyboard	Fingerprint Reader	Battery (internal+external)	Power Adapter	Operating System	Warranty	Ann Date (m/y)
20CM005JUS	US	i5-5300U	vPro	Intel HD 5500	4GBx1	12.5" HD (1366x768) IPS	None	500GB 7200rpm	16GB SSD	None	Intel 7265 ac, 2x2 + BT4.0	WWAN Upgradable	None	None	720p	Backlit	Fingerprint Reader	3-cell(23Wh) + 3-cell(23Wh)	45W	Win10 DG Win7 Pro 64	3-year, Depot	08/15
20CM005KUS	US	i5-5300U	vPro	Intel HD 5500	8GBx1	12.5" HD (1366x768) IPS	None	500GB 7200rpm	16GB SSD	None	Intel 7265 ac, 2x2 + BT4.0	WWAN Upgradable	None	None	720p	Backlit	Fingerprint Reader	3-cell(23Wh) + 3-cell(23Wh)	45W	Win10 DG Win7 Pro 64	3-year, Depot	08/15
20CM005LUS	US	i5-5300U	vPro	Intel HD 5500	8GBx1	12.5" HD (1366x768) IPS	None	256GB SSD Opal2	None	None	Intel 7265 ac, 2x2 + BT4.0	WWAN Upgradable	None	None	720p	Backlit	Fingerprint Reader	3-cell(23Wh) + 3-cell(23Wh)	45W	Win10 DG Win7 Pro 64	3-year, Depot	08/15
20CM005MUS	US	i7-5600U	vPro	Intel HD 5500	8GBx1	12.5" HD (1366x768) IPS	None	256GB SSD Opal2	None	None	Intel 7265 ac, 2x2 + BT4.0	WWAN Upgradable	None	None	720p	Backlit	Fingerprint Reader	3-cell(23Wh) + 3-cell(23Wh)	45W	Win10 DG Win7 Pro 64	3-year, Depot	08/15
20CM005NUS	US	i7-5600U	vPro	Intel HD 5500	16GBx1	12.5" HD (1366x768) IPS	None	256GB SSD Opal2	None	None	Intel 7265 ac, 2x2 + BT4.0	WWAN Upgradable	None	None	720p	Backlit	Fingerprint Reader	3-cell(23Wh) + 3-cell(23Wh)	45W	Win10 DG Win7 Pro 64	3-year, Depot	08/15
20CM005PUS	US	i5-5300U	vPro	Intel HD 5500	8GBx1	12.5" HD (1366x768) IPS	None	128GB SSD	None	None	Intel 7265 ac, 2x2 + BT4.0	WWAN Upgradable	None	None	720p	Backlit	Fingerprint Reader	3-cell(23Wh) + 3-cell(23Wh)	45W	Win10 DG Win7 Pro 64	3-year, Depot	08/15
20CM005QUS	US	i7-5600U	vPro	Intel HD 5500	8GBx1	12.5" HD (1366x768) IPS	None	512GB SSD	None	None	Intel 7265 ac, 2x2 + BT4.0	WWAN Upgradable	None	None	720p	Backlit	Fingerprint Reader	3-cell(23Wh) + 3-cell(23Wh)	45W	Win10 DG Win7 Pro 64	3-year, Depot	08/15
20CM005RUS	US	i5-4300U	vPro	Intel HD 5500	8GBx1	12.5" HD (1366x768) IPS	None	500GB 7200rpm	16GB SSD	None	Intel 7265 ac, 2x2 + BT4.0	WWAN Upgradable	None	None	720p	Backlit	Fingerprint Reader	3-cell(23Wh) + 3-cell(23Wh)	45W	Win10 DG Win7 Pro 64	3-year, Depot	08/15
20CM005SUS	US	i5-5300U	vPro	Intel HD 5500	8GBx1	12.5" HD (1366x768) IPS	10-point Multi-touch	500GB 7200rpm	16GB SSD	None	Intel 7265 ac, 2x2 + BT4.0	WWAN Upgradable	None	None	720p	Backlit	Fingerprint Reader	3-cell(23Wh) + 3-cell(23Wh)	45W	Win10 DG Win7 Pro 64	3-year, Depot	08/15
20CM005TUS	US	i5-5300U	vPro	Intel HD 5500	8GBx1	12.5" HD (1366x768) IPS	10-point Multi-touch	128GB SSD	None	None	Intel 7265 ac, 2x2 + BT4.0	WWAN Upgradable	None	None	720p	Backlit	Fingerprint Reader	3-cell(23Wh) + 3-cell(23Wh)	45W	Win10 DG Win7 Pro 64	3-year, Depot	08/15
20CM005UUS	US	i7-5600U	vPro	Intel HD 5500	8GBx1	12.5" HD (1366x768) IPS	10-point Multi-touch	128GB SSD	None	None	Intel 7265 ac, 2x2 + BT4.0	WWAN Upgradable	None	None	720p	Backlit	Fingerprint Reader	3-cell(23Wh) + 3-cell(23Wh)	45W	Win10 DG Win7 Pro 64	3-year, Depot	08/15
20CM005VUS	US	i7-5600U	vPro	Intel HD 5500	8GBx1	12.5" HD (1366x768) IPS	10-point Multi-touch	256GB SSD Opal2	None	None	Intel 7265 ac, 2x2 + BT4.0	WWAN Upgradable	None	None	720p	Backlit	Fingerprint Reader	3-cell(23Wh) + 3-cell(23Wh)	45W	Win10 DG Win7 Pro 64	3-year, Depot	08/15
20CM005WUS	US	i5-5300U	vPro	Intel HD 5500	4GBx1	12.5" HD (1366x768) IPS	10-point Multi-touch	500GB 7200rpm	16GB SSD	None	Intel 7265 ac, 2x2 + BT4.0	WWAN Upgradable	None	None	720p	Backlit	Fingerprint Reader	3-cell(23Wh) + 3-cell(23Wh)	45W	Win10 DG Win7 Pro 64	3-year, Depot	08/15
20CM005XUS	US	i7-5600U	vPro	Intel HD 5500	4GBx1	12.5" FHD (1920x1080) IPS	10-point Multi-touch	512GB SSD	None	None	Intel 7265 ac, 2x2 + BT4.0	WWAN Upgradable	None	None	720p	Backlit	Fingerprint Reader	3-cell(23Wh) + 3-cell(23Wh)	45W	Win10 DG Win7 Pro 64	3-year, Depot	08/15
20CM005YUS	US	i7-5600U	vPro	Intel HD 5500	16GBx1	12.5" FHD (1920x1080) IPS	10-point Multi-touch	512GB SSD	None	None	Intel 7265 ac, 2x2 + BT4.0	WWAN Upgradable	None	None	720p	Backlit	Fingerprint Reader	3-cell(23Wh) + 3-cell(23Wh)	45W	Win10 DG Win7 Pro 64	3-year, Depot	08/15
20CM0060US	US	i5-5300U	vPro	Intel HD 5500	8GBx1	12.5" FHD (1920x1080) IPS	10-point Multi-touch	256GB SSD Opal2	None	None	Intel 7265 ac, 2x2 + BT4.0	WWAN Upgradable	None	None	720p	Backlit	Fingerprint Reader	3-cell(23Wh) + 3-cell(23Wh)	45W	Win10 DG Win7 Pro 64	3-year, Depot	08/15
20CM0083US	US	i7-5600U	vPro	Intel HD 5500	8GBx1	12.5" HD (1366x768) IPS	None	500GB 7200rpm	16GB SSD	None	Intel 7265 ac, 2x2 + BT4.0	WWAN Upgradable	None	None	720p	Backlit	Fingerprint Reader	3-cell(23Wh) + 3-cell(23Wh)	45W	Win10 Pro 64	3-year, Depot	09/15
20CM0084US	US	i7-5600U	vPro	Intel HD 5500	8GBx1	12.5" HD (1366x768) IPS	None	256GB SSD Opal2	None	None	Intel 7265 ac, 2x2 + BT4.0	WWAN Upgradable	None	Smart Card Reader	720p	Backlit	Fingerprint Reader	3-cell(23Wh) + 3-cell(23Wh)	45W	Win10 Pro 64	3-year, Depot	09/15
20CM0085US	US	i5-5200U	No	Intel HD 5500	4GBx1	12.5" HD (1366x768) IPS	None	500GB 7200rpm	16GB SSD	None	Intel 7265 ac, 2x2 + BT4.0	WWAN Upgradable	None	None	720p	Backlit	Fingerprint Reader	3-cell(23Wh) + 3-cell(23Wh)	45W	Win10 Pro 64	3-year, Depot	09/15
20CM0086US	US	i7-5600U	vPro	Intel HD 5500	16GBx1	12.5" HD (1366x768) IPS	None	256GB SSD Opal2	None	None	Intel 7265 ac, 2x2 + BT4.0	WWAN Upgradable	None	Smart Card Reader	720p	Backlit	Fingerprint Reader	3-cell(23Wh) + 3-cell(23Wh)	45W	Win10 Pro 64	3-year, Depot	09/15

Model	Region	Processor	vPro	Graphics	Memory	Display	Multi-touch	Storage	M.2 SSD	Optical	WLAN + Bluetooth	WWAN	SIM Card	Smart Card Reader	Camera	Keyboard	Fingerprint Reader	Battery (internal+external)	Power Adapter	Operating System	Warranty	Ann Date (m/y)
20CM0087US	US	i5-5300U	vPro	Intel HD 5500	8GBx1	12.5" FHD (1920x1080) IPS	10-point Multi-touch	180GB SSD Opal2	None	None	Intel 7265 ac, 2x2 + BT4.0	WWAN Upgradable	None	None	720p	Backlit	Fingerprint Reader	3-cell(23Wh) + 3-cell(23Wh)	45W	Win10 Pro 64	3-year, Depot	09/15
20CM0088US	US	i5-5300U	vPro	Intel HD 5500	8GBx1	12.5" FHD (1920x1080) IPS	10-point Multi-touch	256GB SSD Opal2	None	None	Intel 7265 ac, 2x2 + BT4.0	WWAN Upgradable	None	None	720p	Backlit	Fingerprint Reader	3-cell(23Wh) + 3-cell(23Wh)	45W	Win10 Pro 64	3-year, Depot	09/15
20CM0089US	US	i7-5600U	vPro	Intel HD 5500	8GBx1	12.5" FHD (1920x1080) IPS	10-point Multi-touch	256GB SSD Opal2	None	None	Intel 7265 ac, 2x2 + BT4.0	WWAN Upgradable	None	None	720p	Backlit	Fingerprint Reader	3-cell(23Wh) + 3-cell(23Wh)	45W	Win10 Pro 64	3-year, Depot	09/15
20CM008AUS	US	i7-5600U	vPro	Intel HD 5500	16GBx1	12.5" FHD (1920x1080) IPS	10-point Multi-touch	256GB SSD Opal2	None	None	Intel 7265 ac, 2x2 + BT4.0	WWAN Upgradable	None	None	720p	Backlit	Fingerprint Reader	3-cell(23Wh) + 3-cell(23Wh)	45W	Win10 Pro 64	3-year, Depot	09/15
20CM008BUS	US	i5-5300U	vPro	Intel HD 5500	8GBx1	12.5" HD (1366x768) IPS	None	500GB 7200rpm	16GB SSD	None	Intel 7265 ac, 2x2 + BT4.0	WWAN Upgradable	None	None	720p	Backlit	Fingerprint Reader	3-cell(23Wh) + 3-cell(23Wh)	45W	Win10 Pro 64	3-year, Depot	09/15
20CM008DUS	US	i5-5300U	vPro	Intel HD 5500	8GBx1	12.5" HD (1366x768) IPS	None	500GB 7200rpm	16GB SSD	None	Intel 7265 ac, 2x2 + BT4.0	WWAN Upgradable	None	None	720p	Backlit	Fingerprint Reader	3-cell(23Wh) + 3-cell(23Wh)	45W	Win10 DG Win7 Pro 64	3-year, Depot	09/15
20CM008EUS	US	i5-5200U	No	Intel HD 5500	8GBx1	12.5" HD (1366x768) IPS	None	500GB 7200rpm	16GB SSD	None	Intel 7265 ac, 2x2 + BT4.0	WWAN Upgradable	None	None	720p	Backlit	Fingerprint Reader	3-cell(23Wh) + 3-cell(23Wh)	45W	Win10 DG Win7 Pro 64	3-year, Depot	09/15
20CM008FUS	US	i5-5300U	vPro	Intel HD 5500	8GBx1	12.5" HD (1366x768) IPS	None	180GB SSD Opal2	None	None	Intel 7265 ac, 2x2 + BT4.0	WWAN Upgradable	None	None	720p	Backlit	Fingerprint Reader	3-cell(23Wh) + 3-cell(23Wh)	45W	Win10 DG Win7 Pro 64	3-year, Depot	09/15
20CM008GUS	US	i5-5200U	No	Intel HD 5500	8GBx1	12.5" HD (1366x768) IPS	None	500GB 7200rpm Opal	None	None	Intel 7265 ac, 2x2 + BT4.0	WWAN Upgradable	None	None	720p	Backlit	Fingerprint Reader	3-cell(23Wh) + 3-cell(23Wh)	45W	Win10 DG Win7 Pro 64	3-year, Depot	09/15
20CM008HUS	US	i5-5200U	No	Intel HD 5500	8GBx1	12.5" HD (1366x768) IPS	None	128GB SSD	None	None	Intel 7265 ac, 2x2 + BT4.0	WWAN Upgradable	None	None	720p	Backlit	Fingerprint Reader	3-cell(23Wh) + 3-cell(23Wh)	45W	Win10 DG Win7 Pro 64	3-year, Depot	09/15
20CMA00FUS	US	i7-5600U	vPro	Intel HD 5500	8GBx1	12.5" FHD (1920x1080) IPS	None	256GB SSD Opal2	None	None	Intel 7265 ac, 2x2 + BT4.0	WWAN Upgradable	None	None	720p	Backlit	Fingerprint Reader	3-cell(23Wh) + 3-cell(23Wh)	45W	Win8.1 DG Win7 Pro 64	3-year, Depot	03/15

Model	Region	Processor	vPro	Graphics	Memory	Display	Multi-touch	Storage	M.2 SSD	Optical	WLAN + Bluetooth	WWAN	SIM Card	Smart Card Reader	Camera	Keyboard	Fingerprint Reader	Battery (internal+external)	Power Adapter	Operating System	Warranty	Ann Date (m/y)
20CL0019US	US	i5-5300U	vPro	Intel HD 5500	4GBx1	12.5" HD (1366x768) IPS	None	500GB 7200rpm	16GB SSD	None	Intel 7265 ac, 2x2 + BT4.0	WWAN Upgradable	None	None	720p	Backlit	Fingerprint Reader	3-cell(23Wh) + 3-cell(23Wh)	45W	Win8.1 DG Win7 Pro 64	3-year, Depot	01/15
20CL001AUS	US	i5-5300U	vPro	Intel HD 5500	8GBx1	12.5" HD (1366x768)	None	500GB 7200rpm	None	None	Intel 7265 ac, 2x2 + BT4.0	WWAN Upgradable	None	None	720p	Backlit	Fingerprint Reader	None + 6-cell(48Wh)	45W	Win8.1 DG Win7 Pro 64	3-year, Depot	01/15
20CL001BUS	US	i7-5600U	vPro	Intel HD 5500	8GBx1	12.5" HD (1366x768) IPS	None	500GB 7200rpm	16GB SSD	None	Intel 7265 ac, 2x2 + BT4.0	WWAN Upgradable	None	None	720p	Backlit	Fingerprint Reader	3-cell(23Wh) + 3-cell(23Wh)	45W	Win8.1 DG Win7 Pro 64	3-year, Onsite	01/15
20CL001CUS	US	i5-5300U	vPro	Intel HD 5500	8GBx1	12.5" HD (1366x768) IPS	10-point Multi-touch	256GB SSD Opal2	None	None	Intel 7265 ac, 2x2 + BT4.0	WWAN Upgradable	None	None	720p	Backlit	Fingerprint Reader	3-cell(23Wh) + 3-cell(23Wh)	45W	Win8.1 Pro 64-bit	3-year, Onsite	01/15
20CL001DUS	US	i5-5300U	vPro	Intel HD 5500	8GBx1	12.5" HD (1366x768) IPS	None	256GB SSD Opal2	None	None	Intel 7265 ac, 2x2 + BT4.0	WWAN Upgradable	None	None	720p	Backlit	Fingerprint Reader	3-cell(23Wh) + 3-cell(23Wh)	45W	Win8.1 DG Win7 Pro 64	3-year, Onsite	01/15
20CL001EUS	US	i7-5600U	vPro	Intel HD 5500	8GBx1	12.5" HD (1366x768) IPS	10-point Multi-touch	256GB SSD Opal2	None	None	Intel 7265 ac, 2x2 + BT4.0	WWAN Upgradable	None	None	720p	Backlit	Fingerprint Reader	3-cell(23Wh) + 3-cell(23Wh)	45W	Win8.1 Pro 64-bit	3-year, Onsite	01/15
20CL001FUS	US	i5-5300U	vPro	Intel HD 5500	8GBx1	12.5" HD (1366x768) IPS	None	500GB 7200rpm	16GB SSD	None	Intel 7265 ac, 2x2 + BT4.0	WWAN Upgradable	None	None	720p	Backlit	Fingerprint Reader	3-cell(23Wh) + 3-cell(23Wh)	45W	Win8.1 DG Win7 Pro 64	3-year, Onsite	01/15
20CL001GUS	US	i5-5300U	vPro	Intel HD 5500	4GBx1	12.5" HD (1366x768)	None	500GB 7200rpm	None	None	Intel 7265 ac, 2x2 + BT4.0	WWAN Upgradable	None	None	720p	Backlit	Fingerprint Reader	3-cell(23Wh) + 3-cell(23Wh)	45W	Win8.1 DG Win7 Pro 64	3-year, Onsite	01/15
20CL001HUS	US	i5-5300U	vPro	Intel HD 5500	4GBx1	12.5" HD (1366x768)	None	500GB 7200rpm	None	None	Intel 7265 ac, 2x2 + BT4.0	WWAN Upgradable	None	None	720p	Backlit	Fingerprint Reader	None + 6-cell(48Wh)	45W	Win8.1 DG Win7 Pro 64	3-year, Depot	01/15
20CL001JUS	US	i5-5300U	vPro	Intel HD 5500	8GBx1	12.5" HD (1366x768)	None	500GB 7200rpm	16GB SSD	None	Intel 7265 ac, 2x2 + BT4.0	WWAN Upgradable	None	None	720p	Backlit	Fingerprint Reader	3-cell(23Wh) + 3-cell(23Wh)	45W	Win8.1 DG Win7 Pro 64	3-year, Onsite	01/15
20CL001KUS	US	i5-5300U	vPro	Intel HD 5500	4GBx1	12.5" HD (1366x768)	None	500GB 7200rpm	None	None	Intel 7265 ac, 2x2 + BT4.0	WWAN Upgradable	None	None	720p	Backlit	Fingerprint Reader	3-cell(23Wh) + 3-cell(23Wh)	45W	Win8.1 DG Win7 Pro 64	3-year, Depot	01/15
20CL001LUS	US	i7-5600U	vPro	Intel HD 5500	8GBx1	12.5" HD (1366x768) IPS	None	256GB SSD Opal2	None	None	Intel 7265 ac, 2x2 + BT4.0	WWAN Upgradable	None	None	720p	Backlit	Fingerprint Reader	3-cell(23Wh) + 3-cell(23Wh)	45W	Win8.1 DG Win7 Pro 64	3-year, Onsite	01/15
20CL001MUS	US	i5-5300U	vPro	Intel HD 5500	4GBx1	12.5" HD (1366x768)	None	500GB 7200rpm	16GB SSD	None	Intel 7265 ac, 2x2 + BT4.0	WWAN Upgradable	None	None	720p	Backlit	Fingerprint Reader	3-cell(23Wh) + 3-cell(23Wh)	45W	Win8.1 DG Win7 Pro 64	3-year, Depot	01/15
20CL001NUS	US	i5-5300U	vPro	Intel HD 5500	8GBx1	12.5" HD (1366x768) IPS	None	180GB SSD Opal2	None	None	Intel 7265 ac, 2x2 + BT4.0	WWAN Upgradable	None	None	720p	Backlit	Fingerprint Reader	3-cell(23Wh) + 3-cell(23Wh)	45W	Win8.1 DG Win7 Pro 64	3-year, Onsite	01/15
20CL0059US	US	i7-5600U	vPro	Intel HD 5500	8GBx1	12.5" FHD (1920x1080) IPS	10-point Multi-touch	500GB 7200rpm	16GB SSD	None	Intel 7265 ac, 2x2 + BT4.0	WWAN Upgradable	None	None	720p	Backlit	Fingerprint Reader	3-cell(23Wh) + 3-cell(23Wh)	45W	Win8.1 DG Win7 Pro 64	3-year, Depot	05/15
20CL005AUS	US	i5-5300U	vPro	Intel HD 5500	8GBx1	12.5" FHD (1920x1080) IPS	10-point Multi-touch	500GB 7200rpm	16GB SSD	None	Intel 7265 ac, 2x2 + BT4.0	WWAN Upgradable	None	None	720p	Backlit	Fingerprint Reader	3-cell(23Wh) + 3-cell(23Wh)	45W	Win8.1 DG Win7 Pro 64	3-year, Depot	05/15
20CL00A0US	US	i5-4300U	vPro	Intel HD 5500	4GBx1	12.5" HD (1366x768) IPS	None	500GB 7200rpm	16GB SSD	None	Intel 7265 ac, 2x2 + BT4.0	WWAN Upgradable	None	None	720p	Non-backlit	Fingerprint Reader	3-cell(23Wh) + 3-cell(23Wh)	45W	Win10 DG Win7 Pro 64	3-year, Onsite	08/15
20CL00A1US	US	i5-5200U	No	Intel HD 5500	4GBx1	12.5" HD (1366x768) IPS	None	500GB 7200rpm	16GB SSD	None	Intel 7265 ac, 2x2 + BT4.0	WWAN Upgradable	None	None	720p	Non-backlit	Fingerprint Reader	3-cell(23Wh) + 3-cell(23Wh)	45W	Win10 DG Win7 Pro 64	3-year, Onsite	08/15
20CL00A2US	US	i5-5300U	vPro	Intel HD 5500	8GBx1	12.5" HD (1366x768) IPS	None	500GB 7200rpm	16GB SSD	None	Intel 7265 ac, 2x2 + BT4.0	WWAN Upgradable	None	None	720p	Non-backlit	Fingerprint Reader	3-cell(23Wh) + 3-cell(23Wh)	45W	Win10 DG Win7 Pro 64	3-year, Onsite	08/15
20CL00A3US	US	i5-5300U	vPro	Intel HD 5500	8GBx1	12.5" HD (1366x768) IPS	None	128GB SSD	None	None	Intel 7265 ac, 2x2 + BT4.0	WWAN Upgradable	None	None	720p	Non-backlit	Fingerprint Reader	3-cell(23Wh) + 3-cell(23Wh)	45W	Win10 DG Win7 Pro 64	3-year, Onsite	08/15

Model	Region	Processor	vPro	Graphics	Memory	Display	Multi-touch	Storage	M.2 SSD	Optical	WLAN + Bluetooth	WWAN	SIM Card	Smart Card Reader	Camera	Keyboard	Fingerprint Reader	Battery (internal+external)	Power Adapter	Operating System	Warranty	Ann Date (m/y)
20CL00A4US	US	i7-5600U	vPro	Intel HD 5500	8GBx1	12.5" HD (1366x768) IPS	None	128GB SSD	None	None	Intel 7265 ac, 2x2 + BT4.0	WWAN Upgradable	None	None	720p	Non-backlit	Fingerprint Reader	3-cell(23Wh) + 3-cell(23Wh)	45W	Win10 DG Win7 Pro 64	3-year, Onsite	08/15
20CL00A5US	US	i7-5600U	vPro	Intel HD 5500	8GBx1	12.5" HD (1366x768) IPS	None	256GB SSD Opal2	None	None	Intel 7265 ac, 2x2 + BT4.0	WWAN Upgradable	None	None	720p	Non-backlit	Fingerprint Reader	3-cell(23Wh) + 3-cell(23Wh)	45W	Win10 DG Win7 Pro 64	3-year, Onsite	08/15
20CL00A6US	US	i7-5600U	vPro	Intel HD 5500	8GBx1	12.5" HD (1366x768) IPS	10-point Multi-touch	256GB SSD Opal2	None	None	Intel 7265 ac, 2x2 + BT4.0	WWAN Upgradable	None	None	720p	Non-backlit	Fingerprint Reader	3-cell(23Wh) + 3-cell(23Wh)	45W	Win10 DG Win7 Pro 64	3-year, Onsite	08/15
20CL00A7US	US	i7-5600U	vPro	Intel HD 5500	8GBx1	12.5" HD (1366x768) IPS	10-point Multi-touch	128GB SSD	None	None	Intel 7265 ac, 2x2 + BT4.0	WWAN Upgradable	None	None	720p	Non-backlit	Fingerprint Reader	3-cell(23Wh) + 3-cell(23Wh)	45W	Win10 DG Win7 Pro 64	3-year, Onsite	08/15
20CL00A8US	US	i5-5300U	vPro	Intel HD 5500	8GBx1	12.5" HD (1366x768) IPS	10-point Multi-touch	500GB 7200rpm	16GB SSD	None	Intel 7265 ac, 2x2 + BT4.0	WWAN Upgradable	None	None	720p	Non-backlit	Fingerprint Reader	3-cell(23Wh) + 3-cell(23Wh)	45W	Win10 DG Win7 Pro 64	3-year, Onsite	08/15
20CL00A9US	US	i5-5300U	vPro	Intel HD 5500	8GBx1	12.5" FHD (1920x1080) IPS	10-point Multi-touch	500GB 7200rpm	16GB SSD	None	Intel 7265 ac, 2x2 + BT4.0	WWAN Upgradable	None	None	720p	Non-backlit	Fingerprint Reader	3-cell(23Wh) + 3-cell(23Wh)	45W	Win10 DG Win7 Pro 64	3-year, Onsite	08/15
20CL00AAUS	US	i7-5600U	vPro	Intel HD 5500	8GBx1	12.5" FHD (1920x1080) IPS	10-point Multi-touch	256GB SSD Opal2	None	None	Intel 7265 ac, 2x2 + BT4.0	WWAN Upgradable	None	None	720p	Non-backlit	Fingerprint Reader	3-cell(23Wh) + 3-cell(23Wh)	45W	Win10 DG Win7 Pro 64	3-year, Onsite	08/15
20CL00ABUS	US	i7-5600U	vPro	Intel HD 5500	8GBx1	12.5" FHD (1920x1080) IPS	10-point Multi-touch	128GB SSD	None	None	Intel 7265 ac, 2x2 + BT4.0	WWAN Upgradable	None	None	720p	Non-backlit	Fingerprint Reader	3-cell(23Wh) + 3-cell(23Wh)	45W	Win10 DG Win7 Pro 64	3-year, Onsite	08/15
20CL00BJUS	US	i7-5600U	vPro	Intel HD 5500	8GBx1	12.5" HD (1366x768) IPS	None	256GB SSD Opal2	None	None	Intel 7265 ac, 2x2 + BT4.0	WWAN Upgradable	None	None	720p	Backlit	Fingerprint Reader	3-cell(23Wh) + 3-cell(23Wh)	45W	Win10 Pro 64	3-year, Onsite	09/15
20CL00BKUS	US	i7-5600U	vPro	Intel HD 5500	8GBx1	12.5" FHD (1920x1080) IPS	10-point Multi-touch	500GB 7200rpm	16GB SSD	None	Intel 7265 ac, 2x2 + BT4.0	WWAN Upgradable	None	None	720p	Backlit	Fingerprint Reader	3-cell(23Wh) + 3-cell(23Wh)	45W	Win10 Pro 64	3-year, Onsite	09/15
20CL00BLUS	US	i5-5200U	No	Intel HD 5500	4GBx1	12.5" FHD (1920x1080) IPS	10-point Multi-touch	500GB 7200rpm	16GB SSD	None	Intel 7265 ac, 2x2 + BT4.0	WWAN Upgradable	None	None	720p	Backlit	Fingerprint Reader	3-cell(23Wh) + 3-cell(23Wh)	45W	Win10 Pro 64	3-year, Onsite	09/15
20CL00BMUS	US	i5-5300U	vPro	Intel HD 5500	4GBx1	12.5" HD (1366x768) IPS	None	500GB 7200rpm	16GB SSD	None	Intel 7265 ac, 2x2 + BT4.0	WWAN Upgradable	None	None	720p	Backlit	Fingerprint Reader	3-cell(23Wh) + 3-cell(23Wh)	45W	Win10 Pro 64	3-year, Onsite	09/15
20CL00BNUS	US	i7-5600U	vPro	Intel HD 5500	8GBx1	12.5" HD (1366x768) IPS	None	500GB 7200rpm	16GB SSD	None	Intel 7265 ac, 2x2 + BT4.0	WWAN Upgradable	None	None	720p	Backlit	Fingerprint Reader	3-cell(23Wh) + 3-cell(23Wh)	45W	Win10 Pro 64	3-year, Onsite	09/15
20CL00BPUS	US	i5-5200U	No	Intel HD 5500	4GBx1	12.5" HD (1366x768) IPS	None	500GB 7200rpm	16GB SSD	None	Intel 7265 ac, 2x2 + BT4.0	WWAN Upgradable	None	None	720p	Backlit	Fingerprint Reader	3-cell(23Wh) + 3-cell(23Wh)	45W	Win10 Pro 64	3-year, Onsite	09/15
20CL00BQUS	US	i7-5600U	vPro	Intel HD 5500	16GBx1	12.5" HD (1366x768) IPS	None	256GB SSD Opal2	None	None	Intel 7265 ac, 2x2 + BT4.0	WWAN Upgradable	None	None	720p	Backlit	Fingerprint Reader	3-cell(23Wh) + 3-cell(23Wh)	45W	Win10 Pro 64	3-year, Onsite	09/15
20CL00BRUS	US	i5-5300U	vPro	Intel HD 5500	8GBx1	12.5" HD (1366x768) IPS	None	500GB 7200rpm	16GB SSD	None	Intel 7265 ac, 2x2 + BT4.0	WWAN Upgradable	None	None	720p	Backlit	Fingerprint Reader	3-cell(23Wh) + 3-cell(23Wh)	45W	Win10 Pro 64	3-year, Onsite	09/15
20CL00BSUS	US	i7-5600U	vPro	Intel HD 5500	8GBx1	12.5" FHD (1920x1080) IPS	10-point Multi-touch	256GB SSD Opal2	None	None	Intel 7265 ac, 2x2 + BT4.0	WWAN Upgradable	None	None	720p	Backlit	Fingerprint Reader	3-cell(23Wh) + 3-cell(23Wh)	45W	Win10 Pro 64	3-year, Onsite	09/15
20CL00BTUS	US	i5-5300U	vPro	Intel HD 5500	8GBx1	12.5" HD (1366x768) IPS	None	256GB SSD Opal2	None	None	Intel 7265 ac, 2x2 + BT4.0	WWAN Upgradable	None	None	720p	Backlit	Fingerprint Reader	3-cell(23Wh) + 3-cell(23Wh)	45W	Win10 Pro 64	3-year, Onsite	09/15
20CL00BUUS	US	i5-5300U	vPro	Intel HD 5500	8GBx1	12.5" FHD (1920x1080) IPS	10-point Multi-touch	500GB 7200rpm	16GB SSD	None	Intel 7265 ac, 2x2 + BT4.0	WWAN Upgradable	None	None	720p	Backlit	Fingerprint Reader	3-cell(23Wh) + 3-cell(23Wh)	45W	Win10 Pro 64	3-year, Onsite	09/15
20CL00BVUS	US	i7-5600U	vPro	Intel HD 5500	16GBx1	12.5" FHD (1920x1080) IPS	10-point Multi-touch	256GB SSD Opal2	None	None	Intel 7265 ac, 2x2 + BT4.0	WWAN Upgradable	None	None	720p	Backlit	Fingerprint Reader	3-cell(23Wh) + 3-cell(23Wh)	45W	Win10 Pro 64	3-year, Onsite	09/15

Model	Region	Processor	vPro	Graphics	Memory	Display	Multi-touch	Storage	M.2 SSD	Optical	WLAN + Bluetooth	WWAN	SIM Card	Smart Card Reader	Camera	Keyboard	Fingerprint Reader	Battery (internal+external)	Power Adapter	Operating System	Warranty	Ann Date (m/y)
20CL00BWUS	US	i7-5600U	vPro	Intel HD 5500	4GBx1	12.5" HD (1366x768) IPS	None	500GB 7200rpm	16GB SSD	None	Intel 7265 ac, 2x2 + BT4.0	WWAN Upgradable	None	None	720p	Backlit	Fingerprint Reader	3-cell(23Wh) + 3-cell(23Wh)	45W	Win10 Pro 64	3-year, Onsite	09/15
20CL00BXUS	US	i5-4300U	vPro	Intel HD 5500	4GBx1	12.5" HD (1366x768) IPS	None	500GB 7200rpm	16GB SSD	None	Intel 7265 ac, 2x2 + BT4.0	WWAN Upgradable	None	None	720p	Backlit	Fingerprint Reader	3-cell(23Wh) + 3-cell(23Wh)	45W	Win10 Pro 64	3-year, Onsite	09/15



ThinkPad X260 Platform Specifications

Product Specifications Reference (PSREF)

Processor	6th Generation Intel® Core™ i3 / i5 / i7 Processor								Smart card reader	Optional: Smart card reader										
	Processor Number	# of Cores	# of Threads	Base Frequency	Max Turbo Frequency	Cache	Memory Types	Processor Graphics	Media reader	4-in-1 reader (MMC, SD, SDHC, SDXC)										
	i3-6006U	2	4	2.0 GHz	-	3MB	DDR4-2133	Intel HD graphics 520	Ports	Three USB 3.0 (one Always On), HDMI, MiniDP, Ethernet (RJ-45), Dock connector										
	i3-6100U			2.3 GHz	-	3MB			WiGig dock	None										
	i5-6200U			2.3 GHz	2.8 GHz	3MB			Monitor cable	Optional: HDMI to VGA Monitor Cable or Mini DisplayPort to VGA Monitor Cable										
	i5-6300U			2.4 GHz	3.0 GHz	3MB			Camera (optional)	HD720p resolution, low light sensitive, fixed focus										
	i7-6500U			2.5 GHz	3.1 GHz	4MB			Audio support	HD Audio, Realtek® ALC3245 codec / stereo speakers, 1W x 2 / dual array microphone, combo audio/microphone jack										
	i7-6600U			2.6 GHz	3.4 GHz	4MB			Keyboard	6-row, spill-resistant, multimedia Fn keys, optional LED backlight										
									UltraNav™	TrackPoint® pointing device and buttonless Mylar surface touchpad, multi-touch										
Graphics	Intel HD Graphics 520 in processor, supports external digital monitor via HDMI or Mini DisplayPort; supports three independent displays; Max resolution: 4096x2304@60Hz (DisplayPort via Mini DisplayPort cable); 4096x2160@24Hz (HDMI)								Security	Power-on password, hard disk password, supervisor password, security keyhole										
Chipset	Intel SoC (System on Chip) platform								Security chip	Discrete TPM 1.2 TCG Certified and Firmware TPM 2.0 integrated in chipset										
Memory	16GB max / 2133MHz DDR4, one DDR4 SO-DIMM socket								ThinkEngine	Delivers improved thermal and power efficiency, up to 30 day standby, faster resume time, enhanced security, as well as anti-tampering measures										
Display	<i>Some:</i> 12.5" (317.5mm) HD (1366x768), anti-glare, LED backlight, 200 nits, 16:9 aspect ratio, 300:1 contrast ratio <i>Some:</i> 12.5" (317.5mm) HD (1366x768), anti-glare, LED backlight, IPS, 300 nits, 16:9 aspect ratio, 700:1 contrast ratio, 170° viewing angle <i>Some:</i> 12.5" (317.5mm) FHD (1920x1080), anti-glare, LED backlight, IPS, 300 nits, 16:9 aspect ratio, 700:1 contrast ratio, 170° viewing angle								vPro (optional)	Intel vPro Technology										
									Fingerprint reader	Optional: Swipe style fingerprint reader on the keyboard bezel										
Multi-touch	None								Internal battery	Optional: Integrated Li-Ion or Li-Polymer 3-cell (23Wh)										
Storage	<i>Some:</i> SSD / SATA 6.0Gb/s (e.g. xxxG SSD) <i>Some:</i> SSD / PCIe NVMe, PCIe 3.0 x 2, 16Gb/s (e.g. xxxG SSD PCIe NVMe) <i>Some:</i> HDD / SATA 6.0Gb/s, 2.5" wide, 7mm or 9.5mm high, Shock Mounted Hard Drive, Active Protection System™ <i>Some:</i> SSHD with 8GB NAND flash memory								External battery	Li-Ion 3-cell (23Wh) or 6-cell (48Wh or 72Wh)										
Optical	None								Max battery life ¹⁰ (MobileMark® 2014)	<table border="1"> <thead> <tr> <th>Models</th> <th>No + 3-cell</th> <th>3-cell + 3-cell</th> <th>3-cell + 6-cell 48Wh</th> <th>3-cell + 6-cell 72Wh</th> </tr> </thead> <tbody> <tr> <td>Max battery life</td> <td>6 hr</td> <td>12 hr</td> <td>18.5 hr</td> <td>25 hr</td> </tr> </tbody> </table>	Models	No + 3-cell	3-cell + 3-cell	3-cell + 6-cell 48Wh	3-cell + 6-cell 72Wh	Max battery life	6 hr	12 hr	18.5 hr	25 hr
Models	No + 3-cell	3-cell + 3-cell	3-cell + 6-cell 48Wh	3-cell + 6-cell 72Wh																
Max battery life	6 hr	12 hr	18.5 hr	25 hr																
Ethernet	<i>Non-vPro model:</i> Intel Ethernet Connection I219-V (Jacksonville) <i>vPro model:</i> Intel Ethernet Connection I219-LM (Jacksonville)								AC adapter	45W AC adapter										
WLAN ⁴	<i>One of the following, configurable by model:</i> • 11ac+BT, Broadcom BCM4356, 2x2, M.2 card • 11ac+BT, Intel Dual Band Wireless-AC 8260, 2x2, M.2 card								Preload	Windows® 7 Professional 64 preinstalled through downgrade rights in Windows 10 Pro 64 <ul style="list-style-type: none"> • Lenovo Solution Center • Lenovo SHAREit • Lenovo Companion • Lenovo Setting • ThinkVantage Product Recovery • Microsoft Office preloaded; purchase a product key to activate • Rescue and Recovery™ • McAfee® LiveSafe™ (30-day trial) • ThinkVantage System Update • Adobe® Reader® • Microsoft® Office preloaded; purchase a product key to activate • McAfee® LiveSafe™ (30-day trial) 										
Bluetooth™	Bluetooth 4.1 wireless, integrated in Wi-Fi + Bluetooth combo adapter								Limited warranty ¹²	<i>One of the following, configurable by model:</i> • 1-year depot repair service • 3-year/1-yr battery depot repair service • 3-year/1-yr battery limited onsite service ²⁴ • 3-year/1-yr battery limited onsite service, OID (Onsite International Delivery)										
WWAN (optional)	<i>One of the following, configurable by model (mutually exclusive with WiGig):</i> • Wireless WAN upgradable • Wireless WAN, Sierra Wireless EM7455, Qualcomm® 4G LTE-Advanced/DC-HSPA+/HSPA+/HSPA/UMTS/GNSS, M.2 card • Wireless WAN, HUAWEI ME906S, HUAWEI 4G LTE/WCDMA/HSPA/GSM/GPRS/EDGE/GNSS, M.2 card (WE only)								Mil-Spec test	MIL-STD-810G military certification										
SIM card (opt)	Micro-SIM card slot, optional Verizon LTE (US) or Lenovo Connect (WE) SIM card								Environment	EPPEAT™ Gold (US only); ENERGY STAR® 6.1; GREENGUARD®; RoHS-compliant										
Dimensions ³	WxDxH: 12.03" x 8.21" x 0.80"; 305.5mm x 208.5mm x 20.3mm																			
Weight ²	<table border="1"> <thead> <tr> <th>Models</th> <th>No + 3-cell</th> <th>3-cell + 3-cell</th> <th>3 + 6-cell 48Wh</th> <th>3-cell + 6-cell 72Wh</th> </tr> </thead> <tbody> <tr> <td>Weight</td> <td>2.94 lb / 1.34 kg</td> <td>3.18 lb / 1.44 kg</td> <td>3.51 lb / 1.59 kg</td> <td>3.58 lb / 1.62 kg</td> </tr> </tbody> </table>								Models	No + 3-cell	3-cell + 3-cell	3 + 6-cell 48Wh	3-cell + 6-cell 72Wh	Weight	2.94 lb / 1.34 kg	3.18 lb / 1.44 kg	3.51 lb / 1.59 kg	3.58 lb / 1.62 kg		
Models	No + 3-cell	3-cell + 3-cell	3 + 6-cell 48Wh	3-cell + 6-cell 72Wh																
Weight	2.94 lb / 1.34 kg	3.18 lb / 1.44 kg	3.51 lb / 1.59 kg	3.58 lb / 1.62 kg																
Case material	Glass-Fiber Reinforced Plastic																			

Model	Region	Processor	vPro	Graphics	Memory	Display	Multi-touch	Storage(HDD/SSD)	Optical	WLAN + Bluetooth	WWAN	SIM Card	Smart Card Reader	Camera	Keyboard	Fingerprint Reader	Battery (internal+ external)	Power Adapter	Operating System	Warranty	Ann Date (m/y)
20F6005EUS	US	i5-6200U	No	Intel HD 520	4GBx1	12.5" HD (1366x768)	None	500GB 7200rpm	None	Intel 8260 ac, 2x2 + BT4.1	WWAN Upgradable	None	None	720p	Backlit	Fingerprint Reader	3-cell(23Wh) + 3-cell(23Wh)	45W	Win10 DG Win7 Pro 64	3-year, Depot	01/16
20F6005FUS	US	i3-6100U	No	Intel HD 520	4GBx1	12.5" HD (1366x768) IPS	None	500GB 7200rpm	None	Intel 8260 ac, 2x2 + BT4.1	WWAN Upgradable	None	None	720p	Backlit	Fingerprint Reader	3-cell(23Wh) + 3-cell(23Wh)	45W	Win10 DG Win7 Pro 64	3-year, Depot	01/16
20F6005GUS	US	i5-6300U	vPro	Intel HD 520	8GBx1	12.5" HD (1366x768)	None	256GB SSD Opal2	None	Intel 8260 ac, 2x2 + BT4.1	WWAN Upgradable	None	None	720p	Backlit	Fingerprint Reader	3-cell(23Wh) + 3-cell(23Wh)	45W	Win10 DG Win7 Pro 64	3-year, Depot	01/16
20F6005HUS	US	i5-6200U	No	Intel HD 520	8GBx1	12.5" HD (1366x768)	None	500GB 7200rpm	None	Intel 8260 ac, 2x2 + BT4.1	WWAN Upgradable	None	None	720p	Backlit	Fingerprint Reader	3-cell(23Wh) + 3-cell(23Wh)	45W	Win10 DG Win7 Pro 64	3-year, Depot	01/16
20F6005JUS	US	i7-6600U	vPro	Intel HD 520	8GBx1	12.5" HD (1366x768)	None	512GB SSD	None	Intel 8260 ac, 2x2 + BT4.1	WWAN Upgradable	None	None	720p	Backlit	Fingerprint Reader	3-cell(23Wh) + 3-cell(23Wh)	45W	Win10 DG Win7 Pro 64	3-year, Depot	01/16
20F6005KUS	US	i7-6600U	vPro	Intel HD 520	8GBx1	12.5" HD (1366x768)	None	192GB SSD	None	Intel 8260 ac, 2x2 + BT4.1	WWAN Upgradable	None	None	720p	Backlit	Fingerprint Reader	3-cell(23Wh) + 3-cell(23Wh)	45W	Win10 DG Win7 Pro 64	3-year, Depot	01/16
20F6005LUS	US	i5-6300U	vPro	Intel HD 520	8GBx1	12.5" HD (1366x768)	None	128GB SSD	None	Intel 8260 ac, 2x2 + BT4.1	WWAN Upgradable	None	None	720p	Backlit	Fingerprint Reader	3-cell(23Wh) + 3-cell(23Wh)	45W	Win10 DG Win7 Pro 64	3-year, Depot	01/16
20F6005MUS	US	i7-6600U	vPro	Intel HD 520	16GBx1	12.5" HD (1366x768)	None	512GB SSD	None	Intel 8260 ac, 2x2 + BT4.1	WWAN Upgradable	None	None	720p	Backlit	Fingerprint Reader	3-cell(23Wh) + 3-cell(23Wh)	45W	Win10 DG Win7 Pro 64	3-year, Depot	01/16
20F6005NUS	US	i5-6300U	vPro	Intel HD 520	8GBx1	12.5" HD (1366x768)	None	192GB SSD	None	Intel 8260 ac, 2x2 + BT4.1	WWAN Upgradable	None	None	720p	Backlit	Fingerprint Reader	3-cell(23Wh) + 3-cell(23Wh)	45W	Win10 DG Win7 Pro 64	3-year, Depot	01/16
20F6005QUS	US	i3-6100U	No	Intel HD 520	4GBx1	12.5" HD (1366x768)	None	500GB 7200rpm	None	Intel 8260 ac, 2x2 + BT4.1	WWAN Upgradable	None	None	720p	Backlit	Fingerprint Reader	3-cell(23Wh) + 3-cell(23Wh)	45W	Win10 DG Win7 Pro 64	3-year, Depot	01/16
20F6005RUS	US	i7-6600U	vPro	Intel HD 520	8GBx1	12.5" HD (1366x768)	None	256GB SSD Opal2	None	Intel 8260 ac, 2x2 + BT4.1	WWAN Upgradable	None	None	720p	Backlit	Fingerprint Reader	3-cell(23Wh) + 3-cell(23Wh)	45W	Win10 DG Win7 Pro 64	3-year, Depot	01/16
20F6005SUS	US	i5-6300U	vPro	Intel HD 520	8GBx1	12.5" HD (1366x768)	None	500GB 7200rpm	None	Intel 8260 ac, 2x2 + BT4.1	WWAN Upgradable	None	None	720p	Backlit	Fingerprint Reader	3-cell(23Wh) + 3-cell(23Wh)	45W	Win10 DG Win7 Pro 64	3-year, Depot	01/16
20F60068US	US	i5-6200U	No	Intel HD 520	8GBx1	12.5" HD (1366x768) IPS	None	128GB SSD	None	Intel 8260 ac, 2x2 + BT4.1	WWAN Upgradable	None	None	720p	Backlit	Fingerprint Reader	3-cell(23Wh) + 3-cell(23Wh)	45W	Win10 Pro 64	3-year, Depot	03/16
20F60069US	US	i5-6300U	No	Intel HD 520	8GBx1	12.5" HD (1366x768) IPS	None	128GB SSD	None	Intel 8260 ac, 2x2 + BT4.1	WWAN Upgradable	None	None	720p	Backlit	Fingerprint Reader	3-cell(23Wh) + 3-cell(23Wh)	45W	Win10 Pro 64	3-year, Depot	03/16
20F6006AUS	US	i5-6300U	No	Intel HD 520	8GBx1	12.5" HD (1366x768) IPS	None	256GB SSD Opal2	None	Intel 8260 ac, 2x2 + BT4.1	WWAN Upgradable	None	None	720p	Backlit	Fingerprint Reader	3-cell(23Wh) + 3-cell(23Wh)	45W	Win10 Pro 64	3-year, Depot	03/16
20F6006BUS	US	i5-6200U	No	Intel HD 520	8GBx1	12.5" HD (1366x768) IPS	None	500GB SSHD 5400rpm	None	Intel 8260 ac, 2x2 + BT4.1	WWAN Upgradable	None	None	720p	Backlit	Fingerprint Reader	3-cell(23Wh) + 3-cell(23Wh)	45W	Win10 Pro 64	3-year, Depot	03/16
20F6006CUS	US	i5-6300U	No	Intel HD 520	8GBx1	12.5" HD (1366x768)	None	500GB SSHD 5400rpm	None	Intel 8260 ac, 2x2 + BT4.1	WWAN Upgradable	None	None	720p	Backlit	Fingerprint Reader	3-cell(23Wh) + 3-cell(23Wh)	45W	Win10 Pro 64	3-year, Depot	03/16
20F6006DUS	US	i5-6200U	No	Intel HD 520	8GBx1	12.5" HD (1366x768)	None	500GB SSHD 5400rpm	None	Intel 8260 ac, 2x2 + BT4.1	WWAN Upgradable	None	None	720p	Backlit	Fingerprint Reader	3-cell(23Wh) + 3-cell(23Wh)	45W	Win10 Pro 64	3-year, Depot	03/16
20F6006EUS	US	i5-6300U	No	Intel HD 520	8GBx1	12.5" HD (1366x768) IPS	None	500GB SSHD 5400rpm	None	Intel 8260 ac, 2x2 + BT4.1	WWAN Upgradable	None	None	720p	Backlit	Fingerprint Reader	3-cell(23Wh) + 3-cell(23Wh)	45W	Win10 Pro 64	3-year, Depot	03/16
20F6006FUS	US	i5-6200U	No	Intel HD 520	8GBx1	12.5" HD (1366x768)	None	256GB SSD Opal2	None	Intel 8260 ac, 2x2 + BT4.1	WWAN Upgradable	None	None	720p	Backlit	Fingerprint Reader	3-cell(23Wh) + 3-cell(23Wh)	45W	Win10 DG Win7 Pro 64	3-year, Depot	03/16

ThinkPad X260 - TopSeller - 20F6 - 2 of 4

Product Specifications Reference (PSREF)

Model	Region	Processor	vPro	Graphics	Memory	Display	Multi-touch	Storage(HDD/SSD)	Optical	WLAN + Bluetooth	WWAN	SIM Card	Smart Card Reader	Camera	Keyboard	Fingerprint Reader	Battery (internal+external)	Power Adapter	Operating System	Warranty	Ann Date (m/y)
20F6006GUS	US	i7-6600U	vPro	Intel HD 520	16GBx1	12.5" HD (1366x768) IPS	None	512GB SSD	None	Intel 8260 ac, 2x2 + BT4.1	WWAN Upgradable	None	None	720p	Backlit	Fingerprint Reader	3-cell(23Wh) + 3-cell(23Wh)	45W	Win10 DG Win7 Pro 64	3-year, Depot	03/16
20F6006HUS	US	i5-6300U	vPro	Intel HD 520	8GBx1	12.5" HD (1366x768)	None	180GB SSD Opal2	None	Intel 8260 ac, 2x2 + BT4.1	WWAN Upgradable	None	None	720p	Backlit	Fingerprint Reader	3-cell(23Wh) + 3-cell(23Wh)	45W	Win10 DG Win7 Pro 64	3-year, Depot	03/16
20F6006JUS	US	i7-6600U	vPro	Intel HD 520	16GBx1	12.5" HD (1366x768)	None	192GB SSD	None	Intel 8260 ac, 2x2 + BT4.1	WWAN Upgradable	None	None	720p	Backlit	Fingerprint Reader	3-cell(23Wh) + 3-cell(23Wh)	45W	Win10 DG Win7 Pro 64	3-year, Depot	03/16
20F6006KUS	US	i7-6600U	vPro	Intel HD 520	16GBx1	12.5" HD (1366x768)	None	256GB SSD Opal2	None	Intel 8260 ac, 2x2 + BT4.1	WWAN Upgradable	None	None	720p	Backlit	Fingerprint Reader	3-cell(23Wh) + 3-cell(23Wh)	45W	Win10 DG Win7 Pro 64	3-year, Depot	03/16
20F6006LUS	US	i7-6600U	vPro	Intel HD 520	16GBx1	12.5" HD (1366x768) IPS	None	256GB SSD Opal2	None	Intel 8260 ac, 2x2 + BT4.1	WWAN Upgradable	None	None	720p	Backlit	Fingerprint Reader	3-cell(23Wh) + 3-cell(23Wh)	45W	Win10 DG Win7 Pro 64	3-year, Depot	03/16
20F6006NUS	US	i7-6600U	vPro	Intel HD 520	16GBx1	12.5" HD (1366x768) IPS	None	192GB SSD	None	Intel 8260 ac, 2x2 + BT4.1	WWAN Upgradable	None	None	720p	Backlit	Fingerprint Reader	3-cell(23Wh) + 3-cell(23Wh)	45W	Win10 DG Win7 Pro 64	3-year, Depot	03/16
20F6006PUS	US	i7-6600U	vPro	Intel HD 520	16GBx1	12.5" HD (1366x768)	None	180GB SSD Opal2	None	Intel 8260 ac, 2x2 + BT4.1	WWAN Upgradable	None	None	720p	Backlit	Fingerprint Reader	3-cell(23Wh) + 3-cell(23Wh)	45W	Win10 DG Win7 Pro 64	3-year, Depot	03/16
20F6006QUS	US	i5-6200U	No	Intel HD 520	8GBx1	12.5" HD (1366x768)	None	128GB SSD	None	Intel 8260 ac, 2x2 + BT4.1	WWAN Upgradable	None	None	720p	Backlit	Fingerprint Reader	3-cell(23Wh) + 3-cell(23Wh)	45W	Win10 DG Win7 Pro 64	3-year, Depot	03/16
20F6006RUS	US	i5-6300U	vPro	Intel HD 520	4GBx1	12.5" HD (1366x768)	None	500GB 7200rpm	None	Intel 8260 ac, 2x2 + BT4.1	WWAN Upgradable	None	None	720p	Backlit	Fingerprint Reader	3-cell(23Wh) + 3-cell(23Wh)	45W	Win10 DG Win7 Pro 64	3-year, Depot	03/16
20F6006SUS	US	i7-6600U	vPro	Intel HD 520	8GBx1	12.5" HD (1366x768) IPS	None	500GB 7200rpm	None	Intel 8260 ac, 2x2 + BT4.1	WWAN Upgradable	None	None	720p	Backlit	Fingerprint Reader	3-cell(23Wh) + 6-cell(48Wh)	45W	Win10 DG Win7 Pro 64	3-year, Depot	03/16
20F6006TUS	US	i7-6600U	vPro	Intel HD 520	16GBx1	12.5" HD (1366x768) IPS	None	500GB 7200rpm	None	Intel 8260 ac, 2x2 + BT4.1	WWAN Upgradable	None	None	720p	Backlit	Fingerprint Reader	3-cell(23Wh) + 3-cell(23Wh)	45W	Win10 DG Win7 Pro 64	3-year, Depot	03/16
20F6008GUS	US	i7-6600U	vPro	Intel HD 520	8GBx1	12.5" HD (1366x768) IPS	None	128GB SSD	None	Intel 8260 ac, 2x2 + BT4.1	WWAN Upgradable	None	None	720p	Non-backlit	Fingerprint Reader	3-cell(23Wh) + 3-cell(23Wh)	45W	Win10 DG Win7 Pro 64	3-year, Depot	04/16
20F6008HUS	US	i5-6200U	No	Intel HD 520	8GBx1	12.5" HD (1366x768) IPS	None	128GB SSD	None	Intel 8260 ac, 2x2 + BT4.1	WWAN Upgradable	None	None	720p	Non-backlit	Fingerprint Reader	3-cell(23Wh) + 3-cell(23Wh)	45W	Win10 DG Win7 Pro 64	3-year, Depot	04/16
20F6008JUS	US	i7-6500U	No	Intel HD 520	8GBx1	12.5" HD (1366x768) IPS	None	128GB SSD	None	Intel 8260 ac, 2x2 + BT4.1	WWAN Upgradable	None	None	720p	Non-backlit	Fingerprint Reader	3-cell(23Wh) + 3-cell(23Wh)	45W	Win10 DG Win7 Pro 64	3-year, Depot	04/16
20F6008KUS	US	i7-6500U	No	Intel HD 520	8GBx1	12.5" FHD (1920x1080) IPS	None	500GB 7200rpm	None	Intel 8260 ac, 2x2 + BT4.1	WWAN Upgradable	None	None	720p	Non-backlit	Fingerprint Reader	3-cell(23Wh) + 3-cell(23Wh)	45W	Win10 DG Win7 Pro 64	3-year, Depot	04/16
20F6008LUS	US	i7-6600U	vPro	Intel HD 520	8GBx1	12.5" FHD (1920x1080) IPS	None	256GB SSD PCIe NVMe Opal2	None	Intel 8260 ac, 2x2 + BT4.1	WWAN Upgradable	None	None	720p	Non-backlit	Fingerprint Reader	3-cell(23Wh) + 3-cell(23Wh)	45W	Win10 DG Win7 Pro 64	3-year, Depot	05/16
20F6008MUS	US	i7-6500U	No	Intel HD 520	8GBx1	12.5" FHD (1920x1080) IPS	None	256GB SSD Opal2	None	Intel 8260 ac, 2x2 + BT4.1	WWAN Upgradable	None	None	720p	Non-backlit	Fingerprint Reader	3-cell(23Wh) + 3-cell(23Wh)	45W	Win10 DG Win7 Pro 64	3-year, Depot	04/16
20F6008NUS	US	i5-6200U	No	Intel HD 520	8GBx1	12.5" HD (1366x768) IPS	None	256GB SSD Opal2	None	Intel 8260 ac, 2x2 + BT4.1	WWAN Upgradable	None	None	720p	Non-backlit	Fingerprint Reader	3-cell(23Wh) + 3-cell(23Wh)	45W	Win10 DG Win7 Pro 64	3-year, Depot	04/16
20F6008PUS	US	i5-6300U	vPro	Intel HD 520	8GBx1	12.5" HD (1366x768) IPS	None	128GB SSD	None	Intel 8260 ac, 2x2 + BT4.1	WWAN Upgradable	None	None	720p	Non-backlit	Fingerprint Reader	3-cell(23Wh) + 3-cell(23Wh)	45W	Win10 DG Win7 Pro 64	3-year, Depot	04/16
20F6008QUS	US	i3-6100U	No	Intel HD 520	8GBx1	12.5" HD (1366x768) IPS	None	128GB SSD	None	Intel 8260 ac, 2x2 + BT4.1	WWAN Upgradable	None	None	720p	Non-backlit	Fingerprint Reader	3-cell(23Wh) + 3-cell(23Wh)	45W	Win10 DG Win7 Pro 64	3-year, Depot	04/16

Model	Region	Processor	vPro	Graphics	Memory	Display	Multi-touch	Storage(HDD/SSD)	Optical	WLAN + Bluetooth	WWAN	SIM Card	Smart Card Reader	Camera	Keyboard	Fingerprint Reader	Battery (Internal+external)	Power Adapter	Operating System	Warranty	Ann Date (m/y)
20F6008RUS	US	i3-6100U	No	Intel HD 520	8GBx1	12.5" HD (1366x768) IPS	None	128GB SSD	None	Intel 8260 ac, 2x2 + BT4.1	WWAN Upgradable	None	None	720p	Non-backlit	Fingerprint Reader	3-cell(23Wh) + 3-cell(23Wh)	45W	Win10 DG Win7 Pro 64	3-year, Depot	04/16
20F6008SUS	US	i3-6100U	No	Intel HD 520	8GBx1	12.5" HD (1366x768) IPS	None	500GB 7200rpm	None	Intel 8260 ac, 2x2 + BT4.1	WWAN Upgradable	None	None	720p	Non-backlit	Fingerprint Reader	3-cell(23Wh) + 3-cell(23Wh)	45W	Win10 DG Win7 Pro 64	3-year, Depot	04/16
20F6008TUS	US	i7-6500U	No	Intel HD 520	8GBx1	12.5" HD (1366x768) IPS	None	256GB SSD Opal2	None	Intel 8260 ac, 2x2 + BT4.1	WWAN Upgradable	None	None	720p	Non-backlit	Fingerprint Reader	3-cell(23Wh) + 3-cell(23Wh)	45W	Win10 DG Win7 Pro 64	3-year, Depot	04/16
20F6008UUS	US	i5-6300U	vPro	Intel HD 520	8GBx1	12.5" HD (1366x768) IPS	None	256GB SSD Opal2	None	Intel 8260 ac, 2x2 + BT4.1	WWAN Upgradable	None	None	720p	Non-backlit	Fingerprint Reader	3-cell(23Wh) + 3-cell(23Wh)	45W	Win10 DG Win7 Pro 64	3-year, Depot	04/16
20F6008VUS	US	i7-6500U	No	Intel HD 520	8GBx1	12.5" HD (1366x768) IPS	None	500GB 7200rpm	None	Intel 8260 ac, 2x2 + BT4.1	WWAN Upgradable	None	None	720p	Non-backlit	Fingerprint Reader	3-cell(23Wh) + 3-cell(23Wh)	45W	Win10 DG Win7 Pro 64	3-year, Depot	04/16
20F6008WUS	US	i5-6200U	No	Intel HD 520	8GBx1	12.5" HD (1366x768) IPS	None	128GB SSD	None	Intel 8260 ac, 2x2 + BT4.1	WWAN Upgradable	None	None	720p	Non-backlit	Fingerprint Reader	3-cell(23Wh) + 3-cell(23Wh)	45W	Win10 DG Win7 Pro 64	3-year, Depot	04/16
20F6008XUS	US	i7-6600U	vPro	Intel HD 520	16GBx1	12.5" FHD (1920x1080) IPS	None	256GB SSD PCIe NVMe Opal2	None	Intel 8260 ac, 2x2 + BT4.1	WWAN Upgradable	None	None	720p	Non-backlit	Fingerprint Reader	3-cell(23Wh) + 3-cell(23Wh)	45W	Win10 DG Win7 Pro 64	3-year, Depot	05/16
20F60092US	US	i5-6300U	vPro	Intel HD 520	8GBx1	12.5" FHD (1920x1080) IPS	None	180GB SSD Opal2	None	Intel 8260 ac, 2x2 + BT4.1	WWAN Upgradable	None	None	720p	Backlit	Fingerprint Reader	3-cell(23Wh) + 3-cell(23Wh)	45W	Win10 DG Win7 Pro 64	3-year, Depot	05/16
20F60093US	US	i5-6300U	vPro	Intel HD 520	8GBx1	12.5" FHD (1920x1080) IPS	None	256GB SSD Opal2	None	Intel 8260 ac, 2x2 + BT4.1	WWAN Upgradable	None	None	720p	Backlit	Fingerprint Reader	3-cell(23Wh) + 3-cell(23Wh)	45W	Win10 DG Win7 Pro 64	3-year, Depot	05/16
20F60094US	US	i5-6300U	vPro	Intel HD 520	8GBx1	12.5" FHD (1920x1080) IPS	None	500GB 7200rpm	None	Intel 8260 ac, 2x2 + BT4.1	WWAN Upgradable	None	None	720p	Backlit	Fingerprint Reader	3-cell(23Wh) + 3-cell(23Wh)	45W	Win10 DG Win7 Pro 64	3-year, Depot	05/16
20F60095US	US	i5-6200U	No	Intel HD 520	8GBx1	12.5" FHD (1920x1080) IPS	None	256GB SSD Opal2	None	Intel 8260 ac, 2x2 + BT4.1	WWAN Upgradable	None	None	720p	Backlit	Fingerprint Reader	3-cell(23Wh) + 3-cell(23Wh)	45W	Win10 DG Win7 Pro 64	3-year, Depot	05/16
20F60096US	US	i7-6600U	vPro	Intel HD 520	8GBx1	12.5" FHD (1920x1080) IPS	None	256GB SSD Opal2	None	Intel 8260 ac, 2x2 + BT4.1	WWAN Upgradable	None	None	720p	Backlit	Fingerprint Reader	3-cell(23Wh) + 3-cell(23Wh)	45W	Win10 DG Win7 Pro 64	3-year, Depot	05/16
20F60097US	US	i7-6600U	vPro	Intel HD 520	16GBx1	12.5" FHD (1920x1080) IPS	None	256GB SSD Opal2	None	Intel 8260 ac, 2x2 + BT4.1	WWAN Upgradable	None	None	720p	Backlit	Fingerprint Reader	3-cell(23Wh) + 3-cell(23Wh)	45W	Win10 DG Win7 Pro 64	3-year, Depot	05/16
20F60098US	US	i5-6300U	vPro	Intel HD 520	8GBx1	12.5" HD (1366x768) IPS	None	180GB SSD Opal2	None	Intel 8260 ac, 2x2 + BT4.1	WWAN Upgradable	None	None	720p	Backlit	Fingerprint Reader	3-cell(23Wh) + 3-cell(23Wh)	45W	Win10 DG Win7 Pro 64	3-year, Depot	05/16
20F60099US	US	i7-6600U	vPro	Intel HD 520	8GBx1	12.5" HD (1366x768) IPS	None	256GB SSD Opal2	None	Intel 8260 ac, 2x2 + BT4.1	WWAN Upgradable	None	None	720p	Backlit	Fingerprint Reader	3-cell(23Wh) + 3-cell(23Wh)	45W	Win10 DG Win7 Pro 64	3-year, Depot	05/16
20F6009AUS	US	i5-6200U	No	Intel HD 520	8GBx1	12.5" HD (1366x768) IPS	None	500GB 7200rpm	None	Intel 8260 ac, 2x2 + BT4.1	WWAN Upgradable	None	None	720p	Backlit	Fingerprint Reader	3-cell(23Wh) + 3-cell(23Wh)	45W	Win10 DG Win7 Pro 64	3-year, Depot	05/16
20F6009BUS	US	i5-6300U	vPro	Intel HD 520	8GBx1	12.5" HD (1366x768) IPS	None	256GB SSD Opal2	None	Intel 8260 ac, 2x2 + BT4.1	WWAN Upgradable	None	None	720p	Backlit	Fingerprint Reader	3-cell(23Wh) + 3-cell(23Wh)	45W	Win10 DG Win7 Pro 64	3-year, Depot	05/16
20F6009CUS	US	i5-6200U	No	Intel HD 520	8GBx1	12.5" HD (1366x768) IPS	None	256GB SSD Opal2	None	Intel 8260 ac, 2x2 + BT4.1	WWAN Upgradable	None	None	720p	Backlit	Fingerprint Reader	3-cell(23Wh) + 3-cell(23Wh)	45W	Win10 DG Win7 Pro 64	3-year, Depot	05/16
20F6009DUS	US	i5-6200U	No	Intel HD 520	8GBx1	12.5" FHD (1920x1080) IPS	None	500GB 7200rpm	None	Intel 8260 ac, 2x2 + BT4.1	WWAN Upgradable	None	None	720p	Backlit	Fingerprint Reader	3-cell(23Wh) + 3-cell(23Wh)	45W	Win10 DG Win7 Pro 64	3-year, Depot	05/16
20F6009EUS	US	i5-6300U	vPro	Intel HD 520	8GBx1	12.5" HD (1366x768) IPS	None	500GB 7200rpm	None	Intel 8260 ac, 2x2 + BT4.1	WWAN Upgradable	None	None	720p	Backlit	Fingerprint Reader	3-cell(23Wh) + 3-cell(23Wh)	45W	Win10 DG Win7 Pro 64	3-year, Depot	05/16

Model	Region	Processor	vPro	Graphics	Memory	Display	Multi-touch	Storage(HDD/SSD)	Optical	WLAN + Bluetooth	WWAN	SIM Card	Smart Card Reader	Camera	Keyboard	Fingerprint Reader	Battery (internal+external)	Power Adapter	Operating System	Warranty	Ann Date (m/y)
20F600A8US	US	i7-6600U	vPro	Intel HD 520	16GBx1	12.5" FHD (1920x1080) IPS	None	256GB SSD Opal2	None	Intel 8260 ac, 2x2 + BT4.1	WWAN Upgradable	None	None	720p	Backlit	Fingerprint Reader	3-cell(23Wh) + 3-cell(23Wh)	45W	Win10 Pro 64	3-year, Depot	10/16
20F600A9US	US	i5-6300U	vPro	Intel HD 520	8GBx1	12.5" FHD (1920x1080) IPS	None	256GB SSD Opal2	None	Intel 8260 ac, 2x2 + BT4.1	WWAN Upgradable	None	None	720p	Backlit	Fingerprint Reader	3-cell(23Wh) + 3-cell(23Wh)	45W	Win10 Pro 64	3-year, Depot	10/16
20F600AAUS	US	i5-6200U	No	Intel HD 520	8GBx1	12.5" HD (1366x768) IPS	None	180GB SSD Opal2	None	Intel 8260 ac, 2x2 + BT4.1	WWAN Upgradable	None	None	720p	Backlit	Fingerprint Reader	3-cell(23Wh) + 3-cell(23Wh)	45W	Win10 Pro 64	3-year, Depot	10/16
20F600ABUS	US	i7-6600U	vPro	Intel HD 520	8GBx1	12.5" FHD (1920x1080) IPS	None	256GB SSD Opal2	None	Intel 8260 ac, 2x2 + BT4.1	WWAN Upgradable	None	None	720p	Backlit	Fingerprint Reader	3-cell(23Wh) + 3-cell(23Wh)	45W	Win10 Pro 64	3-year, Depot	10/16

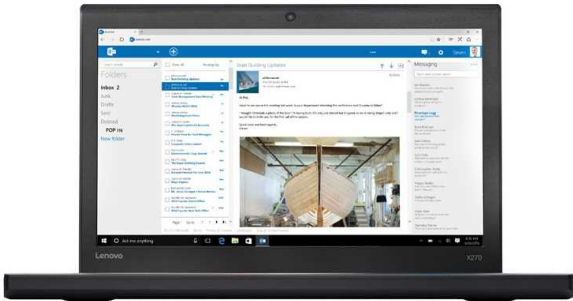

ThinkPad X270 Platform Specifications

Product Specifications Reference (PSREF)

Processor	6th Generation Intel® Core™ i5 / i7 Processor								WWAN (optional) <i>One of the following, configurable by model (mutually exclusive with WiGig):</i>											
	Processor Number	# of Cores	# of Threads	Base Frequency	Max Turbo Frequency	Cache	Memory Types	Processor Graphics	<ul style="list-style-type: none"> • Wireless WAN upgradable • Integrated Mobile Broadband 4G LTE-A, Qualcomm® Snapdragon™ X7 LTE-A (Sierra Wireless EM7455), M.2 card • Integrated Mobile Broadband 4G LTE, Intel XMM™ 7160 (Fibocom L831-EAU), M.2 card (EMEA only) 											
	i5-6200U	2	4	2.3 GHz	2.8 GHz	3MB	DDR4-2133	Intel HD Graphics 520	SIM card (opt) Micro-SIM card slot, opt Verizon LTE (US) or Lenovo® Connect (EMEA) SIM card											
	i5-6300U			2.4 GHz	3.0 GHz	3MB														
	i7-6500U			2.5 GHz	3.1 GHz	4MB														
	i7-6600U			2.6 GHz	3.4 GHz	4MB														
	or 7th Generation Intel Core i3 / i5 / i7 Processor								Dimensions <i>WxDxH:</i> 12.03" x 8.21" x 0.80"; 305.5mm x 208.5mm x 20.3mm											
	Processor Number	# of Cores	# of Threads	Base Frequency	Max Turbo Frequency	Cache	Memory Types	Processor Graphics	Weight											
	i3-7100U	2	4	2.4 GHz	-	3MB	DDR4-2133	Intel HD Graphics 620	<table border="1"> <tr> <td><i>Models</i></td> <td><i>No + 3-cell</i></td> <td><i>3-cell + 3-cell</i></td> <td><i>3 + 6-cell</i></td> </tr> <tr> <td><i>Weight</i></td> <td>2.79 lb / 1.27 kg</td> <td>2.98 lb / 1.36 kg</td> <td>3.33 lb / 1.52 kg</td> </tr> </table>				<i>Models</i>	<i>No + 3-cell</i>	<i>3-cell + 3-cell</i>	<i>3 + 6-cell</i>	<i>Weight</i>	2.79 lb / 1.27 kg	2.98 lb / 1.36 kg	3.33 lb / 1.52 kg
<i>Models</i>	<i>No + 3-cell</i>			<i>3-cell + 3-cell</i>	<i>3 + 6-cell</i>															
<i>Weight</i>	2.79 lb / 1.27 kg			2.98 lb / 1.36 kg	3.33 lb / 1.52 kg															
	i5-7200U			2.5 GHz	3.1 GHz	3MB														
	i5-7300U			2.6 GHz	3.5 GHz	3MB														
	i7-7500U	2.7 GHz	3.5 GHz	4MB																
	i7-7600U	2.8 GHz	3.9 GHz	4MB																
Graphics	Intel HD Graphics 520 or 620 in processor; supports external digital monitor via HDMI or USB Type-C; supports three independent displays; Max resolution: 4096x2160@60Hz (USB Type-C); 4096x2160@24Hz (HDMI)								Case color Black Case material Glass-Fiber Reinforced Plastic											
Chipset	Intel SoC (System on Chip) platform								Smart card reader <i>Optional:</i> Smart card reader											
Memory	16GB max / 2400MHz DDR4, one DDR4 SO-DIMM socket * System clocks down for processors with lower memory controller								Media reader 4-in-1 reader (MMC, SD, SDHC, SDXC)											
Display	<i>Some:</i> 12.5" (317.5mm) HD (1366x768), anti-glare, LED backlight, 200 nits, 16:9 aspect ratio, 500:1 contrast ratio <i>Some:</i> 12.5" (317.5mm) HD (1366x768), anti-glare, LED backlight, IPS, 300 nits, 16:9 aspect ratio, 800:1 contrast ratio, 170° viewing angle <i>Some:</i> 12.5" (317.5mm) FHD (1920x1080), anti-glare, LED backlight, IPS, 300 nits, 16:9 aspect ratio, 700:1 contrast ratio, 170° viewing angle								Ports Two USB 3.1 Gen 1 / USB 3.0 (one Always On), USB 3.1 Type-C Gen 1 / Power Delivery 2.0, HDMI 1.4b, Ethernet (RJ-45), Dock connector											
Multi-touch	None								WiGig dock (opt) ThinkPad WiGig dock, mutually exclusive with WWAN											
Storage	<i>System has one HDD slot or one M.2 2280 slot exclusively for storage</i> <i>Some:</i> HDD / SATA 6.0Gb/s, 2.5" wide, 7mm or 9.5mm high, Active Protection System™ <i>Some:</i> SSD / SATA 6.0Gb/s, 2.5" wide, 7mm high (e.g. xxxGB SSD) <i>Some:</i> M.2 SSD / PCIe NVMe, PCIe 3.0 x 2, 16Gb/s <i>Some:</i> 128GB M.2 SSD / SATA 6.0Gb/s, in WWAN slot as 2nd Storage, mutually exclusive with WiGig <i>Some:</i> 16GB Intel Optane™ memory, PCIe NVMe, PCIe 3.0 x 2, 16Gb/s, in WWAN slot as storage cache for HDD, mutually exclusive with WiGig								Monitor cable (optional) <i>HDMI to VGA:</i> Lenovo HDMI to VGA Monitor Adapter <i>USB-C to VGA:</i> Lenovo USB-C to VGA Adapter <i>USB-C to DP:</i> Lenovo USB-C to DisplayPort Adapter											
Optical	None								Camera (optional) HD720p resolution, fixed focus											
Ethernet	<i>Non-vPro model:</i> Intel Ethernet Connection I219-V (Jacksonville) <i>vPro model:</i> Intel Ethernet Connection I219-LM (Jacksonville)								Audio support HD Audio, Realtek ALC3268 codec / stereo speakers, 1.5W x 2 / dual array microphone, combo audio/microphone jack											
WLAN	<i>One of the following, configurable by model (WiGig is mutually exclusive with WWAN):</i> <ul style="list-style-type: none"> • Realtek® RTL8822BE, Wi-Fi 2x2 802.11ac + BT4.1, M.2 card • Intel Dual Band Wireless-AC 8260, Wi-Fi 2x2 802.11ac + BT4.1, M.2 card • Intel Dual Band Wireless-AC 8265, Wi-Fi 2x2 802.11ac + BT4.1, M.2 card • Intel Tri-Band Wireless-AC 18265, WiGig 802.11ad + Wi-Fi 2x2 802.11ac + BT4.1, M.2 card 								Keyboard 6-row, spill-resistant, multimedia Fn keys, optional LED backlight UltraNav™ TrackPoint® pointing device and buttonless Mylar surface multi-touch touchpad											
Bluetooth™	Bluetooth 4.1 wireless, integrated in Wi-Fi + Bluetooth combo adapter * Intel 8265ac / 18265ac card support BT4.2 but is limited to BT4.1 by Windows OS								Security Power-on password, hard disk password, supervisor password, security keyhole Security chip <i>Win7 model:</i> discrete TPM 1.2, TCG Certified <i>Win10 model:</i> discrete TPM 2.0, TCG Certified											
									vPro (optional) Intel vPro Technology											
									Fingerprint reader <i>Optional:</i> Touch style match on chip fingerprint reader on the palm rest											
									NFC (optional) Near Field Communication											
									Internal battery <i>Optional:</i> Integrated Li-Ion or Li-Polymer 3-cell (23Wh)											
									External battery Li-Ion 3-cell (23Wh) or 6-cell (48Wh or 72Wh)											
									Max battery life <i>MobileMark® 2014:</i> 13.04 hr (3-cell + 3-cell)											
									AC adapter 45W AC adapter (slim tip) or 45W USB Type-C AC adapter											
									Preload Windows® 7 Professional 64 preinstalled through downgrade rights in Windows 10 Pro 64 <i>Some:</i> Windows 10 Home 64 <i>Some:</i> Windows 10 Pro 64 • Lenovo Companion • Lenovo Solution Center • Lenovo PowerEngage • ThinkVantage Product Recovery • ThinkVantage System Update • Adobe® Reader® • Microsoft® Office preloaded; purchase a product key to activate • McAfee® LiveSafe™ (30-day trial)											
									Limited warranty <i>One of the following, configurable by model:</i> • 1-year depot repair service • 3-year/1-yr battery depot repair service • 3-year/1-yr battery limited onsite service											
									Mil-Spec test MIL-STD-810G military certification											
									Environment EPEAT™ Gold (US only); ENERGY STAR® 6.1; RoHS-compliant											

ThinkPad X270 - TopSeller - 20HN

Product Specifications Reference (PSREF)

Model	Region	Processor	vPro	Graphics	Memory	Display	Multi-touch	Storage(HDD/SSD)	Optical	WLAN + Bluetooth	WWAN	SIM Card	Smart Card Reader	Dock	Camera	Key-board	Finger-print Reader	NFC	TPM	Battery (internal+external)	Power Adapter	Operating System	Warranty	Ann Date (m/y)
20HN001FUS	US	i5-7200U	No	Intel HD 620	8GBx1	12.5" FHD (1920x1080) IPS	None	256GB SSD PCIe NVMe Opal2	None	Intel 8265 ac, 2x2 + BT4.1	WWAN Upgradable	None	None	None	720p	Backlit	Finger-print Reader	None	dTPM 2.0	3-cell(23Wh) + 3-cell(23Wh)	45W	Win10 Pro 64	3-year, Depot	02/17
20HN001GUS	US	i7-7600U	vPro	Intel HD 620	16GBx1	12.5" FHD (1920x1080) IPS	None	512GB SSD PCIe NVMe Opal2	None	Intel 8265 ac, 2x2 + BT4.1	WWAN Upgradable	None	None	None	720p	Backlit	Finger-print Reader	None	dTPM 2.0	3-cell(23Wh) + 3-cell(23Wh)	45W	Win10 Pro 64	3-year, Depot	02/17
20HN001HUS	US	i7-7500U	No	Intel HD 620	16GBx1	12.5" FHD (1920x1080) IPS	None	256GB SSD PCIe NVMe Opal2	None	Intel 8265 ac, 2x2 + BT4.1	WWAN Upgradable	None	None	None	720p	Backlit	Finger-print Reader	None	dTPM 2.0	3-cell(23Wh) + 3-cell(23Wh)	45W	Win10 Pro 64	3-year, Depot	02/17
20HN001JUS	US	i5-7300U	vPro	Intel HD 620	8GBx1	12.5" FHD (1920x1080) IPS	None	256GB SSD PCIe NVMe Opal2	None	Intel 8265 ac, 2x2 + BT4.1	WWAN Upgradable	None	None	None	720p	Backlit	Finger-print Reader	None	dTPM 2.0	3-cell(23Wh) + 3-cell(23Wh)	45W	Win10 Pro 64	3-year, Depot	02/17
20HN001KUS	US	i5-7200U	No	Intel HD 620	8GBx1	12.5" HD (1366x768) IPS	None	500GB 7200rpm	None	Intel 8265 ac, 2x2 + BT4.1	WWAN Upgradable	None	None	None	720p	Backlit	Finger-print Reader	None	dTPM 2.0	3-cell(23Wh) + 3-cell(23Wh)	45W	Win10 Pro 64	3-year, Depot	02/17
20HN001LUS	US	i5-7300U	vPro	Intel HD 620	8GBx1	12.5" HD (1366x768) IPS	None	256GB SSD PCIe NVMe Opal2	None	Intel 8265 ac, 2x2 + BT4.1	WWAN Upgradable	None	None	None	720p	Backlit	Finger-print Reader	None	dTPM 2.0	3-cell(23Wh) + 3-cell(23Wh)	45W	Win10 Pro 64	3-year, Depot	02/17
20HN001MUS	US	i7-7500U	No	Intel HD 620	16GBx1	12.5" FHD (1920x1080) IPS	None	512GB SSD PCIe NVMe Opal2	None	Intel 8265 ac, 2x2 + BT4.1	WWAN Upgradable	None	None	None	720p	Backlit	Finger-print Reader	None	dTPM 2.0	3-cell(23Wh) + 3-cell(23Wh)	45W	Win10 Pro 64	3-year, Depot	02/17
20HN001NUS	US	i7-7600U	vPro	Intel HD 620	16GBx1	12.5" FHD (1920x1080) IPS	None	256GB SSD PCIe NVMe Opal2	None	Intel 8265 ac, 2x2 + BT4.1	WWAN Upgradable	None	None	None	720p	Backlit	Finger-print Reader	None	dTPM 2.0	3-cell(23Wh) + 3-cell(23Wh)	45W	Win10 Pro 64	3-year, Depot	02/17
20HN001PUS	US	i3-7100U	No	Intel HD 620	4GBx1	12.5" HD (1366x768) IPS	None	500GB 7200rpm	None	Intel 8265 ac, 2x2 + BT4.1	WWAN Upgradable	None	None	None	720p	Backlit	Finger-print Reader	None	dTPM 2.0	3-cell(23Wh) + 3-cell(23Wh)	45W	Win10 Pro 64	3-year, Depot	02/17
20HN001QUS	US	i7-7600U	vPro	Intel HD 620	8GBx1	12.5" FHD (1920x1080) IPS	None	256GB SSD PCIe NVMe Opal2	None	Intel 8265 ac, 2x2 + BT4.1	WWAN Upgradable	None	None	None	720p	Backlit	Finger-print Reader	None	dTPM 2.0	3-cell(23Wh) + 3-cell(23Wh)	45W	Win10 Pro 64	3-year, Depot	02/17
20HN001RUS	US	i7-7500U	No	Intel HD 620	8GBx1	12.5" FHD (1920x1080) IPS	None	256GB SSD PCIe NVMe Opal2	None	Intel 8265 ac, 2x2 + BT4.1	WWAN Upgradable	None	None	None	720p	Backlit	Finger-print Reader	None	dTPM 2.0	3-cell(23Wh) + 3-cell(23Wh)	45W	Win10 Pro 64	3-year, Depot	02/17

Availability: All offers subject to availability. Lenovo reserves the right to alter product offerings and specifications at any time, without notice. Lenovo is not responsible for photographic or typographic errors.

Warranty: For a copy of applicable product warranties, go to http://support.lenovo.com/en_US/product-service/warranty-status/WarrantyPolicies.page. Lenovo makes no representation or warranty regarding third party products or services.

Footnotes:

- ¹ Power management, including Intel® SpeedStep® Technology, reduces processor speed when in battery mode.
- ² **Weight** includes battery and standard optical drive; weight may vary due to vendor components, manufacturing process and options.
- ³ **Thinness** may vary at certain points on the system.
- ⁴ **Wireless capability:** Requires compatible wireless-enabled options sold separately.
- ⁵ **TAA:** ThinkPad notebook is compliant with the U.S. Federal Government's country-of-origin requirements prescribed in 48 C.F.R. Subpart 25.4; Trade Act Agreement (TAA) model.
- ⁶ **Public network download modem speeds** are limited to 53Kbps. Upload speeds are limited to 48Kbps for V.92 modems. Actual speeds depend on many factors and are often less than the maximum possible. V.92 functions and speeds require compatible phone line and server equipment. Check with your telephone and ISP service providers for availability.
- ⁷ **Maximum memory capacity** may require the replacement of standard component with largest supported component available. On ThinkPad systems, even though it is possible to physically install 4GB of memory, the actual amount of memory addressable by a 32-bit operating system will be limited to 3GB. This limitation does not exist with 64-bit operating systems.
- ⁸ **Hard drive:** GB = billion bytes, TB = trillion bytes. Accessible capacity is less; up to 4GB is service partition.

¹⁰ **Battery:** These model numbers achieved the battery life based on MobileMark® 2012 during testing. Battery life (and recharge times) will vary based on many factors including screen brightness, applications, features, power management, battery conditioning, and other customer preferences.

¹¹ **External monitor:** This system supports a maximum of two external monitors. The integrated display(s) must be disabled to support two external monitors.

¹² **Limited warranty:** Support unrelated to a warranty issue may be subject to additional charges.

¹⁴ **Included software** may differ from its retail version (if available), and may not include user manuals or all program functionality. Software license agreements may apply.

¹⁶ **Activating Verizon Wireless Service:** Lenovo customers will be contacted after purchase to activate service; requires separate agreement with Verizon Wireless and is subject to the Customer Agreement, Calling Plan, and credit approval. Service, airtime, and early termination charges may apply. Verizon Wireless, not Lenovo, is solely responsible for service. Service not available in all areas; purchaser is responsible for verifying that service is available for the intended location before purchasing a computer equipped with WAN card. Network details, coverage limitations, and maps at www.verizonwireless.com.

¹⁷ **International Warranty Service (IWS)** is available in any country in which this product is sold and serviced. Service delivery methods and parts availability vary by country, may be different from that in the country of purchase, and are subject to change without notice. Fees and restrictions may apply in some countries.

¹⁹ **Depot repair service:** The customer may be asked certain diagnostic questions before a courier is sent. Your ThinkPad purchase includes this depot repair service, available in the U.S. during the limited warranty period.

²⁰ **Operating System:** Level of support varies by operating system. Operating systems not preloaded on the system may not provide full feature functionality. Refer to lenovo.com/pc/support and enter your machine type and model number for more information.

²² **Lenovo Services:** These services are available for machines normally used for business, professional, or trade purposes, rather than personal, family, or household purposes. Not all machine types and models are covered. Service period begins with the equipment date of purchase. Service must be purchased during the original limited product warranty period. Service levels are response time objectives and are not guarantees. If the machine problem turns out to be a Customer Replaceable Unit (CRU), a part will be express shipped to you for quick replacement. Onsite 24x7x2-hour service is not available in all locations. For ThinkPad notebooks requiring LCD or other component replacement, Lenovo may choose to perform service at the depot repair center. Calls must be received by 5 pm local time in order to qualify for Next Business Day service. P&L means parts and labor. P/U means pick-up. See Lenovo Warranty Services terms and conditions for complete details and restrictions.

²³ **Activating AT&T Wireless Service:** Requires separate agreement with AT&T, subject to service agreement, rate plan and coverage maps. AT&T, not Lenovo, is solely responsible for service. Coverage not available in all areas; AT&T Broadband-Connect available in select metropolitan markets. Special credit and tenure restrictions and additional charges may apply to international roaming. A network connection, third-party software, additional hardware, and/or subscription to a third-party service may be required for certain solutions/applications. Additional restrictions apply, including early termination fee; see www.wireless.att.com for details. To activate call Lenovo Wireless Activation Hot Line at 1-877-299-4710.

²⁶ **Full-size keyboard:** As defined by ISO/IEC 15412.

³⁰ **Measures only maximum** data transfer rate, not application performance. Many factors affect application performance.

²⁴ **Limited onsite service systems** are designed to be repaired during the applicable warranty period primarily with customer-replaceable parts provided by Lenovo. Lenovo will only send a technician onsite to perform a repair if (a) remote telephone diagnosis and/or customer part replacement are unable to resolve the problem, or (b) the part is one of the few designated by Lenovo for onsite replacement. For a list of onsite replaceable parts, contact Lenovo. Support unrelated to a warranty issue may be subject to additional charges. Lenovo onsite repair (LOR), 8 am to 5 pm, Monday through Friday coverage excluding holidays, next business day (NBD) response time.

This publication was developed for products and services offered in the United States. Lenovo may not offer the products, services or features discussed in this document in other countries. Lenovo may withdraw an offering at any time. Information is subject to change without notice. Consult your local representative for information on offerings available in your area.

Lenovo reserves the right to change specifications or other product information without notice. Lenovo is not responsible for photographic or typographical errors. LENOVO PROVIDES THIS PUBLICATION "AS IS," WITHOUT WARRANTY OF ANY KIND, EITHER EXPRESS OR IMPLIED, INCLUDING THE IMPLIED WARRANTIES OF MERCHANTABILITY OR FITNESS FOR A PARTICULAR PURPOSE. Some jurisdictions do not allow disclaimer of express or implied warranties in certain transactions, therefore this disclaimer may not apply to you.

ThinkPad®

Trademarks: Lenovo, the Lenovo logo, New World, New Thinking., Access Connections, Active Protection System, Rescue and Recovery, ThinkPad, ThinkVantage, ThinkVision, ThinkPlus, ThinkCentre, TrackPoint, UltraConnect, UltraNav, and Ultra-bay are trademarks or registered trademarks of Lenovo. The Bluetooth word mark and logos are owned by the Bluetooth SIG, Inc. Any use of such marks by Lenovo is under license. Microsoft, Windows, and Vista are registered trademarks of Microsoft Corporation. Intel, the Intel logo, Intel Inside logo, Intel Core and Core Inside, Intel Centrino logo, Pentium, Celeron and Intel SpeedStep are trademarks or registered trademarks of Intel Corporation or its subsidiaries in the United States and other countries. Cisco and Aironet are registered trademarks of Cisco Corporation. Linux is a trademark of Linus Torvalds in the United States, other countries, or both. Other company, product and service names may be trademarks or service marks of others.

Visit www.lenovo.com/safecomputing periodically for the latest information on safe and effective computing.

Visit www.lenovo.com/psref for the latest version of Product Specifications Reference.

© Lenovo, 2017.
All rights reserved.

Lenovo
1009 Think Place
Morrisville, NC 27560
U.S.A.

ThinkPad.pdf

LenovoTM

ThinkPad[®] Tablets
Convertibles

PSREF



Product Specifications Reference

Version 497, November 2016

U.S.

Visit <http://psref.lenovo.com> for the latest version

Contents

Cover	1	ThinkPad Yoga 460 - TopSeller - 20EM - 1 of 2	34
Contents	2	ThinkPad Yoga 460 - TopSeller - 20EM - 2 of 2	35
Summary Of Change	3	Legal Information	36
ThinkPad Tablets	4		
ThinkPad 10 (2nd Gen)	4		
ThinkPad 10 (2nd Gen) Platform Specifications	5		
ThinkPad 10 (2nd Gen) - TopSeller - 20E3	6		
ThinkPad 10 (2nd Gen) - 20E4	7		
ThinkPad X1 Tablet	8		
ThinkPad X1 Tablet Platform Specifications	9		
ThinkPad X1 Tablet - TopSeller - 20GG - 1 of 2	10		
ThinkPad X1 Tablet - TopSeller - 20GG - 2 of 2	11		
ThinkPad Yoga	12		
ThinkPad P40 Yoga	12		
ThinkPad P40 Yoga Platform Specifications	13		
ThinkPad P40 Yoga - TopSeller - 20GQ	14		
ThinkPad X1 Yoga (1st Gen)	15		
ThinkPad X1 Yoga (1st Gen) Platform Specifications	16		
ThinkPad X1 Yoga (1st Gen) - TopSeller - 20FQ - 1 of 3	17		
ThinkPad X1 Yoga (1st Gen) - TopSeller - 20FQ - 2 of 3	18		
ThinkPad X1 Yoga (1st Gen) - TopSeller - 20FQ - 3 of 3	19		
ThinkPad Yoga 11e (3rd Gen)	20		
ThinkPad Yoga 11e (3rd Gen) Platform Specifications	21		
ThinkPad Yoga 11e (3rd Gen) - TopSeller - 20GA	22		
ThinkPad Yoga 11e (3rd Gen) Chromebook	23		
ThinkPad Yoga 11e (3rd Gen) Chromebook Platform Specifications	24		
ThinkPad Yoga 11e (3rd Gen) Chromebook - TopSeller - 20GE	25		
ThinkPad Yoga 260	26		
ThinkPad Yoga 260 Platform Specifications	27		
ThinkPad Yoga 260 - TopSeller - 20FD - 1 of 2	28		
ThinkPad Yoga 260 - TopSeller - 20FD - 2 of 2	29		
ThinkPad Yoga 260 - TopSeller - 20FE	30		
ThinkPad Yoga 260 - TopSeller - 20GS	31		
ThinkPad Yoga 460	32		
ThinkPad Yoga 460 Platform Specifications	33		

Summary of Changes

This section describes the technical changes made in this edition.

This edition might also include minor corrections and editorial changes which are not identified.

November 2, 2016 - Version 497

Additions in this update

▶ **New product(s)**

None

▶ **New model(s)**

ThinkPad 10 (2nd Gen) new models announced November 2016

ThinkPad X1 Tablet new models announced October 2016

ThinkPad Yoga 260 new models announced November 2016

▶ **Others**

None

Changes in this update

None

Withdrawals in this update

▶ **Withdrawn product(s)**

ThinkPad Helix (2nd Gen) withdrawn November 2016



ThinkPad 10 (2nd Gen) Platform Specifications

Product Specifications Reference (PSREF)

Positioning	<i>Touchscreen tablet with a full PC experience and superior versatility</i>								Camera	<i>Front camera:</i> 1.2-megapixel, fixed focus <i>Rear camera:</i> 5.0-megapixel, auto focus, flash LED
Processor	Intel® Atom Processor								Video capture Audio support	1080p video capture
	Processor Number	# of Cores	# of Threads	Clock Speed	Burst Frequency	Cache	Memory Types	Processor Graphics		Realtek® ALC5672 codec / stereo speakers, 1.0 watt x 2 / 3 digital front microphones, combo audio/microphone jack
	x7-Z8700	4	4	1.60 GHz	2.40 GHz	2MB	LPDDR3-1600	Intel HD Graphics		Audio formats: MP3, AAC, AAC+, eAAC+, WAV, PCM, WMA
	x7-Z8750	4	4	1.60 GHz	2.56 GHz	2MB	LPDDR3-1600		Video formats: MPEG-4, H.263, H.264, VC-1, WMV9, Xvid	
Graphics	Intel HD Graphics in processor, supports 1080p video out via micro-HDMI™ connector, HDCP-compliant								Keyboard	<i>Non-pro:</i> Ultrabook keyboard, mechanical keyboard, pen holder Folio keyboard, thin keyboard, pen loop
Chipset	Intel Atom SoC (System on Chip) platform								Security	Kensington lock slot
Memory	<i>Some:</i> 2GB / 1600MHz LPDDR3, mobile DDR / soldered to systemboard								Security chip	<i>Some:</i> Firmware TPM 2.0, integrated in chipset
	<i>Some:</i> 4GB / 1600MHz LPDDR3, mobile DDR / soldered to systemboard									<i>Some:</i> Discrete TPM 1.2, TCG Certified
	<i>All:</i> no sockets, dual-channel capable									<i>Some:</i> Discrete TPM 1.2 TCG Certified and Firmware TPM 2.0 integrated in chipset
Display	10.1" (256.5mm) WUXGA (1920x1200) TFT color , anti-fingerprint display with Corning® Gorilla® Glass, WideView (170° viewing), LED backlight, 400 nits, 16:10 aspect ratio, 800:1 contrast ratio, IPS,								vPro & iAMT	None
Multi-touch	Multi-touch screen, supports ten-finger gesture								Fingerprint reader	<i>Optional:</i> Fingerprint reader on the A Cover
Pen	<i>Optional:</i> ThinkPad Pen Pro, supports pressure modes / two buttons for input / batteries required (no pen holder in form factor design)								NFC	<i>Optional:</i> Near Field Communication
	Storage	64GB or 128GB / eMMC (embedded Multi Media Card) flash memory on board							Battery - type	Lithium polymer, 32Whr
Optical	None								Battery - life	up to 26 days (standby); up to 10 hr (local video playback)
Storage extension	One microSD card slot, supports up to 128GB								AC adapter	36-watt AC adapter
Ethernet	None								Light sensor	Ambient Light Sensor, InterSil ISL29035
Bluetooth™	Bluetooth 4.0 wireless, integrated in Wi-Fi + Bluetooth combo adapter								G-sensor	3D accelerometer
WLAN	11ac wireless, BCM4356, 802.11ac, 2x2, Wi-Fi + Bluetooth combo chip								Compass	3D compass
WWAN	<i>Optional:</i> Sierra Wireless EM7345, 4G LTE/HSPA/GSM/GPRS/EDGE, GPS								Gyroscope	3D gyrometer
SIM card (Micro)	None								GPS	GPS function is integrated into WWAN module
Smart Card Read	<i>Optional:</i> Smart card reader (SCR)								Preload	<i>Some:</i> Windows 10 Pro 64 <i>Some:</i> Windows 10 Home 64 <i>Some:</i> Windows 10 Home Single Language 64
Dimensions	10.09" x 6.96" x 0.36"; 256.5mm x 177.0mm x 9.10mm 10.09" x 6.96" x 0.67"; 256.5mm x 177.0mm x 17.10mm (with SCR)									<ul style="list-style-type: none"> • Lenovo Solution Center • Lenovo Companion (includes System Update) • Lenovo REACHit • Lenovo Settings • Lenovo SHAREit • Lenovo WRITEit • Microsoft® Office preloaded; purchase a product key to activate • McAfee LiveSafe (30 days of virus definitions)
Weight	<i>WiFi only:</i> from 1.32 lb (0.597kg); <i>WiFi + WWAN:</i> from 1.36 lb (0.618kg); <i>WiFi + WWAN + SCR:</i> from 1.43 lb (0.648kg)								Limited warranty	1-year - depot repair service/ service upgrades available
Case color	Graphite black								Mil-Spec test	MIL-STD-810G military certification
Case material	Polyamide and Glass Fiber Reinforced								Environment	RoHS, GREENGUARD, Low Halogen
Media reader	One microSD card slot (SDXC/SDHC, UHS-I), supports up to 128GB									
Ports	One standard USB 3.0, one micro-HDMI, headphone/microphone combo jack, one Living Hinge Docking connector, one keyboard connector, one micro SIM slot									
Monitor cable	None									
Control buttons	Windows button, power button, volume control button, reset switch									

ThinkPad 10 (2nd Gen) - TopSeller - 20E3

Product Specifications Reference (PSREF)

Model	Region	Processor	Graphics	Memory	Display	Multi-touch	Storage	Optical	WLAN + Bluetooth	WWAN	SIM Card	Smart Card Reader	Camera (Front / Rear)	Keyboard Docking	Smart Cover	Pen	Finger-print Reader	NFC	TPM	Operating System	Warranty	Global	Ann Date (m/y)
20E3000QUS	US	Atom Z8700	Intel HD	2GB Soldered	10.1" WUXGA (1920x1200) IPS	10-point Multi-touch	64GB eMMC	None	11ac, 2x2 + BT4.0	None	None	None	1.2MP / 5.0MP	None	None	None	Finger-print Reader	None	FW TPM 2.0	Win10 Pro 64	1-year, Depot	No	07/15
20E3000RUS	US	Atom Z8700	Intel HD	2GB Soldered	10.1" WUXGA (1920x1200) IPS	10-point Multi-touch	64GB eMMC	None	11ac, 2x2 + BT4.0	Sierra EM7345	None	None	1.2MP / 5.0MP	Non-pro Keyboard	None	None	Finger-print Reader	None	FW TPM 2.0	Win10 Pro 64	1-year, Depot	No	07/15
20E3000SUS	US	Atom Z8700	Intel HD	2GB Soldered	10.1" WUXGA (1920x1200) IPS	10-point Multi-touch	64GB eMMC	None	11ac, 2x2 + BT4.0	None	None	None	1.2MP / 5.0MP	Non-pro Keyboard	None	None	Finger-print Reader	None	FW TPM 2.0	Win10 Pro 64	1-year, Depot	No	07/15
20E3000TUS	US	Atom Z8700	Intel HD	2GB Soldered	10.1" WUXGA (1920x1200) IPS	10-point Multi-touch	64GB eMMC	None	11ac, 2x2 + BT4.0	Sierra EM7345	None	None	1.2MP / 5.0MP	None	None	None	Finger-print Reader	None	FW TPM 2.0	Win10 Pro 64	1-year, Depot	No	07/15
20E3000UUS	US	Atom Z8700	Intel HD	4GB Soldered	10.1" WUXGA (1920x1200) IPS	10-point Multi-touch	128GB eMMC	None	11ac, 2x2 + BT4.0	Sierra EM7345	None	None	1.2MP / 5.0MP	None	None	None	Finger-print Reader	None	FW TPM 2.0	Win10 Pro 64	1-year, Depot	No	07/15
20E3000VUS	US	Atom Z8700	Intel HD	4GB Soldered	10.1" WUXGA (1920x1200) IPS	10-point Multi-touch	128GB eMMC	None	11ac, 2x2 + BT4.0	None	None	None	1.2MP / 5.0MP	None	None	None	Finger-print Reader	None	FW TPM 2.0	Win10 Pro 64	1-year, Depot	No	07/15
20E3000WUS	US	Atom Z8700	Intel HD	4GB Soldered	10.1" WUXGA (1920x1200) IPS	10-point Multi-touch	128GB eMMC	None	11ac, 2x2 + BT4.0	Sierra EM7345	None	None	1.2MP / 5.0MP	Non-pro Keyboard	None	None	Finger-print Reader	None	FW TPM 2.0	Win10 Pro 64	1-year, Depot	No	07/15
20E3000XUS	US	Atom Z8700	Intel HD	4GB Soldered	10.1" WUXGA (1920x1200) IPS	10-point Multi-touch	128GB eMMC	None	11ac, 2x2 + BT4.0	None	None	None	1.2MP / 5.0MP	Non-pro Keyboard	None	None	Finger-print Reader	None	FW TPM 2.0	Win10 Pro 64	1-year, Depot	No	07/15
20E3002DUS	US	Atom Z8700	Intel HD	2GB Soldered	10.1" WUXGA (1920x1200) IPS	10-point Multi-touch	64GB eMMC	None	11ac, 2x2 + BT4.0	Sierra EM7345	None	None	1.2MP / 5.0MP	Non-pro Keyboard	None	None	Finger-print Reader	NFC	FW TPM 2.0	Win10 Pro 64	1-year, Depot	No	11/15
20E3002EUS	US	Atom Z8700	Intel HD	2GB Soldered	10.1" WUXGA (1920x1200) IPS	10-point Multi-touch	64GB eMMC	None	11ac, 2x2 + BT4.0	Sierra EM7345	None	None	1.2MP / 5.0MP	None	None	None	Finger-print Reader	NFC	FW TPM 2.0	Win10 Pro 64	1-year, Depot	No	11/15
20E30031US	US	Atom Z8750	Intel HD	4GB Soldered	10.1" WUXGA (1920x1200) IPS	10-point Multi-touch	128GB eMMC	None	11ac, 2x2 + BT4.0	Sierra EM7345	None	Smart Card Reader	1.2MP / 5.0MP	None	None	None	Finger-print Reader	None	dTPM1.2 + FW TPM2.0	Win10 Pro 64	1-year, Depot	No	04/16
20E30032US	US	Atom Z8750	Intel HD	4GB Soldered	10.1" WUXGA (1920x1200) IPS	10-point Multi-touch	128GB eMMC	None	11ac, 2x2 + BT4.0	None	None	None	1.2MP / 5.0MP	None	None	None	Finger-print Reader	None	dTPM1.2 + FW TPM2.0	Win10 Pro 64	1-year, Depot	No	04/16
20E30033US	US	Atom Z8750	Intel HD	2GB Soldered	10.1" WUXGA (1920x1200) IPS	10-point Multi-touch	64GB eMMC	None	11ac, 2x2 + BT4.0	Sierra EM7345	None	None	1.2MP / 5.0MP	None	None	None	Finger-print Reader	NFC	dTPM1.2 + FW TPM2.0	Win10 Pro 64	1-year, Depot	No	04/16
20E30034US	US	Atom Z8750	Intel HD	4GB Soldered	10.1" WUXGA (1920x1200) IPS	10-point Multi-touch	128GB eMMC	None	11ac, 2x2 + BT4.0	Sierra EM7345	None	None	1.2MP / 5.0MP	None	None	None	Finger-print Reader	NFC	dTPM1.2 + FW TPM2.0	Win10 Pro 64	1-year, Depot	No	04/16
20E30035US	US	Atom Z8750	Intel HD	2GB Soldered	10.1" WUXGA (1920x1200) IPS	10-point Multi-touch	64GB eMMC	None	11ac, 2x2 + BT4.0	None	None	None	1.2MP / 5.0MP	None	None	None	Finger-print Reader	None	dTPM1.2 + FW TPM2.0	Win10 Pro 64	1-year, Depot	No	04/16
20E3003HUS	US	Atom Z8750	Intel HD	2GB Soldered	10.1" WUXGA (1920x1200) IPS	10-point Multi-touch	64GB eMMC	None	11ac, 2x2 + BT4.0	Sierra EM7345	None	None	1.2MP / 5.0MP	None	Cover	None	Finger-print Reader	None	dTPM1.2 + FW TPM2.0	Win10 Pro 64	1-year, Depot	No	11/16
20E3003JUS	US	Atom Z8750	Intel HD	4GB Soldered	10.1" WUXGA (1920x1200) IPS	10-point Multi-touch	128GB eMMC	None	11ac, 2x2 + BT4.0	Sierra EM7345	None	None	1.2MP / 5.0MP	None	None	None	Finger-print Reader	None	dTPM1.2 + FW TPM2.0	Win10 Pro 64	1-year, Depot	No	11/16

ThinkPad 10 (2nd Gen) - 20E4

Product Specifications Reference (PSREF)

Model	Region	Processor	Graphics	Memory	Display	Multi-touch	Storage	Optical	WLAN + Bluetooth	WWAN	SIM Card	Smart Card Reader	Camera (Front / Rear)	Keyboard Docking	Smart Cover	Pen	Finger-print Reader	NFC	TPM	Operating System	Warranty	Global	Ann Date (m/y)
20E40006US	US	Atom Z8700	Intel HD	2GB Soldered	10.1" WUXGA (1920x1200) IPS	10-point Multi-touch	64GB eMMC	None	11ac, 2x2 + BT4.0	None	None	None	1.2MP / 5.0MP	None	None	None	Finger-print Reader	None	FW TPM 2.0	Win10 Pro 64	1-year, Depot	No	07/15
20E40007US	US	Atom Z8700	Intel HD	2GB Soldered	10.1" WUXGA (1920x1200) IPS	10-point Multi-touch	64GB eMMC	None	11ac, 2x2 + BT4.0	None	None	None	1.2MP / 5.0MP	Non-pro Keyboard	None	None	Finger-print Reader	None	FW TPM 2.0	Win10 Pro 64	1-year, Depot	No	07/15
20E40008US	US	Atom Z8700	Intel HD	4GB Soldered	10.1" WUXGA (1920x1200) IPS	10-point Multi-touch	128GB eMMC	None	11ac, 2x2 + BT4.0	None	None	None	1.2MP / 5.0MP	None	None	None	Finger-print Reader	None	FW TPM 2.0	Win10 Pro 64	1-year, Depot	No	07/15
20E40009US	US	Atom Z8700	Intel HD	4GB Soldered	10.1" WUXGA (1920x1200) IPS	10-point Multi-touch	128GB eMMC	None	11ac, 2x2 + BT4.0	None	None	None	1.2MP / 5.0MP	Non-pro Keyboard	None	None	Finger-print Reader	None	FW TPM 2.0	Win10 Pro 64	1-year, Depot	No	07/15
20E4000AUS	US	Atom Z8700	Intel HD	2GB Soldered	10.1" WUXGA (1920x1200) IPS	10-point Multi-touch	64GB eMMC	None	11ac, 2x2 + BT4.0	Sierra EM7345	None	None	1.2MP / 5.0MP	None	None	None	Finger-print Reader	None	FW TPM 2.0	Win10 Pro 64	1-year, Depot	No	07/15
20E4000BUS	US	Atom Z8700	Intel HD	4GB Soldered	10.1" WUXGA (1920x1200) IPS	10-point Multi-touch	128GB eMMC	None	11ac, 2x2 + BT4.0	Sierra EM7345	None	None	1.2MP / 5.0MP	None	None	None	Finger-print Reader	None	FW TPM 2.0	Win10 Pro 64	1-year, Depot	No	07/15



ThinkPad X1 Tablet Platform Specifications

Product Specifications Reference (PSREF)

Processor	6th Generation Intel® Core™ M Processor									Ports	One standard USB 3.0, one USB Type-C, one Mini DisplayPort, headphone/microphone combo jack, one Pogo keyboard connector, one cartridge connector for optional modules, one nano-SIM slot
	Processor Number	# of Cores	# of Threads	Clock Speed	Burst Frequency	Cache	Memory Types	Processor Graphics	vPro		
	m3-6Y30	2	4	0.90 GHz	2.20 GHz	4MB	LPDDR3-1866	Intel HD Graphics 515	No		
	m5-6Y54	2	4	1.10 GHz	2.70 GHz	4MB			No		
	m5-6Y57	2	4	1.10 GHz	2.80 GHz	4MB			Yes		
m7-6Y75	2	4	1.20 GHz	3.10 GHz	4MB	Yes					
Graphics	Intel HD Graphics 515 in processor, supports 1080p video out via Mini DisplayPort connector									Control buttons	Power button, volume control button, reset switch
Chipset	Intel SoC (System on Chip) platform									WiGig dock	<i>Optional:</i> WiGig dock, mutually exclusive with IR camera
Memory	<i>Some:</i> 4GB / 1866MHz LPDDR3, mobile DDR / soldered to systemboard									Monitor Cable	<i>mDP-HDMI:</i> Lenovo Mini DisplayPort to HDMI Monitor Cable
	<i>Some:</i> 8GB / 1866MHz LPDDR3, mobile DDR / soldered to systemboard									<i>(optional)</i>	<i>mDP-VGA:</i> Lenovo Mini DisplayPort to VGA Monitor Cable
	<i>Some:</i> 16GB / 1866MHz LPDDR3, mobile DDR / soldered to systemboard									Adapter <i>(optional)</i>	<i>USB-RJ45:</i> USB 3.0 to RJ45 adapter
	<i>All:</i> no sockets, dual-channel capable										<i>USB-C-VGA:</i> USB-C to VGA plus power adapter
											<i>USB-C-HDMI:</i> USB-C to HDMI plus power adapter
Display	12.0" (304.8mm) FHD+ (2160x1440), glare, LED backlight, IPS, anti-fingerprint display with Corning® Gorilla® Glass, WideView (170° viewing), 360 nits, 3:2 aspect ratio, 800:1 contrast ratio									Camera	<i>Front camera:</i> 2.0-megapixel, fixed focus
Multi-touch	Capacitive touch panel, supports ten-finger gesture									Optional Cameras	<i>Rear camera:</i> 8.0-megapixel, auto focus, flash LED
Pen	<i>Optional:</i> ThinkPad Pen Pro, active pen for multi-touch display									Video capture	<i>3D camera:</i> RealSense R200 3D camera on 3D Imaging module
Kick stand	Opening angle up to 90 degrees									Audio support	<i>IR camera:</i> infra-red (IR) camera, mutually exclusive WiGig and NFC
Storage	<i>Some:</i> M.2 SSD / SATA 6.0Gb/s									Pogo Keyboard	Magnetic attached thin keyboard, with TrackPoint® pointing device and buttonless Mylar surface touchpad, multi-touch
	<i>Some:</i> M.2 SSD / PCIe NVMe, PCIe 3.0 x 4, 32Gb/s									Keyboard color	Black, red, and silver
Optical	None									Security	Kensington lock slot
Storage extension	One microSD card slot, supports up to 64GB									Security chip	Discrete TPM 1.2 TCG Certified and Firmware TPM 2.0 integrated in chipset
Ethernet	None									vPro <i>(optional)</i>	Intel vPro Technology
WLAN	<i>One of the following, configurable by model (WiGig is mutually exclusive with IR camera):</i>									Fingerprint reader	<i>Optional:</i> Touch style Fingerprint reader
	<ul style="list-style-type: none"> 11ac+BT, Intel Dual Band Wireless-AC 8260, 2x2, M.2 Card WiGig™+11AC+BT, Intel Tri-Band Wireless-AC 18260, 2x2 WLAN, WiGig, M.2 Card 									NFC	<i>Optional:</i> Near Field Communication, mutually exclusive IR camera
Bluetooth™	Bluetooth wireless, integrated in Wi-Fi + Bluetooth combo adapter									Module	<i>One of the following, configurable by model</i>
WWAN	<i>One of the following, configurable by model:</i>										<ul style="list-style-type: none"> Dummy base cartridge Productivity module, USB3.0 x 1, HDMI, OneLink+, 5 hrs battery (24Whr) Presenter module, Pico projector, HDMI and 10Whr battery for presenter 3D imaging module, USB3.0 x 1, RealSense 3D camera and HDMI
	<ul style="list-style-type: none"> Wireless WAN, Sierra Wireless EM7455, Qualcomm® 4G LTE-Advanced/DC-HSPA+/HSPA+/UMTS/GNSS, M.2 card 									Battery - type	Lithium polymer, 37Whr
SIM card	Nano-SIM, optional Lenovo Connect (WE) SIM card									Battery - life	up to 10 hr (local video playback)
Dimensions	<i>Tablet only:</i> 11.48" x 8.25" x 0.34"; 291.5mm x 209.5mm x 8.75mm									AC adapter	45-watt USB Type-C adapter
Weight	<i>Tablet only:</i> from 1.69 lb, 767g;									Light sensor	Ambient Light Sensor
	<i>Tablet+keyboard:</i> from 2.35 lb, 1.07kg (767g+300g);									G-sensor	3D accelerometer
	<i>Tablet+keyboard+Productivity:</i> from 2.89 lb, 1.31kg (767g+300g+245g);									Compass	3D compass
	<i>Tablet+Productivity:</i> from 2.23 lb, 1.01kg (767g+245g);									Gyroscope	3D gyrometer
	<i>Tablet+Presenter:</i> from 2.15 lb, 0.98kg (767g+210g);									GPS	GPS function is integrated into WWAN module
	<i>Tablet+3D Imaging:</i> from 2.06 lb, 0.94kg (767g+168g)									Preload	<i>Some:</i> Windows 10 Pro 64
Case color	Black										<i>Some:</i> Windows 10 Home 64
Case material	Magnesium + PPS Hybrid injection										<ul style="list-style-type: none"> Lenovo Solution Center Lenovo Companion Lenovo Settings Microsoft® Office preloaded; purchase a product key to activate
Smart Card Read	<i>Optional:</i> NFC-compatible smart card reader via NFC									Limited warranty	1-year - depot repair service/ service upgrades available
Media reader	One microSD card slot (micro SD/SDXC/SDHC), supports up to 64GB										3-year - depot repair service/ service upgrades available
										Mil-Spec test	MIL-STD-810G military certification
										Environment	EPEAT™ Gold, RoHS, GREENGUARD, Low Halogen

Model	Region	Processor	vPro	Graphics	Memory	Display	Multi-touch	Storage(HDD/SSD)	WLAN + Bluetooth	WWAN	SIM Card	Dock	Monitor Cable	Camera (Front / Rear)	Keyboard Docking	Pen	Fingerprint Reader	NFC	Module	Battery	Power Adapter	Operating System	Warranty	Ann Date (m/y)
20GG0000US	US	m3-6Y30	No	Intel HD 515	4GB Soldered	12" FHD+ (2160x1440) IPS	10-point Multi-touch	192GB SSD M.2	8260 ac, 2x2 + BT4.1	None	None	None	None	2.0MP / 8.0MP	Black Pogo Keyboard	ThinkPad Pen Pro	Fingerprint Reader	None	None	2-cell (37Wh)	45W	Windows 10 Pro 64	1-year, Depot	08/16
20GG001JUS	US	m5-6Y57	vPro	Intel HD 515	8GB Soldered	12" FHD+ (2160x1440) IPS	10-point Multi-touch	192GB SSD M.2	8260 ac, 2x2 + BT4.1	None	None	None	None	2.0MP / 8.0MP	Black Pogo Keyboard	ThinkPad Pen Pro	Fingerprint Reader	None	None	2-cell (37Wh)	45W	Windows 10 Pro 64	3-year, Depot	08/16
20GG001KUS	US	m5-6Y57	vPro	Intel HD 515	8GB Soldered	12" FHD+ (2160x1440) IPS	10-point Multi-touch	256GB SSD M.2 SATA3 Opal2	8260 ac, 2x2 + BT4.1	None	None	None	None	2.0MP / 8.0MP	Black Pogo Keyboard	ThinkPad Pen Pro	Fingerprint Reader	None	None	2-cell (37Wh)	45W	Windows 10 Pro 64	1-year, Depot	08/16
20GG001LUS	US	m5-6Y57	vPro	Intel HD 515	8GB Soldered	12" FHD+ (2160x1440) IPS	10-point Multi-touch	512GB SSD M.2	8260 ac, 2x2 + BT4.1	None	None	None	None	2.0MP / 8.0MP	Black Pogo Keyboard	ThinkPad Pen Pro	Fingerprint Reader	None	None	2-cell (37Wh)	45W	Windows 10 Pro 64	3-year, Depot	08/16
20GG001MUS	US	m3-6Y30	No	Intel HD 515	4GB Soldered	12" FHD+ (2160x1440) IPS	10-point Multi-touch	256GB SSD M.2 SATA3 Opal2	8260 ac, 2x2 + BT4.1	None	None	None	None	2.0MP / 8.0MP	Black Pogo Keyboard	ThinkPad Pen Pro	Fingerprint Reader	None	None	2-cell (37Wh)	45W	Windows 10 Pro 64	1-year, Depot	08/16
20GG001NUS	US	m7-6Y75	vPro	Intel HD 515	8GB Soldered	12" FHD+ (2160x1440) IPS	10-point Multi-touch	256GB SSD M.2 SATA3 Opal2	8260 ac, 2x2 + BT4.1	None	None	None	None	2.0MP / 8.0MP	Black Pogo Keyboard	ThinkPad Pen Pro	Fingerprint Reader	None	None	2-cell (37Wh)	45W	Windows 10 Pro 64	1-year, Depot	08/16
20GG001PUS	US	m7-6Y75	vPro	Intel HD 515	8GB Soldered	12" FHD+ (2160x1440) IPS	10-point Multi-touch	256GB SSD M.2 SATA3 Opal2	8260 ac, 2x2 + BT4.1	None	None	None	None	2.0MP / 8.0MP	Black Pogo Keyboard	ThinkPad Pen Pro	Fingerprint Reader	None	None	2-cell (37Wh)	45W	Windows 10 Pro 64	3-year, Depot	08/16
20GG001QUS	US	m7-6Y75	vPro	Intel HD 515	8GB Soldered	12" FHD+ (2160x1440) IPS	10-point Multi-touch	512GB SSD M.2	8260 ac, 2x2 + BT4.1	None	None	None	None	2.0MP / 8.0MP	Black Pogo Keyboard	ThinkPad Pen Pro	Fingerprint Reader	None	None	2-cell (37Wh)	45W	Windows 10 Pro 64	3-year, Depot	08/16
20GG001RUS	US	m7-6Y75	vPro	Intel HD 515	16GB Soldered	12" FHD+ (2160x1440) IPS	10-point Multi-touch	256GB SSD M.2 SATA3 Opal2	18260 ac, 2x2 + BT4.1	None	None	WiGig Dock	None	2.0MP / 8.0MP	Black Pogo Keyboard	ThinkPad Pen Pro	Fingerprint Reader	None	None	2-cell (37Wh)	45W	Windows 10 Pro 64	3-year, Depot	08/16
20GG001SUS	US	m7-6Y75	vPro	Intel HD 515	16GB Soldered	12" FHD+ (2160x1440) IPS	10-point Multi-touch	512GB SSD M.2	18260 ac, 2x2 + BT4.1	None	None	WiGig Dock	None	2.0MP / 8.0MP	Black Pogo Keyboard	ThinkPad Pen Pro	Fingerprint Reader	None	None	2-cell (37Wh)	45W	Windows 10 Pro 64	3-year, Depot	08/16
20GG001UUS	US	m3-6Y30	No	Intel HD 515	4GB Soldered	12" FHD+ (2160x1440) IPS	10-point Multi-touch	128GB SSD M.2	8260 ac, 2x2 + BT4.1	None	None	None	None	2.0MP / 8.0MP	Black Pogo Keyboard	ThinkPad Pen Pro	Fingerprint Reader	None	None	2-cell (37Wh)	45W	Windows 10 Pro 64	1-year, Depot	08/16
20GG001VUS	US	m5-6Y57	vPro	Intel HD 515	4GB Soldered	12" FHD+ (2160x1440) IPS	10-point Multi-touch	128GB SSD M.2	8260 ac, 2x2 + BT4.1	None	None	None	None	2.0MP / 8.0MP	Black Pogo Keyboard	ThinkPad Pen Pro	Fingerprint Reader	None	None	2-cell (37Wh)	45W	Windows 10 Pro 64	1-year, Depot	08/16
20GG002DUS	US	m5-6Y57	vPro	Intel HD 515	8GB Soldered	12" FHD+ (2160x1440) IPS	10-point Multi-touch	256GB SSD M.2 SATA3 Opal2	8260 ac, 2x2 + BT4.1	Sierra EM7455	None	None	None	2.0MP / 8.0MP	Black Pogo Keyboard	ThinkPad Pen Pro	Fingerprint Reader	NFC	None	2-cell (37Wh)	45W	Windows 10 Pro 64	3-year, Depot	05/16
20GG002EUS	US	m7-6Y75	vPro	Intel HD 515	8GB Soldered	12" FHD+ (2160x1440) IPS	10-point Multi-touch	256GB SSD M.2 SATA3 Opal2	8260 ac, 2x2 + BT4.1	Sierra EM7455	None	None	None	2.0MP / 8.0MP	Black Pogo Keyboard	ThinkPad Pen Pro	Fingerprint Reader	NFC	None	2-cell (37Wh)	45W	Windows 10 Pro 64	3-year, Depot	05/16
20GG002FUS	US	m7-6Y75	vPro	Intel HD 515	8GB Soldered	12" FHD+ (2160x1440) IPS	10-point Multi-touch	512GB SSD M.2	8260 ac, 2x2 + BT4.1	Sierra EM7455	None	None	None	2.0MP / 8.0MP	Black Pogo Keyboard	ThinkPad Pen Pro	Fingerprint Reader	NFC	None	2-cell (37Wh)	45W	Windows 10 Pro 64	3-year, Depot	05/16
20GG0031US	US	m7-6Y75	vPro	Intel HD 515	16GB Soldered	12" FHD+ (2160x1440) IPS	10-point Multi-touch	256GB SSD M.2 SATA3 Opal2	8260 ac, 2x2 + BT4.1	Sierra EM7455	None	None	None	2.0MP / 8.0MP	Black Pogo Keyboard	ThinkPad Pen Pro	Fingerprint Reader	NFC	None	2-cell (37Wh)	45W	Windows 10 Pro 64	1-year, Depot	04/16
20GG0032US	US	m7-6Y75	vPro	Intel HD 515	16GB Soldered	12" FHD+ (2160x1440) IPS	10-point Multi-touch	256GB SSD M.2 SATA3 Opal2	8260 ac, 2x2 + BT4.1	None	None	None	None	2.0MP / 8.0MP	Black Pogo Keyboard	ThinkPad Pen Pro	Fingerprint Reader	None	None	2-cell (37Wh)	45W	Windows 10 Pro 64	1-year, Depot	08/16
20GG0033US	US	m7-6Y75	vPro	Intel HD 515	16GB Soldered	12" FHD+ (2160x1440) IPS	10-point Multi-touch	512GB SSD M.2	8260 ac, 2x2 + BT4.1	Sierra EM7455	None	None	None	2.0MP / 8.0MP	Black Pogo Keyboard	ThinkPad Pen Pro	Fingerprint Reader	NFC	None	2-cell (37Wh)	45W	Windows 10 Pro 64	1-year, Depot	08/16
20GG0034US	US	m7-6Y75	vPro	Intel HD 515	16GB Soldered	12" FHD+ (2160x1440) IPS	10-point Multi-touch	512GB SSD M.2	8260 ac, 2x2 + BT4.1	None	None	None	None	2.0MP / 8.0MP	Black Pogo Keyboard	ThinkPad Pen Pro	Fingerprint Reader	None	None	2-cell (37Wh)	45W	Windows 10 Pro 64	1-year, Depot	08/16
20GG004XUS	US	m7-6Y75	vPro	Intel HD 515	16GB Soldered	12" FHD+ (2160x1440) IPS	10-point Multi-touch	512GB SSD M.2	8260 ac, 2x2 + BT4.1	Sierra EM7455	None	None	None	2.0MP / 8.0MP	Black Pogo Keyboard	ThinkPad Pen Pro	Fingerprint Reader	None	None	2-cell (37Wh)	45W	Windows 10 Pro 64	1-year, Depot	10/16

Model	Region	Processor	vPro	Graphics	Memory	Display	Multi-touch	Storage(HDD/SSD)	WLAN + Bluetooth	WWAN	SIM Card	Dock	Monitor Cable	Camera (Front / Rear)	Keyboard Docking	Pen	Fingerprint Reader	NFC	Module	Battery	Power Adapter	Operating System	Warranty	Ann Date (m/y)
20GG004YUS	US	m7-6Y75	vPro	Intel HD 515	8GB Soldered	12" FHD+ (2160x1440) IPS	10-point Multi-touch	256GB SSD M.2 SATA3 Opal2	8260 ac, 2x2 + BT4.1	Sierra EM7455	None	None	None	2.0MP / 8.0MP	Black Pogo Keyboard	ThinkPad Pen Pro	Fingerprint Reader	None	None	2-cell (37Wh)	45W	Windows 10 Pro 64	3-year, Depot	10/16
20GG0050US	US	m7-6Y75	vPro	Intel HD 515	16GB Soldered	12" FHD+ (2160x1440) IPS	10-point Multi-touch	256GB SSD M.2 SATA3 Opal2	8260 ac, 2x2 + BT4.1	Sierra EM7455	None	None	None	2.0MP / 8.0MP	Black Pogo Keyboard	ThinkPad Pen Pro	Fingerprint Reader	None	None	2-cell (37Wh)	45W	Windows 10 Pro 64	3-year, Depot	10/16
20GG0051US	US	m5-6Y57	vPro	Intel HD 515	8GB Soldered	12" FHD+ (2160x1440) IPS	10-point Multi-touch	256GB SSD M.2 SATA3 Opal2	8260 ac, 2x2 + BT4.1	Sierra EM7455	None	None	None	2.0MP / 8.0MP	Black Pogo Keyboard	ThinkPad Pen Pro	Fingerprint Reader	None	None	2-cell (37Wh)	45W	Windows 10 Pro 64	3-year, Depot	10/16
20GG0052US	US	m7-6Y75	vPro	Intel HD 515	16GB Soldered	12" FHD+ (2160x1440) IPS	10-point Multi-touch	512GB SSD M.2	8260 ac, 2x2 + BT4.1	Sierra EM7455	None	None	None	2.0MP / 8.0MP	Black Pogo Keyboard	ThinkPad Pen Pro	Fingerprint Reader	None	None	2-cell (37Wh)	45W	Windows 10 Pro 64	3-year, Depot	10/16
20GG0053US	US	m7-6Y75	vPro	Intel HD 515	16GB Soldered	12" FHD+ (2160x1440) IPS	10-point Multi-touch	256GB SSD M.2 SATA3 Opal2	8260 ac, 2x2 + BT4.1	Sierra EM7455	None	None	None	2.0MP / 8.0MP	Black Pogo Keyboard	ThinkPad Pen Pro	Fingerprint Reader	None	None	2-cell (37Wh)	45W	Windows 10 Pro 64	1-year, Depot	10/16
20GG0054US	US	m7-6Y75	vPro	Intel HD 515	8GB Soldered	12" FHD+ (2160x1440) IPS	10-point Multi-touch	512GB SSD M.2	8260 ac, 2x2 + BT4.1	Sierra EM7455	None	None	None	2.0MP / 8.0MP	Black Pogo Keyboard	ThinkPad Pen Pro	Fingerprint Reader	None	None	2-cell (37Wh)	45W	Windows 10 Pro 64	3-year, Depot	10/16



ThinkPad P40 Yoga Platform Specifications

Product Specifications Reference (PSREF)

Processor	6th Generation Intel® Core™ i7 Processor									Ports	Three USB 3.0 (one Always On), Mini DisplayPort, HDMI, Onelink+ connector, combo audio / microphone jack	
	Processor Number	# of Cores	# of Threads	Base Frequency	Max Turbo Frequency	Cache	Memory Types	Processor Graphics	vPro	Adapter (optional)	HDMI-VGA: Lenovo HDMI to VGA Monitor Cable mDP-VGA: Lenovo Mini DisplayPort to VGA Monitor Cable RJ45: ThinkPad Onelink+ to RJ45 adapter VGA/RJ45: ThinkPad Onelink+ to VGA/RJ45 adapter	
	i7-6500U	2	4	2.5 GHz	3.1 GHz	4MB	DDR3L-1600	Intel HD Graphics 520	No			
	i7-6600U			2.6 GHz	3.4 GHz	4MB		vPro				
Graphics	Intel HD Graphics 520 in processor and Nvidia Quadro M500M Graphics, 2GB DDR3 memory, supports external digital monitor via HDMI, or Mini DisplayPort; supports dual independent display; Max resolution: 3840x2160 (Mini DisplayPort)@60Hz; 1920x1080 (HDMI)@60Hz									Camera	HD720p resolution, fixed focus	
Chipset	Intel SoC (System on Chip) platform									Audio support	HD Audio, Conexant® CX11852 codec, Dolby® DAX2 / stereo speakers, 1.5W x 2 / dual array microphone, combo audio / microphone jack	
Memory	16GB max / 1600MHz DDR3L / one 204-pin SO-DIMM sockets									Keyboard	6-row, spill-resistant, multimedia Fn keys, LED backlit	
Display	Some: 14.0" (355mm) WQHD (2560x1440), glare, LED backlight, IPS, 300 nits, 16:9 aspect ratio, 700:1 contrast ratio Some: 14.0" (355mm) FHD (1920x1080), anti-glare, LED backlight, IPS, 250 nits, 16:9 aspect ratio, 700:1 contrast ratio									UltraNav™	TrackPoint® pointing device and buttonless Mylar surface touchpad, multi-touch	
Multi-touch	Capacitive touch panel, supports 10-finger gesture									Security	Power-on password, hard disk password, supervisor password, security keyhole	
Hinge	Yoga hinge, 360 degree									Security chip	Discrete TPM 1.2 TCG Certified and Firmware TPM 2.0 integrated in chipset	
Convert-mode	Laptop, tent, stand, and tablet									vPro (optional)	Intel vPro Technology	
Pen	ThinkPad Pen Pro, active pen for multi-touch display									Fingerprint reader	Swipe fingerprint reader under C cover	
Storage	SSD / SATA 6.0Gb/s, 2.5" wide, 7mm high									NFC	None	
Optical	None									Battery type	Li-Polymer 3-cell (53Wh)	
Ethernet	Gigabit Ethernet via optional Ethernet (RJ-45) adapter (by native Intel Ethernet Connection I219-V (Non-vPro) or I219-LM (vPro))									Battery life	Up to 8.0 hr	
WLAN	11ac+BT, Intel Dual Band Wireless-AC 8260, 2x2, M.2 Card									AC adapter	65W AC adapter	
Bluetooth™	Bluetooth wireless, integrated in Wi-Fi + Bluetooth combo adapter									Light sensor	Ambient Light Sensor	
WWAN (optional)	Wireless WAN, Sierra Wireless EM7455, Qualcomm® 4G LTE-Advanced/DC-HSPA+/HSPA+/HSPA/UMTS/GNSS, M.2 card									G-sensor	3D accelerometer	
SIM card	Micro-SIM card slot									Compass	3D compass	
Dimensions	WxDxH: 13.30" x 9.30" x 0.78"; 338.0mm x 236.3mm x 19.9mm									Gyroscope	3D gyrometer	
Weight	From 3.96 lb (1.80kg)									Preload	Windows® 7 Professional 64 preinstalled through downgrade rights in Windows 10 Pro 64 Some: Windows 10 Pro 64	
Case color	Black										<ul style="list-style-type: none"> • Lenovo Solution Center • Lenovo SHAREit • Lenovo Companion • Lenovo Settings • Microsoft Office preloaded; purchase a product key to activate • McAfee® Live Safe (30-day trial) 	
Case material	Carbon-Fiber Hybrid										<ul style="list-style-type: none"> • Microsoft® Office preloaded; purchase a product key to activate • McAfee® Live Safe (30-day trial) 	
Smart card reader	None										For ISV certifications, please visit www.lenovo.com/support/ISV	
Media reader	4-in-1 reader (MMC, SD, SDHC, SDXC)									Limited warranty	One of the following, configurable by model: <ul style="list-style-type: none"> • 1-year depot repair service • 3-year/1-yr battery depot repair service 	
										Mil-Spec test	MIL-STD-810G military certification	
										Environment	EPEAT™ Gold; ENERGY STAR®; RoHS-compliant	

ThinkPad P40 Yoga - TopSeller - 20GQ

Product Specifications Reference (PSREF)

Model	Region	Processor	vPro	Graphics	Memory	Display	Multi-touch	Case Material	Storage	Optical	WLAN + Bluetooth	WWAN	SIM Card	Monitor Cable	Adapter	Color	Camera	Keyboard	Pen	Finger-print Reader	NFC	TPM	Battery	Power Adapter	Operating System	Warranty	Global	Ann Date (m/y)
20GQ000BUS	US	i7-6500U	No	M500M 2GB	8GBx1	14" FHD (1920x1080) IPS AG	10-point Multi-touch	Carbon	256GB SSD Opal2	None	Intel 8260 ac, 2x2 + BT4.1	None	None	None	None	Black	720p	Backlit	Pen Pro	Finger-print Reader	None	dTPM1.2 + FW TPM2.0	3-cell (53Wh)	65W	Win10 Pro 64	1-year, Depot	No	02/16
20GQ000CUS	US	i7-6600U	vPro	M500M 2GB	8GBx1	14" FHD (1920x1080) IPS AG	10-point Multi-touch	Carbon	256GB SSD Opal2	None	Intel 8260 ac, 2x2 + BT4.1	None	None	None	None	Black	720p	Backlit	Pen Pro	Finger-print Reader	None	dTPM1.2 + FW TPM2.0	3-cell (53Wh)	65W	Win10 Pro 64	1-year, Depot	No	02/16
20GQ000EUS	US	i7-6600U	vPro	M500M 2GB	16GBx1	14" WQHD (2560x1440) IPS Glossy	10-point Multi-touch	Carbon	512GB SSD	None	Intel 8260 ac, 2x2 + BT4.1	None	None	None	None	Black	720p	Backlit	Pen Pro	Finger-print Reader	None	dTPM1.2 + FW TPM2.0	3-cell (53Wh)	65W	Win10 Pro 64	1-year, Depot	No	02/16



ThinkPad X1 Yoga Platform Specifications

Product Specifications Reference (PSREF)

Processor	6th Generation Intel® Core™ i3 / i5 / i7 Processor									Smart card reader	None
	Processor Number	# of Cores	# of Threads	Base Frequency	Max Turbo Frequency	Cache	Memory Types	Processor Graphics	vPro	Media reader	Micro SD, supports UHS-II SD card
	i5-6200U	2	4	2.3 GHz	2.8 GHz	3MB	LPDDR3-1866	Intel HD Graphics 520	No	Ports	Three USB 3.0 (one Always On), Mini DisplayPort, HDMI, Onelink+ connector, combo audio / microphone jack
	i5-6300U			2.4 GHz	3.0 GHz	3MB		vPro			
	i7-6500U			2.5 GHz	3.1 GHz	4MB		No			
	i7-6600U			2.6 GHz	3.4 GHz	4MB		vPro			
Graphics	Intel HD Graphics 520 in processor only, supports external digital monitor via HDMI or Mini DisplayPort; supports dual independent displays; Max resolution: 3840x2160 (Mini DisplayPort) @60Hz; 4096x2160 (HDMI) @24Hz									WiGig dock Adapter (optional)	<p>Optional: WiGig dock, mutually exclusive with WWAN</p> <p>HDMI-VGA: Lenovo HDMI to VGA Monitor Cable</p> <p>mDP-VGA: Lenovo Mini DisplayPort to VGA Monitor Cable</p> <p>RJ45: ThinkPad OneLink+ to RJ45 adapter</p> <p>VGA/RJ45: ThinkPad OneLink+ to VGA/RJ45 adapter</p>
Chipset	Intel SoC (System on Chip) platform									Camera	HD720p resolution, fixed focus
Memory	16GB max / 1866MHz LPDDR3 / soldered to systemboard									Audio support	HD Audio, Conexant® CX11852 codec, Dolby® DAX2 / stereo speakers, 2W x 2 / dual array microphone, combo audio / microphone jack
Display	<p><i>Some:</i> 14.0" (355mm) WQHD (2560x1440), glare, OLED, 300 nits, 16:9 aspect ratio, 2000000:1 contrast ratio</p> <p><i>Some:</i> 14.0" (355mm) WQHD (2560x1440), anti-glare, LED backlight, IPS, 270 nits, 16:9 aspect ratio, 700:1 contrast ratio</p> <p><i>Some:</i> 14.0" (355mm) FHD (1920x1080), anti-glare, LED backlight, IPS, 270 nits, 16:9 aspect ratio, 700:1 contrast ratio</p>									Keyboard	6-row, spill-resistant, multimedia Fn keys, LED backlit UltraNav™
Multi-touch	Capacitive touch panel, supports 10-finger gesture									Security chip	Power-on password, hard disk password, supervisor password, security keyhole
Hinge	Yoga hinge, 360 degree									vPro (optional)	Intel vPro Technology
Convert-mode	Laptop, tent, stand, and tablet									Fingerprint reader	Touch style fingerprint reader on the keyboard bezel
Pen (optional)	ThinkPad Pen Pro, active pen for multi-touch display									NFC	None
Storage	<p><i>Some:</i> M.2 SSD / SATA 6.0Gb/s</p> <p><i>Some:</i> M.2 SSD / PCIe NVMe, PCIe 3.0 x 4, 32Gb/s</p>									Battery type	Li-Polymer 4-cell (52Wh) or 4-cell (56Wh, OLED models only)
Optical	None									Battery life	Up to 11.0 hr
Ethernet	Gigabit Ethernet via optional Ethernet (RJ-45) adapter (by native Intel Ethernet Connection I219-V (Non-vPro) or I219-LM (vPro))									AC adapter	45W or 65W AC adapter
WLAN	<p><i>One of the following, configurable by model (WiGig is mutually exclusive with WWAN):</i></p> <ul style="list-style-type: none"> 11ac+BT, Intel Dual Band Wireless-AC 8260, 2x2, M.2 Card WiGig™+11AC+BT, Intel Tri-Band Wireless-AC 8260, 2x2 WLAN, WiGig, M.2 Card 									Light sensor	Ambient Light Sensor
Bluetooth™	Bluetooth wireless, integrated in Wi-Fi + Bluetooth combo adapter									G-sensor	3D accelerometer and 3D magnetometer
WWAN (optional)	<p><i>One of the following, configurable by model (mutually exclusive with WiGig):</i></p> <ul style="list-style-type: none"> Wireless WAN, Sierra Wireless EM7455, Qualcomm® 4G LTE-Advanced/DC-HSPA+/HSPA+/HSPA/UMTS/GNSS, M.2 card Wireless WAN, HUAWEI ME906S, HUAWEI 4G LTE/WCDMA/HSPA/GSM/GPRS/EDGE/GNSS, M.2 card (WE only) 									Compass	3D compass
SIM card	Micro-SIM card slot, optional Verizon LTE (US) or Lenovo Connect (WE) SIM card									Gyroscope	3D gyrometer
Dimensions	WxDxH: 13.11" x 9.02" x 0.66"; 333.0mm x 229.0mm x 16.8mm									Preload	<p>Windows® 7 Professional 64 preinstalled through downgrade rights in Windows 10 Pro 64</p> <ul style="list-style-type: none"> Lenovo Solution Center Lenovo Vantage Product Recovery Rescue and Recovery™ ThinkVantage System Update Adobe® Reader® Microsoft® Office preloaded; purchase a product key to activate McAfee® Live Safe (30-day trial)
Weight	From 3.00 lb (1.36kg)									Limited warranty	<p><i>One of the following, configurable by model:</i></p> <ul style="list-style-type: none"> 1-year depot repair service 3-year/1-yr battery depot repair service 3-year/1-yr battery limited onsite service
Case color	Black									Mil-Spec test	MIL-STD-810G military certification
Case material	Carbon-Fiber Hybrid									Environment	EPEAT™ Gold; ENERGY STAR®; RoHS-compliant

Model	Region	Processor	vPro	Graphics	Memory	Display	Multi-touch	Storage(HDD/SSD)	Optical	WLAN + Bluetooth	WWAN	SIM Card	Dock	Adapter	Camera	Keyboard	Pen	Finger-print Reader	NFC	Battery	Power Adapter	Operating System	Warranty	Global	Ann Date (m/y)
20FQ000RUS	US	i5-6200U	No	Intel HD 520	8GB Soldered	14" FHD (1920x1080) IPS AG	10-point Multi-touch	256GB SSD M.2 SATA3 Opal2	None	Intel 8260 ac, 2x2 + BT4.1	None	None	None	None	720p	Backlit	Pen Pro	Finger-print Reader	None	4-cell (52Wh)	65W	Win10 Pro 64	1-year, Depot	No	02/17
20FQ000SUS	US	i5-6200U	No	Intel HD 520	8GB Soldered	14" WQHD (2560x1440) IPS AG	10-point Multi-touch	512GB SSD M.2	None	Intel 8260 ac, 2x2 + BT4.1	None	None	None	None	720p	Backlit	Pen Pro	Finger-print Reader	None	4-cell (52Wh)	65W	Win10 Pro 64	1-year, Depot	No	01/16
20FQ000YUS	US	i5-6200U	No	Intel HD 520	8GB Soldered	14" FHD (1920x1080) IPS AG	10-point Multi-touch	192GB SSD M.2	None	Intel 8260 ac, 2x2 + BT4.1	None	None	None	None	720p	Backlit	Pen Pro	Finger-print Reader	NFC	4-cell (52Wh)	65W	Win10 Pro 64	3-year, Depot	No	02/16
20FQ0010US	US	i5-6200U	No	Intel HD 520	8GB Soldered	14" FHD (1920x1080) IPS AG	10-point Multi-touch	256GB SSD M.2 SATA3 Opal2	None	Intel 8260 ac, 2x2 + BT4.1	None	None	None	None	720p	Backlit	Pen Pro	Finger-print Reader	NFC	4-cell (52Wh)	65W	Win10 Pro 64	3-year, Depot	No	02/16
20FQ001VUS	US	i7-6500U	No	Intel HD 520	8GB Soldered	14" FHD (1920x1080) IPS AG	10-point Multi-touch	256GB SSD M.2 SATA3 Opal2	None	Intel 8260 ac, 2x2 + BT4.1	None	None	None	None	720p	Backlit	Pen Pro	Finger-print Reader	None	4-cell (52Wh)	65W	Win10 Pro 64	3-year, Depot	No	01/16
20FQ001WUS	US	i7-6500U	No	Intel HD 520	8GB Soldered	14" FHD (1920x1080) IPS AG	10-point Multi-touch	256GB SSD M.2 PCIe NVMe Opal2	None	Intel 8260 ac, 2x2 + BT4.1	None	None	None	None	720p	Backlit	Pen Pro	Finger-print Reader	None	4-cell (52Wh)	65W	Win10 Pro 64	3-year, Depot	No	01/16
20FQ002YUS	US	i7-6600U	vPro	Intel HD 520	16GB Soldered	14" WQHD (2560x1440) IPS AG	10-point Multi-touch	512GB SSD M.2	None	Intel 8260 ac, 2x2 + BT4.1	None	None	None	None	720p	Backlit	Pen Pro	Finger-print Reader	None	4-cell (52Wh)	65W	Win10 Pro 64	3-year, Depot	No	01/16
20FQ0030US	US	i7-6600U	vPro	Intel HD 520	8GB Soldered	14" WQHD (2560x1440) IPS AG	10-point Multi-touch	512GB SSD M.2 PCIe NVMe	None	Intel 18260 ac, 2x2 + BT4.1	None	None	WiGig Dock	None	720p	Backlit	Pen Pro	Finger-print Reader	None	4-cell (52Wh)	65W	Win10 Pro 64	3-year, Depot	No	03/16
20FQ0031US	US	i7-6600U	vPro	Intel HD 520	16GB Soldered	14" WQHD (2560x1440) IPS AG	10-point Multi-touch	512GB SSD M.2 PCIe NVMe	None	Intel 18260 ac, 2x2 + BT4.1	None	None	WiGig Dock	None	720p	Backlit	Pen Pro	Finger-print Reader	None	4-cell (52Wh)	65W	Win10 Pro 64	3-year, Depot	No	03/16
20FQ0032US	US	i7-6600U	vPro	Intel HD 520	16GB Soldered	14" WQHD (2560x1440) IPS AG	10-point Multi-touch	256GB SSD M.2 PCIe NVMe Opal2	None	Intel 8260 ac, 2x2 + BT4.1	None	None	None	None	720p	Backlit	Pen Pro	Finger-print Reader	None	4-cell (52Wh)	65W	Win10 Pro 64	3-year, Depot	No	01/16
20FQ0033US	US	i5-6300U	vPro	Intel HD 520	8GB Soldered	14" FHD (1920x1080) IPS AG	10-point Multi-touch	256GB SSD M.2 SATA3 Opal2	None	Intel 8260 ac, 2x2 + BT4.1	None	None	None	None	720p	Backlit	Pen Pro	Finger-print Reader	None	4-cell (52Wh)	65W	Win10 Pro 64	3-year, Depot	No	01/16
20FQ0034US	US	i7-6600U	vPro	Intel HD 520	8GB Soldered	14" WQHD (2560x1440) IPS AG	10-point Multi-touch	256GB SSD M.2 PCIe NVMe Opal2	None	Intel 18260 ac, 2x2 + BT4.1	None	None	WiGig Dock	None	720p	Backlit	Pen Pro	Finger-print Reader	None	4-cell (52Wh)	65W	Win10 Pro 64	3-year, Depot	No	03/16
20FQ0035US	US	i7-6600U	vPro	Intel HD 520	8GB Soldered	14" WQHD (2560x1440) IPS AG	10-point Multi-touch	512GB SSD M.2	None	Intel 18260 ac, 2x2 + BT4.1	None	None	WiGig Dock	None	720p	Backlit	Pen Pro	Finger-print Reader	None	4-cell (52Wh)	65W	Win10 Pro 64	3-year, Depot	No	03/16
20FQ0036US	US	i7-6600U	vPro	Intel HD 520	8GB Soldered	14" WQHD (2560x1440) IPS AG	10-point Multi-touch	256GB SSD M.2 SATA3 Opal2	None	Intel 8260 ac, 2x2 + BT4.1	None	None	None	None	720p	Backlit	Pen Pro	Finger-print Reader	None	4-cell (52Wh)	65W	Win10 Pro 64	3-year, Depot	No	01/16
20FQ0037US	US	i7-6600U	vPro	Intel HD 520	8GB Soldered	14" WQHD (2560x1440) IPS AG	10-point Multi-touch	512GB SSD M.2	None	Intel 8260 ac, 2x2 + BT4.1	None	None	None	None	720p	Backlit	Pen Pro	Finger-print Reader	None	4-cell (52Wh)	65W	Win10 Pro 64	3-year, Depot	No	01/16
20FQ0038US	US	i7-6600U	vPro	Intel HD 520	8GB Soldered	14" FHD (1920x1080) IPS AG	10-point Multi-touch	256GB SSD M.2 SATA3 Opal2	None	Intel 8260 ac, 2x2 + BT4.1	None	None	None	None	720p	Backlit	Pen Pro	Finger-print Reader	None	4-cell (52Wh)	65W	Win10 Pro 64	3-year, Depot	No	01/16
20FQ0039US	US	i5-6200U	No	Intel HD 520	8GB Soldered	14" FHD (1920x1080) IPS AG	10-point Multi-touch	192GB SSD M.2	None	Intel 8260 ac, 2x2 + BT4.1	None	None	None	None	720p	Backlit	Pen Pro	Finger-print Reader	None	4-cell (52Wh)	65W	Win10 Pro 64	3-year, Depot	No	01/16
20FQ003HUS	US	i5-6300U	vPro	Intel HD 520	8GB Soldered	14" FHD (1920x1080) IPS AG	10-point Multi-touch	240GB SSD M.2 SATA3 Opal2	None	Intel 8260 ac, 2x2 + BT4.1	None	None	None	None	720p	Backlit	Pen Pro	Finger-print Reader	None	4-cell (52Wh)	65W	Win10 Pro 64	3-year, Depot	No	02/16
20FQ003JUS	US	i5-6300U	vPro	Intel HD 520	8GB Soldered	14" WQHD (2560x1440) IPS AG	10-point Multi-touch	512GB SSD M.2	None	Intel 8260 ac, 2x2 + BT4.1	None	None	None	None	720p	Backlit	Pen Pro	Finger-print Reader	None	4-cell (52Wh)	65W	Win10 Pro 64	3-year, Depot	No	02/16
20FQ003KUS	US	i5-6300U	vPro	Intel HD 520	4GB Soldered	14" FHD (1920x1080) IPS AG	10-point Multi-touch	256GB SSD M.2 SATA3 Opal2	None	Intel 8260 ac, 2x2 + BT4.1	None	None	None	None	720p	Backlit	Pen Pro	Finger-print Reader	None	4-cell (52Wh)	65W	Win10 Pro 64	3-year, Depot	No	02/16

Model	Region	Processor	vPro	Graphics	Memory	Display	Multi-touch	Storage(HDD/SSD)	Optical	WLAN + Bluetooth	WWAN	SIM Card	Dock Adapter	Camera	Keyboard	Pen	Finger-print Reader	NFC	Battery	Power Adapter	Operating System	Warranty	Global	Ann Date (m/y)	
20FQ003LUS	US	i7-6600U	vPro	Intel HD 520	16GB Soldered	14" FHD (1920x1080) IPS AG	10-point Multi-touch	512GB SSD M.2 PCIe NVMe	None	Intel 8260 ac, 2x2 + BT4.1	None	None	None	None	720p	Backlit	Pen Pro	Finger-print Reader	None	4-cell (52Wh)	65W	Win10 Pro 64	3-year, Depot	No	02/16
20FQ003MUS	US	i7-6600U	vPro	Intel HD 520	16GB Soldered	14" WQHD (2560x1440) IPS AG	10-point Multi-touch	512GB SSD M.2 PCIe NVMe	None	Intel 8260 ac, 2x2 + BT4.1	None	None	None	None	720p	Backlit	Pen Pro	Finger-print Reader	None	4-cell (52Wh)	65W	Win10 Pro 64	3-year, Depot	No	02/16
20FQ003NUS	US	i5-6200U	No	Intel HD 520	4GB Soldered	14" FHD (1920x1080) IPS AG	10-point Multi-touch	256GB SSD M.2 SATA3 Opal2	None	Intel 8260 ac, 2x2 + BT4.1	None	None	None	None	720p	Backlit	Pen Pro	Finger-print Reader	None	4-cell (52Wh)	65W	Win10 Pro 64	3-year, Depot	No	02/16
20FQ003PUS	US	i5-6300U	vPro	Intel HD 520	8GB Soldered	14" FHD (1920x1080) IPS AG	10-point Multi-touch	180GB SSD M.2 SATA3 Opal2	None	Intel 8260 ac, 2x2 + BT4.1	None	None	None	None	720p	Backlit	Pen Pro	Finger-print Reader	None	4-cell (52Wh)	65W	Win10 Pro 64	3-year, Depot	No	02/16
20FQ003QUS	US	i5-6200U	No	Intel HD 520	8GB Soldered	14" FHD (1920x1080) IPS AG	10-point Multi-touch	256GB SSD M.2 SATA3 Opal2	None	Intel 8260 ac, 2x2 + BT4.1	None	None	None	None	720p	Backlit	Pen Pro	Finger-print Reader	None	4-cell (52Wh)	65W	Win10 Pro 64	3-year, Depot	No	02/16
20FQ003RUS	US	i5-6300U	vPro	Intel HD 520	8GB Soldered	14" FHD (1920x1080) IPS AG	10-point Multi-touch	128GB SSD M.2	None	Intel 8260 ac, 2x2 + BT4.1	None	None	None	None	720p	Backlit	Pen Pro	Finger-print Reader	None	4-cell (52Wh)	65W	Win10 Pro 64	3-year, Depot	No	02/16
20FQ003SUS	US	i7-6600U	vPro	Intel HD 520	16GB Soldered	14" FHD (1920x1080) IPS AG	10-point Multi-touch	256GB SSD M.2 PCIe NVMe Opal2	None	Intel 8260 ac, 2x2 + BT4.1	None	None	None	None	720p	Backlit	Pen Pro	Finger-print Reader	None	4-cell (52Wh)	65W	Win10 Pro 64	3-year, Depot	No	02/16
20FQ003TUS	US	i7-6600U	vPro	Intel HD 520	8GB Soldered	14" FHD (1920x1080) IPS AG	10-point Multi-touch	512GB SSD M.2	None	Intel 8260 ac, 2x2 + BT4.1	None	None	None	None	720p	Backlit	Pen Pro	Finger-print Reader	None	4-cell (52Wh)	65W	Win10 Pro 64	3-year, Depot	No	02/16
20FQ003UUS	US	i7-6600U	vPro	Intel HD 520	16GB Soldered	14" FHD (1920x1080) IPS AG	10-point Multi-touch	256GB SSD M.2 SATA3 Opal2	None	Intel 8260 ac, 2x2 + BT4.1	None	None	None	None	720p	Backlit	Pen Pro	Finger-print Reader	None	4-cell (52Wh)	65W	Win10 Pro 64	3-year, Depot	No	02/16
20FQ003VUS	US	i7-6600U	vPro	Intel HD 520	16GB Soldered	14" FHD (1920x1080) IPS AG	10-point Multi-touch	512GB SSD M.2	None	Intel 8260 ac, 2x2 + BT4.1	None	None	None	None	720p	Backlit	Pen Pro	Finger-print Reader	None	4-cell (52Wh)	65W	Win10 Pro 64	3-year, Depot	No	02/16
20FQ003WUS	US	i5-6300U	vPro	Intel HD 520	8GB Soldered	14" FHD (1920x1080) IPS AG	10-point Multi-touch	192GB SSD M.2	None	Intel 8260 ac, 2x2 + BT4.1	None	None	None	None	720p	Backlit	Pen Pro	Finger-print Reader	None	4-cell (52Wh)	65W	Win10 Pro 64	3-year, Depot	No	02/16
20FQ0054US	US	i7-6600U	vPro	Intel HD 520	16GB Soldered	14" WQHD (2560x1440) IPS AG	10-point Multi-touch	512GB SSD M.2	None	Intel 8260 ac, 2x2 + BT4.1	Sierra EM7455	Verizon	None	None	720p	Backlit	Pen Pro	Finger-print Reader	None	4-cell (52Wh)	65W	Win10 Pro 64	3-year, Depot	No	05/16
20FQ0055US	US	i5-6300U	vPro	Intel HD 520	8GB Soldered	14" WQHD (2560x1440) IPS AG	10-point Multi-touch	256GB SSD M.2 SATA3 Opal2	None	Intel 8260 ac, 2x2 + BT4.1	None	None	None	None	720p	Backlit	Pen Pro	Finger-print Reader	None	4-cell (52Wh)	65W	Win10 Pro 64	3-year, Depot	No	05/16
20FQ0056US	US	i7-6600U	vPro	Intel HD 520	16GB Soldered	14" WQHD (2560x1440) IPS AG	10-point Multi-touch	512GB SSD M.2	None	Intel 18260 ac, 2x2 + BT4.1	None	None	WiGig Dock	None	720p	Backlit	Pen Pro	Finger-print Reader	None	4-cell (52Wh)	65W	Win10 Pro 64	3-year, Depot	No	05/16
20FQ0057US	US	i7-6500U	No	Intel HD 520	8GB Soldered	14" WQHD (2560x1440) IPS AG	10-point Multi-touch	512GB SSD M.2	None	Intel 8260 ac, 2x2 + BT4.1	Sierra EM7455	None	None	None	720p	Backlit	Pen Pro	Finger-print Reader	None	4-cell (52Wh)	65W	Win10 Pro 64	3-year, Depot	No	05/16
20FQ0058US	US	i7-6500U	No	Intel HD 520	8GB Soldered	14" WQHD (2560x1440) IPS AG	10-point Multi-touch	256GB SSD M.2 PCIe NVMe Opal2	None	Intel 8260 ac, 2x2 + BT4.1	Sierra EM7455	None	None	None	720p	Backlit	Pen Pro	Finger-print Reader	None	4-cell (52Wh)	65W	Win10 Pro 64	3-year, Depot	No	05/16
20FQ0059US	US	i5-6200U	No	Intel HD 520	8GB Soldered	14" FHD (1920x1080) IPS AG	10-point Multi-touch	256GB SSD M.2 SATA3 Opal2	None	Intel 8260 ac, 2x2 + BT4.1	Sierra EM7455	None	None	None	720p	Backlit	Pen Pro	Finger-print Reader	None	4-cell (52Wh)	65W	Win10 Pro 64	3-year, Depot	No	05/16
20FQ005AUS	US	i5-6300U	vPro	Intel HD 520	8GB Soldered	14" WQHD (2560x1440) IPS AG	10-point Multi-touch	256GB SSD M.2 SATA3 Opal2	None	Intel 8260 ac, 2x2 + BT4.1	Sierra EM7455	None	None	None	720p	Backlit	Pen Pro	Finger-print Reader	None	4-cell (52Wh)	65W	Win10 Pro 64	3-year, Depot	No	05/16
20FQ005BUS	US	i7-6600U	vPro	Intel HD 520	8GB Soldered	14" WQHD (2560x1440) IPS AG	10-point Multi-touch	256GB SSD M.2 SATA3 Opal2	None	Intel 8260 ac, 2x2 + BT4.1	Sierra EM7455	None	None	None	720p	Backlit	Pen Pro	Finger-print Reader	None	4-cell (52Wh)	65W	Win10 Pro 64	3-year, Depot	No	05/16
20FQ005CUS	US	i7-6500U	No	Intel HD 520	8GB Soldered	14" FHD (1920x1080) IPS AG	10-point Multi-touch	256GB SSD M.2 SATA3 Opal2	None	Intel 8260 ac, 2x2 + BT4.1	Sierra EM7455	None	None	None	720p	Backlit	Pen Pro	Finger-print Reader	None	4-cell (52Wh)	65W	Win10 Pro 64	3-year, Depot	No	05/16

Model	Region	Processor	vPro	Graphics	Memory	Display	Multi-touch	Storage(HDD/SSD)	Optical	WLAN + Bluetooth	WWAN	SIM Card	Dock	Adapter	Camera	Keyboard	Pen	Finger-print Reader	NFC	Battery	Power Adapter	Operating System	Warranty	Global	Ann Date (m/y)
20FQ005DUS	US	i7-6600U	vPro	Intel HD 520	16GB Soldered	14" WQHD (2560x1440) IPS AG	10-point Multi-touch	512GB SSD M.2	None	Intel 8260 ac, 2x2 + BT4.1	Sierra EM7455	None	None	None	720p	Backlit	Pen Pro	Finger-print Reader	None	4-cell (52Wh)	65W	Win10 Pro 64	3-year, Depot	No	05/16
20FQ005EUS	US	i7-6600U	vPro	Intel HD 520	16GB Soldered	14" WQHD (2560x1440) IPS AG	10-point Multi-touch	512GB SSD M.2 PCIe NVMe	None	Intel 8260 ac, 2x2 + BT4.1	Sierra EM7455	None	None	None	720p	Backlit	Pen Pro	Finger-print Reader	None	4-cell (52Wh)	65W	Win10 Pro 64	3-year, Depot	No	05/16
20FQ005XUS	US	i7-6600U	vPro	Intel HD 520	8GB Soldered	14" WQHD (2560x1440) OLED Gloss	10-point Multi-touch	256GB SSD M.2 SATA3 Opal2	None	Intel 8260 ac, 2x2 + BT4.1	None	None	None	None	720p	Backlit	Pen Pro	Finger-print Reader	None	4-cell (56Wh)	65W	Win10 Pro 64	3-year, Depot	No	06/16
20FQ005YUS	US	i5-6300U	vPro	Intel HD 520	8GB Soldered	14" WQHD (2560x1440) OLED Gloss	10-point Multi-touch	256GB SSD M.2 SATA3 Opal2	None	Intel 8260 ac, 2x2 + BT4.1	None	None	None	None	720p	Backlit	Pen Pro	Finger-print Reader	None	4-cell (56Wh)	65W	Win10 Pro 64	3-year, Depot	No	06/16
20FQ0060US	US	i7-6600U	vPro	Intel HD 520	16GB Soldered	14" WQHD (2560x1440) OLED Gloss	10-point Multi-touch	512GB SSD M.2	None	Intel 8260 ac, 2x2 + BT4.1	None	None	None	None	720p	Backlit	Pen Pro	Finger-print Reader	None	4-cell (56Wh)	65W	Win10 Pro 64	3-year, Depot	No	06/16
20FQ0066US	US	i7-6600U	vPro	Intel HD 520	8GB Soldered	14" WQHD (2560x1440) IPS AG	10-point Multi-touch	256GB SSD M.2 SATA3 Opal2	None	Intel 18260 ac, 2x2 + BT4.1	None	None	WiGig Dock	None	720p	Backlit	Pen Pro	Finger-print Reader	None	4-cell (52Wh)	65W	Win10 Pro 64	3-year, Depot	No	07/16
20FQ0067US	US	i5-6300U	vPro	Intel HD 520	8GB Soldered	14" WQHD (2560x1440) IPS AG	10-point Multi-touch	256GB SSD M.2 SATA3 Opal2	None	Intel 18260 ac, 2x2 + BT4.1	None	None	WiGig Dock	None	720p	Backlit	Pen Pro	Finger-print Reader	None	4-cell (52Wh)	65W	Win10 Pro 64	3-year, Depot	No	07/16
20FQ006CUS	US	i5-6200U	No	Intel HD 520	8GB Soldered	14" FHD (1920x1080) IPS AG	10-point Multi-touch	180GB SSD M.2 SATA3 Opal2	None	Intel 8260 ac, 2x2 + BT4.1	None	None	None	None	720p	Backlit	Pen Pro	Finger-print Reader	None	4-cell (52Wh)	65W	Win10 Pro 64	1-year, Depot	No	08/16
20FQ006DUS	US	i5-6200U	No	Intel HD 520	8GB Soldered	14" FHD (1920x1080) IPS AG	10-point Multi-touch	256GB SSD M.2 SATA3 Opal2	None	Intel 8260 ac, 2x2 + BT4.1	None	None	None	None	720p	Backlit	Pen Pro	Finger-print Reader	None	4-cell (52Wh)	65W	Win10 Pro 64	1-year, Depot	No	08/16



ThinkPad Yoga 11e (3rd Gen) Platform Specifications

Product Specifications Reference (PSREF)

Processor	Intel® Celeron® processor, Intel Pentium® Processor, or 6th Generation Intel Core™ i3 Processor	Media reader Ports Control buttons	4-in-1 reader (MMC, SD, SDHC, SDXC) Two USB 3.0, HDMI, Ethernet (RJ-45) Power button, volume control button																																			
	<table border="1"> <thead> <tr> <th>Processor Number</th> <th># of Cores</th> <th># of Threads</th> <th>Base Frequency</th> <th>Burst Frequency</th> <th>Cache</th> <th>Memory Types</th> <th>Processor Graphics</th> </tr> </thead> <tbody> <tr> <td>Cel N3150</td> <td>4</td> <td>4</td> <td>1.6 GHz</td> <td>2.08 GHz</td> <td>2MB</td> <td rowspan="4">DDR3L-1600</td> <td>Intel HD graphics</td> </tr> <tr> <td>Cel N3160</td> <td>4</td> <td>4</td> <td>1.6 GHz</td> <td>2.24 GHz</td> <td>2MB</td> <td>Intel HD graphics</td> </tr> <tr> <td>Pen 4405U</td> <td rowspan="2">2</td> <td rowspan="2">4</td> <td>2.1 GHz</td> <td>-</td> <td>2MB</td> <td>Intel HD graphics 510</td> </tr> <tr> <td>i3-6100U</td> <td>2.3 GHz</td> <td>-</td> <td>3MB</td> <td>Intel HD graphics 520</td> </tr> </tbody> </table>	Processor Number	# of Cores	# of Threads	Base Frequency	Burst Frequency	Cache	Memory Types	Processor Graphics	Cel N3150	4	4	1.6 GHz	2.08 GHz	2MB	DDR3L-1600	Intel HD graphics	Cel N3160	4	4	1.6 GHz	2.24 GHz	2MB	Intel HD graphics	Pen 4405U	2	4	2.1 GHz	-	2MB	Intel HD graphics 510	i3-6100U	2.3 GHz	-	3MB	Intel HD graphics 520	Camera Audio support	HD720p resolution, low light sensitive, fixed focus HD Audio, Realtek® ALC3245 codec / stereo speakers, 2W x 2 / monaural digital microphone, combo audio/microphone jack
Processor Number	# of Cores	# of Threads	Base Frequency	Burst Frequency	Cache	Memory Types	Processor Graphics																															
Cel N3150	4	4	1.6 GHz	2.08 GHz	2MB	DDR3L-1600	Intel HD graphics																															
Cel N3160	4	4	1.6 GHz	2.24 GHz	2MB		Intel HD graphics																															
Pen 4405U	2	4	2.1 GHz	-	2MB		Intel HD graphics 510																															
i3-6100U			2.3 GHz	-	3MB		Intel HD graphics 520																															
Graphics	Intel HD Graphics, Intel HD Graphics 510, or Intel HD Graphics 520 in processor, supports external digital monitor via HDMI™; supports dual independent display; Max resolution: 1920X1080 (HDMI) @30Hz	Keyboard UltraNav™	ThinkPad Windows keyboard, 6-row, multimedia Fn keys Buttonless touchpad below keyboard, multi-touch																																			
Chipset	Intel SoC (System on Chip) platform	Security Security chip vPro Fingerprint reader	Power-on password, hard disk password, supervisor password, security keyhole Trusted Platform Module, TCG 1.2-compliant None None																																			
Memory	2GB, 4GB, or 8GB / PC3-12800 1600MHz DDR3L, one DDR3L SO-DIMM socket	Battery Max battery life ¹⁰ AC adapter	Integrated Lithium Polymer 3-cell (42Wh) MobileMark® 2014: 11.53 hr 45-watt AC adapter																																			
Display	11.6" (295mm) HD (1366x768), glare, LED backlight, IPS 250 nits, 16:9 aspect ratio, 800:1 contrast ratio	Preload	Some: Windows 10 Home 64 Some: Windows 10 Pro 64 • Lenovo Solution Center • Lenovo Companion • Lenovo Setting • Microsoft Office preloaded; purchase a product key to activate • McAfee® LiveSafe™ (30-day trial)																																			
MultiTouch	Yes, support 10 fingers																																					
Hinge	Yoga hinge, 360 degree																																					
Convertible mode	Laptop, tent, stand and tablet																																					
Pen	Some: Active pen, batteries required																																					
Storage	M.2 Solid State Drive (SSD), SATA 6.0Gb/s	Limited warranty ¹²	One of the following, configurable by model: • 1-year depot repair service • 3-year/1-yr battery depot repair service (US only)																																			
Optical	None	Mil-Spec test	MIL-STD-810G military certification																																			
Ethernet	Realtek RTL8111GUS-CG Gigabit Network Connection	Environment	EPEAT™ Gold (US only); ENERGY STAR® 6.1; RoHS-compliant																																			
WLAN ⁴	One of the following, configurable by model: • 11ac+BT, Intel Dual Band Wireless-AC 3165, 1x1, M.2 card • 11ac+BT, Intel Dual Band Wireless-AC 7265, 2x2, M.2 card																																					
Bluetooth™	Bluetooth 4.0 wireless, integrated in Wi-Fi + Bluetooth combo adapter																																					
WWAN	None																																					
Dimensions ³	WxDxH: 11.81" x 8.27" x 0.90"; 300mm x 210mm x 22.9mm																																					
Weight ²	from 3.5 lb (1.59kg)																																					
Case color	Display cover: Graphite Black or Silver; Bottom: Graphite Black																																					
Case material	Display cover: PC+40%GF+TPU; Bottom: PCC																																					

ThinkPad Yoga 11e (3rd Gen) - TopSeller - 20GA

Product Specifications Reference (PSREF)

Model	Region	Processor	Graphics	Memory	Display	Multi-touch	Storage	Optical	WLAN + Bluetooth	Color	Camera	Pen	Finger-print Reader	Battery	Power Adapter	Operating System	Warranty	Global	Ann Date (m/y)
20GA000KUS	US	Celeron N3150	Intel HD	4GBx1	11.6" HD (1366x768) IPS	10-point Multi-touch	128GB SSD	None	Intel 7265 ac, 2x2 + BT4.0	Black	720p	None	None	3-cell (42Wh)	45W	Windows 10 Pro 64	1-year, Depot	No	03/16
20GA000LUS	US	Celeron N3150	Intel HD	8GBx1	11.6" HD (1366x768) IPS	10-point Multi-touch	128GB SSD	None	Intel 7265 ac, 2x2 + BT4.0	Black	720p	None	None	3-cell (42Wh)	45W	Windows 10 Pro 64	1-year, Depot	No	03/16
20GA000MUS	US	i3-6100U	Intel HD 520	8GBx1	11.6" HD (1366x768) IPS	10-point Multi-touch	128GB SSD	None	Intel 7265 ac, 2x2 + BT4.0	Black	720p	None	None	3-cell (42Wh)	45W	Windows 10 Pro 64	1-year, Depot	No	03/16
20GA000NUS	US	i3-6100U	Intel HD 520	8GBx1	11.6" HD (1366x768) IPS	10-point Multi-touch	256GB SSD Opal2	None	Intel 7265 ac, 2x2 + BT4.0	Black	720p	None	None	3-cell (42Wh)	45W	Windows 10 Pro 64	1-year, Depot	No	03/16
20GA000QUS	US	i3-6100U	Intel HD 520	8GBx1	11.6" HD (1366x768) IPS	10-point Multi-touch	192GB SSD	None	Intel 7265 ac, 2x2 + BT4.0	Black	720p	None	None	3-cell (42Wh)	45W	Windows 10 Pro 64	1-year, Depot	No	03/16
20GA000YUS	US	i3-6100U	Intel HD 520	4GBx1	11.6" HD (1366x768) IPS	10-point Multi-touch	192GB SSD	None	Intel 7265 ac, 2x2 + BT4.0	Black	720p	None	None	3-cell (42Wh)	45W	Windows 10 Pro 64	1-year, Depot	No	03/16
20GA001EUS	US	Celeron N3160	Intel HD	8GBx1	11.6" HD (1366x768) IPS	10-point Multi-touch	128GB SSD	None	Intel 7265 ac, 2x2 + BT4.0	Black	720p	None	None	3-cell (42Wh)	45W	Windows 10 Pro 64	1-year, Depot	No	09/16
20GA001FUS	US	Celeron N3160	Intel HD	4GBx1	11.6" HD (1366x768) IPS	10-point Multi-touch	128GB SSD	None	Intel 7265 ac, 2x2 + BT4.0	Black	720p	None	None	3-cell (42Wh)	45W	Windows 10 Pro 64	1-year, Depot	No	09/16



ThinkPad Yoga 11e (3rd Gen) Chromebook Platform Specifications

Product Specifications Reference (PSREF)

Processor	Intel® Celeron® processor								Dimensions ³	WxDxH: 11.81" x 8.27" x 0.88"; 300mm x 210mm x 22.3mm
	Processor Number	# of Cores	# of Threads	Base Frequency	Burst Frequency	Cache	Memory Types	Processor Graphics	Weight ²	from 3.3 lb (1.50kg)
	Cel N3150	4	4	1.6 GHz	2.08 GHz	2MB	LPDDR3-1600	Intel HD graphics	Case color	Display cover: Graphite Black or Silver; Bottom: Graphite Black
									Case material	Display cover: PC+40%GF+TPU; Bottom: PCC
Graphics	Intel HD Graphics in processor, supports external digital monitor via HDMI™; supports dual independent display; Max resolution: 1920X1080 (HDMI) @30Hz								Media reader	4-in-1 reader (MMC, SD, SDHC, SDXC)
									Ports	Two USB 3.0 (one Always On), HDMI
									Control buttons	Power button, volume control button
Chipset	Intel SoC (System on Chip) platform								Camera	HD720p resolution, low light sensitive, fixed focus
Memory	2GB or 4GB / 1600MHz LPDDR3 / soldered to systemboard, no sockets								Audio support	Realtek® ALC5650 codec / stereo speakers, 2W x 2 / monaural digital microphone, combo audio/microphone jack
Display	11.6" (295mm) HD (1366x768), glare, LED backlight, IPS 200 nits, 16:9 aspect ratio, 800:1 contrast ratio								Keyboard	ThinkPad Chrome keyboard, 6-row, multimedia Fn keys
MultiTouch	Yes, support 10 fingers								UltraNav™	Buttonless touchpad below keyboard, multi-touch
Hinge	Yoga hinge, 360 degree								Security	Security keyhole
Convertible mode	Laptop, tent, stand and tablet								Security chip	Trusted Platform Module, TCG 1.2-compliant
Pen	None								vPro	None
Storage	16GB eMMC (embedded Multi Media Card) flash memory on board								Fingerprint reader	None
Optical	None								Battery	Integrated Lithium Polymer 3-cell (42Wh)
Ethernet	None								Max battery life ¹⁰	Up to 12 hr
WLAN ⁴	11ac+BT, Intel Dual Band Wireless-AC 7265, 2x2, M.2 card								AC adapter	45-watt AC adapter
Bluetooth™	Bluetooth 4.0 wireless, integrated in Wi-Fi + Bluetooth combo adapter								Preload	Google Chrome OS
WWAN	None								Limited warranty ¹²	1-year depot repair service
									Mil-Spec test	MIL-STD-810G military certification
									Environment	EPEAT™ Gold (US only); ENERGY STAR® 6.1; RoHS-compliant

ThinkPad Yoga 11e (3rd Gen) Chromebook - TopSeller - 20GE

Product Specifications Reference (PSREF)

Model	Region	Processor	Graphics	Memory	Display	Multi-touch	Storage	Optical	WLAN + Bluetooth	Color	Camera	Pen	Finger-print Reader	Battery	Power Adapter	Operating System	Warranty	Global	Ann Date (m/y)
20GE0002US	US	Celeron N3150	Intel HD	4GBx1	11.6" HD (1366x768) IPS	10-point Multi-touch	16GB eMMC	None	Intel 7265 ac, 2x2 + BT4.0	Black	720p	None	None	3-cell (42Wh)	45W	Chrome OS	1-year, Depot	No	03/16
20GE0003US	US	Celeron N3160	Intel HD	4GBx1	11.6" HD (1366x768) IPS	10-point Multi-touch	16GB eMMC	None	Intel 7265 ac, 2x2 + BT4.0	Black	720p	None	None	3-cell (42Wh)	45W	Chrome OS	1-year, Depot	No	10/16

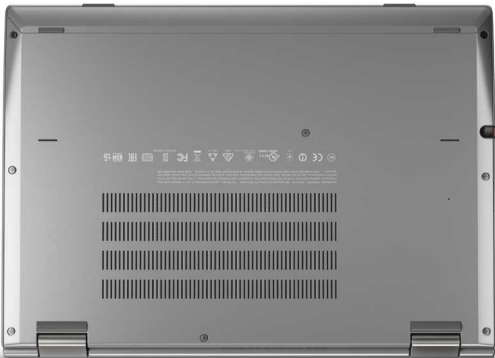

ThinkPad Yoga 260 Platform Specifications

Product Specifications Reference (PSREF)

Processor	6th Generation Intel® Core™ i3 / i5 / i7 Processor								Smart Card Reader ExpressCard Media reader Ports WiGig dock Camera Audio support	<i>Some:</i> Smart Card Reader None Micro SD, supports UHS-I SD card Two USB 3.0 (one Always On), Mini DisplayPort, HDMI, Onelink+ connector, combo audio / microphone jack <i>Optional:</i> WiGig dock, mutually exclusive with WWAN HD720p resolution, fixed focus HD Audio, Conexant® CX11852 codec, Dolby® Home Theater® v4 / stereo speakers, 2W x 2 / dual array microphone, combo audio / microphone jack
	Processor Number	# of Cores	# of Threads	Base Frequency	Max Turbo Frequency	Cache	Memory Types	Processor Graphics		
	i3-6100U	2	4	2.3 GHz	-	3MB	DDR4-2133	Intel HD Graphics 520		
	i5-6200U			2.3 GHz	2.8 GHz	3MB				
	i5-6300U			2.4 GHz	3.0 GHz	3MB				
	i7-6500U			2.5 GHz	3.1 GHz	4MB				
i7-6600U	2.6 GHz			3.4 GHz	4MB					
Graphics	Intel HD Graphics 520 in processor only, supports external digital monitor via HDMI, Mini DisplayPort; supports dual independent display Max resolution: 3840x2160 (Mini DisplayPort) @60Hz 4096x2160 (HDMI) @24Hz								Keyboard UltraNav™ ThinkLight™	6-row, LED backlit, spill-resistant, multimedia Fn keys TrackPoint® pointing device and multi-touch with 3+2 buttons click pad None
Chipset Memory	Intel SoC (System on Chip) platform 16GB max / 2133MHz DDR4, one DDR4 SO-DIMM socket (None WWAN models), or 8GB 2133MHz DDR4 soldered to systemboard for WWAN models								Security Security chip vPro Fingerprint reader NFC	Power-on password, hard disk password, supervisor password, security keyhole Discrete TPM 1.2 TCG Certified and Firmware TPM 2.0 integrated in chipset <i>Some:</i> Intel vPro Technology <i>Some:</i> Touch style fingerprint reader on the keyboard bezel <i>Some:</i> Near Field Communication
Display	<i>Some:</i> 12.5" (317.5mm) HD (1366x768) color, anti-glare, LED backlight, IPS 300 nits, 16:9 aspect ratio, IPS <i>Some:</i> 12.5" (317.5mm) FHD (1920x1080) color, anti-glare, LED backlight, IPS 300 nits, 16:9 aspect ratio, IPS								Battery type Battery life AC adapter	Li-Polymer 4-cell (44Wh) Up to 10.0 hr <i>Some:</i> 45-watt AC adapter <i>Some:</i> 65-watt AC adapter
Multi-touch Hinge Convert-mode Pen	Supports 10-finger gesture Yoga hinge, 360 degree Laptop, tent, stand and tablet <i>Some:</i> ThinkPad Pen Pro, active pen for multi-touch display								Light sensor G-sensor/ eCompass Gyroscope	Ambient Light Sensor 3D accelerometer and 3D magnetometer 3D compass 3D gyrometer
Storage	<i>Some:</i> M.2 SSD / SATA 6.0Gb/s <i>Some:</i> M.2 SSD / PCIe NVMe 32Gb/s								Preload	<i>Some:</i> Windows® 7 Professional 64 <i>Some:</i> Windows® 7 Professional 64 preinstalled through downgrade rights in Windows 10 Pro 64 <ul style="list-style-type: none"> Lenovo Solution Center Lenovo SHAREit Lenovo Vantage Product Recovery Rescue and Recovery™ ThinkVantage System Update PC Device Stage Adobe® Reader® Microsoft® Office preloaded; purchase a product key to activate McAfee® Live Safe (30-day trial)
Optical	None								Limited warranty	1-year - depot repair service / service upgrades available 3-year - depot repair service / service upgrades available 3-year - onsite repair service / service upgrades available
Ethernet	Gigabit Ethernet via optional Ethernet (RJ-45) adapter (by native Intel Ethernet Connection I219-V (Non-vPro) or I219-LM (vPro))								Mil-Spec test	MIL-STD-810G military certification
WLAN	<i>One of the following, configurable by model (WiGig is mutually exclusive with WWAN):</i> <ul style="list-style-type: none"> <i>BCM:</i> Broadcom Wireless-AC, 2x2, Wi-Fi + Bluetooth combo adapter, M.2 Card <i>no vPro:</i> Intel Dual Band Wireless-AC 8260, 2x2, Wi-Fi + BT, M.2 Card <i>vPro:</i> Intel Dual Band Wireless-AC 8260 with vPro, 2x2, Wi-Fi + BT, M.2 Card <i>WiGig:</i> WiGig™ +1 1AC+BT, Intel Tri-Band Wireless-AC 18260, 2x2 WLAN, 1x1 WiGig, M.2 Card <i>*WiGig adapter is only available in selected countries*</i>								Environment	EPEAT™ Gold; ENERGY STAR®; RoHS-compliant
Bluetooth™	Bluetooth wireless, integrated in Wi-Fi + Bluetooth combo adapter									
WWAN (optional)	Wireless WAN, Sierra Wireless EM7455, Qualcomm® 4G LTE-Advanced/DC-HSPA+/HSPA+/HSPA/UMTS/GNSS, M.2 card <i>*WWAN models are only available with i5, i7 processors, 8GB soldered to systemboard memory and FHD display*</i>									
SIM card	Micro-SIM card slot, optional Lenovo Connect (WE) SIM card									
Dimensions	12.5" (WxDxH): 12.20" x 8.66" x 0.70" (309.9mm x 220mm x 17.8mm)									
Weight	From 2.90 lb (1.32kg)									
Case color	Midnight black or silver									
Case Material	Carbon-Fiber Hybrid									

Model	Region	Processor	vPro	Graphics	Memory	Display	Multi-touch	Storage	WLAN + Bluetooth	WWAN	SIM Card	Smart Card Reader	Dock	Adapter	Color	Case Material	Camera	Keyboard	Pen	Fingerprint Reader	NFC	Battery	Power Adapter	Operating System	Warranty	Ann Date (m/y)
20FD0000US	US	i5-6200U	No	Intel HD 520	4GBx1	12.5" HD (1366x768) IPS	10-point Multi-touch	192GB SSD	Intel 8260 ac, 2x2 + BT4.1	None	None	None	None	None	Black Carbon	Carbon	720p	Backlit	Pen Pro	Fingerprint Reader	None	4-cell (44Wh)	45W	Win10 Pro 64	1-year, Depot	11/15
20FD0001US	US	i3-6100U	No	Intel HD 520	4GBx1	12.5" HD (1366x768) IPS	10-point Multi-touch	128GB SSD	Intel 8260 ac, 2x2 + BT4.1	None	None	None	None	None	Black Carbon	Carbon	720p	Backlit	Pen Pro	Fingerprint Reader	None	4-cell (44Wh)	45W	Win10 Pro 64	1-year, Depot	11/15
20FD0002US	US	i5-6200U	No	Intel HD 520	4GBx1	12.5" FHD (1920x1080) IPS	10-point Multi-touch	192GB SSD	Intel 8260 ac, 2x2 + BT4.1	None	None	None	None	None	Black Carbon	Carbon	720p	Backlit	Pen Pro	Fingerprint Reader	None	4-cell (44Wh)	45W	Win10 Pro 64	1-year, Depot	11/15
20FD0003US	US	i3-6100U	No	Intel HD 520	4GBx1	12.5" FHD (1920x1080) IPS	10-point Multi-touch	128GB SSD	Intel 8260 ac, 2x2 + BT4.1	None	None	None	None	None	Black Carbon	Carbon	720p	Backlit	Pen Pro	Fingerprint Reader	None	4-cell (44Wh)	45W	Win10 Pro 64	1-year, Depot	11/15
20FD0004US	US	i5-6200U	No	Intel HD 520	8GBx1	12.5" FHD (1920x1080) IPS	10-point Multi-touch	256GB SSD Opal2	Intel 8260 ac, 2x2 + BT4.1	None	None	None	None	None	Black Carbon	Carbon	720p	Backlit	Pen Pro	Fingerprint Reader	None	4-cell (44Wh)	45W	Win10 Pro 64	1-year, Depot	11/15
20FD0029US	US	i7-6500U	No	Intel HD 520	16GBx1	12.5" FHD (1920x1080) IPS	10-point Multi-touch	512GB SSD	Intel 8260 ac, 2x2 + BT4.1	None	None	None	None	None	Black Carbon	Carbon	720p	Backlit	Pen Pro	Fingerprint Reader	None	4-cell (44Wh)	45W	Win10 Pro 64	1-year, Depot	01/16
20FD002AUS	US	i5-6200U	No	Intel HD 520	8GBx1	12.5" FHD (1920x1080) IPS	10-point Multi-touch	192GB SSD	Intel 8260 ac, 2x2 + BT4.1	None	None	None	None	None	Black Carbon	Carbon	720p	Backlit	Pen Pro	Fingerprint Reader	None	4-cell (44Wh)	45W	Win10 Pro 64	1-year, Depot	01/16
20FD002BUS	US	i5-6200U	No	Intel HD 520	8GBx1	12.5" FHD (1920x1080) IPS	10-point Multi-touch	180GB SSD Opal2	Intel 8260 ac, 2x2 + BT4.1	None	None	None	None	None	Black Carbon	Carbon	720p	Backlit	Pen Pro	Fingerprint Reader	None	4-cell (44Wh)	45W	Win10 Pro 64	1-year, Depot	01/16
20FD002DUS	US	i5-6200U	No	Intel HD 520	8GBx1	12.5" HD (1366x768) IPS	10-point Multi-touch	192GB SSD	Intel 8260 ac, 2x2 + BT4.1	None	None	None	None	None	Black Carbon	Carbon	720p	Backlit	Pen Pro	Fingerprint Reader	None	4-cell (44Wh)	45W	Win10 Pro 64	1-year, Depot	01/16
20FD002EUS	US	i5-6300U	vPro	Intel HD 520	8GBx1	12.5" FHD (1920x1080) IPS	10-point Multi-touch	192GB SSD	Intel 8260 ac, 2x2 + BT4.1	None	None	None	None	None	Black Carbon	Carbon	720p	Backlit	Pen Pro	Fingerprint Reader	None	4-cell (44Wh)	45W	Win10 Pro 64	1-year, Depot	01/16
20FD002FUS	US	i7-6600U	vPro	Intel HD 520	16GBx1	12.5" FHD (1920x1080) IPS	10-point Multi-touch	512GB SSD	Intel 8260 ac, 2x2 + BT4.1	None	None	None	None	None	Black Carbon	Carbon	720p	Backlit	Pen Pro	Fingerprint Reader	None	4-cell (44Wh)	45W	Win10 Pro 64	1-year, Depot	01/16
20FD002GUS	US	i5-6300U	vPro	Intel HD 520	8GBx1	12.5" FHD (1920x1080) IPS	10-point Multi-touch	180GB SSD Opal2	Intel 8260 ac, 2x2 + BT4.1	None	None	None	None	None	Black Carbon	Carbon	720p	Backlit	Pen Pro	Fingerprint Reader	None	4-cell (44Wh)	45W	Win10 Pro 64	1-year, Depot	01/16
20FD002HUS	US	i5-6300U	vPro	Intel HD 520	8GBx1	12.5" FHD (1920x1080) IPS	10-point Multi-touch	256GB SSD Opal2	Intel 8260 ac, 2x2 + BT4.1	None	None	None	None	None	Black Carbon	Carbon	720p	Backlit	Pen Pro	Fingerprint Reader	None	4-cell (44Wh)	45W	Win10 Pro 64	1-year, Depot	01/16
20FD002JUS	US	i5-6300U	vPro	Intel HD 520	8GBx1	12.5" HD (1366x768) IPS	10-point Multi-touch	192GB SSD	Intel 8260 ac, 2x2 + BT4.1	None	None	None	None	None	Black Carbon	Carbon	720p	Backlit	Pen Pro	Fingerprint Reader	None	4-cell (44Wh)	45W	Win10 Pro 64	1-year, Depot	01/16
20FD002KUS	US	i7-6600U	vPro	Intel HD 520	8GBx1	12.5" FHD (1920x1080) IPS	10-point Multi-touch	256GB SSD Opal2	Intel 8260 ac, 2x2 + BT4.1	None	None	None	None	None	Black Carbon	Carbon	720p	Backlit	Pen Pro	Fingerprint Reader	None	4-cell (44Wh)	45W	Win10 Pro 64	1-year, Depot	01/16
20FD002LUS	US	i5-6300U	vPro	Intel HD 520	8GBx1	12.5" FHD (1920x1080) IPS	10-point Multi-touch	512GB SSD	Intel 18260 ac, 2x2 + BT4.1	None	None	None	WiGig Dock	None	Black Carbon	Carbon	720p	Backlit	Pen Pro	Fingerprint Reader	None	4-cell (44Wh)	45W	Win10 Pro 64	1-year, Depot	04/16
20FD002MUS	US	i7-6600U	vPro	Intel HD 520	8GBx1	12.5" FHD (1920x1080) IPS	10-point Multi-touch	256GB SSD Opal2	Intel 18260 ac, 2x2 + BT4.1	None	None	None	WiGig Dock	None	Black Carbon	Carbon	720p	Backlit	Pen Pro	Fingerprint Reader	None	4-cell (44Wh)	45W	Win10 Pro 64	1-year, Depot	04/16
20FD002NUS	US	i5-6300U	vPro	Intel HD 520	8GBx1	12.5" FHD (1920x1080) IPS	10-point Multi-touch	256GB SSD Opal2	Intel 18260 ac, 2x2 + BT4.1	None	None	None	WiGig Dock	None	Black Carbon	Carbon	720p	Backlit	Pen Pro	Fingerprint Reader	None	4-cell (44Wh)	45W	Win10 Pro 64	1-year, Depot	04/16
20FD002PUS	US	i5-6300U	vPro	Intel HD 520	8GBx1	12.5" FHD (1920x1080) IPS	10-point Multi-touch	192GB SSD	Intel 18260 ac, 2x2 + BT4.1	None	None	None	WiGig Dock	None	Black Carbon	Carbon	720p	Backlit	Pen Pro	Fingerprint Reader	None	4-cell (44Wh)	45W	Win10 Pro 64	1-year, Depot	04/16
20FD002QUS	US	i7-6600U	vPro	Intel HD 520	8GBx1	12.5" FHD (1920x1080) IPS	10-point Multi-touch	512GB SSD	Intel 18260 ac, 2x2 + BT4.1	None	None	None	WiGig Dock	None	Black Carbon	Carbon	720p	Backlit	Pen Pro	Fingerprint Reader	None	4-cell (44Wh)	45W	Win10 Pro 64	1-year, Depot	04/16

Model	Region	Processor	vPro	Graphics	Memory	Display	Multi-touch	Storage	WLAN + Bluetooth	WWAN	SIM Card	Smart Card Reader	Dock Adapter	Color	Case Material	Camera	Keyboard	Pen	Fingerprint Reader	NFC	Battery	Power Adapter	Operating System	Warranty	Ann Date (m/y)
20FD003HUS	US	i7-6600U	vPro	Intel HD 520	8GB Soldered	12.5" FHD (1920x1080) IPS	10-point Multi-touch	256GB SSD Opal2	Intel 8260 ac, 2x2 + BT4.1	Sierra EM7455	None	None	None	None	Black Carbon	720p	Backlit	Pen Pro	Fingerprint Reader	NFC	4-cell (44Wh)	45W	Win10 Pro 64	3-year, Depot	05/16
20FD003JUS	US	i7-6600U	vPro	Intel HD 520	8GB Soldered	12.5" FHD (1920x1080) IPS	10-point Multi-touch	512GB SSD	Intel 8260 ac, 2x2 + BT4.1	Sierra EM7455	None	None	None	None	Black Carbon	720p	Backlit	Pen Pro	Fingerprint Reader	NFC	4-cell (44Wh)	45W	Win10 Pro 64	3-year, Depot	05/16
20FD003KUS	US	i5-6300U	vPro	Intel HD 520	8GB Soldered	12.5" FHD (1920x1080) IPS	10-point Multi-touch	256GB SSD Opal2	Intel 8260 ac, 2x2 + BT4.1	Sierra EM7455	None	None	None	None	Black Carbon	720p	Backlit	Pen Pro	Fingerprint Reader	NFC	4-cell (44Wh)	45W	Win10 Pro 64	3-year, Depot	05/16
20FD003RUS	US	i5-6200U	No	Intel HD 520	8GBx1	12.5" HD (1366x768) IPS	10-point Multi-touch	180GB SSD Opal2	Intel 8260 ac, 2x2 + BT4.1	None	None	None	None	None	Black Carbon	720p	Backlit	Pen Pro	Fingerprint Reader	None	4-cell (44Wh)	45W	Win10 Pro 64	1-year, Depot	08/16
20FD003SUS	US	i7-6600U	vPro	Intel HD 520	8GB Soldered	12.5" FHD (1920x1080) IPS	10-point Multi-touch	512GB SSD	Intel 8260 ac, 2x2 + BT4.1	Sierra EM7455	None	None	None	None	Black Carbon	720p	Backlit	Pen Pro	Fingerprint Reader	None	4-cell (44Wh)	45W	Win10 Pro 64	3-year, Depot	11/16
20FD003TUS	US	i5-6300U	vPro	Intel HD 520	8GB Soldered	12.5" FHD (1920x1080) IPS	10-point Multi-touch	256GB SSD Opal2	Intel 8260 ac, 2x2 + BT4.1	Sierra EM7455	None	None	None	None	Black Carbon	720p	Backlit	Pen Pro	Fingerprint Reader	None	4-cell (44Wh)	45W	Win10 Pro 64	3-year, Depot	11/16
20FD003UUS	US	i7-6600U	vPro	Intel HD 520	8GB Soldered	12.5" FHD (1920x1080) IPS	10-point Multi-touch	256GB SSD Opal2	Intel 8260 ac, 2x2 + BT4.1	Sierra EM7455	None	None	None	None	Black Carbon	720p	Backlit	Pen Pro	Fingerprint Reader	None	4-cell (44Wh)	45W	Win10 Pro 64	3-year, Depot	11/16
20FDA01WUS	US	i5-6200U	No	Intel HD 520	8GBx1	12.5" HD (1366x768) IPS	10-point Multi-touch	256GB SSD Opal2	Intel 8260 ac, 2x2 + BT4.1	None	None	None	None	None	Black Carbon	720p	Backlit	Pen Pro	Fingerprint Reader	None	4-cell (44Wh)	45W	Win10 Pro 64	1-year, Depot	08/16

ThinkPad Yoga 260 - TopSeller - 20FE

Product Specifications Reference (PSREF)

Model	Region	Processor	vPro	Graphics	Memory	Display	Multi-touch	Storage	WLAN + Bluetooth	WWAN	SIM Card	Smart Card Reader	Dock Adapter	Color	Case Material	Camera	Keyboard	Pen	Fingerprint Reader	NFC	Battery	Power Adapter	Operating System	Warranty	Ann Date (m/y)
20FE0057US	US	i7-6600U	vPro	Intel HD 520	8GB Soldered	12.5" FHD (1920x1080) IPS	10-point Multi-touch	256GB SSD Opal2	Intel 8260 ac, 2x2 + BT4.1	Sierra EM7455	None	None	None	None	Black Carbon	720p	Backlit	Pen Pro	Fingerprint Reader	NFC	4-cell (44Wh)	45W	Win10 Pro 64	3-year, Depot	04/16
20FE0058US	US	i7-6600U	vPro	Intel HD 520	8GB Soldered	12.5" FHD (1920x1080) IPS	10-point Multi-touch	512GB SSD	Intel 8260 ac, 2x2 + BT4.1	Sierra EM7455	None	None	None	None	Black Carbon	720p	Backlit	Pen Pro	Fingerprint Reader	NFC	4-cell (44Wh)	45W	Win10 Pro 64	3-year, Depot	04/16
20FE0059US	US	i5-6300U	vPro	Intel HD 520	8GB Soldered	12.5" FHD (1920x1080) IPS	10-point Multi-touch	256GB SSD Opal2	Intel 8260 ac, 2x2 + BT4.1	Sierra EM7455	None	None	None	None	Black Carbon	720p	Backlit	Pen Pro	Fingerprint Reader	NFC	4-cell (44Wh)	45W	Win10 Pro 64	3-year, Depot	04/16

ThinkPad Yoga 260 - TopSeller - 20GS

Product Specifications Reference (PSREF)

Model	Region	Processor	vPro	Graphics	Memory	Display	Multi-touch	Storage	WLAN + Bluetooth	WWAN	SIM Card	Smart Card Reader	Dock Adapter	Color	Case Material	Camera	Keyboard	Pen	Fingerprint Reader	NFC	Battery	Power Adapter	Operating System	Warranty	Ann Date (m/y)
20GS0000US	US	i5-6200U	No	Intel HD 520	4GBx1	12.5" HD (1366x768) IPS	10-point Multi-touch	192GB SSD	Intel 8260 ac, 2x2 + BT4.1	None	None	None	None	None	Silver Carbon	720p	Backlit	Pen Pro	None	None	4-cell (44Wh)	45W	Win10 Pro 64	1-year, Depot	01/16
20GS0001US	US	i3-6100U	No	Intel HD 520	4GBx1	12.5" HD (1366x768) IPS	10-point Multi-touch	128GB SSD	Intel 8260 ac, 2x2 + BT4.1	None	None	None	None	None	Silver Carbon	720p	Backlit	Pen Pro	None	None	4-cell (44Wh)	45W	Win10 Pro 64	1-year, Depot	01/16
20GS0002US	US	i7-6500U	No	Intel HD 520	8GBx1	12.5" FHD (1920x1080) IPS	10-point Multi-touch	256GB SSD Opal2	Intel 8260 ac, 2x2 + BT4.1	None	None	None	None	None	Silver Carbon	720p	Backlit	Pen Pro	None	None	4-cell (44Wh)	45W	Win10 Pro 64	1-year, Depot	01/16
20GS0003US	US	i7-6500U	No	Intel HD 520	16GBx1	12.5" FHD (1920x1080) IPS	10-point Multi-touch	512GB SSD	Intel 8260 ac, 2x2 + BT4.1	None	None	None	None	None	Silver Carbon	720p	Backlit	Pen Pro	None	None	4-cell (44Wh)	45W	Win10 Pro 64	1-year, Depot	01/16
20GS0004US	US	i5-6200U	No	Intel HD 520	4GBx1	12.5" FHD (1920x1080) IPS	10-point Multi-touch	192GB SSD	Intel 8260 ac, 2x2 + BT4.1	None	None	None	None	None	Silver Carbon	720p	Backlit	Pen Pro	None	None	4-cell (44Wh)	45W	Win10 Pro 64	1-year, Depot	01/16
20GS0005US	US	i5-6200U	No	Intel HD 520	8GBx1	12.5" FHD (1920x1080) IPS	10-point Multi-touch	256GB SSD Opal2	Intel 8260 ac, 2x2 + BT4.1	None	None	None	None	None	Silver Carbon	720p	Backlit	Pen Pro	None	None	4-cell (44Wh)	45W	Win10 Pro 64	1-year, Depot	01/16
20GS0006US	US	i3-6100U	No	Intel HD 520	4GBx1	12.5" FHD (1920x1080) IPS	10-point Multi-touch	192GB SSD	Intel 8260 ac, 2x2 + BT4.1	None	None	None	None	None	Silver Carbon	720p	Backlit	Pen Pro	None	None	4-cell (44Wh)	45W	Win10 Pro 64	1-year, Depot	01/16
20GS0007US	US	i5-6200U	No	Intel HD 520	8GBx1	12.5" HD (1366x768) IPS	10-point Multi-touch	192GB SSD	Intel 8260 ac, 2x2 + BT4.1	None	None	None	None	None	Silver Carbon	720p	Backlit	Pen Pro	None	None	4-cell (44Wh)	45W	Win10 Pro 64	1-year, Depot	01/16
20GS0008US	US	i5-6300U	vPro	Intel HD 520	8GBx1	12.5" FHD (1920x1080) IPS	10-point Multi-touch	192GB SSD	Intel 8260 ac, 2x2 + BT4.1	None	None	None	None	None	Silver Carbon	720p	Backlit	Pen Pro	None	None	4-cell (44Wh)	45W	Win10 Pro 64	1-year, Depot	01/16
20GS0009US	US	i5-6300U	vPro	Intel HD 520	8GBx1	12.5" FHD (1920x1080) IPS	10-point Multi-touch	180GB SSD Opal2	Intel 8260 ac, 2x2 + BT4.1	None	None	None	None	None	Silver Carbon	720p	Backlit	Pen Pro	None	None	4-cell (44Wh)	45W	Win10 Pro 64	1-year, Depot	01/16
20GS000AUS	US	i5-6300U	vPro	Intel HD 520	8GBx1	12.5" FHD (1920x1080) IPS	10-point Multi-touch	256GB SSD Opal2	Intel 8260 ac, 2x2 + BT4.1	None	None	None	None	None	Silver Carbon	720p	Backlit	Pen Pro	None	None	4-cell (44Wh)	45W	Win10 Pro 64	1-year, Depot	01/16
20GS000BUS	US	i7-6600U	vPro	Intel HD 520	16GBx1	12.5" FHD (1920x1080) IPS	10-point Multi-touch	512GB SSD	Intel 8260 ac, 2x2 + BT4.1	None	None	None	None	None	Silver Carbon	720p	Backlit	Pen Pro	None	None	4-cell (44Wh)	45W	Win10 Pro 64	1-year, Depot	01/16
20GS000CUS	US	i7-6600U	vPro	Intel HD 520	8GBx1	12.5" FHD (1920x1080) IPS	10-point Multi-touch	256GB SSD Opal2	Intel 8260 ac, 2x2 + BT4.1	None	None	None	None	None	Silver Carbon	720p	Backlit	Pen Pro	None	None	4-cell (44Wh)	45W	Win10 Pro 64	1-year, Depot	01/16
20GS000FUS	US	i5-6200U	No	Intel HD 520	8GBx1	12.5" HD (1366x768) IPS	10-point Multi-touch	180GB SSD Opal2	Intel 8260 ac, 2x2 + BT4.1	None	None	None	None	None	Silver Carbon	720p	Backlit	Pen Pro	None	None	4-cell (44Wh)	45W	Win10 Pro 64	1-year, Depot	08/16
20GS000GUS	US	i5-6200U	No	Intel HD 520	8GBx1	12.5" HD (1366x768) IPS	10-point Multi-touch	256GB SSD Opal2	Intel 8260 ac, 2x2 + BT4.1	None	None	None	None	None	Silver Carbon	720p	Backlit	Pen Pro	None	None	4-cell (44Wh)	45W	Win10 Pro 64	1-year, Depot	08/16



ThinkPad Yoga 460 Platform Specifications

Product Specifications Reference (PSREF)

Processor	6th Generation Intel® Core™ i5 / i7 Processor									Smart card reader	None
	Processor Number	# of Cores	# of Threads	Base Frequency	Max Turbo Frequency	Cache	Memory Types	Processor Graphics	vPro	Media reader	4-in-1 reader (MMC, SD, SDHC, SDXC)
	i5-6200U	2	4	2.3 GHz	2.8 GHz	3MB	DDR3L-1600	Intel HD Graphics 520	No	Ports	Three USB 3.0 (one Always On), Mini DisplayPort, HDMI, Onelink+ connector, combo audio / microphone jack
	i5-6300U			2.4 GHz	3.0 GHz	3MB				Adapter (optional)	HDMI-VGA: Lenovo HDMI to VGA Monitor Cable
	i7-6500U			2.5 GHz	3.1 GHz	4MB				mDP-VGA: Lenovo Mini DisplayPort to VGA Monitor Cable	
i7-6600U	2.6 GHz			3.4 GHz	4MB	RJ45: ThinkPad OneLink+ to RJ45 adapter					
										VGA/RJ45: ThinkPad OneLink+ to VGA/RJ45 adapter	
Graphics	Intel HD Graphics 520 in processor, supports external digital monitor via HDMI or Mini DisplayPort; supports dual independent displays; Max resolution: 3840x2160 (Mini DisplayPort) @60Hz; 1920x1080 (HDMI) @60Hz									Camera	HD720p resolution, fixed focus
Chipset	Intel SoC (System on Chip) platform									Audio support	HD Audio, Conexant® CX11852 codec, Dolby® DAX2 / stereo speakers, 1.5W x 2 / dual array microphone, combo audio / microphone jack
Memory	16GB max / 1600MHz DDR3L / one 204-pin SO-DIMM sockets									Keyboard	6-row, spill-resistant, multimedia Fn keys, LED backlit
Display	<i>Some:</i> 14.0" (355mm) WQHD (2560x1440), glare, LED backlight, IPS, 300 nits, 16:9 aspect ratio, 700:1 contrast ratio (only available in US) <i>Some:</i> 14.0" (355mm) FHD (1920x1080), anti-glare, LED backlight, IPS, 250 nits, 16:9 aspect ratio, 700:1 contrast ratio <i>Some:</i> 14.0" (355mm) FHD (1920x1080), glare, LED backlight, IPS, 250 nits, 16:9 aspect ratio, 700:1 contrast ratio									UltraNav™	TrackPoint® pointing device and buttonless Mylar surface touchpad, multi-touch
Multi-touch	Capacitive touch panel, supports 10-finger gesture									Security	Power-on password, hard disk password, supervisor password, security keyhole
Hinge	Yoga hinge, 360 degree									Security chip	<i>Some:</i> Firmware TPM 2.0, integrated in chipset <i>Some:</i> Discrete TPM 1.2, TCG Certified <i>Some:</i> Discrete TPM 1.2 TCG Certified and Firmware TPM 2.0 integrated in chipset
Convert-mode	Laptop, tent, stand, and tablet									vPro (optional)	Intel vPro Technology
Pen (optional)	ThinkPad Pen Pro, active pen for multi-touch display									Fingerprint reader	Swipe fingerprint reader under C cover
Storage	<i>Some:</i> SSD / SATA 6.0Gb/s <i>Some:</i> HDD / SATA 6.0Gb/s, 2.5" wide, removable, upgradable, Active Protection System™ <i>Some:</i> SSHD with 8GB NAND flash memory									NFC	None
Optical	None									Battery type	Li-Polymer 3-cell (53Wh)
M.2 SSD(opt)	16GB									Battery life	Up to 8.0 hr
Ethernet	Gigabit Ethernet via optional Ethernet (RJ-45) adapter (by native Intel Ethernet Connection I219-V (Non-vPro) or I219-LM (vPro))									AC adapter	45W or 65W AC adapter
WLAN	11ac+BT, Intel Dual Band Wireless-AC 8260, 2x2, M.2 Card									Light sensor	Ambient Light Sensor
Bluetooth™	Bluetooth wireless, integrated in Wi-Fi + Bluetooth combo adapter									G-sensor	3D accelerometer and 3D magnetometer
WWAN (optional)	<i>One of the following, configurable by model:</i> <ul style="list-style-type: none"> Wireless WAN, Sierra Wireless EM7455, Qualcomm® 4G LTE-Advanced/DC-HSPA+/HSPA+/HSPA/UMTS/GNSS, M.2 card Wireless WAN, HUAWEI ME906S, HUAWEI 4G LTE/WCDMA/HSPA/GSM/GPRS/EDGE/GNSS, M.2 card 									Compass	3D compass
SIM card	Micro-SIM card slot									Gyroscope	3D gyrometer
Dimensions	WxDxH: 13.30" x 9.29" x 0.74"; 338.0mm x 236.0mm x 19.0mm									Preload	<i>Some:</i> Windows 10 Pro 64 <i>Some:</i> Windows 10 Home 64 <ul style="list-style-type: none"> Lenovo Solution Center Lenovo SHAREit Lenovo Companion Lenovo Settings Microsoft Office preloaded; purchase a product key to activate McAfee® Live Safe (30-day trial)
Weight	From 3.90 lb (1.80kg)									Limited warranty	<i>One of the following, configurable by model:</i> <ul style="list-style-type: none"> 1-year depot repair service 3-year/1-yr battery depot repair service 3-year/1-yr battery limited onsite service
Case color	Black or Silver									Mil-Spec test	MIL-STD-810G military certification
Case material	<i>Carbon:</i> Carbon-Fiber Hybrid display cover <i>Aluminum:</i> Aluminum display cover									Environment	EPEAT™ Silver; ENERGY STAR®; RoHS-compliant

Model	Region	Processor	vPro	Graphics	Memory	Display	Multi-touch	Case Material	Storage	M.2 SSD	Optical	WLAN + Bluetooth	WWAN	SIM Card	Monitor Cable	Adapter	Color	Camera	Keyboard	Pen	Finger-print Reader	TPM	Battery	Power Adapter	Operating System	Warranty	Global	Ann Date (m/y)
20EM001JUS	US	i7-6600U	vPro	Intel HD 520	8GBx1	14" WQHD (2560x1440) IPS Glossy	10-point Multi-touch	Carbon	256GB SSD Opal2	None	None	Intel 8260 ac, 2x2 + BT4.1	None	None	None	None	Black	720p	Backlit	Pen Pro	Finger-print Reader	dTPM1.2 + FW TPM2.0	3-cell (53Wh)	45W	Windows 10 Pro 64	1-year, Depot	No	02/16
20EM001LUS	US	i5-6200U	No	Intel HD 520	8GBx1	14" FHD (1920x1080) IPS AG	10-point Multi-touch	Carbon	180GB SSD Opal2	None	None	Intel 8260 ac, 2x2 + BT4.1	None	None	None	None	Black	720p	Backlit	Pen Pro	Finger-print Reader	dTPM1.2 + FW TPM2.0	3-cell (53Wh)	45W	Windows 10 Pro 64	1-year, Depot	No	03/16
20EM001MUS	US	i7-6500U	No	Intel HD 520	8GBx1	14" FHD (1920x1080) IPS AG	10-point Multi-touch	Carbon	256GB SSD Opal2	None	None	Intel 8260 ac, 2x2 + BT4.1	None	None	None	None	Black	720p	Backlit	Pen Pro	Finger-print Reader	dTPM1.2 + FW TPM2.0	3-cell (53Wh)	45W	Windows 10 Pro 64	1-year, Depot	No	02/16
20EM001NUS	US	i5-6200U	No	Intel HD 520	8GBx1	14" FHD (1920x1080) IPS AG	10-point Multi-touch	Carbon	192GB SSD	None	None	Intel 8260 ac, 2x2 + BT4.1	None	None	None	None	Black	720p	Backlit	Pen Pro	Finger-print Reader	dTPM1.2 + FW TPM2.0	3-cell (53Wh)	45W	Windows 10 Pro 64	1-year, Depot	No	03/16
20EM001PUS	US	i5-6200U	No	Intel HD 520	4GBx1	14" FHD (1920x1080) IPS AG	10-point Multi-touch	Carbon	192GB SSD	None	None	Intel 8260 ac, 2x2 + BT4.1	None	None	None	None	Black	720p	Backlit	Pen Pro	Finger-print Reader	dTPM1.2 + FW TPM2.0	3-cell (53Wh)	45W	Windows 10 Pro 64	1-year, Depot	No	02/16
20EM001QUS	US	i5-6200U	No	Intel HD 520	4GBx1	14" FHD (1920x1080) IPS AG	10-point Multi-touch	Carbon	128GB SSD	None	None	Intel 8260 ac, 2x2 + BT4.1	None	None	None	None	Black	720p	Backlit	Pen Pro	Finger-print Reader	dTPM1.2 + FW TPM2.0	3-cell (53Wh)	45W	Windows 10 Pro 64	1-year, Depot	No	03/16
20EM001RUS	US	i5-6300U	vPro	Intel HD 520	8GBx1	14" FHD (1920x1080) IPS AG	10-point Multi-touch	Carbon	256GB SSD Opal2	None	None	Intel 8260 ac, 2x2 + BT4.1	None	None	None	None	Black	720p	Backlit	Pen Pro	Finger-print Reader	dTPM1.2 + FW TPM2.0	3-cell (53Wh)	45W	Windows 10 Pro 64	1-year, Depot	No	03/16
20EM001SUS	US	i5-6300U	vPro	Intel HD 520	8GBx1	14" FHD (1920x1080) IPS AG	10-point Multi-touch	Carbon	192GB SSD	None	None	Intel 8260 ac, 2x2 + BT4.1	None	None	None	None	Black	720p	Backlit	Pen Pro	Finger-print Reader	dTPM1.2 + FW TPM2.0	3-cell (53Wh)	45W	Windows 10 Pro 64	1-year, Depot	No	02/16
20EM001TUS	US	i5-6300U	vPro	Intel HD 520	8GBx1	14" FHD (1920x1080) IPS AG	10-point Multi-touch	Carbon	180GB SSD Opal2	None	None	Intel 8260 ac, 2x2 + BT4.1	None	None	None	None	Black	720p	Backlit	Pen Pro	Finger-print Reader	dTPM1.2 + FW TPM2.0	3-cell (53Wh)	45W	Windows 10 Pro 64	1-year, Depot	No	03/16
20EM001UUS	US	i5-6200U	No	Intel HD 520	8GBx1	14" FHD (1920x1080) IPS AG	10-point Multi-touch	Carbon	256GB SSD Opal2	None	None	Intel 8260 ac, 2x2 + BT4.1	None	None	None	None	Black	720p	Backlit	Pen Pro	Finger-print Reader	dTPM1.2 + FW TPM2.0	3-cell (53Wh)	45W	Windows 10 Pro 64	1-year, Depot	No	03/16
20EM001XUS	US	i5-6300U	vPro	Intel HD 520	8GBx1	14" FHD (1920x1080) IPS Glossy	10-point Multi-touch	Aluminum	192GB SSD	None	None	Intel 8260 ac, 2x2 + BT4.1	None	None	None	None	Silver	720p	Backlit	Pen Pro	None	dTPM1.2 + FW TPM2.0	3-cell (53Wh)	45W	Windows 10 Pro 64	1-year, Depot	No	03/16
20EM0023US	US	i7-6600U	vPro	Intel HD 520	8GBx1	14" WQHD (2560x1440) IPS Glossy	10-point Multi-touch	Aluminum	256GB SSD Opal2	None	None	Intel 8260 ac, 2x2 + BT4.1	None	None	None	None	Silver	720p	Backlit	Pen Pro	None	dTPM1.2 + FW TPM2.0	3-cell (53Wh)	45W	Windows 10 Pro 64	1-year, Depot	No	03/16
20EM0024US	US	i7-6600U	vPro	Intel HD 520	8GBx1	14" FHD (1920x1080) IPS Glossy	10-point Multi-touch	Aluminum	256GB SSD Opal2	None	None	Intel 8260 ac, 2x2 + BT4.1	None	None	None	None	Silver	720p	Backlit	Pen Pro	None	dTPM1.2 + FW TPM2.0	3-cell (53Wh)	45W	Windows 10 Pro 64	1-year, Depot	No	03/16
20EM0025US	US	i5-6200U	No	Intel HD 520	4GBx1	14" FHD (1920x1080) IPS Glossy	10-point Multi-touch	Aluminum	192GB SSD	None	None	Intel 8260 ac, 2x2 + BT4.1	None	None	None	None	Silver	720p	Backlit	Pen Pro	None	dTPM1.2 + FW TPM2.0	3-cell (53Wh)	45W	Windows 10 Pro 64	1-year, Depot	No	03/16
20EM0026US	US	i5-6200U	No	Intel HD 520	4GBx1	14" FHD (1920x1080) IPS Glossy	10-point Multi-touch	Aluminum	128GB SSD	None	None	Intel 8260 ac, 2x2 + BT4.1	None	None	None	None	Silver	720p	Backlit	Pen Pro	None	dTPM1.2 + FW TPM2.0	3-cell (53Wh)	45W	Windows 10 Pro 64	1-year, Depot	No	03/16
20EM0027US	US	i5-6300U	vPro	Intel HD 520	8GBx1	14" FHD (1920x1080) IPS Glossy	10-point Multi-touch	Aluminum	256GB SSD Opal2	None	None	Intel 8260 ac, 2x2 + BT4.1	None	None	None	None	Silver	720p	Backlit	Pen Pro	None	dTPM1.2 + FW TPM2.0	3-cell (53Wh)	45W	Windows 10 Pro 64	1-year, Depot	No	03/16
20EM0028US	US	i7-6500U	No	Intel HD 520	8GBx1	14" FHD (1920x1080) IPS Glossy	10-point Multi-touch	Aluminum	256GB SSD Opal2	None	None	Intel 8260 ac, 2x2 + BT4.1	None	None	None	None	Silver	720p	Backlit	Pen Pro	None	dTPM1.2 + FW TPM2.0	3-cell (53Wh)	45W	Windows 10 Pro 64	1-year, Depot	No	03/16
20EM0029US	US	i5-6200U	No	Intel HD 520	8GBx1	14" FHD (1920x1080) IPS Glossy	10-point Multi-touch	Aluminum	192GB SSD	None	None	Intel 8260 ac, 2x2 + BT4.1	None	None	None	None	Silver	720p	Backlit	Pen Pro	None	dTPM1.2 + FW TPM2.0	3-cell (53Wh)	45W	Windows 10 Pro 64	1-year, Depot	No	03/16
20EM002AUS	US	i5-6200U	No	Intel HD 520	8GBx1	14" FHD (1920x1080) IPS Glossy	10-point Multi-touch	Aluminum	180GB SSD Opal2	None	None	Intel 8260 ac, 2x2 + BT4.1	None	None	None	None	Silver	720p	Backlit	Pen Pro	None	dTPM1.2 + FW TPM2.0	3-cell (53Wh)	45W	Windows 10 Pro 64	1-year, Depot	No	03/16
20EM002BUS	US	i5-6200U	No	Intel HD 520	8GBx1	14" FHD (1920x1080) IPS Glossy	10-point Multi-touch	Aluminum	256GB SSD Opal2	None	None	Intel 8260 ac, 2x2 + BT4.1	None	None	None	None	Silver	720p	Backlit	Pen Pro	None	dTPM1.2 + FW TPM2.0	3-cell (53Wh)	45W	Windows 10 Pro 64	1-year, Depot	No	03/16

Model	Region	Processor	vPro	Graphics	Memory	Display	Multi-touch	Case Material	Storage	M.2 SSD	Optical	WLAN + Bluetooth	WWAN	SIM Card	Monitor Cable	Adapter	Color	Camera	Keyboard	Pen	Finger-print Reader	TPM	Battery	Power Adapter	Operating System	Warranty	Global	Ann Date (m/y)
20EM002CUS	US	i5-6300U	vPro	Intel HD 520	8GBx1	14" FHD (1920x1080) IPS Glossy	10-point Multi-touch	Aluminum	180GB SSD Opal2	None	None	Intel 8260 ac, 2x2 + BT4.1	None	None	None	None	Silver	720p	Backlit	Pen Pro	None	dTPM1.2 + FW TPM2.0	3-cell (53Wh)	45W	Windows 10 Pro 64	1-year, Depot	No	03/16
20EM002FUS	US	i7-6600U	vPro	Intel HD 520	8GBx1	14" FHD (1920x1080) IPS AG	10-point Multi-touch	Carbon	256GB SSD Opal2	None	None	Intel 8260 ac, 2x2 + BT4.1	Sierra EM7455	None	None	None	Black	720p	Backlit	Pen Pro	Finger-print Reader	dTPM1.2 + FW TPM2.0	3-cell (53Wh)	45W	Windows 10 Pro 64	1-year, Depot	No	04/16
20EM002GUS	US	i5-6300U	vPro	Intel HD 520	8GBx1	14" FHD (1920x1080) IPS AG	10-point Multi-touch	Carbon	256GB SSD Opal2	None	None	Intel 8260 ac, 2x2 + BT4.1	Sierra EM7455	None	None	None	Black	720p	Backlit	Pen Pro	Finger-print Reader	dTPM1.2 + FW TPM2.0	3-cell (53Wh)	45W	Windows 10 Pro 64	1-year, Depot	No	04/16

Availability: All offers subject to availability. Lenovo reserves the right to alter product offerings and specifications at any time, without notice. Lenovo is not responsible for photographic or typographic errors.

Warranty: For a copy of applicable product warranties, go to http://support.lenovo.com/en_US/product-service/warranty-status/WarrantyPolicies.page. Lenovo makes no representation or warranty regarding third party products or services.

Footnotes:

- ¹ Power management, including Intel® SpeedStep® Technology, reduces processor speed when in battery mode.
- ² **Weight** includes battery and standard optical drive; weight may vary due to vendor components, manufacturing process and options.
- ³ **Thinness** may vary at certain points on the system.
- ⁴ **Wireless capability:** Requires compatible wireless-enabled options sold separately.
- ⁵ **TAA:** ThinkPad notebook is compliant with the U.S. Federal Government's country-of-origin requirements prescribed in 48 C.F.R. Subpart 25.4; Trade Act Agreement (TAA) model.
- ⁶ **Public network download modem speeds** are limited to 53Kbps. Upload speeds are limited to 48Kbps for V.92 modems. Actual speeds depend on many factors and are often less than the maximum possible. V.92 functions and speeds require compatible phone line and server equipment. Check with your telephone and ISP service providers for availability.
- ⁷ **Maximum memory capacity** may require the replacement of standard component with largest supported component available. On ThinkPad systems, even though it is possible to physically install 4GB of memory, the actual amount of memory addressable by a 32-bit operating system will be limited to 3GB. This limitation does not exist with 64-bit operating systems.
- ⁸ **Hard drive:** GB = billion bytes, TB = trillion bytes. Accessible capacity is less; up to 4GB is service partition.
- ⁹ **CD/DVD drive speeds** list maximum rates; rates are variable and are often less than the maximum.
- ¹⁰ **Battery:** These model numbers achieved the battery life based on MobileMark® 2012 during testing. Battery life (and recharge times) will vary based on many factors including screen brightness, applications, features, power management, battery conditioning, and other customer preferences.
- ¹¹ **External monitor:** This system supports a maximum of two external monitors. The integrated display(s) must be disabled to support two external monitors.
- ¹² **Limited warranty:** Support unrelated to a warranty issue may be subject to additional charges.
- ¹³ **Internet access not included.**
- ¹⁴ **Included software** may differ from its retail version (if available), and may not include user manuals or all program functionality. Software license agreements may apply.
- ¹⁶ **Activating Verizon Wireless Service:** Lenovo customers will be contacted after purchase to activate service; requires separate agreement with Verizon Wireless and is subject to the Customer Agreement, Calling Plan, and credit approval. Service, airtime, and early termination charges may apply. Verizon Wireless, not Lenovo, is solely responsible for service. Service not available in all areas; purchaser is responsible for verifying that service is available for the intended location before purchasing a computer equipped with WAN card. Network details, coverage limitations, and maps at www.verizonwireless.com.
- ¹⁷ **International Warranty Service** is available in any country in which this product is sold and serviced. Service delivery methods and parts availability vary by country, may be different from that in the country of purchase, and are subject to change without notice. Fees and restrictions may apply in some countries.
- ¹⁸ **Telephone support** may be subject to additional charges, even during the limited warranty period. Response times may vary. May exclude some holidays. If a machine is listed as having "On-site service for select repairs", this means that onsite service is available only for the replacement of select parts. For all other warranty repairs, Lenovo will provide the customer a replacement part for customer installation. The parts for which onsite service is available varies by machine, but may include the processor, power supply, heat sink, system board, or base cover. For ThinkPad notebooks with Depot or Courier service, Lenovo will attempt to diagnose and resolve the problem remotely before sending a courier.
- ¹⁹ **Depot repair service:** The customer may be asked certain diagnostic questions before a courier is sent. Your ThinkPad purchase includes this depot repair service, available in the U.S. during the limited warranty period.
- ²⁰ **Operating System:** Level of support varies by operating system. Operating systems not preloaded on the system may not provide full feature functionality. Refer to lenovo.com/pc/support and enter your machine type and model number for more information.
- ²¹ **For combination drives,** maximum possible speeds only are given in the following order: CD write, CD rewrite, CD read, DVD read.

²² **Lenovo Services:** These services are available for machines normally used for business, professional, or trade purposes, rather than personal, family, or household purposes. Not all machine types and models are covered. Service period begins with the equipment date of purchase. Service must be purchased during the original limited product warranty period. Service levels are response time objectives and are not guarantees. If the machine problem turns out to be a Customer Replaceable Unit (CRU), a part will be express shipped to you for quick replacement. Onsite 24x7x2-hour service is not available in all locations. For ThinkPad notebooks requiring LCD or other component replacement, Lenovo may choose to perform service at the depot repair center. Calls must be received by 5 pm local time in order to qualify for Next Business Day service. P&L means parts and labor. P/U means pick-up. See Lenovo Warranty Services terms and conditions for complete details and restrictions.

²³ **Activating AT&T Wireless Service:** Requires separate agreement with AT&T, subject to service agreement, rate plan and coverage maps. AT&T, not Lenovo, is solely responsible for service. Coverage not available in all areas; AT&T BroadbandConnect available in select metropolitan markets. Special credit and tenure restrictions and additional charges may apply to international roaming. A network connection, third-party software, additional hardware, and/or subscription to a third-party service may be required for certain solutions/applications. Additional restrictions apply, including early termination fee; see www.wireless.att.com for details. To activate call Lenovo Wireless Activation Hot Line at 1-877-299-4710.

²⁴ **Limited onsite service systems** are designed to be repaired during the applicable warranty period primarily with customer-replaceable parts provided by Lenovo. Lenovo will only send a technician onsite to perform a repair if (a) remote telephone diagnosis and/or customer part replacement are unable to resolve the problem, or (b) the part is one of the few designated by Lenovo for onsite replacement. For a list of onsite replaceable parts, contact Lenovo. Support unrelated to a warranty issue may be subject to additional charges. Lenovo onsite repair (LOR), 8 am to 5 pm, Monday through Friday coverage excluding holidays, next business day (NBD) response time.

²⁶ **Full-size keyboard:** As defined by ISO/IEC 15412.

²⁷ **Based on IEEE 802.11a and 802.11b.** A customer can not upgrade to a different wireless Mini PCI adapter due to FCC regulations. Security screws prevent removal of this adapter. This wireless LAN product has been designed to permit legal operation world-wide in regions which it is approved. This product has been tested and certified to be interoperable by the Wireless Ethernet Compatibility Alliance and is authorized to carry the Wi-Fi logo.

²⁸ **The IEEE 802.11n specification (MIMO)** has been finalized and is currently in IEEE 802.11n-2009 release. The maximum speed depends on the access point device and the number of integrated antenna used for connection. An adapter with 11a/b, 11a/b/g, 11b/g/n, or 11a/b/g/n can communicate on any of its supported formats.

³⁰ **Measures only maximum** data transfer rate, not application performance. Many factors affect application performance.

³² **Wireless:** Based on IEEE 802.11a, 802.11b, and 802.11g respectively. An adapter with 11a/b, 11b/g, or 11a/b/g can communicate on either/any of these listed formats respectively, the actual connection will be based on the access point to which it connects.

³⁶ **Wireless upgradable** allows the system to be wireless-enabled with an optional wireless Mini PCI or Mini PCI Express card. Designed to operate only with Lenovo options.

This publication was developed for products and services offered in the United States. Lenovo may not offer the products, services or features discussed in this document in other countries. Lenovo may withdraw an offering at any time. Information is subject to change without notice. Consult your local representative for information on offerings available in your area.

Lenovo reserves the right to change specifications or other product information without notice. Lenovo is not responsible for photographic or typographical errors. LENOVO PROVIDES THIS PUBLICATION "AS IS," WITHOUT WARRANTY OF ANY KIND, EITHER EXPRESS OR IMPLIED, INCLUDING THE IMPLIED WARRANTIES OF MERCHANTABILITY OR FITNESS FOR A PARTICULAR PURPOSE. Some jurisdictions do not allow disclaimer of express or implied warranties in certain transactions, therefore this disclaimer may not apply to you.



Trademarks: Lenovo, the Lenovo logo, New World, New Thinking., Access Connections, Active Protection System, Rescue and Recovery, ThinkPad, ThinkVantage, ThinkVision, ThinkPlus, ThinkCentre, TrackPoint, UltraConnect, UltraNav, and Ultrabay are trademarks or registered trademarks of Lenovo. The Bluetooth word mark and logos are owned by the Bluetooth SIG, Inc. Any use of such marks by Lenovo is under license. Microsoft, Windows, and Vista are registered trademarks of Microsoft Corporation. Intel, the Intel logo, Intel Inside logo, Intel Core and Core Inside, Intel Centrino logo, Pentium, Celeron and Intel SpeedStep are trademarks or registered trademarks of Intel Corporation or its subsidiaries in the United States and other countries. Cisco and Aironet are registered trademarks of Cisco Corporation. Linux is a trademark of Linus Torvalds in the United States, other countries, or both. Other company, product and service names may be trademarks or service marks of others.

Visit www.lenovo.com/safecomputing periodically for the latest information on safe and effective computing.

Visit www.lenovo.com/psref for the latest version of Product Specifications Reference.

© Lenovo, 2017.
All rights reserved.

Lenovo
1009 Think Place
Morrisville, NC 27560
U.S.A.

Think_Tablet&Convertible.pdf

Lenovo ThinkCentre®

PSREF



Product Specifications Reference

Version 501, January 2017

U.S.

Visit <http://psref.lenovo.com> for the latest version

Contents

Cover		
Contents		
Summary Of Change		
Chromebox		
ThinkCentre Chromebox		
ThinkCentre Chromebox Platform Specifications		
ThinkCentre Chromebox - TopSeller - 10H3		
ThinkCentre Chromebox - TopSeller - 10H5		
E Series AIO		
ThinkCentre E63z AIO		
ThinkCentre E63z AIO Platform Specifications		
ThinkCentre E63z AIO - TopSeller - 10D4		
ThinkCentre E63z AIO - TopSeller - 10D6		
ThinkCentre E63z AIO - TopSeller - 10E0		
ThinkCentre E63z AIO - TopSeller - 10E2		
ThinkCentre E63z AIO - 10D5		
ThinkCentre E63z AIO - 10D7		
ThinkCentre E63z AIO - 10E1		
ThinkCentre E63z AIO - 10E3		
M Series AIO		
ThinkCentre M700z AIO		
ThinkCentre M700z AIO Platform Specifications		
ThinkCentre M700z AIO - TopSeller - 10EY - 1 of 2		
ThinkCentre M700z AIO - TopSeller - 10EY - 2 of 2		
ThinkCentre M700z AIO - 10F1		
ThinkCentre M800z AIO		
ThinkCentre M800z AIO Platform Specifications		
ThinkCentre M800z AIO - TopSeller - 10ET - 1 of 2		
ThinkCentre M800z AIO - TopSeller - 10ET - 2 of 2		
ThinkCentre M800z AIO - TopSeller - 10EU - 1 of 2		
ThinkCentre M800z AIO - TopSeller - 10EU - 2 of 2		
ThinkCentre M800z AIO - 10EW		
ThinkCentre M900z AIO		
ThinkCentre M900z AIO Platform Specifications		
ThinkCentre M900z AIO - TopSeller - 10F2		
1	ThinkCentre M900z AIO - TopSeller - 10F3	34
2	ThinkCentre M900z AIO - 10F4	35
4	ThinkCentre M900z AIO - 10F5	36
5	M Series Desktop	37
5	ThinkCentre M600 Tiny	37
6	ThinkCentre M600 Tiny Platform Specifications	38
7	ThinkCentre M600 Tiny - TopSeller - 10G9 - 1 of 2	39
8	ThinkCentre M600 Tiny - TopSeller - 10G9 - 2 of 2	40
9	ThinkCentre M600 Tiny - TopSeller - 10GB	41
9	ThinkCentre M600 Tiny - TopSeller - 10KH - 1 of 2	42
10	ThinkCentre M600 Tiny - TopSeller - 10KH - 2 of 2	43
11	ThinkCentre M600 Tiny - 10G8	44
12	ThinkCentre M600 Tiny - 10GA	45
13	ThinkCentre M600 Tiny - 10GC	46
14	ThinkCentre M600 Tiny - 10GE	47
15	ThinkCentre M700 SFF	48
16	ThinkCentre M700 SFF Platform Specifications	49
17	ThinkCentre M700 SFF - TopSeller - 10GT - 1 of 3	50
18	ThinkCentre M700 SFF - TopSeller - 10GT - 2 of 3	51
19	ThinkCentre M700 SFF - TopSeller - 10GT - 3 of 3	52
19	ThinkCentre M700 Tiny	53
20	ThinkCentre M700 Tiny Platform Specifications	54
21	ThinkCentre M700 Tiny - TopSeller - 10HY - 1 of 4	55
22	ThinkCentre M700 Tiny - TopSeller - 10HY - 2 of 4	56
23	ThinkCentre M700 Tiny - TopSeller - 10HY - 3 of 4	57
24	ThinkCentre M700 Tiny - TopSeller - 10HY - 4 of 4	58
25	ThinkCentre M700 Tiny - TopSeller - 10JQ	59
26	ThinkCentre M700 Tower	60
27	ThinkCentre M700 Tower Platform Specifications	61
28	ThinkCentre M700 Tower - TopSeller - 10GR - 1 of 3	62
29	ThinkCentre M700 Tower - TopSeller - 10GR - 2 of 3	63
30	ThinkCentre M700 Tower - TopSeller - 10GR - 3 of 3	64
31	ThinkCentre M715 Tiny	65
32	ThinkCentre M715 Tiny Platform Specifications	66
33	ThinkCentre M715 Tiny - TopSeller - 10M3 - 1 of 2	67

Contents

ThinkCentre M715 Tiny - TopSeller - 10M3 - 2 of 2	68	ThinkCentre M900 Tower	103
ThinkCentre M79 SFF	69	ThinkCentre M900 Tower Platform Specifications	104
ThinkCentre M79 SFF Platform Specifications	70	ThinkCentre M900 Tower - TopSeller - 10FD - 1 of 2	105
ThinkCentre M79 SFF - TopSeller - 10CV	71	ThinkCentre M900 Tower - TopSeller - 10FD - 2 of 2	106
ThinkCentre M79 SFF - TopSeller - 10JB	72	ThinkCentre M900 Tower - 10FC	107
ThinkCentre M79 SFF - 10CT	73	ThinkCentre M900x Tiny	108
ThinkCentre M79 SFF - 10CW	74	ThinkCentre M900x Tiny Platform Specifications	109
ThinkCentre M79 Tower	75	ThinkCentre M900x Tiny - TopSeller - 10LX	110
ThinkCentre M79 Tower Platform Specifications	76	Tiny-In-One	111
ThinkCentre M79 Tower - TopSeller - 10CN	77	ThinkCentre Tiny-In-One 22	111
ThinkCentre M79 Tower - TopSeller - 10J7	78	ThinkCentre Tiny-In-One 22 Platform Specifications	112
ThinkCentre M79 Tower - 10CQ	79	ThinkCentre Tiny-In-One 22 - 10LK	113
ThinkCentre M79 Tower - 10CS	80	ThinkCentre Tiny-In-One 23	114
ThinkCentre M800 SFF	81	ThinkCentre Tiny-In-One 23 Platform Specifications	115
ThinkCentre M800 SFF Platform Specifications	82	ThinkCentre Tiny-In-One 23 - 10DQ	116
ThinkCentre M800 SFF - TopSeller - 10FY - 1 of 2	83	ThinkCentre Tiny-In-One 24	117
ThinkCentre M800 SFF - TopSeller - 10FY - 2 of 2	84	ThinkCentre Tiny-In-One 24 Platform Specifications	118
ThinkCentre M800 SFF - 10FX	85	ThinkCentre Tiny-In-One 24 - 10LL	119
ThinkCentre M800 Tower	86	X Series AIO	120
ThinkCentre M800 Tower Platform Specifications	87	ThinkCentre X1 AIO	120
ThinkCentre M800 Tower - TopSeller - 10FW - 1 of 2	88	ThinkCentre X1 AIO Platform Specifications	121
ThinkCentre M800 Tower - TopSeller - 10FW - 2 of 2	89	ThinkCentre X1 AIO - TopSeller - 10KE	122
ThinkCentre M800 Tower - 10FV	90	Legal Information	123
ThinkCentre M900 SFF	91		
ThinkCentre M900 SFF Platform Specifications	92		
ThinkCentre M900 SFF - TopSeller - 10FH - 1 of 2	93		
ThinkCentre M900 SFF - TopSeller - 10FH - 2 of 2	94		
ThinkCentre M900 SFF - 10FG	95		
ThinkCentre M900 Tiny	96		
ThinkCentre M900 Tiny Platform Specifications	97		
ThinkCentre M900 Tiny - TopSeller - 10FM - 1 of 3	98		
ThinkCentre M900 Tiny - TopSeller - 10FM - 2 of 3	99		
ThinkCentre M900 Tiny - TopSeller - 10FM - 3 of 3	100		
ThinkCentre M900 Tiny - TopSeller - 10NE	101		
ThinkCentre M900 Tiny - 10FL	102		

Summary of Changes

This section describes the technical changes made in this edition.

This edition might also include minor corrections and editorial changes which are not identified.

January, 2017 - Version 501

Additions in this update

▶ **New product(s)**

None

▶ **New model(s)**

ThinkCentre M715 Tiny new models announced January 2017

Withdrawals in this update

▶ **Withdrawn product(s)**

None



ThinkCentre Chromebox Platform Specifications

Product Specifications Reference (PSREF)

Processor	Intel® Celeron® or 4th Generation Intel Core™ i3 Processor						Keyboard	Some: USB Keyboard (compatible with Chrome OS), Lenovo logo	
	Processor	Cores / Threads	Frequency (Max/Base)	Cache	Memory Types	Integrated Graphics	Mouse	Some: Enhanced Optical USB Mouse, black, Lenovo logo	
	Celeron 3205U	2 / 2	1.50 GHz	2MB	DDR3L-1600	Intel HD	Mechanical	Tiny (1L), business black color; metal case, compatible with TIO 23	
	Celeron 3215U	2 / 2	1.70 GHz	2MB	DDR3L-1600	Intel HD		Chromebox only	7.0" W X 7.2" D X 1.4" H 179mm W X 182mm D X 34.5mm H 2.1 lb (0.95 kg), weight may vary by configuration
	Core i3-5005U	2 / 4	2.00 GHz	3MB	DDR3L-1600	Intel HD 5500			
* System-on-Chip (SoC) solution, integrates Intel processor core, Graphics, Memory Controller, and I/O interfaces						VESA mount	None		
Memory	<i>Celeron models:</i> 4GB max / DDR3 Low Voltage, DDR3L-1600, non-parity, one 204-pin SO-DIMM socket; <i>Core i3 models:</i> 8GB max / DDR3 Low Voltage, DDR3L-1600, non-parity, two 204-pin SO-DIMM sockets						Floor Stand	Optional system floor stand for vertical orientation	
Disk	M.2 Solid State Drive (SSD), SATA 6.0Gb/s						Power supply	65 watts AC/DC adapter, autosensing, 88% PSU (not included for TIO models)	
Optical	None						Limited warranty ³	1-year, depot service / service upgrades available <i>For Lenovo service upgrade options, please go to S-TC sheet</i>	
Onboard SATA	None						Preload	Chrome OS	
Media reader	None						Environment	ENERGY STAR® 6.0; EPEAT™ Gold rating (U.S.); GREENGUARD®; ErP Lot 3; RoHS-compliant	
Graphics	Intel HD Graphics or Intel HD Graphics 5500 , in processor, uses main memory, DirectX® 11, one DisplayPort™, one HDMI, supports dual independent display; <i>Max resolution:</i> 1920x1080 (DP) @60Hz; 1920x1080 (HDMI) @60Hz						Accessories	For compatible accessories, please go to TC-AQP sheet	
DP cable	None								
Chipset	Intel System-on-Chip (SoC) platform								
Front ports	Two USB 3.0 (supports Always On), one headphone / microphone combo jack (stereo, 3.5mm)								
Rear ports	Two USB 3.0, ethernet (RJ-45), HDMI, DisplayPort								
I/O box	None								
Audio support	High Definition (HD) Audio, Realtek ALC233 / no internal speaker								
WLAN ¹³	11ac/a/b/g/n wireless, M.2 Card, Intel Dual Band Wireless-AC 7260, Wi-Fi + BT combo 4.0 adapter, 2x2								
Bluetooth™	Bluetooth 4.0 wireless, integrated in Wi-Fi + Bluetooth combo adapter								
Ethernet	One gigabit ethernet port, Realtek RTL8111G, Wake on LAN®								
Modem	None								
Security chip	Trusted Platform Module, TCG 1.2-compliant								
Security features	Security slot (in rear for optional Kensington® MicroSaver® cable)								

See footnotes for more detailed information

© Lenovo
(G-TDS1-Spec) January 2016

ThinkCentre Chromebox - TopSeller - 10H3

Product Specifications Reference (PSREF)

Model	Region	Processor	vPro	Graphics	Memory	Storage	WLAN + Bluetooth	Keyboard / Mouse	Stand	Power Supply	Operating System	Warranty	Global	Ann Date (mm/yy)
10H30000US	US	Core i3-5005U (2C, 2.0GHz, 3MB)	No	Integrated Intel HD Graphics 5500	4GBx1	16GB SSD M.2	Intel 7260 ac, 2x2 + BT4.0	USB / USB	Floor Stand	65W Adapter 88%	Chrome OS	1-year, Depot	No	05/15
10H30002US	US	Core i3-5005U (2C, 2.0GHz, 3MB)	No	Integrated Intel HD Graphics 5500	2GBx1	16GB SSD M.2	Intel 7260 ac, 2x2 + BT4.0	USB / USB	Floor Stand	65W Adapter 88%	Chrome OS	1-year, Depot	No	05/15

ThinkCentre Chromebox - TopSeller - 10H5

Product Specifications Reference (PSREF)

Model	Region	Processor	vPro	Graphics	Memory	Storage	WLAN + Bluetooth	Keyboard / Mouse	Stand	Power Supply	Operating System	Warranty	Global	Ann Date (mm/yy)
10H50003US	US	Celeron 3205U (2C, 1.5GHz, 2MB)	No	Integrated Intel HD Graphics	4GBx1	16GB SSD M.2	Intel 7260 ac, 2x2 + BT4.0	USB / USB	Floor Stand	65W Adapter 88%	Chrome OS	1-year, Depot	No	05/15
10H50005US	US	Celeron 3205U (2C, 1.5GHz, 2MB)	No	Integrated Intel HD Graphics	2GBx1	16GB SSD M.2	Intel 7260 ac, 2x2 + BT4.0	USB / USB	Floor Stand	65W Adapter 88%	Chrome OS	1-year, Depot	No	05/15
10H5000DUS	US	Celeron 3215U (2C, 1.7GHz, 2MB)	No	Integrated Intel HD Graphics	4GBx1	16GB SSD M.2	Intel 7260 ac, 2x2 + BT4.0	USB / USB	Floor Stand	65W Adapter 88%	Chrome OS	1-year, Depot	No	05/16



ThinkCentre E63z Platform Specifications

Product Specifications Reference (PSREF)

Processor	Intel® Pentium® or 4th Generation Intel Core™ i3 Processor							Keyboard	Some: Preferred Pro USB Keyboard (USB connector), Lenovo logo Some: Lenovo Slim USB Keyboard (USB connector), Lenovo logo																	
	Processor	Cores / Threads	Clock Speed	Max Burst Frequency	Cache	Memory Types	Integrated Graphics	Mouse	Some: Ultralim Plus Wireless Keyboard (2.4GHz via USB receiver) Some: Enhanced Optical USB Mouse, Lenovo logo Some: Ultralim Plus Wireless Mouse (2.4GHz via USB receiver)																	
	Pentium J2900	4 / 4	2.41 GHz	2.66 GHz	2MB	DDR3L-1333	Intel HD																			
	Core i3-4005U	2 / 4	1.7 Ghz	-	3MB	DDR3L-1600	Intel HD 4400																			
	* System-on-Chip (SoC) solution, integrates Intel processor core, Graphics, Memory Controller, and I/O interfaces							Mechanical	<ul style="list-style-type: none"> • Business black or white • Support VESA mount (100mm) • Optional frame stand 																	
Memory	Pentium models: 8GB max ⁷ / DDR3 Low Voltage, DDR3L-1600*, non-parity, one 204-pin SO-DIMM socket								<table border="1"> <thead> <tr> <th>Dimensions (WxDxH)</th> <th>Weight (Maximum)</th> <th>Adjustments</th> </tr> </thead> <tbody> <tr> <td colspan="3">E63z non-touch with frame stand</td> </tr> <tr> <td>19.21" X 2.44" X 13.62" 488mm X 62mm X 346mm</td> <td>8.82 lb (4 kg)</td> <td>Tilt: 10° to 60° back</td> </tr> <tr> <td colspan="3">E63z touch with frame stand</td> </tr> <tr> <td>19.21" X 2.44" X 13.62" 488mm X 62mm X 346mm</td> <td>10.58 lb (4.8 kg)</td> <td>Tilt: 10° to 60° back</td> </tr> </tbody> </table>			Dimensions (WxDxH)	Weight (Maximum)	Adjustments	E63z non-touch with frame stand			19.21" X 2.44" X 13.62" 488mm X 62mm X 346mm	8.82 lb (4 kg)	Tilt: 10° to 60° back	E63z touch with frame stand			19.21" X 2.44" X 13.62" 488mm X 62mm X 346mm	10.58 lb (4.8 kg)	Tilt: 10° to 60° back
	Dimensions (WxDxH)	Weight (Maximum)	Adjustments																							
E63z non-touch with frame stand																										
19.21" X 2.44" X 13.62" 488mm X 62mm X 346mm	8.82 lb (4 kg)	Tilt: 10° to 60° back																								
E63z touch with frame stand																										
19.21" X 2.44" X 13.62" 488mm X 62mm X 346mm	10.58 lb (4.8 kg)	Tilt: 10° to 60° back																								
Core i3 models: 16GB max ⁷ / DDR3 Low Voltage, DDR3L-1600, non-parity, two 204-pin SO-DIMM sockets																										
	*System automatically clocks down for 1333MHz DDR3 memory controller																									
Disk	Some: SATA 6.0Gb/s, 2.5" Wide, 5400 rpm or 7200 rpm Some: 500GB (5400 rpm) or 1TB (5400 rpm) hybrid hard disk / with 8GB MLC NAND flash memory, SATA 6.0Gb/s, 2.5" wide Some: Solid State Drive (SSD) / SATA 6.0Gb/s, 2.5" Wide							Power supply	65 watts external adapter, autosensing, 88% PSU, 100-240V (50-60Hz)																	
Optical SATA controller	None Pentium models: Serial ATA, SATA 3.0Gb/s support, integrated in processor Core i3 models: Serial ATA, SATA 6.0Gb/s support, integrated in processor							Limited warranty ³	Some: 1-year or 3-years, limited onsite service / service upgrades available Some: 1-year or 3-years, Depot or Carry-in / service upgrades available For Lenovo service upgrade options, please go to <i>S-TC sheet</i>																	
Media reader	Optional 7-in-1 media card reader (Core i3 models only)							Preload	Windows® 7 Professional 64 preinstalled through downgrade rights in Windows 8.1 Pro 64-bit Ready to install applications (only some listed) <ul style="list-style-type: none"> • Rescue and Recovery™ • Password Manager Preloaded applications (only some listed) <ul style="list-style-type: none"> • ThinkVantage® Product Recovery • ThinkVantage System Update • ThinkVantage Communication Utility • ThinkVantage Device Experience • ThinkVantage AutoLock • Lenovo SHAREit • BlueTooth Security Lock • Desktop Power Manager • View Management Utility • Lenovo Solution Center • Lenovo Message Center Plus • Norton™ Internet Security (30 days of virus definitions) • Adobe® Reader® • Skype™ • Microsoft Office preloaded; purchase a product key to activate • Cyberlink Power2Go (DVD±RW) • Cyberlink PowerProducer (DVD±RW) • Evernote® • Nitro Pro 																	
Graphics	Intel HD Graphics or Intel HD Graphics 4400 in processor, uses main memory, Maximum resolution: 1600x900@60Hz (panel); 2560x1600@60Hz (HDMI-out)								Some: Windows 8.1 64-bit Some: Windows 8.1 Pro 64-bit Some: Windows 8.1 with Bing 64-bit Web install applications (only some listed) <ul style="list-style-type: none"> • Password Manager • Preloaded applications (only some listed) • ThinkVantage System Update • ThinkVantage AutoLock • Lenovo SHAREit • BlueTooth Security Lock • Desktop Power Manager • Lenovo Solution Center • Norton Internet Security (30 days of virus definitions) • Skype™ • Microsoft Office preloaded; purchase a product key to activate • Cyberlink PowerDVD (DVD±RW, DVD) • Cyberlink Power2Go (DVD±RW) • Cyberlink PowerProducer (DVD±RW) • Evernote® • Nitro Pro • AccuWeather • Norton™ Studio • Pokki • Hightail 																	
Display	19.5" (495.3mm) HD+ (1600x900) TFT color, LED backlight, 250 nits, 16:9 aspect ratio, 1000:1 contrast ratio, wide viewing angle (horizontal: +/- 85°; vertical: +/- 80°), frameless for touch models, anti-glare for non-touch models Optional Projected Capacitive Touch (PCT) technology, supports 10-point touch Some: 720p camera, 1.0-megapixel, fixed focus, digital microphone, LED indicator Power button on right side																									
Multi-touch																										
Camera																										
Controls																										
Chipset	Intel System-on-Chip (SoC) platform																									
Rear ports	Pentium models: Two USB 2.0, ethernet (RJ-45), DC-IN Core i3 models: Two USB 2.0, ethernet (RJ-45), HDMI-out, DC-IN																									
Side ports	Pentium models: One USB 3.0, one microphone / headphone combo jack (3.5mm) Core i3 models: One USB 3.0 (charging port), one microphone / headphone combo jack (3.5mm), 7-in-1 card reader																									
ExpressCard	None																									
PCIe Mini Card	One PCI Express Mini Card slot (half size, for WLAN)																									
Audio support	High Definition (HD) Audio, Realtek ALC233 (Pentium models) or Conexant CX20751 (Core i3 models) / internal speakers (3watt x 2)																									
WLAN ¹³	Some: 11b/g/n wireless, PCIe Half Mini Card, Realtek RTL8723BE, Wi-Fi + Bluetooth combo adapter, 1x1 Some: 11b/g/n wireless, PCIe Half Mini Card, Realtek RTL8192EE, Wi-Fi + Bluetooth combo adapter, 2x2 Some: 11b/g/n wireless, PCIe Half Mini Card, Intel Centrino® Wireless-N 7260, Wi-Fi + Bluetooth combo adapter, 2x2 Some: 11ac/a/b/g/n wireless, PCIe Half Mini Card, Intel Dual Band Wireless-AC 7260, Wi-Fi + BT combo adapter, 2x2																									
Bluetooth™	Bluetooth 4.0 wireless, integrated in Wi-Fi + Bluetooth combo adapter																									
Ethernet	One gigabit ethernet port, Realtek RTL8111G, Wake on LAN®																									
vPro & iAMT	None																									
Security chip	None							Environment	EPEAT™ Gold (For Windows models only); ENERGY STAR® 6.0 (For Windows models only); GREENGUARD®; RoHS-compliant; Cisco EnergyWise compatible; ErP Lot 3																	
Security features	<ul style="list-style-type: none"> • Security slot (in rear for attachment of optional Kensington® MicroSaver® cable; Kensington lock also locks chassis) • Power-on password • Administrator password • Hard disk password • Boot sequence control • Boot without keyboard and mouse • USB port disablement 																									

See footnotes for more detailed information

ThinkCentre E63z AIO - TopSeller - 10D4

Product Specifications Reference (PSREF)

Model	Region	Processor	Graphics	Memory	Display	Multi-touch	Storage	Optical	Media Reader	WLAN + Bluetooth	Camera	Keyboard / Mouse	Stand	Color	Operating System	Warranty	Ann Date (m/y)
10D40004US	US	Pentium J2900	Intel HD	4GBx1	19.5" HD+ (1600x900)	None	500GB 7200rpm 2.5"	None	None	RTL8723BE b/g/n, 1x1 + BT4.0	720p	USB (Slim) / USB	Frame Stand	Black	Win8.1 DG Win7 Pro 64	1-year, Onsite	08/14
10D40005US	US	Pentium J2900	Intel HD	2GBx1	19.5" HD+ (1600x900)	None	500GB 7200rpm 2.5"	None	None	RTL8723BE b/g/n, 1x1 + BT4.0	None	USB (Slim) / USB	Frame Stand	Black	Win8.1 DG Win7 Pro 64	1-year, Onsite	08/14

ThinkCentre E63z AIO - TopSeller - 10D6

Product Specifications Reference (PSREF)

Model	Region	Processor	Graphics	Memory	Display	Multi-touch	Storage	Optical	Media Reader	WLAN + Bluetooth	Camera	Keyboard / Mouse	Stand	Color	Operating System	Warranty	Ann Date (m/y)
10D60005US	US	Pentium J2900	Intel HD	4GBx1	19.5" HD+ (1600x900)	10-point Multi-touch	500GB 7200rpm 2.5"	None	None	RTL8723BE b/g/n, 1x1 + BT4.0	720p	USB (Slim) / USB	Frame Stand	Black	Win8.1 DG Win7 Pro 64	1-year, Onsite	08/14
10D60006US	US	Pentium J2900	Intel HD	4GBx1	19.5" HD+ (1600x900)	10-point Multi-touch	500GB 7200rpm 2.5"	None	None	Intel 7260 b/g/n, 2x2 + BT4.0	720p	USB (Slim) / USB	Frame Stand	Black	Win8.1 DG Win7 Pro 64	1-year, Onsite	08/14
10D60007US	US	Pentium J2900	Intel HD	2GBx1	19.5" HD+ (1600x900)	10-point Multi-touch	500GB 7200rpm 2.5"	None	None	RTL8723BE b/g/n, 1x1 + BT4.0	None	USB (Slim) / USB	Frame Stand	Black	Win8.1 DG Win7 Pro 64	1-year, Onsite	08/14

ThinkCentre E63z AIO - TopSeller - 10E0

Product Specifications Reference (PSREF)

Model	Region	Processor	Graphics	Memory	Display	Multi-touch	Storage	Optical	Media Reader	WLAN + Bluetooth	Camera	Keyboard / Mouse	Stand	Color	Operating System	Warranty	Ann Date (m/y)
10E00027US	US	i3-4005U	Intel HD 4400	4GBx1	19.5" HD+ (1600x900)	None	500GB 7200rpm 2.5"	None	7-in-1	Intel 7260 b/g/n, 2x2 + BT4.0	720p	USB / USB	Frame Stand	Black	Win8.1 DG Win7 Pro 64	1-year, Onsite	11/14
10E00028US	US	i3-4005U	Intel HD 4400	8GBx1	19.5" HD+ (1600x900)	None	500GB 7200rpm 2.5"	None	7-in-1	Intel 7260 b/g/n, 2x2 + BT4.0	720p	USB / USB	Frame Stand	Black	Win8.1 DG Win7 Pro 64	1-year, Onsite	11/14
10E00029US	US	i3-4005U	Intel HD 4400	2GBx1	19.5" HD+ (1600x900)	None	500GB 7200rpm 2.5"	None	7-in-1	Intel 7260 b/g/n, 2x2 + BT4.0	720p	USB / USB	Frame Stand	Black	Win8.1 DG Win7 Pro 64	1-year, Onsite	11/14
10E0002AUS	US	i3-4005U	Intel HD 4400	4GBx1	19.5" HD+ (1600x900)	None	64GB SSD	None	7-in-1	Intel 7260 b/g/n, 2x2 + BT4.0	720p	USB / USB	Frame Stand	Black	Win8.1 DG Win7 Pro 64	1-year, Onsite	11/14
10E0002BUS	US	i3-4005U	Intel HD 4400	4GBx1	19.5" HD+ (1600x900)	None	180GB SSD	None	7-in-1	Intel 7260 b/g/n, 2x2 + BT4.0	720p	USB / USB	Frame Stand	Black	Win8.1 DG Win7 Pro 64	1-year, Onsite	11/14

ThinkCentre E63z AIO - TopSeller - 10E2

Product Specifications Reference (PSREF)

Model	Region	Processor	Graphics	Memory	Display	Multi-touch	Storage	Optical	Media Reader	WLAN + Bluetooth	Camera	Keyboard / Mouse	Stand	Color	Operating System	Warranty	Ann Date (m/y)
10E2001QUS	US	i3-4005U	Intel HD 4400	4GBx1	19.5" HD+ (1600x900)	10-point Multi-touch	500GB 7200rpm 2.5"	None	7-in-1	Intel 7260 b/g/n, 2x2 + BT4.0	720p	USB / USB	Frame Stand	Black	Win8.1 DG Win7 Pro 64	1-year, Onsite	11/14
10E2001RUS	US	i3-4005U	Intel HD 4400	4GBx1	19.5" HD+ (1600x900)	10-point Multi-touch	180GB SSD	None	7-in-1	Intel 7260 b/g/n, 2x2 + BT4.0	720p	USB / USB	Frame Stand	Black	Win8.1 DG Win7 Pro 64	1-year, Onsite	11/14
10E2001SUS	US	i3-4005U	Intel HD 4400	8GBx1	19.5" HD+ (1600x900)	10-point Multi-touch	500GB 7200rpm 2.5"	None	7-in-1	Intel 7260 b/g/n, 2x2 + BT4.0	720p	USB / USB	Frame Stand	Black	Win8.1 DG Win7 Pro 64	1-year, Onsite	11/14
10E2001TUS	US	i3-4005U	Intel HD 4400	4GBx1	19.5" HD+ (1600x900)	10-point Multi-touch	128GB SSD	None	7-in-1	Intel 7260 b/g/n, 2x2 + BT4.0	720p	USB / USB	Frame Stand	Black	Win8.1 DG Win7 Pro 64	1-year, Onsite	11/14
10E2001UUS	US	i3-4005U	Intel HD 4400	8GBx1	19.5" HD+ (1600x900)	10-point Multi-touch	256GB SSD Opal	None	7-in-1	Intel 7260 b/g/n, 2x2 + BT4.0	720p	USB / USB	Frame Stand	Black	Win8.1 DG Win7 Pro 64	1-year, Onsite	11/14
10E20044US	US	i3-4005U	Intel HD 4400	8GBx1	19.5" HD+ (1600x900)	10-point Multi-touch	1TB 5400rpm 2.5"	None	7-in-1	Intel 7260 b/g/n, 2x2 + BT4.0	720p	USB / USB	Frame Stand	Black	Win8.1 DG Win7 Pro 64	1-year, Onsite	06/15

ThinkCentre E63z AIO - 10D5

Product Specifications Reference (PSREF)

Model	Region	Processor	Graphics	Memory	Display	Multi-touch	Storage	Optical	Media Reader	WLAN + Bluetooth	Camera	Keyboard / Mouse	Stand	Color	Operating System	Warranty	Ann Date (m/y)
10D5000FUS	US	Pentium J2900	Intel HD	4GBx1	19.5" HD+ (1600x900)	None	500GB 7200rpm 2.5"	None	None	Intel 7260 b/g/n, 2x2 + BT4.0	720p	USB / USB	Frame Stand	Black	Win8.1 DG Win7 Pro 64	3-year, Onsite	08/14

ThinkCentre E63z AIO - 10D7

Product Specifications Reference (PSREF)

Model	Region	Processor	Graphics	Memory	Display	Multi-touch	Storage	Optical	Media Reader	WLAN + Bluetooth	Camera	Keyboard / Mouse	Stand	Color	Operating System	Warranty	Ann Date (m/y)
10D7000HUS	US	Pentium J2900	Intel HD	8GBx1	19.5" HD+ (1600x900)	10-point Multi-touch	500GB 7200rpm 2.5"	None	None	Intel 7260 ac, 2x2 + BT4.0	720p	USB / USB	Frame Stand	Black	Win8.1 DG Win7 Pro 64	3-year, Onsite	08/14
10D7000KUS	US	Pentium J2900	Intel HD	4GBx1	19.5" HD+ (1600x900)	10-point Multi-touch	500GB 7200rpm 2.5"	None	None	Intel 7260 b/g/n, 2x2 + BT4.0	720p	USB / USB	Frame Stand	Black	Win8.1 DG Win7 Pro 64	3-year, Onsite	08/14

ThinkCentre E63z AIO - 10E1

Product Specifications Reference (PSREF)

Model	Region	Processor	Graphics	Memory	Display	Multi-touch	Storage	Optical	Media Reader	WLAN + Bluetooth	Camera	Keyboard / Mouse	Stand	Color	Operating System	Warranty	Ann Date (m/y)
10E10002US	US	i3-4005U	Intel HD 4400	4GBx1	19.5" HD+ (1600x900)	None	500GB 7200rpm 2.5"	None	7-in-1	Intel 7260 b/g/n, 2x2 + BT4.0	720p	USB / USB	Frame Stand	Black	Win8.1 DG Win7 Pro 64	3-year, Onsite	11/14
10E10005US	US	i3-4005U	Intel HD 4400	4GBx1	19.5" HD+ (1600x900)	None	180GB SSD	None	7-in-1	Intel 7260 b/g/n, 2x2 + BT4.0	720p	USB / USB	Frame Stand	Black	Win8.1 DG Win7 Pro 64	3-year, Onsite	11/14
10E10006US	US	i3-4005U	Intel HD 4400	8GBx1	19.5" HD+ (1600x900)	None	256GB SSD Opal	None	7-in-1	Intel 7260 b/g/n, 2x2 + BT4.0	720p	USB / USB	Frame Stand	Black	Win8.1 DG Win7 Pro 64	3-year, Onsite	11/14
10E10007US	US	i3-4005U	Intel HD 4400	4GBx1	19.5" HD+ (1600x900)	None	64GB SSD	None	7-in-1	Intel 7260 b/g/n, 2x2 + BT4.0	720p	USB / USB	Frame Stand	Black	Win8.1 DG Win7 Pro 64	3-year, Onsite	11/14
10E10008US	US	i3-4005U	Intel HD 4400	8GBx1	19.5" HD+ (1600x900)	None	500GB 7200rpm 2.5"	None	7-in-1	Intel 7260 b/g/n, 2x2 + BT4.0	720p	USB / USB	Frame Stand	Black	Win8.1 DG Win7 Pro 64	3-year, Onsite	11/14

ThinkCentre E63z AIO - 10E3

Product Specifications Reference (PSREF)

Model	Region	Processor	Graphics	Memory	Display	Multi-touch	Storage	Optical	Media Reader	WLAN + Bluetooth	Camera	Keyboard / Mouse	Stand	Color	Operating System	Warranty	Ann Date (m/y)
10E30007US	US	i3-4005U	Intel HD 4400	4GBx1	19.5" HD+ (1600x900)	10-point Multi-touch	500GB 7200rpm 2.5"	None	7-in-1	Intel 7260 b/g/n, 2x2 + BT4.0	720p	USB / USB	Frame Stand	Black	Win8.1 DG Win7 Pro 64	3-year, Onsite	11/14
10E30008US	US	i3-4005U	Intel HD 4400	4GBx1	19.5" HD+ (1600x900)	10-point Multi-touch	180GB SSD	None	7-in-1	Intel 7260 b/g/n, 2x2 + BT4.0	720p	USB / USB	Frame Stand	Black	Win8.1 DG Win7 Pro 64	3-year, Onsite	11/14
10E30009US	US	i3-4005U	Intel HD 4400	8GBx1	19.5" HD+ (1600x900)	10-point Multi-touch	500GB 7200rpm 2.5"	None	7-in-1	Intel 7260 b/g/n, 2x2 + BT4.0	720p	USB / USB	Frame Stand	Black	Win8.1 DG Win7 Pro 64	3-year, Onsite	11/14
10E3000AUS	US	i3-4005U	Intel HD 4400	8GBx1	19.5" HD+ (1600x900)	10-point Multi-touch	256GB SSD Opal	None	7-in-1	Intel 7260 b/g/n, 2x2 + BT4.0	720p	USB / USB	Frame Stand	Black	Win8.1 DG Win7 Pro 64	3-year, Onsite	11/14



ThinkCentre M700z Platform Specifications

Product Specifications Reference (PSREF)

Processor	Intel® Celeron®, Intel Pentium®, or 6th Generation Intel Core™ i3 / i5 / i7 Processor	Keyboard	<i>Some:</i> Preferred Pro USB Keyboard (USB connector), Lenovo logo <i>Some:</i> Lenovo Slim USB Keyboard (USB connector), black <i>Some:</i> Ultralim Plus Wireless Keyboard (2.4GHz via USB receiver), black <i>Some:</i> Enhanced Optical USB Mouse, black, Lenovo logo <i>Some:</i> Ultralim Plus Wireless Mouse (2.4GHz via USB receiver), black																																																	
	<table border="1"> <thead> <tr> <th>Processor</th> <th>Cores / Threads</th> <th>Frequency Base/Max(GHz)</th> <th>Cache</th> <th>Memory Types</th> <th>Integrated Graphics</th> </tr> </thead> <tbody> <tr> <td>Celeron G3900T</td> <td>2 / 2</td> <td>2.6 G</td> <td>2 MB</td> <td>DDR4-2133</td> <td>HD 510</td> </tr> <tr> <td>Pentium G4400T</td> <td>2 / 2</td> <td>2.9 G</td> <td>3 MB</td> <td>DDR4-2133</td> <td>HD 510</td> </tr> <tr> <td>Core i3-6100T</td> <td>2 / 4</td> <td>3.2 G</td> <td>3 MB</td> <td>DDR4-2133</td> <td>HD 530</td> </tr> <tr> <td>Core i5-6400T</td> <td>4 / 4</td> <td>2.2 G / 2.8 G</td> <td>6 MB</td> <td>DDR4-2133</td> <td>HD 530</td> </tr> <tr> <td>Core i5-6500T</td> <td>4 / 4</td> <td>2.5 G / 3.1 G</td> <td>6 MB</td> <td>DDR4-2133</td> <td>HD 530</td> </tr> <tr> <td>Core i5-6600T</td> <td>4 / 4</td> <td>2.7 G / 3.5 G</td> <td>6 MB</td> <td>DDR4-2133</td> <td>HD 530</td> </tr> <tr> <td>Core i7-6700T</td> <td>4 / 8</td> <td>2.8 G / 3.6 G</td> <td>8 MB</td> <td>DDR4-2133</td> <td>HD 530</td> </tr> </tbody> </table>	Processor	Cores / Threads	Frequency Base/Max(GHz)	Cache	Memory Types	Integrated Graphics	Celeron G3900T	2 / 2	2.6 G	2 MB	DDR4-2133	HD 510	Pentium G4400T	2 / 2	2.9 G	3 MB	DDR4-2133	HD 510	Core i3-6100T	2 / 4	3.2 G	3 MB	DDR4-2133	HD 530	Core i5-6400T	4 / 4	2.2 G / 2.8 G	6 MB	DDR4-2133	HD 530	Core i5-6500T	4 / 4	2.5 G / 3.1 G	6 MB	DDR4-2133	HD 530	Core i5-6600T	4 / 4	2.7 G / 3.5 G	6 MB	DDR4-2133	HD 530	Core i7-6700T	4 / 8	2.8 G / 3.6 G	8 MB	DDR4-2133	HD 530	Mouse		
Processor	Cores / Threads	Frequency Base/Max(GHz)	Cache	Memory Types	Integrated Graphics																																															
Celeron G3900T	2 / 2	2.6 G	2 MB	DDR4-2133	HD 510																																															
Pentium G4400T	2 / 2	2.9 G	3 MB	DDR4-2133	HD 510																																															
Core i3-6100T	2 / 4	3.2 G	3 MB	DDR4-2133	HD 530																																															
Core i5-6400T	4 / 4	2.2 G / 2.8 G	6 MB	DDR4-2133	HD 530																																															
Core i5-6500T	4 / 4	2.5 G / 3.1 G	6 MB	DDR4-2133	HD 530																																															
Core i5-6600T	4 / 4	2.7 G / 3.5 G	6 MB	DDR4-2133	HD 530																																															
Core i7-6700T	4 / 8	2.8 G / 3.6 G	8 MB	DDR4-2133	HD 530																																															
		Mechanical	<ul style="list-style-type: none"> Business black color Toolless stand Support VESA mount (100mm) <table border="1"> <thead> <tr> <th></th> <th>Dimensions (WxDxH)</th> <th>Max weight (lb / kg)</th> <th>Adjustments</th> </tr> </thead> <tbody> <tr> <td>Without stand:</td> <td>19.8 X 1.5 X 13.5 (inch); 503 X 38 X 344 (mm)</td> <td>10.2 / 4.62</td> <td>N/A</td> </tr> <tr> <td>With Basic Monitor stand:</td> <td>19.8 X 9.6 X 16.2 (inch); 503 X 245 X 412 (mm)</td> <td>14.6 / 6.6</td> <td>Tilt: 45° back, -5° forward</td> </tr> <tr> <td>With Full Function Monitor stand:</td> <td>19.8 X 9.6 X 15.7 (inch); 503 X 245 X 400 (mm)</td> <td>14.9 / 6.77</td> <td>Tilt: 45° back, -5° forward; Lift: 110mm; Swivel: +/-45°</td> </tr> </tbody> </table>			Dimensions (WxDxH)	Max weight (lb / kg)	Adjustments	Without stand:	19.8 X 1.5 X 13.5 (inch); 503 X 38 X 344 (mm)	10.2 / 4.62	N/A	With Basic Monitor stand:	19.8 X 9.6 X 16.2 (inch); 503 X 245 X 412 (mm)	14.6 / 6.6	Tilt: 45° back, -5° forward	With Full Function Monitor stand:	19.8 X 9.6 X 15.7 (inch); 503 X 245 X 400 (mm)	14.9 / 6.77	Tilt: 45° back, -5° forward; Lift: 110mm; Swivel: +/-45°																																
	Dimensions (WxDxH)	Max weight (lb / kg)	Adjustments																																																	
Without stand:	19.8 X 1.5 X 13.5 (inch); 503 X 38 X 344 (mm)	10.2 / 4.62	N/A																																																	
With Basic Monitor stand:	19.8 X 9.6 X 16.2 (inch); 503 X 245 X 412 (mm)	14.6 / 6.6	Tilt: 45° back, -5° forward																																																	
With Full Function Monitor stand:	19.8 X 9.6 X 15.7 (inch); 503 X 245 X 400 (mm)	14.9 / 6.77	Tilt: 45° back, -5° forward; Lift: 110mm; Swivel: +/-45°																																																	
Memory	32GB max, DDR4 2133, two 260-pin SO-DIMM sockets, dual-channel capable	Power supply	120 watts adapter, autosensing, 89% PSU																																																	
Disk	<i>Some:</i> SATA 6.0Gb/s, 2.5" Wide, 5400 rpm or 7200 rpm <i>Some:</i> Solid State Hybrid Drive (SSHD) / with 8GB MLC NAND flash memory, SATA 6.0Gb/s, 2.5" Wide, 5400 rpm <i>Some:</i> Solid State Drive (SSD) / SATA 6.0Gb/s, 2.5" Wide	Limited warranty ³	<i>Some:</i> 1-year or 3-year, depot repair service <i>Some:</i> 1-year or 3-year, limited onsite service <i>Some:</i> 3-years, limited onsite service, OID (Onsite International Delivery) / <i>For Lenovo service upgrade options, please go to S-TC sheet</i>																																																	
Optical	<i>Some:</i> DVD, SATA 1.5Gb/s, 9.5mm high <i>Some:</i> DVD burner, SATA 1.5Gb/s, 9.5mm high	Preload	Preloaded operating system <i>Some:</i> Windows® 7 Professional 64 preinstalled through downgrade rights in Windows 10 Pro 64-bit <i>Some:</i> Windows 7 Professional 64 <i>Some:</i> Windows 10 Pro 64-bit <i>Some:</i> Windows 10 Home 64-bit																																																	
Media reader	Optional 9-in-1 media card reader		Preloaded applications (only some listed) <ul style="list-style-type: none"> Desktop Power Manager Lenovo Solution Center Lenovo REACHit Lenovo SHAREit Lenovo Bluetooth Lock (for models with Wi-Fi/BT card) McAfee® LiveSafe™ (30-day trial) Microsoft Office preloaded; purchase a product key to activate PowerDVD Create (DVD±RW) Lenovo ThinkVantage Tools - Only for Window 10 Lenovo Companion Cyberlink PowerDVD (DVD, DVD±RW) Lenovo QuickOptimizer - Only for Window 7 Rescue and Recovery Password Manager ThinkVantage System Update Lenovo Message Center Plus Adobe® Reader® 																																																	
Graphics	Intel HD Graphics 510/530 in processor, uses main memory, DirectX® 12, external monitor support via DisplayPort™;	Environment	EPEAT™ Gold rating; ENERGY STAR® 6.1; TCO Certified; ErP Lot 3; GREENGUARD® certified; RoHS-compliant																																																	
Display	20" (508mm) HD+ (1600x900) TFT color , wide viewing angle 178° (Horizontal), LED backlight, 250 nits, 16:9 aspect ratio, 1000:1 contrast ratio, anti-glare	MIL-SPEC test	MIL-STD-810G military certification (Low Pressure [Altitude], High Temperature, Low Temperature, Temperature Shock, Humidity, Sand and Dust, Vibration, Shock)																																																	
Light sensor	None	Accessories	For compatible accessories, please go to TC-AQP sheet																																																	
Multi-touch	None																																																			
Camera	Optional 1.0-megapixel camera, fixed focus, supports 720p, with digital microphone, LED indicator, physical switch on/off																																																			
Controls	Microphone mute, brightness up/down buttons, and power button																																																			
Chipset	Intel H110 Chipset																																																			
Rear ports	Four USB 2.0, ethernet (RJ-45), DisplayPort, optional serial (9-pin), Two USB 3.0 (one is Always On and fast charge), optional card reader, one headphone / microphone combo jack (3.5mm)																																																			
Side ports	One M.2 Card slot (for WLAN)																																																			
M.2 card slot	High Definition (HD) Audio, Realtek ALC233 / two internal stereo speakers (2W x 2), Dolby® Audio™ certified																																																			
Audio support	<i>Some:</i> 11ac wireless, M.2 Card, Qualcomm Atheros QCA9377 (dual band), Wi-Fi + Bluetooth 4.1 combo adapter, 1x1 <i>Some:</i> 11ac wireless, M.2 Card, Qualcomm Atheros QCA6174 (dual band), Wi-Fi + Bluetooth 4.1 combo adapter, 2x2 <i>Some:</i> 11ac wireless, M.2 Card, Intel Dual Band Wireless-AC 3165, Wi-Fi + Bluetooth 4.0 combo adapter, 1x1 <i>Some:</i> 11ac wireless, M.2 Card, Intel Dual Band Wireless-AC 8260, Wi-Fi + Bluetooth 4.1 combo adapter, 2x2																																																			
WLAN ¹³	<i>Some:</i> Bluetooth 4.0 or 4.1 wireless, integrated in Wi-Fi + Bluetooth combo adapter Gigabit ethernet, Realtek RTL8111G, Wake on LAN®																																																			
Bluetooth™	None																																																			
Ethernet	Trusted Platform Module (TPM 1.2-compliant)																																																			
Manageability	<ul style="list-style-type: none"> Security slot (in rear for attachment of optional Kensington® MicroSaver® cable; Kensington lock also locks chassis) Smart USB protection, allows keyboard/mouse only, blocks all storage devices Power-on, admin, hard disk password Boot sequence control Boot without keyboard and mouse Individual USB port disablement Optional Chassis intrusion switch 																																																			
Security chip																																																				
Security features																																																				

See footnotes for more detailed information

Model	Region	Processor	vPro	Graphics	Monitor Cable	Memory	Display	Multi-touch	Storage(HDD/SSD)	Optical	Media Reader	WLAN + Bluetooth	Optional Rear Ports	Camera	Chassis Intrusion Switch	Keyboard / Mouse	Stand	Power Supply	Operating System	Warranty	Ann Date (m/y)
10EY0006US	US	i3-6100T	No	Intel HD 530	None	8GBx1	20.0" HD+ (1600x900) WVA AG	None	256GB SSD	DVD±RW	9-in-1	3165 ac, 1x1 + BT4.0	None	720p	None	USB / USB	Monitor Stand	120W 89% Adapter	Win10 DG Win7 Pro 64	3-year, Onsite	12/15
10EY0007US	US	i3-6100T	No	Intel HD 530	None	4GBx1	20.0" HD+ (1600x900) WVA AG	None	120GB SSD	DVD±RW	9-in-1	3165 ac, 1x1 + BT4.0	None	720p	None	USB / USB	Monitor Stand	120W 89% Adapter	Win10 DG Win7 Pro 64	3-year, Onsite	12/15
10EY0008US	US	i5-6400T	No	Intel HD 530	None	4GBx1	20.0" HD+ (1600x900) WVA AG	None	120GB SSD	DVD±RW	9-in-1	3165 ac, 1x1 + BT4.0	None	720p	None	USB / USB	Monitor Stand	120W 89% Adapter	Win10 DG Win7 Pro 64	3-year, Onsite	12/15
10EY0009US	US	Celeron G3900T	No	Intel HD 510	None	4GBx1	20.0" HD+ (1600x900) WVA AG	None	500GB 7200rpm 2.5"	DVD±RW	9-in-1	3165 ac, 1x1 + BT4.0	None	720p	None	USB / USB	Monitor Stand	120W 89% Adapter	Win10 Pro 64	3-year, Onsite	12/15
10EY000AUS	US	i7-6700T	No	Intel HD 530	None	8GBx1	20.0" HD+ (1600x900) WVA AG	None	256GB SSD	DVD±RW	9-in-1	3165 ac, 1x1 + BT4.0	None	720p	None	USB / USB	Monitor Stand	120W 89% Adapter	Win10 DG Win7 Pro 64	3-year, Onsite	12/15
10EY000BUS	US	i3-6100T	No	Intel HD 530	None	8GBx1	20.0" HD+ (1600x900) WVA AG	None	500GB 7200rpm 2.5"	DVD±RW	9-in-1	3165 ac, 1x1 + BT4.0	None	720p	None	USB / USB	Monitor Stand	120W 89% Adapter	Win10 DG Win7 Pro 64	3-year, Onsite	12/15
10EY000CUS	US	i7-6700T	No	Intel HD 530	None	4GBx1	20.0" HD+ (1600x900) WVA AG	None	500GB 7200rpm 2.5"	DVD±RW	9-in-1	3165 ac, 1x1 + BT4.0	None	720p	None	USB / USB	Monitor Stand	120W 89% Adapter	Win10 Pro 64	3-year, Onsite	12/15
10EY000DUS	US	i7-6700T	No	Intel HD 530	None	4GBx1	20.0" HD+ (1600x900) WVA AG	None	120GB SSD	DVD±RW	9-in-1	3165 ac, 1x1 + BT4.0	None	720p	None	USB / USB	Monitor Stand	120W 89% Adapter	Win10 DG Win7 Pro 64	3-year, Onsite	12/15
10EY000EUS	US	i3-6100T	No	Intel HD 530	None	4GBx1	20.0" HD+ (1600x900) WVA AG	None	500GB 7200rpm 2.5"	DVD±RW	9-in-1	3165 ac, 1x1 + BT4.0	None	720p	None	USB / USB	Monitor Stand	120W 89% Adapter	Win10 DG Win7 Pro 64	3-year, Onsite	12/15
10EY000FUS	US	i5-6400T	No	Intel HD 530	None	8GBx1	20.0" HD+ (1600x900) WVA AG	None	500GB 7200rpm 2.5"	DVD±RW	9-in-1	3165 ac, 1x1 + BT4.0	None	720p	None	USB / USB	Monitor Stand	120W 89% Adapter	Win10 DG Win7 Pro 64	3-year, Onsite	12/15
10EY000GUS	US	i7-6700T	No	Intel HD 530	None	4GBx1	20.0" HD+ (1600x900) WVA AG	None	500GB 7200rpm 2.5"	DVD±RW	9-in-1	3165 ac, 1x1 + BT4.0	None	720p	None	USB / USB	Monitor Stand	120W 89% Adapter	Win10 DG Win7 Pro 64	3-year, Onsite	12/15
10EY000HUS	US	Pentium G4400T	No	Intel HD 510	None	4GBx1	20.0" HD+ (1600x900) WVA AG	None	500GB 7200rpm 2.5"	DVD±RW	9-in-1	3165 ac, 1x1 + BT4.0	None	720p	None	USB / USB	Monitor Stand	120W 89% Adapter	Win10 Pro 64	3-year, Onsite	12/15
10EY000JUS	US	i5-6400T	No	Intel HD 530	None	8GBx1	20.0" HD+ (1600x900) WVA AG	None	256GB SSD	DVD±RW	9-in-1	3165 ac, 1x1 + BT4.0	None	720p	None	USB / USB	Monitor Stand	120W 89% Adapter	Win10 DG Win7 Pro 64	3-year, Onsite	12/15
10EY000KUS	US	Celeron G3900T	No	Intel HD 510	None	4GBx1	20.0" HD+ (1600x900) WVA AG	None	500GB 7200rpm 2.5"	DVD±RW	9-in-1	3165 ac, 1x1 + BT4.0	None	720p	None	USB / USB	Monitor Stand	120W 89% Adapter	Win10 DG Win7 Pro 64	3-year, Onsite	12/15
10EY000LUS	US	i5-6400T	No	Intel HD 530	None	4GBx1	20.0" HD+ (1600x900) WVA AG	None	500GB 7200rpm 2.5"	DVD±RW	9-in-1	3165 ac, 1x1 + BT4.0	None	720p	None	USB / USB	Monitor Stand	120W 89% Adapter	Win10 DG Win7 Pro 64	3-year, Onsite	12/15
10EY000MUS	US	i3-6100T	No	Intel HD 530	None	4GBx1	20.0" HD+ (1600x900) WVA AG	None	500GB 7200rpm 2.5"	DVD±RW	9-in-1	3165 ac, 1x1 + BT4.0	None	720p	None	USB / USB	Monitor Stand	120W 89% Adapter	Win10 Pro 64	3-year, Onsite	12/15
10EY000NUS	US	i7-6700T	No	Intel HD 530	None	8GBx1	20.0" HD+ (1600x900) WVA AG	None	500GB 7200rpm 2.5"	DVD±RW	9-in-1	3165 ac, 1x1 + BT4.0	None	720p	None	USB / USB	Monitor Stand	120W 89% Adapter	Win10 DG Win7 Pro 64	3-year, Onsite	12/15
10EY000PUS	US	i5-6400T	No	Intel HD 530	None	4GBx1	20.0" HD+ (1600x900) WVA AG	None	500GB 7200rpm 2.5"	DVD±RW	9-in-1	3165 ac, 1x1 + BT4.0	None	720p	None	USB / USB	Monitor Stand	120W 89% Adapter	Win10 Pro 64	3-year, Onsite	12/15
10EY000QUS	US	Pentium G4400T	No	Intel HD 510	None	4GBx1	20.0" HD+ (1600x900) WVA AG	None	500GB 7200rpm 2.5"	DVD±RW	9-in-1	3165 ac, 1x1 + BT4.0	None	720p	None	USB / USB	Monitor Stand	120W 89% Adapter	Win10 DG Win7 Pro 64	3-year, Onsite	12/15
10EY002LUS	US	i5-6400T	No	Intel HD 530	None	8GBx1	20.0" HD+ (1600x900) WVA AG	None	256GB SSD Opal	DVD±RW	9-in-1	3165 ac, 1x1 + BT4.0	None	720p	None	USB / USB	Monitor Stand	120W 89% Adapter	Win10 DG Win7 Pro 64	3-year, Onsite	12/16

Model	Region	Processor	vPro	Graphics	Monitor Cable	Memory	Display	Multi-touch	Storage(HDD/SSD)	Optical	Media Reader	WLAN + Bluetooth	Optional Rear Ports	Camera	Chassis Intrusion Switch	Keyboard / Mouse	Stand	Power Supply	Operating System	Warranty	Ann Date (m/y)
10EY002MUS	US	i7-6700T	No	Intel HD 530	None	8GBx1	20.0" HD+ (1600x900) WVA AG	None	256GB SSD Opal	DVD±RW	9-in-1	3165 ac, 1x1 + BT4.0	None	720p	None	USB / USB	Monitor Stand	120W 89% Adapter	Win10 DG Win7 Pro 64	3-year, Onsite	12/16
10EY002NUS	US	i3-6100T	No	Intel HD 530	None	8GBx1	20.0" HD+ (1600x900) WVA AG	None	256GB SSD Opal	DVD±RW	9-in-1	3165 ac, 1x1 + BT4.0	None	720p	None	USB / USB	Monitor Stand	120W 89% Adapter	Win10 DG Win7 Pro 64	3-year, Onsite	12/16

Model	Region	Processor	vPro	Graphics	Monitor Cable	Memory	Display	Multi-touch	Storage(HDD/SSD)	Optical	Media Reader	WLAN + Bluetooth	Optional Rear Ports	Camera	Chassis Intrusion Switch	Keyboard / Mouse	Stand	Power Supply	Operating System	Warranty	Ann Date (m/y)
10F10001US	US	i5-6600T	No	Intel HD 530	None	4GBx2	20.0" HD+ (1600x900) WVA AG	None	120GB SSD	DVD±RW	9-in-1	8260 ac, 2x2, vPro + BT4.1	None	720p	Switch	2.4G / 2.4G	Monitor Stand	120W 89% Adapter	Win10 DG Win7 Pro 64	3-year, Onsite, OID	12/15
10F10002US	US	i5-6600T	No	Intel HD 530	None	4GBx2	20.0" HD+ (1600x900) WVA AG	None	128GB SSD	DVD±RW	9-in-1	8260 ac, 2x2, vPro + BT4.1	None	720p	Switch	2.4G / 2.4G	Monitor Stand	120W 89% Adapter	Win10 Pro 64	3-year, Onsite, OID	12/15
10F10003US	US	i5-6400T	No	Intel HD 530	None	4GBx1	20.0" HD+ (1600x900) WVA AG	None	1TB 5400rpm 2.5"	DVD±RW	9-in-1	8260 ac, 2x2, vPro + BT4.1	None	720p	Switch	USB / USB	Monitor Stand	120W 89% Adapter	Win10 DG Win7 Pro 64	3-year, Onsite, OID	12/15
10F10004US	US	i5-6400T	No	Intel HD 530	None	4GBx1	20.0" HD+ (1600x900) WVA AG	None	500GB 5400rpm 2.5"	DVD	None	3165 ac, 1x1 + BT4.0	None	720p	Switch	USB / USB	Basic Monitor Stand	120W 89% Adapter	Win10 DG Win7 Pro 64	3-year, Onsite, OID	12/15
10F10005US	US	i5-6400T	No	Intel HD 530	None	4GBx1	20.0" HD+ (1600x900) WVA AG	None	1TB 5400rpm 2.5"	DVD±RW	9-in-1	8260 ac, 2x2, vPro + BT4.1	None	720p	Switch	USB / USB	Monitor Stand	120W 89% Adapter	Win10 Pro 64	3-year, Onsite, OID	12/15
10F10006US	US	i5-6400T	No	Intel HD 530	None	4GBx1	20.0" HD+ (1600x900) WVA AG	None	500GB 5400rpm 2.5"	DVD	9-in-1	3165 ac, 1x1 + BT4.0	None	720p	Switch	USB / USB	Basic Monitor Stand	120W 89% Adapter	Win10 Pro 64	3-year, Onsite, OID	12/15



ThinkCentre M800z Platform Specifications

Product Specifications Reference (PSREF)

Processor	Intel® Celeron®, Intel Pentium®, or 6th Generation Intel Core™ i3 / i5 / i7 Processor	Keyboard	<i>Some:</i> Preferred Pro USB Keyboard (USB connector), Lenovo logo <i>Some:</i> Lenovo Slim USB Keyboard (USB connector), black <i>Some:</i> Ultralim Plus Wireless Keyboard (2.4GHz via USB receiver), black <i>Some:</i> Enhanced Optical USB Mouse, black, Lenovo logo <i>Some:</i> Ultralim Plus Wireless Mouse (2.4GHz via USB receiver), black																																																												
	<table border="1"> <thead> <tr> <th>Processor</th> <th>Cores / Threads</th> <th>Frequency Base/Max(GHz)</th> <th>Cache</th> <th>Memory Types</th> <th>Integrated Graphics</th> </tr> </thead> <tbody> <tr> <td>Celeron G3900</td> <td>2 / 2</td> <td>2.8 G</td> <td>2 MB</td> <td>DDR4-2133</td> <td>HD 510</td> </tr> <tr> <td>Pentium G4400</td> <td>2 / 2</td> <td>3.3 G</td> <td>3 MB</td> <td>DDR4-2133</td> <td>HD 510</td> </tr> <tr> <td>Pentium G4500</td> <td>2 / 2</td> <td>3.5 G</td> <td>3 MB</td> <td>DDR4-2133</td> <td>HD 530</td> </tr> <tr> <td>Core i3-6100</td> <td>2 / 4</td> <td>3.7 G</td> <td>3 MB</td> <td>DDR4-2133</td> <td>HD 530</td> </tr> <tr> <td>Core i3-6300</td> <td>2 / 4</td> <td>3.8 G</td> <td>4 MB</td> <td>DDR4-2133</td> <td>HD 530</td> </tr> <tr> <td>Core i5-6400</td> <td>4 / 4</td> <td>2.7 G / 3.3 G</td> <td>6 MB</td> <td>DDR4-2133</td> <td>HD 530</td> </tr> <tr> <td>Core i5-6500</td> <td>4 / 4</td> <td>3.2 G / 3.6 G</td> <td>6 MB</td> <td>DDR4-2133</td> <td>HD 530</td> </tr> <tr> <td>Core i5-6600</td> <td>4 / 4</td> <td>3.3 G / 3.9 G</td> <td>6 MB</td> <td>DDR4-2133</td> <td>HD 530</td> </tr> <tr> <td>Core i7-6700</td> <td>4 / 8</td> <td>3.4 G / 4.0 G</td> <td>8 MB</td> <td>DDR4-2133</td> <td>HD 530</td> </tr> </tbody> </table>	Processor	Cores / Threads	Frequency Base/Max(GHz)	Cache	Memory Types	Integrated Graphics	Celeron G3900	2 / 2	2.8 G	2 MB	DDR4-2133	HD 510	Pentium G4400	2 / 2	3.3 G	3 MB	DDR4-2133	HD 510	Pentium G4500	2 / 2	3.5 G	3 MB	DDR4-2133	HD 530	Core i3-6100	2 / 4	3.7 G	3 MB	DDR4-2133	HD 530	Core i3-6300	2 / 4	3.8 G	4 MB	DDR4-2133	HD 530	Core i5-6400	4 / 4	2.7 G / 3.3 G	6 MB	DDR4-2133	HD 530	Core i5-6500	4 / 4	3.2 G / 3.6 G	6 MB	DDR4-2133	HD 530	Core i5-6600	4 / 4	3.3 G / 3.9 G	6 MB	DDR4-2133	HD 530	Core i7-6700	4 / 8	3.4 G / 4.0 G	8 MB	DDR4-2133	HD 530	Mouse	
Processor	Cores / Threads	Frequency Base/Max(GHz)	Cache	Memory Types	Integrated Graphics																																																										
Celeron G3900	2 / 2	2.8 G	2 MB	DDR4-2133	HD 510																																																										
Pentium G4400	2 / 2	3.3 G	3 MB	DDR4-2133	HD 510																																																										
Pentium G4500	2 / 2	3.5 G	3 MB	DDR4-2133	HD 530																																																										
Core i3-6100	2 / 4	3.7 G	3 MB	DDR4-2133	HD 530																																																										
Core i3-6300	2 / 4	3.8 G	4 MB	DDR4-2133	HD 530																																																										
Core i5-6400	4 / 4	2.7 G / 3.3 G	6 MB	DDR4-2133	HD 530																																																										
Core i5-6500	4 / 4	3.2 G / 3.6 G	6 MB	DDR4-2133	HD 530																																																										
Core i5-6600	4 / 4	3.3 G / 3.9 G	6 MB	DDR4-2133	HD 530																																																										
Core i7-6700	4 / 8	3.4 G / 4.0 G	8 MB	DDR4-2133	HD 530																																																										
		Mechanical	<ul style="list-style-type: none"> • Business black color • Toolless stand • Support VESA mount (100mm) <table border="1"> <thead> <tr> <th></th> <th>Dimensions (WxDxH)</th> <th>Max weight (lb / kg)</th> <th>Adjustments</th> </tr> </thead> <tbody> <tr> <td>Without stand:</td> <td>21.1 X 1.8 X 14.3 (inch); 535 X 45 X 363 (mm)</td> <td>(Touch) 14.6 / 6.6 (Non-touch) 12.8 / 5.8</td> <td>N/A</td> </tr> <tr> <td>With Basic Monitor stand:</td> <td>21.1 X 9.6 X 17.0 (inch); 535 X 245 X 431 (mm)</td> <td>(Non-touch) 17.0 / 7.7</td> <td>Tilt: 45° back, -5° forward</td> </tr> <tr> <td>With UltraFlex II stand:</td> <td>21.1X 10.0 X 19.3 (inch); 535 X 253 X 489 (mm)</td> <td>(Touch) 20.3 / 9.2 (Non-touch) 18.3 / 8.3</td> <td>Tilt: 61° back, -5° forward; Lift: 160mm; Swivel: +/-45°</td> </tr> </tbody> </table>			Dimensions (WxDxH)	Max weight (lb / kg)	Adjustments	Without stand:	21.1 X 1.8 X 14.3 (inch); 535 X 45 X 363 (mm)	(Touch) 14.6 / 6.6 (Non-touch) 12.8 / 5.8	N/A	With Basic Monitor stand:	21.1 X 9.6 X 17.0 (inch); 535 X 245 X 431 (mm)	(Non-touch) 17.0 / 7.7	Tilt: 45° back, -5° forward	With UltraFlex II stand:	21.1X 10.0 X 19.3 (inch); 535 X 253 X 489 (mm)	(Touch) 20.3 / 9.2 (Non-touch) 18.3 / 8.3	Tilt: 61° back, -5° forward; Lift: 160mm; Swivel: +/-45°																																											
	Dimensions (WxDxH)	Max weight (lb / kg)	Adjustments																																																												
Without stand:	21.1 X 1.8 X 14.3 (inch); 535 X 45 X 363 (mm)	(Touch) 14.6 / 6.6 (Non-touch) 12.8 / 5.8	N/A																																																												
With Basic Monitor stand:	21.1 X 9.6 X 17.0 (inch); 535 X 245 X 431 (mm)	(Non-touch) 17.0 / 7.7	Tilt: 45° back, -5° forward																																																												
With UltraFlex II stand:	21.1X 10.0 X 19.3 (inch); 535 X 253 X 489 (mm)	(Touch) 20.3 / 9.2 (Non-touch) 18.3 / 8.3	Tilt: 61° back, -5° forward; Lift: 160mm; Swivel: +/-45°																																																												
Memory	32GB max, DDR4 2133, two 260-pin SO-DIMM sockets, dual-channel capable	Power supply	150 watts, autosensing, 85% PSU																																																												
Disk	<i>Some:</i> SATA 6.0Gb/s, 2.5" Wide, 5400 rpm or 7200 rpm <i>Some:</i> Solid State Hybrid Drive (SSHD) / with 8GB MLC NAND flash memory, SATA 6.0Gb/s, 2.5" Wide, 5400 rpm <i>Some:</i> Solid State Drive (SSD) / SATA 6.0Gb/s, 2.5" Wide	Limited warranty ³	<i>Some:</i> 1-year or 3-year, depot repair service <i>Some:</i> 1-year or 3-year, limited onsite service <i>Some:</i> 3-years, limited onsite service, OID (Onsite International Delivery) / <i>For Lenovo service upgrade options, please go to S-TC sheet</i>																																																												
Optical	<i>Some:</i> DVD, SATA 1.5Gb/s, 9.5mm high <i>Some:</i> DVD burner, SATA 1.5Gb/s, 9.5mm high	Preload	Preloaded operating system <i>Some:</i> Windows® 7 Professional 64 preinstalled through downgrade rights in Windows 10 Pro 64-bit <i>Some:</i> Windows 7 Professional 64 <i>Some:</i> Windows 10 Pro 64-bit <i>Some:</i> Windows 10 Home 64-bit																																																												
Media reader	Optional 9-in-1 media card reader		Preloaded applications (only some listed) <ul style="list-style-type: none"> • Desktop Power Manager • Lenovo Solution Center • Lenovo REACHit • Lenovo SHAREit • Lenovo Bluetooth Lock (for models with Wi-Fi/BT card) • McAfee® LiveSafe™ (30-day trial) • Microsoft Office preloaded; purchase a product key to activate • PowerDVD Create (DVD±RW) • Lenovo ThinkVantage Tools <ul style="list-style-type: none"> - Only for Window 10 • Lenovo Companion • Cyberlink PowerDVD (DVD, DVD±RW) • Lenovo QuickOptimizer - Only for Window 7 • Rescue and Recovery • Password Manager • ThinkVantage System Update • Lenovo Message Center Plus • Adobe® Reader® 																																																												
Graphics	Intel HD Graphics 510/530 in processor, uses main memory, DirectX® 12, external monitor support via DisplayPort™; <i>Max resolution:</i> 4096x2304 (DP)@60Hz																																																														
Display	21.5" (546.1mm) Full HD 1080p (1920x1080) TFT color , MVA panel, wide viewing angle (+/- 89°), LED backlight, 250 nits, 16:9 aspect ratio, 1000:1 contrast ratio, anti-glare for both touch models and non-touch models																																																														
Light sensor	None																																																														
Multi-touch	Optional Projected Capacitive Touch (PCT) technology, supports 10-point touch																																																														
Camera	Optional 1.0-megapixel camera, fixed focus, supports 720p, with digital microphone, LED indicator, physical switch on/off																																																														
Controls	Microphone mute, brightness up/down buttons, and power button																																																														
Chipset	Intel H110 Chipset																																																														
Rear ports	Four USB 2.0, ethernet (RJ-45), DisplayPort, optional serial (9-pin),																																																														
Side ports	Two USB 3.0 (one is Always On and fast charge), optional card reader, one headphone / microphone combo jack (3.5mm)																																																														
M.2 card slot	One M.2 Card slot (for WLAN)																																																														
Audio support	High Definition (HD) Audio, Realtek ALC233 / two internal stereo speakers (2W x 2), Dolby® Audio™ certified	Environment	EPEAT™ Gold rating; ENERGY STAR® 6.1; TCO Certified; ErP Lot 3; GREENGUARD® certified; RoHS-compliant																																																												
WLAN ¹³	<i>Some:</i> 11ac wireless, M.2 Card, Qualcomm Atheros QCA9377 (dual band), Wi-Fi + Bluetooth 4.1 combo adapter, 1x1 <i>Some:</i> 11ac wireless, M.2 Card, Qualcomm Atheros QCA6174 (dual band), Wi-Fi + Bluetooth 4.1 combo adapter, 2x2 <i>Some:</i> 11ac wireless, M.2 Card, Intel Dual Band Wireless-AC 3165, Wi-Fi + Bluetooth 4.0 combo adapter, 1x1 <i>Some:</i> 11ac wireless, M.2 Card, Intel Dual Band Wireless-AC 8260, Wi-Fi + Bluetooth 4.1 combo adapter, 2x2	MIL-SPEC test	MIL-STD-810G military certification (Low Pressure [Altitude], High Temperature, Low Temperature, Temperature Shock, Humidity, Sand and Dust, Vibration, Shock)																																																												
Bluetooth™	<i>Some:</i> Bluetooth 4.0 or 4.1 wireless, integrated in Wi-Fi + Bluetooth combo adapter	Accessories	For compatible accessories, please go to TC-AQP sheet																																																												
Ethernet	Gigabit ethernet, Realtek RTL8111G, Wake on LAN®																																																														
Manageability	None																																																														
Security chip	Trusted Platform Module (TPM 1.2-compliant)																																																														
Security features	<ul style="list-style-type: none"> • Security slot (in rear for attachment of optional Kensington® MicroSaver® cable; Kensington lock also locks chassis) • Smart USB protection, allows keyboard/mouse only, blocks all storage devices • Power-on, admin, hard disk password • Boot sequence control • Boot without keyboard and mouse • Individual USB port disablement • Optional Chassis intrusion switch 																																																														

See footnotes for more detailed information

Model	Region	Processor	vPro	Graphics	Monitor Cable	Memory	Display	Multi-touch	Storage(HDD/SSD)	Optical	Media Reader	WLAN + Bluetooth	Optional Rear Ports	Camera	Chassis Intrusion Switch	Keyboard / Mouse	Stand	Power Supply	Operating System	Warranty	Ann Date (m/y)
10ET0002US	US	i5-6500	No	Intel HD 530	DP to HDMI	4GBx1	21.5" FHD (1920x1080) WVA AG	10-point Multi-touch	500GB 7200rpm 2.5"	DVD±RW	9-in-1	8260 ac, 2x2 + BT4.1	None	720p	None	USB / USB	UltraFlex II Stand	150W 85% Adapter	Win10 DG Win7 Pro 64	3-year, Onsite	11/15
10ET0003US	US	i7-6700	No	Intel HD 530	None	4GBx1	21.5" FHD (1920x1080) WVA AG	10-point Multi-touch	500GB 7200rpm 2.5"	DVD±RW	9-in-1	8260 ac, 2x2 + BT4.1	None	720p	None	USB / USB	UltraFlex II Stand	150W 85% Adapter	Win10 DG Win7 Pro 64	3-year, Onsite	11/15
10ET0004US	US	i5-6500	No	Intel HD 530	None	4GBx1	21.5" FHD (1920x1080) WVA AG	10-point Multi-touch	500GB 7200rpm 2.5"	DVD±RW	9-in-1	8260 ac, 2x2 + BT4.1	None	720p	None	USB / USB	UltraFlex II Stand	150W 85% Adapter	Win10 Pro 64	3-year, Onsite	11/15
10ET0005US	US	i7-6700	No	Intel HD 530	None	8GBx1	21.5" FHD (1920x1080) WVA AG	10-point Multi-touch	500GB 7200rpm 2.5"	DVD±RW	9-in-1	8260 ac, 2x2 + BT4.1	None	720p	None	USB / USB	UltraFlex II Stand	150W 85% Adapter	Win10 DG Win7 Pro 64	3-year, Onsite	11/15
10ET0007US	US	i5-6500	No	Intel HD 530	DP to HDMI	8GBx1	21.5" FHD (1920x1080) WVA AG	10-point Multi-touch	500GB 7200rpm 2.5"	DVD±RW	9-in-1	8260 ac, 2x2 + BT4.1	None	720p	None	USB / USB	UltraFlex II Stand	150W 85% Adapter	Win10 DG Win7 Pro 64	3-year, Onsite	11/15
10ET0009US	US	i5-6400	No	Intel HD 530	None	4GBx1	21.5" FHD (1920x1080) WVA AG	10-point Multi-touch	500GB 7200rpm 2.5"	DVD±RW	9-in-1	8260 ac, 2x2 + BT4.1	None	720p	None	USB / USB	UltraFlex II Stand	150W 85% Adapter	Win10 Pro 64	3-year, Onsite	11/15
10ET000AUS	US	i5-6400	No	Intel HD 530	None	4GBx1	21.5" FHD (1920x1080) WVA AG	10-point Multi-touch	500GB 7200rpm 2.5"	DVD±RW	9-in-1	8260 ac, 2x2 + BT4.1	None	720p	None	USB / USB	UltraFlex II Stand	150W 85% Adapter	Win10 DG Win7 Pro 64	3-year, Onsite	11/15
10ET000CUS	US	i5-6400	No	Intel HD 530	None	8GBx1	21.5" FHD (1920x1080) WVA AG	10-point Multi-touch	500GB 7200rpm 2.5"	DVD±RW	9-in-1	8260 ac, 2x2 + BT4.1	None	720p	None	USB / USB	UltraFlex II Stand	150W 85% Adapter	Win10 DG Win7 Pro 64	3-year, Onsite	11/15
10ET001AUS	US	Pentium G4400	No	Intel HD 510	None	4GBx1	21.5" FHD (1920x1080) WVA AG	10-point Multi-touch	500GB 7200rpm 2.5"	DVD±RW	9-in-1	8260 ac, 2x2 + BT4.1	None	720p	None	USB / USB	UltraFlex II Stand	150W 85% Adapter	Win10 DG Win7 Pro 64	3-year, Onsite	12/15
10ET001BUS	US	i7-6700	No	Intel HD 530	None	8GBx1	21.5" FHD (1920x1080) WVA AG	10-point Multi-touch	256GB SSD	DVD±RW	9-in-1	8260 ac, 2x2 + BT4.1	None	720p	None	USB / USB	UltraFlex II Stand	150W 85% Adapter	Win10 DG Win7 Pro 64	3-year, Onsite	11/15
10ET001CUS	US	i3-6100	No	Intel HD 530	None	4GBx1	21.5" FHD (1920x1080) WVA AG	10-point Multi-touch	120GB SSD	DVD±RW	9-in-1	8260 ac, 2x2 + BT4.1	None	720p	None	USB / USB	UltraFlex II Stand	150W 85% Adapter	Win10 DG Win7 Pro 64	3-year, Onsite	12/15
10ET001DUS	US	i3-6100	No	Intel HD 530	None	8GBx1	21.5" FHD (1920x1080) WVA AG	10-point Multi-touch	500GB 7200rpm 2.5"	DVD±RW	9-in-1	8260 ac, 2x2 + BT4.1	None	720p	None	USB / USB	UltraFlex II Stand	150W 85% Adapter	Win10 DG Win7 Pro 64	3-year, Onsite	12/15
10ET001EUS	US	i5-6400	No	Intel HD 530	None	8GBx1	21.5" FHD (1920x1080) WVA AG	10-point Multi-touch	256GB SSD	DVD±RW	9-in-1	8260 ac, 2x2 + BT4.1	None	720p	None	USB / USB	UltraFlex II Stand	150W 85% Adapter	Win10 DG Win7 Pro 64	3-year, Onsite	11/15
10ET001FUS	US	i3-6100	No	Intel HD 530	None	4GBx1	21.5" FHD (1920x1080) WVA AG	10-point Multi-touch	500GB 7200rpm 2.5"	DVD±RW	9-in-1	8260 ac, 2x2 + BT4.1	None	720p	None	USB / USB	UltraFlex II Stand	150W 85% Adapter	Win10 Pro 64	3-year, Onsite	12/15
10ET001GUS	US	Celeron G3900	No	Intel HD 510	None	4GBx1	21.5" FHD (1920x1080) WVA AG	10-point Multi-touch	500GB 7200rpm 2.5"	DVD±RW	9-in-1	8260 ac, 2x2 + BT4.1	None	720p	None	USB / USB	UltraFlex II Stand	150W 85% Adapter	Win10 DG Win7 Pro 64	3-year, Onsite	12/15
10ET001HUS	US	i7-6700	No	Intel HD 530	None	4GBx1	21.5" FHD (1920x1080) WVA AG	10-point Multi-touch	500GB 7200rpm 2.5"	DVD±RW	9-in-1	8260 ac, 2x2 + BT4.1	None	720p	None	USB / USB	UltraFlex II Stand	150W 85% Adapter	Win10 Pro 64	3-year, Onsite	11/15
10ET001JUS	US	i7-6700	No	Intel HD 530	None	4GBx1	21.5" FHD (1920x1080) WVA AG	10-point Multi-touch	120GB SSD	DVD±RW	9-in-1	8260 ac, 2x2 + BT4.1	None	720p	None	USB / USB	UltraFlex II Stand	150W 85% Adapter	Win10 DG Win7 Pro 64	3-year, Onsite	11/15
10ET001KUS	US	i5-6400	No	Intel HD 530	None	4GBx1	21.5" FHD (1920x1080) WVA AG	10-point Multi-touch	120GB SSD	DVD±RW	9-in-1	8260 ac, 2x2 + BT4.1	None	720p	None	USB / USB	UltraFlex II Stand	150W 85% Adapter	Win10 DG Win7 Pro 64	3-year, Onsite	11/15
10ET001LUS	US	i3-6100	No	Intel HD 530	None	8GBx1	21.5" FHD (1920x1080) WVA AG	10-point Multi-touch	256GB SSD	DVD±RW	9-in-1	8260 ac, 2x2 + BT4.1	None	720p	None	USB / USB	UltraFlex II Stand	150W 85% Adapter	Win10 DG Win7 Pro 64	3-year, Onsite	12/15
10ET001MUS	US	i3-6100	No	Intel HD 530	None	4GBx1	21.5" FHD (1920x1080) WVA AG	10-point Multi-touch	500GB 7200rpm 2.5"	DVD±RW	9-in-1	8260 ac, 2x2 + BT4.1	None	720p	None	USB / USB	UltraFlex II Stand	150W 85% Adapter	Win10 DG Win7 Pro 64	3-year, Onsite	12/15

Model	Region	Processor	vPro	Graphics	Monitor Cable	Memory	Display	Multi-touch	Storage(HDD/SSD)	Optical	Media Reader	WLAN + Bluetooth	Optional Rear Ports	Camera	Chassis Intrusion Switch	Keyboard / Mouse	Stand	Power Supply	Operating System	Warranty	Ann Date (m/y)
10ET0026US	US	i7-6700	No	Intel HD 530	None	8GBx1	21.5" FHD (1920x1080) WVA AG	10-point Multi-touch	256GB SSD Opal	DVD±RW	9-in-1	8260 ac, 2x2 + BT4.1	None	720p	None	USB / USB	UltraFlex II Stand	150W 85% Adapter	Win10 DG Win7 Pro 64	3-year, Onsite	12/16
10ET0027US	US	i5-6400	No	Intel HD 530	None	8GBx1	21.5" FHD (1920x1080) WVA AG	10-point Multi-touch	256GB SSD Opal	DVD±RW	9-in-1	8260 ac, 2x2 + BT4.1	None	720p	None	USB / USB	UltraFlex II Stand	150W 85% Adapter	Win10 DG Win7 Pro 64	3-year, Onsite	12/16
10ET0028US	US	i3-6100	No	Intel HD 530	None	8GBx1	21.5" FHD (1920x1080) WVA AG	10-point Multi-touch	256GB SSD Opal	DVD±RW	9-in-1	8260 ac, 2x2 + BT4.1	None	720p	None	USB / USB	UltraFlex II Stand	150W 85% Adapter	Win10 DG Win7 Pro 64	3-year, Onsite	12/16

Model	Region	Processor	vPro	Graphics	Monitor Cable	Memory	Display	Multi-touch	Storage(HDD/SSD)	Optical	Media Reader	WLAN + Bluetooth	Optional Rear Ports	Camera	Chassis Intrusion Switch	Keyboard / Mouse	Stand	Power Supply	Operating System	Warranty	Ann Date (m/y)
10EU001PUS	US	i5-6400	No	Intel HD 530	None	4GBx1	21.5" FHD (1920x1080) WVA AG	None	500GB 7200rpm 2.5"	DVD±RW	9-in-1	8260 ac, 2x2 + BT4.1	None	720p	None	USB / USB	Basic Monitor Stand	150W 85% Adapter	Win10 Pro 64	3-year, Onsite	11/15
10EU001QUS	US	i7-6700	No	Intel HD 530	None	4GBx1	21.5" FHD (1920x1080) WVA AG	None	500GB 7200rpm 2.5"	DVD±RW	9-in-1	8260 ac, 2x2 + BT4.1	None	720p	None	USB / USB	UltraFlex II Stand	150W 85% Adapter	Win10 DG Win7 Pro 64	3-year, Onsite	11/15
10EU001RUS	US	i7-6700	No	Intel HD 530	None	4GBx1	21.5" FHD (1920x1080) WVA AG	None	500GB 7200rpm 2.5"	DVD±RW	9-in-1	8260 ac, 2x2 + BT4.1	None	720p	None	USB / USB	Basic Monitor Stand	150W 85% Adapter	Win10 Pro 64	3-year, Onsite	11/15
10EU001SUS	US	i5-6400	No	Intel HD 530	None	4GBx1	21.5" FHD (1920x1080) WVA AG	None	500GB 7200rpm 2.5"	DVD±RW	9-in-1	8260 ac, 2x2 + BT4.1	None	720p	None	USB / USB	UltraFlex II Stand	150W 85% Adapter	Win10 Pro 64	3-year, Onsite	11/15
10EU001TUS	US	i5-6400	No	Intel HD 530	None	4GBx1	21.5" FHD (1920x1080) WVA AG	None	500GB 7200rpm 2.5"	DVD±RW	9-in-1	8260 ac, 2x2 + BT4.1	None	720p	None	USB / USB	UltraFlex II Stand	150W 85% Adapter	Win10 DG Win7 Pro 64	3-year, Onsite	11/15
10EU001UUS	US	i7-6700	No	Intel HD 530	None	4GBx1	21.5" FHD (1920x1080) WVA AG	None	500GB 7200rpm 2.5"	DVD±RW	9-in-1	8260 ac, 2x2 + BT4.1	None	720p	None	USB / USB	UltraFlex II Stand	150W 85% Adapter	Win10 Pro 64	3-year, Onsite	11/15
10EU001VUS	US	i7-6700	No	Intel HD 530	None	8GBx1	21.5" FHD (1920x1080) WVA AG	None	500GB 7200rpm 2.5"	DVD±RW	9-in-1	8260 ac, 2x2 + BT4.1	None	720p	None	USB / USB	UltraFlex II Stand	150W 85% Adapter	Win10 DG Win7 Pro 64	3-year, Onsite	11/15
10EU001WUS	US	i5-6400	No	Intel HD 530	None	8GBx1	21.5" FHD (1920x1080) WVA AG	None	500GB 7200rpm 2.5"	DVD±RW	9-in-1	8260 ac, 2x2 + BT4.1	None	720p	None	USB / USB	UltraFlex II Stand	150W 85% Adapter	Win10 DG Win7 Pro 64	3-year, Onsite	11/15
10EU002WUS	US	i7-6700	No	Intel HD 530	None	4GBx1	21.5" FHD (1920x1080) WVA AG	None	120GB SSD	DVD±RW	9-in-1	8260 ac, 2x2 + BT4.1	None	720p	None	USB / USB	UltraFlex II Stand	150W 85% Adapter	Win10 DG Win7 Pro 64	3-year, Onsite	11/15
10EU002XUS	US	i3-6100	No	Intel HD 530	None	8GBx1	21.5" FHD (1920x1080) WVA AG	None	256GB SSD	DVD±RW	9-in-1	8260 ac, 2x2 + BT4.1	None	720p	None	USB / USB	UltraFlex II Stand	150W 85% Adapter	Win10 DG Win7 Pro 64	3-year, Onsite	12/15
10EU002YUS	US	i5-6400	No	Intel HD 530	None	8GBx1	21.5" FHD (1920x1080) WVA AG	None	256GB SSD	DVD±RW	9-in-1	8260 ac, 2x2 + BT4.1	None	720p	None	USB / USB	UltraFlex II Stand	150W 85% Adapter	Win10 DG Win7 Pro 64	3-year, Onsite	11/15
10EU0030US	US	Pentium G4400	No	Intel HD 510	None	4GBx1	21.5" FHD (1920x1080) WVA AG	None	500GB 7200rpm 2.5"	DVD±RW	9-in-1	8260 ac, 2x2 + BT4.1	None	720p	None	USB / USB	UltraFlex II Stand	150W 85% Adapter	Win10 DG Win7 Pro 64	3-year, Onsite	12/15
10EU0031US	US	i3-6100	No	Intel HD 530	None	8GBx1	21.5" FHD (1920x1080) WVA AG	None	500GB 7200rpm 2.5"	DVD±RW	9-in-1	8260 ac, 2x2 + BT4.1	None	720p	None	USB / USB	UltraFlex II Stand	150W 85% Adapter	Win10 DG Win7 Pro 64	3-year, Onsite	12/15
10EU0032US	US	Celeron G3900	No	Intel HD 510	None	4GBx1	21.5" FHD (1920x1080) WVA AG	None	500GB 7200rpm 2.5"	DVD±RW	9-in-1	8260 ac, 2x2 + BT4.1	None	720p	None	USB / USB	UltraFlex II Stand	150W 85% Adapter	Win10 DG Win7 Pro 64	3-year, Onsite	03/16
10EU0033US	US	i5-6400	No	Intel HD 530	None	4GBx1	21.5" FHD (1920x1080) WVA AG	None	120GB SSD	DVD±RW	9-in-1	8260 ac, 2x2 + BT4.1	None	720p	None	USB / USB	UltraFlex II Stand	150W 85% Adapter	Win10 DG Win7 Pro 64	3-year, Onsite	11/15
10EU0034US	US	i3-6100	No	Intel HD 530	None	4GBx1	21.5" FHD (1920x1080) WVA AG	None	500GB 7200rpm 2.5"	DVD±RW	9-in-1	8260 ac, 2x2 + BT4.1	None	720p	None	USB / USB	UltraFlex II Stand	150W 85% Adapter	Win10 DG Win7 Pro 64	3-year, Onsite	12/15
10EU0035US	US	i3-6100	No	Intel HD 530	None	4GBx1	21.5" FHD (1920x1080) WVA AG	None	120GB SSD	DVD±RW	9-in-1	8260 ac, 2x2 + BT4.1	None	720p	None	USB / USB	UltraFlex II Stand	150W 85% Adapter	Win10 DG Win7 Pro 64	3-year, Onsite	12/15
10EU0036US	US	i7-6700	No	Intel HD 530	None	8GBx1	21.5" FHD (1920x1080) WVA AG	None	256GB SSD	DVD±RW	9-in-1	8260 ac, 2x2 + BT4.1	None	720p	None	USB / USB	UltraFlex II Stand	150W 85% Adapter	Win10 DG Win7 Pro 64	3-year, Onsite	11/15
10EU0037US	US	i3-6100	No	Intel HD 530	None	4GBx1	21.5" FHD (1920x1080) WVA AG	None	500GB 7200rpm 2.5"	DVD±RW	9-in-1	8260 ac, 2x2 + BT4.1	None	720p	None	USB / USB	UltraFlex II Stand	150W 85% Adapter	Win10 Pro 64	3-year, Onsite	12/15
10EU0048US	US	i7-6700	No	Intel HD 530	None	8GBx1	21.5" FHD (1920x1080) WVA AG	None	256GB SSD Opal	DVD±RW	9-in-1	8260 ac, 2x2 + BT4.1	None	720p	None	USB / USB	UltraFlex II Stand	150W 85% Adapter	Win10 DG Win7 Pro 64	3-year, Onsite	12/16

Model	Region	Processor	vPro	Graphics	Monitor Cable	Memory	Display	Multi-touch	Storage(HDD/SSD)	Optical	Media Reader	WLAN + Bluetooth	Optional Rear Ports	Camera	Chassis Intrusion Switch	Keyboard / Mouse	Stand	Power Supply	Operating System	Warranty	Ann Date (m/y)
10EU0049US	US	i3-6100	No	Intel HD 530	None	8GBx1	21.5" FHD (1920x1080) WVA AG	None	256GB SSD Opal	DVD±RW	9-in-1	8260 ac, 2x2 + BT4.1	None	720p	None	USB / USB	UltraFlex II Stand	150W 85% Adapter	Win10 DG Win7 Pro 64	3-year, Onsite	12/16
10EU004AUS	US	i5-6400	No	Intel HD 530	None	8GBx1	21.5" FHD (1920x1080) WVA AG	None	256GB SSD Opal	DVD±RW	9-in-1	8260 ac, 2x2 + BT4.1	None	720p	None	USB / USB	UltraFlex II Stand	150W 85% Adapter	Win10 DG Win7 Pro 64	3-year, Onsite	12/16

Model	Region	Processor	vPro	Graphics	Monitor Cable	Memory	Display	Multi-touch	Storage(HDD/SSD)	Optical	Media Reader	WLAN + Bluetooth	Optional Rear Ports	Camera	Chassis Intrusion Switch	Keyboard / Mouse	Stand	Power Supply	Operating System	Warranty	Ann Date (m/y)
10EW000UUS	US	i5-6400	No	Intel HD 530	None	4GBx1	21.5" FHD (1920x1080) WVA AG	None	1TB 5400rpm 2.5"	DVD±RW	9-in-1	8260 ac, 2x2 + BT4.1	None	720p	Switch	USB / USB	UltraFlex II Stand	150W 85% Adapter	Win10 DG Win7 Pro 64	3-year, Onsite, OID	11/15
10EW000VUS	US	i5-6400	No	Intel HD 530	None	4GBx1	21.5" FHD (1920x1080) WVA AG	None	1TB 5400rpm 2.5"	DVD±RW	9-in-1	8260 ac, 2x2 + BT4.1	None	720p	Switch	USB / USB	UltraFlex II Stand	150W 85% Adapter	Win10 Pro 64	3-year, Onsite, OID	11/15
10EW000WUS	US	i5-6400	No	Intel HD 530	None	4GBx1	21.5" FHD (1920x1080) WVA AG	None	500GB 5400rpm 2.5"	DVD	None	8260 ac, 2x2 + BT4.1	None	720p	Switch	USB / USB	Basic Monitor Stand	150W 85% Adapter	Win10 DG Win7 Pro 64	3-year, Onsite, OID	11/15
10EW000XUS	US	i5-6400	No	Intel HD 530	None	4GBx1	21.5" FHD (1920x1080) WVA AG	None	500GB 5400rpm 2.5"	DVD	None	8260 ac, 2x2 + BT4.1	None	720p	Switch	USB / USB	Basic Monitor Stand	150W 85% Adapter	Win10 Pro 64	3-year, Onsite, OID	11/15

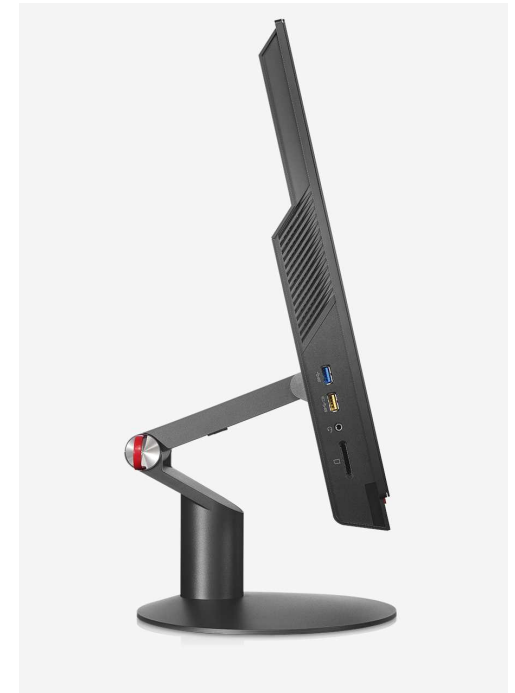
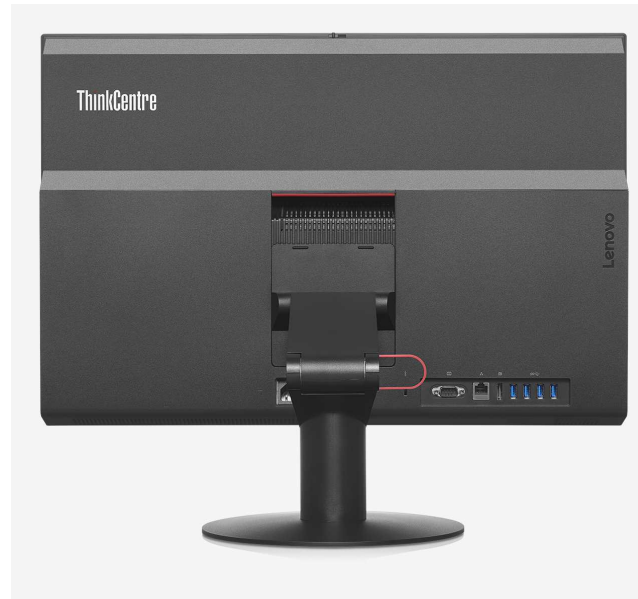
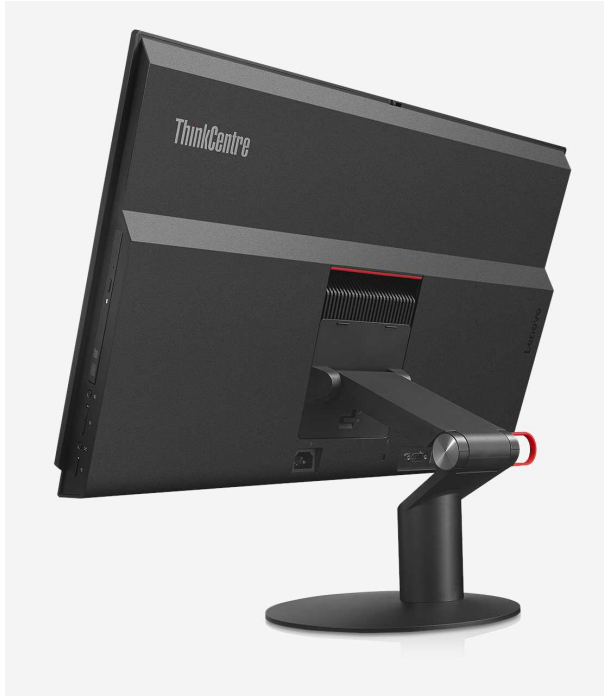

ThinkCentre M900z Platform Specifications

Product Specifications Reference (PSREF)

Processor	Intel® Celeron®, Intel Pentium®, or 6th Generation Intel Core™ i3 / i5 / i7 Processor							Security chip	Trusted Platform Module (TPM 1.2-compliant)																		
	Processor	Cores / Threads	Frequency Base/Max(GHz)	Cache	Memory Types	Integrated Graphics	Intel vPro	Security features	<ul style="list-style-type: none"> Security slot (in rear for attachment of Kensington lock also locks chassis) Power-on, admin, hard disk password Smart USB protection, allows keyboard/mouse only, blocks all storage devices Boot sequence control Boot without keyboard and mouse Individual USB port disablement Optional Chassis intrusion switch 																		
	Pentium G4400	2 / 2	3.3G	3 MB	DDR4-2133	HD 510	No																				
	Pentium G4500	2 / 2	3.5G	3 MB	DDR4-2133	HD 530	No																				
	Core i3-6100	2 / 4	3.7 G	3 MB	DDR4-2133	HD 530	No																				
	Core i3-6300	2 / 4	3.8 G	4 MB	DDR4-2133	HD 530	No																				
	Core i5-6400	4 / 4	2.7 G / 3.3 G	6 MB	DDR4-2133	HD 530	No																				
	Core i5-6500	4 / 4	3.2 G / 3.6 G	6 MB	DDR4-2133	HD 530	vPro																				
Core i5-6600	4 / 4	3.3 G / 3.9 G	6 MB	DDR4-2133	HD 530	vPro																					
Core i7-6700	4 / 8	3.4 G / 4.0 G	8 MB	DDR4-2133	HD 530	vPro																					
Memory	32GB max, DDR4 2133, two 260-pin SO-DIMM sockets, dual-channel capable							Keyboard	<i>Some:</i> Preferred Pro USB Keyboard (USB connector), Lenovo logo <i>Some:</i> Lenovo Slim USB Keyboard (USB connector), black <i>Some:</i> Ultralim Plus Wireless Keyboard (2.4GHz via USB receiver), black																		
Disk	<i>Some:</i> SATA 6.0Gb/s, 2.5" Wide, 5400 rpm or 7200 rpm <i>Some:</i> Solid State Hybrid Drive (SSHD) / with 8GB MLC NAND flash memory, SATA 6.0Gb/s, 2.5" Wide, 5400 rpm <i>Some:</i> Solid State Drive (SSD) / SATA 6.0Gb/s, 2.5" Wide							Mouse	<i>Some:</i> Enhanced Optical USB Mouse, black, Lenovo logo <i>Some:</i> Ultralim Plus Wireless Mouse (2.4GHz via USB receiver), black																		
Optical	<i>Some:</i> DVD, SATA 1.5Gb/s, 9.5mm high <i>Some:</i> DVD burner, SATA 1.5Gb/s, 9.5mm high							Mechanical	<ul style="list-style-type: none"> Business black color Toolless back cover, stand, disk, memory removal Support VESA mount (100mm) 																		
Media reader	Optional 9-in-1 media card reader								<table border="1"> <thead> <tr> <th></th> <th>Dimensions (WxDxH)</th> <th>Max weight (lb / kg)</th> <th>Adjustments</th> </tr> </thead> <tbody> <tr> <td>Without stand:</td> <td>23.0 X 1.8 X 15.4 (inch); 584 X 45 X 390 (mm)</td> <td>(Touch) 17.2 / 7.8 (Non-touch) 15.0 / 6.8</td> <td>N/A</td> </tr> <tr> <td>With Basic Monitor stand:</td> <td>23.0 X 9.6 X 18.0 (inch); 584 X 245 X 458 (mm)</td> <td>(Non-touch) 19.4 / 8.8</td> <td>Tilt: 45° back, -5° forward</td> </tr> <tr> <td>With UltraFlex II stand:</td> <td>23.0X 10.0 X 19.9 (inch); 584 X 253 X 505 (mm)</td> <td>(Touch) 22.7 / 10.3 (Non-touch) 20.7 / 9.4</td> <td>Tilt: 61° back, -5° forward; Lift: 160mm; Swivel: +/-45°</td> </tr> </tbody> </table>				Dimensions (WxDxH)	Max weight (lb / kg)	Adjustments	Without stand:	23.0 X 1.8 X 15.4 (inch); 584 X 45 X 390 (mm)	(Touch) 17.2 / 7.8 (Non-touch) 15.0 / 6.8	N/A	With Basic Monitor stand:	23.0 X 9.6 X 18.0 (inch); 584 X 245 X 458 (mm)	(Non-touch) 19.4 / 8.8	Tilt: 45° back, -5° forward	With UltraFlex II stand:	23.0X 10.0 X 19.9 (inch); 584 X 253 X 505 (mm)	(Touch) 22.7 / 10.3 (Non-touch) 20.7 / 9.4	Tilt: 61° back, -5° forward; Lift: 160mm; Swivel: +/-45°
	Dimensions (WxDxH)	Max weight (lb / kg)	Adjustments																								
Without stand:	23.0 X 1.8 X 15.4 (inch); 584 X 45 X 390 (mm)	(Touch) 17.2 / 7.8 (Non-touch) 15.0 / 6.8	N/A																								
With Basic Monitor stand:	23.0 X 9.6 X 18.0 (inch); 584 X 245 X 458 (mm)	(Non-touch) 19.4 / 8.8	Tilt: 45° back, -5° forward																								
With UltraFlex II stand:	23.0X 10.0 X 19.9 (inch); 584 X 253 X 505 (mm)	(Touch) 22.7 / 10.3 (Non-touch) 20.7 / 9.4	Tilt: 61° back, -5° forward; Lift: 160mm; Swivel: +/-45°																								
Graphics	Intel HD Graphics 510/530 in processor, uses main memory, DirectX® 12, external monitor support via DisplayPort™; <i>Max resolution:</i> 4096x2304 (DP)@60Hz							Power supply																			
Display	23.8" (604.5mm) Full HD 1080p (1920x1080) TFT color , WVA panel, wide viewing angle (+/- 89°), LED backlight, 250 nits, 16:9 aspect ratio, 1000:1 contrast ratio, anti-glare for both touch models and non-touch models, work as standalone monitor via DisplayPort (DP in / out combo)							150 watts, autosensing, 85% PSU Limited warranty ³ <i>Some:</i> 1-year or 3-year, depot repair service <i>Some:</i> 1-year or 3-year, limited onsite service <i>Some:</i> 3-years, limited onsite service, OID (Onsite International Delivery) / <i>For Lenovo service upgrade options, please go to S-TC sheet</i>																			
Light sensor	None							Preload	Preloaded operating system <i>Some:</i> Windows® 7 Professional 32/64 preinstalled through downgrade rights in Windows 10 Pro 64-bit <i>Some:</i> Windows 7 Professional 64 <i>Some:</i> Windows 10 Pro 64-bit <i>Some:</i> Windows 10 Home 64-bit																		
Multi-touch	Optional Projected Capacitive Touch (PCT) technology, supports 10-point touch								Preloaded applications (only some listed) <ul style="list-style-type: none"> Desktop Power Manager Lenovo Solution Center Lenovo REACHit Lenovo SHAREit Lenovo Bluetooth Lock (for models with Wi-Fi/BT card) McAfee® LiveSafe™ (30-day trial) Microsoft Office preloaded; purchase a product key to activate PowerDVD Create (DVD±RW) Lenovo ThinkVantage Tools - Only for Window 10 Lenovo Companion Cyberlink PowerDVD (DVD, DVD±RW) Lenovo QuickOptimizer - Only for Window 7 Rescue and Recovery Password Manager ThinkVantage System Update Lenovo Message Center Plus Adobe® Reader® 																		
Camera	Optional 2.0-megapixel camera, fixed focus, supports 1080p, with dual array digital microphone, LED indicator, physical switch on/off, Skype for Business certified							Environment																			
Controls	Microphone mute, monitor mode switch, brightness up/down buttons, and power button							EPEAT™ Gold rating; ENERGY STAR® 6.1; TCO Certified Edge; TUV Green Mark; ULE Gold; ErP Lot 3; GREENGUARD® certified; RoHS-compliant																			
Chipset	Intel Q170 Chipset							MIL-SPEC test	MIL-STD-810G military certification (Low Pressure [Altitude], High Temperature, Low Temperature, Temperature Shock, Humidity, Sand and Dust, Vibration, Shock)																		
Rear ports	Four USB 3.0, ethernet (RJ-45), DisplayPort in/out combo port, optional serial (9-pin),							Accessories	For compatible accessories, please go to TC-AQP sheet																		
Side ports	Two USB 3.0 (one is Always On and fast charge), optional card reader, one headphone / microphone combo jack (3.5mm)																										
M.2 card slot	One M.2 Card slot (for WLAN)																										
Audio support	High Definition (HD) Audio, Realtek ALC286 / two internal stereo speakers (3W x 2), Dolby® Audio™ certified, Skype for Business certified																										
WLAN ¹³	<i>Some:</i> 11ac wireless, M.2 Card, Qualcomm Atheros QCA9377 (dual band), Wi-Fi + Bluetooth 4.1 combo adapter, 1x1 <i>Some:</i> 11ac wireless, M.2 Card, Qualcomm Atheros QCA6174 (dual band), Wi-Fi + Bluetooth 4.1 combo adapter, 2x2 <i>Some:</i> 11ac wireless, M.2 Card, Intel Dual Band Wireless-AC 3165, Wi-Fi + Bluetooth 4.0 combo adapter, 1x1 <i>Some:</i> 11ac wireless, M.2 Card, Intel Dual Band Wireless-AC 8260, Wi-Fi + Bluetooth 4.1 combo adapter, 2x2 <i>Some:</i> 11ac wireless, M.2 Card, Intel Dual Band Wireless-AC 8260, Wi-Fi + Bluetooth 4.1 combo adapter, Intel vPro technology support, 2x2																										
Bluetooth™	<i>Some:</i> Bluetooth 4.0 or 4.1 wireless, integrated in Wi-Fi + Bluetooth combo adapter																										
Ethernet	Gigabit ethernet, Intel Ethernet Connection I219-LM (Jacksonville), Wake on LAN®																										
Manageability	Intel Active Management Technology 11.0 (Intel AMT 11.0); Intel vPro technology on some models (require choosing a vPro-support Wi-Fi adapter to enable vPro function through wireless connection)																										

See footnotes for more detailed information

Model	Region	Processor	vPro	Graphics	Monitor Cable	Memory	Display	Multi-touch	Storage(HDD/SSD)	Optical	Media Reader	WLAN + Bluetooth	Optional Rear Ports	Camera	Chassis Intrusion Switch	Keyboard / Mouse	Stand	Power Supply	Operating System	Warranty	Ann Date (m/y)
10F20005US	US	i7-6700	vPro	Intel HD 530	None	8GBx1	23.8" FHD (1920x1080) WVA AG	10-point Multi-touch	500GB 7200rpm 2.5"	DVD±RW	9-in-1	8260 ac, 2x2, vPro + BT4.1	None	1080p	Switch	USB / USB	UltraFlex II Stand	150W 85% Adapter	Win10 DG Win7 Pro 64	3-year, Onsite	11/15
10F20006US	US	i5-6500	vPro	Intel HD 530	None	8GBx1	23.8" FHD (1920x1080) WVA AG	10-point Multi-touch	500GB 7200rpm 2.5"	DVD±RW	9-in-1	8260 ac, 2x2, vPro + BT4.1	None	1080p	None	USB / USB	UltraFlex II Stand	150W 85% Adapter	Win10 DG Win7 Pro 64	3-year, Onsite	11/15
10F20008US	US	i5-6500	vPro	Intel HD 530	None	4GBx1	23.8" FHD (1920x1080) WVA AG	10-point Multi-touch	500GB 7200rpm 2.5"	DVD±RW	9-in-1	8260 ac, 2x2, vPro + BT4.1	None	1080p	None	USB / USB	UltraFlex II Stand	150W 85% Adapter	Win10 DG Win7 Pro 64	3-year, Onsite	11/15
10F20009US	US	i7-6700	vPro	Intel HD 530	None	4GBx1	23.8" FHD (1920x1080) WVA AG	10-point Multi-touch	500GB 7200rpm 2.5"	DVD±RW	9-in-1	8260 ac, 2x2, vPro + BT4.1	None	1080p	Switch	USB / USB	UltraFlex II Stand	150W 85% Adapter	Win10 DG Win7 Pro 64	3-year, Onsite	11/15
10F2000AUS	US	i5-6600	vPro	Intel HD 530	None	4GBx1	23.8" FHD (1920x1080) WVA AG	10-point Multi-touch	500GB 7200rpm 2.5"	DVD±RW	9-in-1	8260 ac, 2x2, vPro + BT4.1	None	1080p	None	USB / USB	UltraFlex II Stand	150W 85% Adapter	Win10 DG Win7 Pro 32	3-year, Onsite	11/15
10F2000YUS	US	i5-6500	vPro	Intel HD 530	None	4GBx1	23.8" FHD (1920x1080) WVA AG	10-point Multi-touch	500GB 7200rpm 2.5"	DVD±RW	9-in-1	8260 ac, 2x2, vPro + BT4.1	None	1080p	None	USB / USB	UltraFlex II Stand	150W 85% Adapter	Win10 Pro 64	3-year, Onsite	11/15
10F20010US	US	i7-6700	vPro	Intel HD 530	None	4GBx1	23.8" FHD (1920x1080) WVA AG	10-point Multi-touch	500GB 7200rpm 2.5"	DVD±RW	9-in-1	8260 ac, 2x2, vPro + BT4.1	None	1080p	None	USB / USB	UltraFlex II Stand	150W 85% Adapter	Win10 Pro 64	3-year, Onsite	11/15
10F2001BUS	US	i7-6700	vPro	Intel HD 530	None	4GBx2	23.8" FHD (1920x1080) WVA AG	10-point Multi-touch	128GB SSD	DVD±RW	9-in-1	8260 ac, 2x2, vPro + BT4.1	None	1080p	None	USB / USB	UltraFlex II Stand	150W 85% Adapter	Win10 Pro 64	1-year, Onsite	11/15
10F20022US	US	i5-6500	vPro	Intel HD 530	None	4GBx1	23.8" FHD (1920x1080) WVA AG	10-point Multi-touch	128GB SSD	DVD±RW	9-in-1	8260 ac, 2x2, vPro + BT4.1	None	1080p	None	USB / USB	UltraFlex II Stand	150W 85% Adapter	Win10 DG Win7 Pro 64	3-year, Onsite	03/16
10F20023US	US	i7-6700	vPro	Intel HD 530	None	4GBx1	23.8" FHD (1920x1080) WVA AG	10-point Multi-touch	128GB SSD	DVD±RW	9-in-1	8260 ac, 2x2, vPro + BT4.1	None	1080p	None	USB / USB	UltraFlex II Stand	150W 85% Adapter	Win10 Pro 64	3-year, Onsite	03/16
10F20024US	US	i7-6700	vPro	Intel HD 530	None	8GBx1	23.8" FHD (1920x1080) WVA AG	10-point Multi-touch	256GB SSD	DVD±RW	9-in-1	8260 ac, 2x2, vPro + BT4.1	None	1080p	None	USB / USB	UltraFlex II Stand	150W 85% Adapter	Win10 DG Win7 Pro 64	3-year, Onsite	03/16
10F20025US	US	i5-6500	vPro	Intel HD 530	None	4GBx1	23.8" FHD (1920x1080) WVA AG	10-point Multi-touch	128GB SSD	DVD±RW	9-in-1	8260 ac, 2x2, vPro + BT4.1	None	1080p	None	USB / USB	UltraFlex II Stand	150W 85% Adapter	Win10 Pro 64	3-year, Onsite	03/16
10F20026US	US	i7-6700	vPro	Intel HD 530	None	4GBx1	23.8" FHD (1920x1080) WVA AG	10-point Multi-touch	128GB SSD	DVD±RW	9-in-1	8260 ac, 2x2, vPro + BT4.1	None	1080p	None	USB / USB	UltraFlex II Stand	150W 85% Adapter	Win10 DG Win7 Pro 64	3-year, Onsite	03/16
10F20027US	US	i5-6500	vPro	Intel HD 530	None	8GBx1	23.8" FHD (1920x1080) WVA AG	10-point Multi-touch	256GB SSD	DVD±RW	9-in-1	8260 ac, 2x2, vPro + BT4.1	None	1080p	None	USB / USB	UltraFlex II Stand	150W 85% Adapter	Win10 Pro 64	3-year, Onsite	03/16
10F20028US	US	i5-6500	vPro	Intel HD 530	None	8GBx1	23.8" FHD (1920x1080) WVA AG	10-point Multi-touch	256GB SSD	DVD±RW	9-in-1	8260 ac, 2x2, vPro + BT4.1	None	1080p	None	USB / USB	UltraFlex II Stand	150W 85% Adapter	Win10 DG Win7 Pro 64	3-year, Onsite	03/16
10F20029US	US	i7-6700	vPro	Intel HD 530	None	8GBx1	23.8" FHD (1920x1080) WVA AG	10-point Multi-touch	256GB SSD	DVD±RW	9-in-1	8260 ac, 2x2, vPro + BT4.1	None	1080p	None	USB / USB	UltraFlex II Stand	150W 85% Adapter	Win10 Pro 64	3-year, Onsite	03/16
10F2002PUS	US	i7-6700	vPro	Intel HD 530	None	8GBx1	23.8" FHD (1920x1080) WVA AG	10-point Multi-touch	256GB SSD Opal	DVD±RW	9-in-1	8260 ac, 2x2, vPro + BT4.1	None	1080p	None	USB / USB	UltraFlex II Stand	150W 85% Adapter	Win10 DG Win7 Pro 64	3-year, Onsite	12/16
10F2002QUS	US	i5-6500	vPro	Intel HD 530	None	8GBx1	23.8" FHD (1920x1080) WVA AG	10-point Multi-touch	256GB SSD Opal	DVD±RW	9-in-1	8260 ac, 2x2, vPro + BT4.1	None	1080p	None	USB / USB	UltraFlex II Stand	150W 85% Adapter	Win10 Pro 64	3-year, Onsite	12/16
10F2002RUS	US	i5-6500	vPro	Intel HD 530	None	8GBx1	23.8" FHD (1920x1080) WVA AG	10-point Multi-touch	256GB SSD Opal	DVD±RW	9-in-1	8260 ac, 2x2, vPro + BT4.1	None	1080p	None	USB / USB	UltraFlex II Stand	150W 85% Adapter	Win10 DG Win7 Pro 64	3-year, Onsite	12/16
10F2002SUS	US	i7-6700	vPro	Intel HD 530	None	8GBx1	23.8" FHD (1920x1080) WVA AG	10-point Multi-touch	256GB SSD Opal	DVD±RW	9-in-1	8260 ac, 2x2, vPro + BT4.1	None	1080p	None	USB / USB	UltraFlex II Stand	150W 85% Adapter	Win10 Pro 64	3-year, Onsite	12/16

Model	Region	Processor	vPro	Graphics	Monitor Cable	Memory	Display	Multi-touch	Storage(HDD/SSD)	Optical	Media Reader	WLAN + Bluetooth	Optional Rear Ports	Camera	Chassis Intrusion Switch	Keyboard / Mouse	Stand	Power Supply	Operating System	Warranty	Ann Date (m/y)
10F30005US	US	i5-6500	vPro	Intel HD 530	None	4GBx1	23.8" FHD (1920x1080) WVA AG	None	500GB 7200rpm 2.5"	DVD±RW	9-in-1	8260 ac, 2x2, vPro + BT4.1	None	1080p	None	USB / USB	UltraFlex II Stand	150W 85% Adapter	Win10 DG Win7 Pro 64	3-year, Onsite	11/15
10F30006US	US	i5-6500	vPro	Intel HD 530	None	8GBx1	23.8" FHD (1920x1080) WVA AG	None	500GB 7200rpm 2.5"	DVD±RW	9-in-1	8260 ac, 2x2, vPro + BT4.1	None	1080p	None	USB / USB	UltraFlex II Stand	150W 85% Adapter	Win10 DG Win7 Pro 64	3-year, Onsite	11/15
10F30009US	US	i5-6500	vPro	Intel HD 530	None	4GBx1	23.8" FHD (1920x1080) WVA AG	None	500GB 7200rpm 2.5"	DVD±RW	9-in-1	8260 ac, 2x2, vPro + BT4.1	None	1080p	None	USB / USB	UltraFlex II Stand	150W 85% Adapter	Win10 Pro 64	3-year, Onsite	11/15
10F3000AUS	US	i7-6700	vPro	Intel HD 530	None	4GBx1	23.8" FHD (1920x1080) WVA AG	None	500GB 7200rpm 2.5"	DVD±RW	9-in-1	8260 ac, 2x2, vPro + BT4.1	None	1080p	None	USB / USB	UltraFlex II Stand	150W 85% Adapter	Win10 Pro 64	3-year, Onsite	11/15
10F3001FUS	US	i7-6700	vPro	Intel HD 530	None	4GBx1	23.8" FHD (1920x1080) WVA AG	None	128GB SSD	DVD±RW	9-in-1	8260 ac, 2x2, vPro + BT4.1	None	1080p	None	USB / USB	UltraFlex II Stand	150W 85% Adapter	Win10 Pro 64	3-year, Onsite	05/16
10F3001GUS	US	i5-6500	vPro	Intel HD 530	None	4GBx1	23.8" FHD (1920x1080) WVA AG	None	128GB SSD	DVD±RW	9-in-1	8260 ac, 2x2, vPro + BT4.1	None	1080p	None	USB / USB	UltraFlex II Stand	150W 85% Adapter	Win10 Pro 64	3-year, Onsite	05/16
10F3001HUS	US	i7-6700	vPro	Intel HD 530	None	8GBx1	23.8" FHD (1920x1080) WVA AG	None	256GB SSD	DVD±RW	9-in-1	8260 ac, 2x2, vPro + BT4.1	None	1080p	None	USB / USB	UltraFlex II Stand	150W 85% Adapter	Win10 Pro 64	3-year, Onsite	05/16
10F3001JUS	US	i5-6500	vPro	Intel HD 530	None	8GBx1	23.8" FHD (1920x1080) WVA AG	None	256GB SSD	DVD±RW	9-in-1	8260 ac, 2x2, vPro + BT4.1	None	1080p	None	USB / USB	UltraFlex II Stand	150W 85% Adapter	Win10 Pro 64	3-year, Onsite	05/16
10F30023US	US	i7-6700	vPro	Intel HD 530	None	8GBx1	23.8" FHD (1920x1080) WVA AG	None	256GB SSD Opal	DVD±RW	9-in-1	8260 ac, 2x2, vPro + BT4.1	None	1080p	None	USB / USB	UltraFlex II Stand	150W 85% Adapter	Win10 Pro 64	3-year, Onsite	12/16
10F30024US	US	i5-6500	vPro	Intel HD 530	None	8GBx1	23.8" FHD (1920x1080) WVA AG	None	256GB SSD Opal	DVD±RW	9-in-1	8260 ac, 2x2, vPro + BT4.1	None	1080p	None	USB / USB	UltraFlex II Stand	150W 85% Adapter	Win10 Pro 64	3-year, Onsite	12/16

Model	Region	Processor	vPro	Graphics	Monitor Cable	Memory	Display	Multi-touch	Storage(HDD/SSD)	Optical	Media Reader	WLAN + Bluetooth	Optional Rear Ports	Camera	Chassis Intrusion Switch	Keyboard / Mouse	Stand	Power Supply	Operating System	Warranty	Ann Date (m/y)
10F40013US	US	i7-6700	vPro	Intel HD 530	None	4GBx2	23.8" FHD (1920x1080) WVA AG	10-point Multi-touch	128GB SSD	DVD±RW	9-in-1	8260 ac, 2x2, vPro + BT4.1	None	1080p	Switch	2.4G / 2.4G	UltraFlex II Stand	150W 85% Adapter	Win10 Pro 64	3-year, Onsite, OID	11/15
10F40014US	US	i7-6700	vPro	Intel HD 530	None	4GBx2	23.8" FHD (1920x1080) WVA AG	10-point Multi-touch	128GB SSD	DVD±RW	9-in-1	8260 ac, 2x2, vPro + BT4.1	None	1080p	Switch	2.4G / 2.4G	UltraFlex II Stand	150W 85% Adapter	Win10 DG Win7 Pro 64	3-year, Onsite, OID	11/15

Model	Region	Processor	vPro	Graphics	Monitor Cable	Memory	Display	Multi-touch	Storage(HDD/SSD)	Optical	Media Reader	WLAN + Bluetooth	Optional Rear Ports	Camera	Chassis Intrusion Switch	Keyboard / Mouse	Stand	Power Supply	Operating System	Warranty	Ann Date (m/y)
10F5000XUS	US	i5-6500	vPro	Intel HD 530	None	4GBx1	23.8" FHD (1920x1080) WVA AG	None	1TB 5400rpm 2.5"	DVD±RW	9-in-1	8260 ac, 2x2, vPro + BT4.1	None	1080p	None	USB / USB	UltraFlex II Stand	150W 85% Adapter	Win10 Pro 64	3-year, Onsite, OID	11/15
10F5000YUS	US	i5-6500	vPro	Intel HD 530	None	4GBx1	23.8" FHD (1920x1080) WVA AG	None	1TB 5400rpm 2.5"	DVD±RW	9-in-1	8260 ac, 2x2, vPro + BT4.1	None	1080p	Switch	USB / USB	UltraFlex II Stand	150W 85% Adapter	Win10 DG Win7 Pro 64	3-year, Onsite, OID	11/15



ThinkCentre M600 Tiny Platform Specifications

Product Specifications Reference (PSREF)

Processor	Intel® Celeron® Processor N3000 Series or Intel Pentium® Processor N3000 Series						Keyboard	<i>Some:</i> PS/2 Keyboard (PS/2 connector), Lenovo logo <i>Some:</i> Preferred Pro USB Keyboard (USB connector), Lenovo logo <i>Some:</i> Lenovo USB Fingerprint Keyboard (USB connector) <i>Some:</i> Ultralim Plus Wireless Keyboard (2.4GHz via USB receiver), black			
	Processor	Cores / Threads	Frequency (Base/Max)	Cache	Memory Types	Integrated Graphics	Mouse	<i>Some:</i> PS/2 Optical Wheel Mouse, black, Lenovo logo <i>Some:</i> Enhanced Optical USB Mouse, black, Lenovo logo <i>Some:</i> Ultralim Plus Wireless Mouse (2.4GHz via USB receiver), black			
	Celeron N3000	2 / 2	1.04 / 2.08 GHz	2MB	DDR3L-1600	Intel HD					
	Celeron N3010	2 / 2	1.04 / 2.24 GHz	2MB	DDR3L-1600	Intel HD 400					
	Celeron N3050	2 / 2	1.6 / 2.16 GHz	2MB	DDR3L-1600	Intel HD					
	Pentium N3700	4 / 4	1.6 / 2.4 GHz	2MB	DDR3L-1600	Intel HD					
	Pentium J3710	4 / 4	1.6 / 2.64 GHz	2MB	DDR3L-1600	Intel HD 405					
Chipset	Intel Architecture (IA) SoC that integrates Intel processor core, graphics, memory controller, and I/O interfaces into a single system-on-chip solution						Mechanical	<ul style="list-style-type: none"> Tiny (1L or 2L), black color; metal case 			
Graphics	Intel HD Graphics in processor, uses main memory, DirectX® 11.1, twoDisplayPort™, one optional 3rd DP or VGA, supports triple independent display; Maximum resolution: 3840x2160(DP)@30Hz; 1920x1200(optional VGA)@60Hz; 1920x1080(DP to VGA dongle)@60Hz; 1920x1080(DP to DVI dongle)@60Hz; 3840x2160(DP to HDMI dongle)@30Hz										
Monitor cable	Optional DP to VGA, DP to DVI-D (single link), or DP to HDMI 1.4 dongle										
Memory	8GB max / DDR3 Low Voltage, DDR3L-1600, non-parity, one 204-pin SO-DIMM socket										
Storage	<i>Some:</i> M.2 Solid State Drive (SSD), SATA interface <i>Some:</i> hard disk, 5400 or 7200 rpm, SATA 6.0Gb/s, 2.5" Wide <i>Some:</i> 500GB (5400 rpm) Solid State Hybrid Drive (SSHD) / with 8GB MLC NAND flash memory, SATA 6.0Gb/s, 2.5" wide						VESA mount	Optional VESA mount bracket kit, supports VESA 75mm and 100mm			
	<i>Some:</i> Solid State Drive (SSD) / SATA 6.0Gb/s, 2.5" Wide <i>Some:</i> external ODD box with DVD-ROM, 9.5mm high, via USB <i>Some:</i> external ODD box with DVD±RW, 9.5mm high, via USB <i>Some:</i> external ODD box (for TIO) with DVD-ROM, 9.5mm high, via USB <i>Some:</i> external ODD box (for TIO) with DVD±RW, 9.5mm high, via USB						Floor Stand	Optional system floor stand for vertical orientation			
Optical	<i>Some:</i> external ODD box (for TIO) with DVD-ROM, 9.5mm high, via USB <i>Some:</i> external ODD box (for TIO) with DVD±RW, 9.5mm high, via USB						Power supply	65 watts AC/DC adapter, autosensing, 88% PSU (not included for TIO models) 90 watts AC/DC adapter, autosensing, 88% PSU (only for models with I/O box)			
Onboard SATA	SATA 6.0Gb/s controller, one connectors on planar						Limited warranty ³	<i>Some:</i> 1-year or 3-year, depot service / service upgrades available <i>Some:</i> 1-year or 3-year, limited onsite service / service upgrades available <i>Some:</i> 3-year, limited onsite service, OID (Onsite International Delivery) / service upgrades available <i>For Lenovo service upgrade options, please go to S-TC sheet</i>			
Media reader	None						Preload	<i>Some:</i> Windows® 7 Professional 64 preinstalled through downgrade rights in Windows 10 Pro 64-bit <i>Some:</i> Windows 7 Professional 64 <i>Some:</i> Windows 10 Pro 64-bit <i>Some:</i> Windows 10 Home 64-bit Preloaded applications (only some listed) <ul style="list-style-type: none"> Desktop Power Manager Lenovo Solution Center Lenovo REACHit Lenovo SHAREit Lenovo Bluetooth Lock McAfee® LiveSafe™ (30-day trial) Microsoft Office preloaded; purchase a product key to activate PowerDVD Create (DVD±RW) Lenovo ThinkVantage Tools - Only for Window 10 Lenovo Companion (Win10) Cyberlink PowerDVD (DVD, DVD±RW) Lenovo QuickOptimizer - Only for Window 7 Rescue and Recovery Password Manager ThinkVantage System Update Lenovo Message Center Plus Adobe® Reader® 			
Front ports	Two USB 3.0 (one is Always On and fast charge), one microphone (stereo, 3.5mm), one headphone / microphone combo jack (stereo, 3.5mm)										
Rear ports	Two USB 2.0, two USB 3.0 (optional external optical box or I/O box occupies one or two specific USB on some models), ethernet (RJ-45), two DisplayPort, one optional port (VGA, 3rd DP, or serial on some models), one headphone; additional four serial (9-pin), one parallel (25-pin), and two PS/2 ports on 2L models										
I/O box	Optional external I/O box, extends two USB 2.0, two USB 3.0, and one serial on rear, two USB 2.0 on front, via USB (occupy two specific USB 3.0 of M600 Tiny)										
Audio support	High Definition (HD) Audio, Realtek ALC223 / optional internal speaker (1 watt)										
WLAN ¹³	<i>Some:</i> 11ac wireless, M.2 Card, Realtek RTL8821AE (dual band), Wi-Fi + Bluetooth 4.0 combo adapter, 1x1 <i>Some:</i> 11ac wireless, M.2 Card, Qualcomm Atheros QCA9377 (dual band), Wi-Fi + Bluetooth 4.1 combo adapter, 1x1 <i>Some:</i> 11ac wireless, M.2 Card, Qualcomm Atheros QCA6174 (dual band), Wi-Fi + Bluetooth 4.1 combo adapter, 2x2 <i>Some:</i> 11ac wireless, M.2 Card, Intel Dual Band Wireless-AC 3165, Wi-Fi + Bluetooth 4.0 combo adapter, 1x1 <i>Some:</i> 11ac wireless, M.2 Card, Intel Dual Band Wireless-AC 8260, Wi-Fi + Bluetooth 4.1 combo adapter, 2x2										
Bluetooth™	<i>Some:</i> Bluetooth 4.0 or 4.1 wireless, integrated in Wi-Fi + BT combo adapter										
Ethernet	One gigabit ethernet port, Realtek RTL8111GN, Wake on LAN®										
Modem	None										
Manageability	None						Environment	ENERGY STAR® 6.0*, EPEAT™ Gold rating* (*for Windows models only); GREENGUARD®; RoHS-compliant; Cisco EnergyWise compatible; ErP Lot 3			
Security chip	Trusted Platform Module, TCG 1.2-compliant						Accessories	For compatible accessories, please go to TC-AQP sheet			
Security features	<ul style="list-style-type: none"> Security slot (in rear for optional Kensington® MicroSaver® cable) Padlock loop Smart USB protection, allows keyboard/mouse only, blocks all storage devices Power-on password Administrator password Hard disk password Boot sequence control Boot without keyboard and mouse Individual USB port disablement Chassis intrusion switch 										

See footnotes for more detailed information

Model	Region	Case 1L/2L	Processor	vPro	Graphics	Monitor Cable	Memory	Storage	External Optical / I/O Box	WLAN + Bluetooth	Optional Rear Ports	Chassis Intrusion Switch	Kensington Cable Lock	Speaker	Adapter Cage	Toolless Chassis Screw	Keyboard / Mouse	VESA Mount	Stand	Power Supply	Operating System	Warranty	Ann Date (m/y)
10G9000NUS	US	1L	Pentium N3700	No	Intel HD	None	4GBx1	500GB 7200rpm 2.5"	None	Intel 8260 ac, 2x2 + BT4.1	None	Switch	None	1Wx1	None	None	USB / USB	None	Floor Stand	65W Adapter 88%	Win10 DG Win7 Pro 64	1-year, Onsite	10/15
10G9000XUS	US	1L	Pentium N3700	No	Intel HD	None	4GBx1	500GB 7200rpm 2.5"	None	Intel 3165 ac, 1x1 + BT4.0	VGA	Switch	None	1Wx1	None	None	USB / USB	None	Floor Stand	65W Adapter 88%	Win10 DG Win7 Pro 64	1-year, Onsite	05/16
10G9000YUS	US	1L	Pentium N3700	No	Intel HD	None	4GBx1	500GB 7200rpm 2.5"	None	Intel 3165 ac, 1x1 + BT4.0	3rd DP	Switch	None	1Wx1	None	None	USB / USB	None	Floor Stand	65W Adapter 88%	Win10 Pro 64	1-year, Onsite	05/16
10G90010US	US	1L	Pentium N3700	No	Intel HD	None	4GBx1	500GB 7200rpm 2.5"	None	Intel 3165 ac, 1x1 + BT4.0	Serial	Switch	None	1Wx1	None	None	USB / USB	None	Floor Stand	65W Adapter 88%	Win10 Pro 64	1-year, Onsite	05/16
10G90011US	US	1L	Pentium N3700	No	Intel HD	None	4GBx1	128GB SSD	None	Intel 3165 ac, 1x1 + BT4.0	None	Switch	None	1Wx1	None	None	USB / USB	None	Floor Stand	65W Adapter 88%	Win10 Pro 64	1-year, Onsite	05/16
10G90012US	US	1L	Pentium N3700	No	Intel HD	None	4GBx1	500GB 7200rpm 2.5"	None	Intel 3165 ac, 1x1 + BT4.0	None	Switch	None	1Wx1	None	None	USB / USB	None	Floor Stand	65W Adapter 88%	Win10 Pro 64	1-year, Onsite	05/16
10G90013US	US	1L	Pentium N3700	No	Intel HD	None	4GBx1	128GB SSD	None	Intel 3165 ac, 1x1 + BT4.0	None	Switch	None	1Wx1	None	None	USB / USB	None	Floor Stand	65W Adapter 88%	Win10 DG Win7 Pro 64	1-year, Onsite	05/16
10G90014US	US	1L	Pentium N3700	No	Intel HD	None	4GBx1	500GB 7200rpm 2.5"	None	Intel 3165 ac, 1x1 + BT4.0	None	Switch	None	1Wx1	None	None	USB / USB	None	Floor Stand	65W Adapter 88%	Win10 DG Win7 Pro 64	1-year, Onsite	05/16
10G90015US	US	1L	Pentium N3700	No	Intel HD	None	4GBx1	500GB 7200rpm 2.5"	None	Intel 3165 ac, 1x1 + BT4.0	VGA	Switch	None	1Wx1	None	None	USB / USB	None	Floor Stand	65W Adapter 88%	Win10 Pro 64	1-year, Onsite	05/16
10G90016US	US	1L	Pentium N3700	No	Intel HD	None	4GBx1	500GB 7200rpm 2.5"	None	Intel 3165 ac, 1x1 + BT4.0	3rd DP	Switch	None	1Wx1	None	None	USB / USB	None	Floor Stand	65W Adapter 88%	Win10 DG Win7 Pro 64	1-year, Onsite	05/16
10G9001CUS	US	1L	Pentium J3710	No	Intel HD 405	None	4GBx1	128GB SSD	None	Intel 8260 ac, 2x2 + BT4.1	3rd DP	Switch	None	1Wx1	None	None	USB / USB	None	Floor Stand	65W Adapter 88%	Win10 Pro 64	1-year, Onsite	07/16
10G9001DUS	US	1L	Pentium J3710	No	Intel HD 405	None	4GBx1	500GB 7200rpm 2.5"	None	Intel 3165 ac, 1x1 + BT4.0	3rd DP	Switch	None	1Wx1	None	None	USB / USB	None	Floor Stand	65W Adapter 88%	Win10 Pro 64	1-year, Onsite	07/16
10G9001EUS	US	1L	Pentium J3710	No	Intel HD 405	None	4GBx1	500GB 7200rpm 2.5"	None	Intel 3165 ac, 1x1 + BT4.0	VGA	Switch	None	1Wx1	None	None	USB / USB	None	Floor Stand	65W Adapter 88%	Win10 Pro 64	1-year, Onsite	07/16
10G9001FUS	US	1L	Pentium J3710	No	Intel HD 405	None	4GBx1	500GB 7200rpm 2.5"	None	Intel 3165 ac, 1x1 + BT4.0	None	Switch	None	1Wx1	None	None	USB / USB	None	Floor Stand	65W Adapter 88%	Win10 Pro 64	1-year, Onsite	07/16
10G9001GUS	US	1L	Pentium J3710	No	Intel HD 405	None	4GBx1	128GB SSD	None	Intel 3165 ac, 1x1 + BT4.0	None	Switch	None	1Wx1	None	None	USB / USB	None	Floor Stand	65W Adapter 88%	Win10 Pro 64	1-year, Onsite	07/16
10G9001HUS	US	1L	Pentium J3710	No	Intel HD 405	None	4GBx1	500GB 7200rpm 2.5"	None	Intel 3165 ac, 1x1 + BT4.0	Serial	Switch	None	1Wx1	None	None	USB / USB	None	Floor Stand	65W Adapter 88%	Win10 Pro 64	1-year, Onsite	07/16
10G9001QUS	US	1L	Pentium J3710	No	Intel HD 405	None	4GBx1	500GB 7200rpm 2.5"	None	Intel 8260 ac, 2x2 + BT4.1	3rd DP	Switch	None	1Wx1	None	None	USB / USB	None	Floor Stand	65W Adapter 88%	Win10 DG Win7 Pro 64	1-year, Onsite	09/16
10G9001RUS	US	1L	Pentium J3710	No	Intel HD 405	None	4GBx1	128GB SSD	None	Intel 3165 ac, 1x1 + BT4.0	None	Switch	None	1Wx1	None	None	USB / USB	None	Floor Stand	65W Adapter 88%	Win10 DG Win7 Pro 64	1-year, Onsite	09/16
10G9001SUS	US	1L	Pentium J3710	No	Intel HD 405	None	4GBx1	500GB 7200rpm 2.5"	None	Intel 3165 ac, 1x1 + BT4.0	3rd DP	Switch	None	1Wx1	None	None	USB / USB	None	Floor Stand	65W Adapter 88%	Win10 DG Win7 Pro 64	1-year, Onsite	09/16
10G9001TUS	US	1L	Pentium J3710	No	Intel HD 405	None	4GBx1	128GB SSD	None	Intel 8260 ac, 2x2 + BT4.1	3rd DP	Switch	None	1Wx1	None	None	USB / USB	None	Floor Stand	65W Adapter 88%	Win10 DG Win7 Pro 64	1-year, Onsite	09/16

Model	Region	Case 1L/2L	Processor	vPro	Graphics	Monitor Cable	Memory	Storage	External Optical / I/O Box	WLAN + Bluetooth	Optional Rear Ports	Chassis Intrusion Switch	Kensington Cable Lock	Speaker	Adapter Cage	Toolless Chassis Screw	Keyboard / Mouse	VESA Mount	Stand	Power Supply	Operating System	Warranty	Ann Date (m/y)
10G9001UUS	US	1L	Pentium J3710	No	Intel HD 405	None	4GBx1	500GB 7200rpm 2.5"	None	Intel 3165 ac, 1x1 + BT4.0	None	Switch	None	1Wx1	None	None	USB / USB	None	Floor Stand	65W Adapter 88%	Win10 DG Win7 Pro 64	1-year, Onsite	09/16
10G9001VUS	US	1L	Pentium J3710	No	Intel HD 405	None	4GBx1	500GB 7200rpm 2.5"	None	Intel 3165 ac, 1x1 + BT4.0	Serial	Switch	None	1Wx1	None	None	USB / USB	None	Floor Stand	65W Adapter 88%	Win10 DG Win7 Pro 64	1-year, Onsite	09/16
10G9001WUS	US	1L	Pentium J3710	No	Intel HD 405	None	4GBx1	500GB 7200rpm 2.5"	None	Intel 3165 ac, 1x1 + BT4.0	VGA	Switch	None	1Wx1	None	None	USB / USB	None	Floor Stand	65W Adapter 88%	Win10 DG Win7 Pro 64	1-year, Onsite	09/16

ThinkCentre M600 Tiny - TopSeller - 10GB

Product Specifications Reference (PSREF)

Model	Region	Case 1L/2L	Processor	vPro	Graphics	Monitor Cable	Memory	Storage	External Optical / I/O Box	WLAN + Bluetooth	Optional Rear Ports	Chassis Intrusion Switch	Kensington Cable Lock	Speaker	Adapter Cage	Toolless Chassis Screw	Keyboard / Mouse	VESA Mount	Stand	Power Supply	Operating System	Warranty	Ann Date (m/y)
10GB000JUS	US	1L	Celeron N3050	No	Intel HD	None	4GBx1	500GB 7200rpm 2.5"	None	Intel 8260 ac, 2x2 + BT4.1	None	Switch	None	1Wx1	None	None	USB / USB	None	Floor Stand	65W Adapter 88%	Win10 Pro 64	3-year, Onsite	10/15
10GB000KUS	US	1L	Celeron N3050	No	Intel HD	None	4GBx1	500GB 7200rpm 2.5"	None	Intel 8260 ac, 2x2 + BT4.1	None	Switch	None	1Wx1	None	None	USB / USB	None	Floor Stand	65W Adapter 88%	Win10 DG Win7 Pro 64	3-year, Onsite	10/15
10GB000LUS	US	1L	Celeron N3050	No	Intel HD	None	4GBx1	120GB SSD	None	Intel 8260 ac, 2x2 + BT4.1	None	Switch	None	1Wx1	None	None	USB / USB	None	Floor Stand	65W Adapter 88%	Win10 DG Win7 Pro 64	3-year, Onsite	10/15
10GB000MUS	US	1L	Celeron N3050	No	Intel HD	None	4GBx1	120GB SSD	None	Intel 8260 ac, 2x2 + BT4.1	None	Switch	None	1Wx1	None	None	USB / USB	None	Floor Stand	65W Adapter 88%	Win10 Pro 64	3-year, Onsite	10/15

Model	Region	Case 1L/2L	Processor	vPro	Graphics	Monitor Cable	Memory	Storage	External Optical / I/O Box	WLAN + Bluetooth	Optional Rear Ports	Chassis Intrusion Switch	Kensington Cable Lock	Speaker	Adapter Cage	Toolless Chassis Screw	Keyboard / Mouse	VESA Mount	Stand	Power Supply	Operating System	Warranty	Ann Date (m/y)
10KH0001US	US	1L	Celeron N3000	No	Intel HD	None	2GBx1	16GB SSD M.2	None	RTL8821AE ac, 1x1 + BT4.0	None	Switch	None	1Wx1	None	None	USB / USB	None	Floor Stand	65W Adapter 88%	WES 7	1-year, Onsite	01/16
10KH0002US	US	1L	Celeron N3000	No	Intel HD	None	4GBx1	16GB SSD M.2	None	RTL8821AE ac, 1x1 + BT4.0	None	Switch	None	1Wx1	None	None	USB / USB	None	Floor Stand	65W Adapter 88%	WES 7	3-year, Onsite	01/16
10KH0003US	US	1L	Celeron N3000	No	Intel HD	None	4GBx1	16GB SSD M.2	None	RTL8821AE ac, 1x1 + BT4.0	VGA	Switch	None	1Wx1	None	None	USB / USB	None	Floor Stand	65W Adapter 88%	WES 7	1-year, Onsite	01/16
10KH0004US	US	1L	Celeron N3000	No	Intel HD	None	4GBx1	16GB SSD M.2	None	RTL8821AE ac, 1x1 + BT4.0	VGA	Switch	None	1Wx1	None	None	USB / USB	None	Floor Stand	65W Adapter 88%	WES 7	3-year, Onsite	01/16
10KH0005US	US	1L	Celeron N3000	No	Intel HD	None	2GBx1	16GB SSD M.2	None	RTL8821AE ac, 1x1 + BT4.0	None	Switch	None	1Wx1	None	None	USB / USB	None	Floor Stand	65W Adapter 88%	WES 7	3-year, Onsite	01/16
10KH0006US	US	1L	Celeron N3000	No	Intel HD	None	4GBx1	16GB SSD M.2	None	RTL8821AE ac, 1x1 + BT4.0	3rd DP	Switch	None	1Wx1	None	None	USB / USB	None	Floor Stand	65W Adapter 88%	WES 7	3-year, Onsite	01/16
10KH0007US	US	1L	Celeron N3000	No	Intel HD	None	4GBx1	16GB SSD M.2	None	RTL8821AE ac, 1x1 + BT4.0	None	Switch	None	1Wx1	None	None	USB / USB	None	Floor Stand	65W Adapter 88%	WES 7	1-year, Onsite	01/16
10KH0008US	US	1L	Celeron N3000	No	Intel HD	None	4GBx1	16GB SSD M.2	None	RTL8821AE ac, 1x1 + BT4.0	3rd DP	Switch	None	1Wx1	None	None	USB / USB	None	Floor Stand	65W Adapter 88%	WES 7	1-year, Onsite	01/16
10KH0009US	US	1L	Celeron N3000	No	Intel HD	None	4GBx1	16GB SSD M.2	None	RTL8821AE ac, 1x1 + BT4.0	None	Switch	None	1Wx1	None	None	USB / USB	None	Floor Stand	65W Adapter 88%	LeTOS	3-year, Onsite	01/16
10KH000AUS	US	1L	Celeron N3000	No	Intel HD	None	4GBx1	16GB SSD M.2	None	RTL8821AE ac, 1x1 + BT4.0	Serial	Switch	None	1Wx1	None	None	USB / USB	None	Floor Stand	65W Adapter 88%	WES 7	3-year, Onsite	01/16
10KH000BUS	US	1L	Celeron N3000	No	Intel HD	None	2GBx1	16GB SSD M.2	None	RTL8821AE ac, 1x1 + BT4.0	None	Switch	None	1Wx1	None	None	USB / USB	None	Floor Stand	65W Adapter 88%	LeTOS	1-year, Onsite	01/16
10KH000CUS	US	1L	Celeron N3000	No	Intel HD	None	4GBx1	16GB SSD M.2	None	RTL8821AE ac, 1x1 + BT4.0	3rd DP	Switch	None	1Wx1	None	None	USB / USB	None	Floor Stand	65W Adapter 88%	LeTOS	1-year, Onsite	01/16
10KH000DUS	US	1L	Celeron N3000	No	Intel HD	None	4GBx1	16GB SSD M.2	None	RTL8821AE ac, 1x1 + BT4.0	Serial	Switch	None	1Wx1	None	None	USB / USB	None	Floor Stand	65W Adapter 88%	LeTOS	3-year, Onsite	01/16
10KH000EUS	US	1L	Celeron N3000	No	Intel HD	None	2GBx1	16GB SSD M.2	None	RTL8821AE ac, 1x1 + BT4.0	None	Switch	None	1Wx1	None	None	USB / USB	None	Floor Stand	65W Adapter 88%	LeTOS	3-year, Onsite	01/16
10KH000FUS	US	1L	Celeron N3000	No	Intel HD	None	4GBx1	16GB SSD M.2	None	RTL8821AE ac, 1x1 + BT4.0	None	Switch	None	1Wx1	None	None	USB / USB	None	Floor Stand	65W Adapter 88%	LeTOS	1-year, Onsite	01/16
10KH000GUS	US	1L	Celeron N3000	No	Intel HD	None	4GBx1	16GB SSD M.2	None	RTL8821AE ac, 1x1 + BT4.0	3rd DP	Switch	None	1Wx1	None	None	USB / USB	None	Floor Stand	65W Adapter 88%	LeTOS	3-year, Onsite	01/16
10KH0023US	US	1L	Celeron N3010	No	Intel HD 400	None	2GBx1	16GB SSD M.2	None	RTL8821AE ac, 1x1 + BT4.0	None	Switch	None	1Wx1	None	None	USB / USB	None	Floor Stand	65W Adapter 88%	LeTOS	1-year, Onsite	07/16
10KH0024US	US	1L	Celeron N3010	No	Intel HD 400	None	4GBx1	16GB SSD M.2	None	RTL8821AE ac, 1x1 + BT4.0	VGA	Switch	None	1Wx1	None	None	USB / USB	None	Floor Stand	65W Adapter 88%	LeTOS	1-year, Onsite	07/16
10KH0025US	US	1L	Celeron N3010	No	Intel HD 400	None	4GBx1	16GB SSD M.2	None	RTL8821AE ac, 1x1 + BT4.0	None	Switch	None	1Wx1	None	None	USB / USB	None	Floor Stand	65W Adapter 88%	WES 7	1-year, Onsite	07/16
10KH0026US	US	1L	Celeron N3010	No	Intel HD 400	None	4GBx1	16GB SSD M.2	None	RTL8821AE ac, 1x1 + BT4.0	VGA	Switch	None	1Wx1	None	None	USB / USB	None	Floor Stand	65W Adapter 88%	WES 7	1-year, Onsite	07/16

Model	Region	Case 1L/2L	Processor	vPro	Graphics	Monitor Cable	Memory	Storage	External Optical / I/O Box	WLAN + Bluetooth	Optional Rear Ports	Chassis Intrusion Switch	Kensington Cable Lock	Speaker	Adapter Cage	Toolless Chassis Screw	Keyboard / Mouse	VESA Mount	Stand	Power Supply	Operating System	Warranty	Ann Date (m/y)
10KH0027US	US	1L	Celeron N3010	No	Intel HD 400	None	4GBx1	16GB SSD M.2	None	RTL8821AE ac, 1x1 + BT4.0	Serial	Switch	None	1Wx1	None	None	USB / USB	None	Floor Stand	65W Adapter 88%	LeTOS	1-year, Onsite	07/16
10KH0028US	US	1L	Celeron N3010	No	Intel HD 400	None	4GBx1	16GB SSD M.2	None	RTL8821AE ac, 1x1 + BT4.0	3rd DP	Switch	None	1Wx1	None	None	USB / USB	None	Floor Stand	65W Adapter 88%	WES 7	1-year, Onsite	07/16
10KH0029US	US	1L	Celeron N3010	No	Intel HD 400	None	4GBx1	16GB SSD M.2	None	RTL8821AE ac, 1x1 + BT4.0	Serial	Switch	None	1Wx1	None	None	USB / USB	None	Floor Stand	65W Adapter 88%	WES 7	1-year, Onsite	07/16

Model	Region	Case 1L/2L	Processor	vPro	Graphics	Monitor Cable	Memory	Storage	External Optical / I/O Box	WLAN + Bluetooth	Optional Rear Ports	Chassis Intrusion Switch	Kensington Cable Lock	Speaker	Adapter Cage	Toolless Chassis Screw	Keyboard / Mouse	VESA Mount	Stand	Power Supply	Operating System	Warranty	Ann Date (m/y)
10G8000QUS	US	1L	Pentium N3700	No	Intel HD	None	4GBx1	500GB 7200rpm 2.5"	DVD±RW	QCA6174 ac, 2x2 + BT4.1	None	Switch	None	1Wx1	None	None	USB / USB	VESA Mount	None	65W Adapter 88%	Win10 DG Win7 Pro 64	3-year, Onsite, OID	10/15
10G8000RUS	US	1L	Pentium N3700	No	Intel HD	None	4GBx1	500GB 7200rpm 2.5"	DVD±RW	QCA6174 ac, 2x2 + BT4.1	None	Switch	None	1Wx1	None	None	USB / USB	VESA Mount	None	65W Adapter 88%	Win10 Pro 64	3-year, Onsite, OID	10/15
10G8000SUS	US	1L	Pentium N3700	No	Intel HD	None	2GBx1	500GB 7200rpm 2.5"	None	QCA9377 ac, 1x1 + BT4.1	None	Switch	None	1Wx1	None	None	USB / USB	None	None	65W Adapter 88%	Win10 Pro 64	3-year, Onsite, OID	10/15
10G8000TUS	US	1L	Pentium N3700	No	Intel HD	None	2GBx1	500GB 7200rpm 2.5"	None	QCA9377 ac, 1x1 + BT4.1	None	Switch	None	1Wx1	None	None	USB / USB	None	None	65W Adapter 88%	Win10 DG Win7 Pro 64	3-year, Onsite, OID	10/15

ThinkCentre M600 Tiny - 10GA

Product Specifications Reference (PSREF)

Model	Region	Case 1L/2L	Processor	vPro	Graphics	Monitor Cable	Memory	Storage	External Optical / I/O Box	WLAN + Bluetooth	Optional Rear Ports	Chassis Intrusion Switch	Kensington Cable Lock	Speaker	Adapter Cage	Toolless Chassis Screw	Keyboard / Mouse	VESA Mount	Stand	Power Supply	Operating System	Warranty	Ann Date (m/y)
10GA000JUS	US	1L	Celeron N3050	No	Intel HD	None	2GBx1	500GB 7200rpm 2.5"	None	None	None	Switch	None	1Wx1	None	None	USB / USB	None	None	65W Adapter 88%	Win10 DG Win7 Pro 64	3-year, Onsite, OID	10/15
10GA000KUS	US	1L	Celeron N3050	No	Intel HD	None	2GBx1	500GB 7200rpm 2.5"	DVD±RW	None	None	Switch	None	1Wx1	None	None	USB / USB	VESA Mount	None	65W Adapter 88%	Win10 Pro 64	3-year, Onsite, OID	10/15

ThinkCentre M600 Tiny - 10GC

Product Specifications Reference (PSREF)

Model	Region	Case 1L/2L	Processor	vPro	Graphics	Monitor Cable	Memory	Storage	External Optical / I/O Box	WLAN + Bluetooth	Optional Rear Ports	Chassis Intrusion Switch	Kensington Cable Lock	Speaker	Adapter Cage	Toolless Chassis Screw	Keyboard / Mouse	VESA Mount	Stand	Power Supply	Operating System	Warranty	Ann Date (m/y)
10GC0001US	US	1L	Pentium N3700	No	Intel HD	None	4GBx1	500GB 7200rpm 2.5"	DVD±RW (TIO)	QCA6174 ac, 2x2 + BT4.1	None	Switch	None	1Wx1	None	None	USB / USB	None	None	None	Win10 Pro 64	3-year, Onsite, OID	10/15
10GC0002US	US	1L	Pentium N3700	No	Intel HD	None	4GBx1	500GB 7200rpm 2.5"	None	QCA6174 ac, 2x2 + BT4.1	None	Switch	None	1Wx1	None	None	USB / USB	None	None	None	Win10 DG Win7 Pro 64	3-year, Onsite, OID	10/15

ThinkCentre M600 Tiny - 10GE

Product Specifications Reference (PSREF)

Model	Region	Case 1L/2L	Processor	vPro	Graphics	Monitor Cable	Memory	Storage	External Optical / I/O Box	WLAN + Bluetooth	Optional Rear Ports	Chassis Intrusion Switch	Kensington Cable Lock	Speaker	Adapter Cage	Toolless Chassis Screw	Keyboard / Mouse	VESA Mount	Stand	Power Supply	Operating System	Warranty	Ann Date (m/y)
10GE0001US	US	1L	Celeron N3050	No	Intel HD	None	2GBx1	500GB 7200rpm 2.5"	None	QCA9377 ac, 1x1 + BT4.1	None	Switch	None	1Wx1	None	None	USB / USB	None	None	None	Win10 DG Win7 Pro 64	3-year, Onsite, OID	10/15



ThinkCentre M700 SFF Platform Specifications

Product Specifications Reference (PSREF)

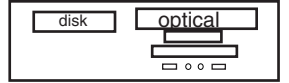
Processor	Intel® Celeron®, Intel Pentium®, or 6th Generation Intel Core™ i3 / i5 / i7 Processor	Security features	<ul style="list-style-type: none"> One lock to secure both cover and entire system to fixed object: <ul style="list-style-type: none"> -Padlock loop (in rear for opt padlock) -Security slot (in rear for optional Kensington® MicroSaver® cable) Optional cable lock to physically lock both keyboard and mouse <ul style="list-style-type: none"> Power-on password Administrator password Hard disk password Boot sequence control Boot without keyboard and mouse Individual USB port disablement Optional chassis intrusion switch 																																																												
	<table border="1"> <thead> <tr> <th>Processor</th> <th>Cores / Threads</th> <th>Frequency Base/Max(GHz)</th> <th>Cache</th> <th>Memory Types</th> <th>Integrated Graphics</th> </tr> </thead> <tbody> <tr> <td>Celeron G3900</td> <td>2 / 2</td> <td>2.8 G</td> <td>2 MB</td> <td>DDR4-2133</td> <td>HD 510</td> </tr> <tr> <td>Pentium G4400</td> <td>2 / 2</td> <td>3.3 G</td> <td>3 MB</td> <td>DDR4-2133</td> <td>HD 510</td> </tr> <tr> <td>Pentium G4500</td> <td>2 / 2</td> <td>3.5 G</td> <td>3 MB</td> <td>DDR4-2133</td> <td>HD 530</td> </tr> <tr> <td>Core i3-6100</td> <td>2 / 4</td> <td>3.7 G</td> <td>3 MB</td> <td>DDR4-2133</td> <td>HD 530</td> </tr> <tr> <td>Core i3-6300</td> <td>2 / 4</td> <td>3.8 G</td> <td>4 MB</td> <td>DDR4-2133</td> <td>HD 530</td> </tr> <tr> <td>Core i5-6400</td> <td>4 / 4</td> <td>2.7 G / 3.3 G</td> <td>6 MB</td> <td>DDR4-2133</td> <td>HD 530</td> </tr> <tr> <td>Core i5-6500</td> <td>4 / 4</td> <td>3.2 G / 3.6 G</td> <td>6 MB</td> <td>DDR4-2133</td> <td>HD 530</td> </tr> <tr> <td>Core i5-6600</td> <td>4 / 4</td> <td>3.3 G / 3.9 G</td> <td>6 MB</td> <td>DDR4-2133</td> <td>HD 530</td> </tr> <tr> <td>Core i7-6700</td> <td>4 / 8</td> <td>3.4 G / 4.0 G</td> <td>8 MB</td> <td>DDR4-2133</td> <td>HD 530</td> </tr> </tbody> </table>	Processor	Cores / Threads	Frequency Base/Max(GHz)	Cache	Memory Types	Integrated Graphics	Celeron G3900	2 / 2	2.8 G	2 MB	DDR4-2133	HD 510	Pentium G4400	2 / 2	3.3 G	3 MB	DDR4-2133	HD 510	Pentium G4500	2 / 2	3.5 G	3 MB	DDR4-2133	HD 530	Core i3-6100	2 / 4	3.7 G	3 MB	DDR4-2133	HD 530	Core i3-6300	2 / 4	3.8 G	4 MB	DDR4-2133	HD 530	Core i5-6400	4 / 4	2.7 G / 3.3 G	6 MB	DDR4-2133	HD 530	Core i5-6500	4 / 4	3.2 G / 3.6 G	6 MB	DDR4-2133	HD 530	Core i5-6600	4 / 4	3.3 G / 3.9 G	6 MB	DDR4-2133	HD 530	Core i7-6700	4 / 8	3.4 G / 4.0 G	8 MB	DDR4-2133	HD 530	Keyboard	<i>Some:</i> PS/2 Keyboard (PS/2 connector), Lenovo logo <i>Some:</i> Preferred Pro USB Keyboard (USB connector), Lenovo logo <i>Some:</i> Lenovo USB Fingerprint Keyboard (USB connector) <i>Some:</i> Ultralim Plus Wireless Keyboard (2.4GHz via USB receiver), black
Processor	Cores / Threads	Frequency Base/Max(GHz)	Cache	Memory Types	Integrated Graphics																																																										
Celeron G3900	2 / 2	2.8 G	2 MB	DDR4-2133	HD 510																																																										
Pentium G4400	2 / 2	3.3 G	3 MB	DDR4-2133	HD 510																																																										
Pentium G4500	2 / 2	3.5 G	3 MB	DDR4-2133	HD 530																																																										
Core i3-6100	2 / 4	3.7 G	3 MB	DDR4-2133	HD 530																																																										
Core i3-6300	2 / 4	3.8 G	4 MB	DDR4-2133	HD 530																																																										
Core i5-6400	4 / 4	2.7 G / 3.3 G	6 MB	DDR4-2133	HD 530																																																										
Core i5-6500	4 / 4	3.2 G / 3.6 G	6 MB	DDR4-2133	HD 530																																																										
Core i5-6600	4 / 4	3.3 G / 3.9 G	6 MB	DDR4-2133	HD 530																																																										
Core i7-6700	4 / 8	3.4 G / 4.0 G	8 MB	DDR4-2133	HD 530																																																										
		Mouse	<i>Some:</i> PS/2 Optical Wheel Mouse, black, Lenovo logo <i>Some:</i> Enhanced Optical USB Mouse, black, Lenovo logo <i>Some:</i> Ultralim Plus Wireless Mouse (2.4GHz via USB receiver), black																																																												
Memory	32GB max, UDIMM, DDR4 2133, two 288-pin DIMM sockets, dual-channel capable	Mechanical	<ul style="list-style-type: none"> SFF (9.7L), black color; metal case (WxDxH) 13.31" X 14.05" X 3.46"; 338mm X 357mm X 88mm 12.3 lb (5.6 kg) Toolless cover, disk, optical removal Toolless graphics, PCI adapter retention Optional dust filter  <p>Bay 1: N/A, 9.5mm high, external, std optical Bay 2: 3.5", 1" high, internal, std disk Bay 3: 2.5", N/A, internal, opt 2nd 2.5" disk (optional bay) Bay 4: N/A, N/A, external, opt reader Slot 1: Low Profile, PCI Express 3.0 x16 Slot 2: Low Profile, PCIe 2.0 x1 Slot 3: Low Profile, PCIe 2.0 x1</p>																																																												
Disk	<i>Some:</i> Hard disk, SATA 6.0Gb/s, 2.5"/ 3.5" wide, 5400 / 7200 rpm <i>Some:</i> Solid State Hybrid Drive (SSHD), 500GB (5400 rpm, 2.5") / 1TB or 2TB (7200 rpm, 3.5"), with 8GB NAND flash memory, SATA 6.0Gb/s <i>Some:</i> Solid State Drive (SSD) / SATA 6.0Gb/s, 2.5" Wide	Floor Stand	Optional system floor stand for vertical orientation																																																												
Optical	<i>Some:</i> DVD-ROM SATA 1.5Gb/s Drive <i>Some:</i> Super Multi-Burner DVD±RW SATA 1.5Gb/s Drive	Power supply	<i>Some:</i> 180 watts, autosensing, 85% PSU <i>Some:</i> 210 watts, autosensing, 85% PSU																																																												
Onboard SATA	Three onboard SATA 6.0Gb/s connectors	Limited warranty ³	<i>Some:</i> 1-year or 3-year, depot service / service upgrades available <i>Some:</i> 1-year or 3-year, limited onsite service / service upgrades available <i>Some:</i> 3-year, limited onsite service, OID (Onsite International Delivery) / service upgrades available <i>For Lenovo service upgrade options, please go to S-TC sheet</i>																																																												
Media reader	Optional 9-in-1 media reader	Preload	Preloaded operating system <i>Some:</i> Windows® 7 Professional 32/64 preinstalled through downgrade rights in Windows 10 Pro 64-bit <i>Some:</i> Windows 7 Professional 32/64 <i>Some:</i> Windows 10 Pro 64-bit <i>Some:</i> Windows 10 Home 64-bit																																																												
Graphics	Intel HD Graphics 510/530 in processor, uses main memory, DirectX® 12, one VGA, one DisplayPort™, supports two independent displays, works along with discrete graphics to support more displays; <i>Max resolution:</i> 4096x2304 (DP)@60Hz; 1920x1200 (VGA)@60Hz <i>Some:</i> NVIDIA® Quadro® K420 , DirectX 12, 2GB, PCIe 2.0 x16 adapter, one DVI-I, one DisplayPort, 41 watts; <i>Max resolution:</i> 3840x2160 (DisplayPort)@60Hz; 2560x1600 (DVI-I)@60Hz <i>Some:</i> NVIDIA GeForce® GT 720 , DirectX 12, 2GB, PCIe 2.0 x8 adapter, one VGA, one HDMI, 25 watts; <i>Max resolution:</i> 1920x1080 (HDMI)@60Hz; 2048x1536 (VGA)@85Hz <i>Some:</i> NVIDIA GeForce GT 720 , DirectX 12, 1GB, PCIe 2.0 x8 adapter, two DisplayPort, 25 watts; <i>Max resolution:</i> 3840x2160 (DisplayPort)@60Hz;		Preloaded applications (only some listed) <ul style="list-style-type: none"> Desktop Power Manager Lenovo Solution Center Lenovo REACHit Lenovo SHAREit Lenovo Bluetooth Lock (for models with Wi-Fi/BT card) McAfee® LiveSafe™ (30-day trial) Microsoft Office preloaded; purchase a product key to activate PowerDVD Create (DVD±RW) Lenovo ThinkVantage Tools <ul style="list-style-type: none"> - Only for Window 10 - Lenovo Companion - Cyberlink PowerDVD (DVD, DVD±RW) - Lenovo QuickOptimizer <ul style="list-style-type: none"> - Only for Window 7 - Rescue and Recovery - Password Manager - ThinkVantage System Update - Lenovo Message Center Plus - Adobe® Reader® 																																																												
DP cable	Optional DP to VGA, DP to DVI-D (single link), or DP to HDMI 1.4 dongle	Environment	ENERGY STAR® 6.0*, EPEAT™ Gold rating* (*Need 85% PSU and Windows OS); ErP Lot 3; GREENGUARD®; RoHS-compliant																																																												
Chipset	Intel H110 Chipset	Accessories	For compatible accessories, please go to TC-AQP sheet																																																												
Front ports	Two USB 3.0, two optional USB 2.0, microphone (3.5mm), headphone (3.5mm)																																																														
Rear ports	Two USB 3.0, two USB 2.0, two optional USB 2.0, serial (9-pin), optional 2nd serial (9-pin), optional parallel (25-pin), ethernet (RJ-45), one VGA, one DisplayPort, two PS/2 ports (keyboard/mouse); additional VGA, DisplayPort, DVI-I or HDMI on optional graphics on some models																																																														
Rear audio ports	Line-in (3.5mm), line-out (3.5mm), microphone-in (3.5mm)																																																														
IEEE 1394	None																																																														
Audio support	High Definition (HD) Audio, Realtek ALC662 / optional internal speaker (1.5 watt)																																																														
WLAN ¹³	<i>Some:</i> 11ac wireless, M.2 Card, Qualcomm Atheros QCA9377 (dual band), Wi-Fi + Bluetooth 4.1 combo adapter, 1x1 <i>Some:</i> 11ac wireless, M.2 Card, Qualcomm Atheros QCA6174 (dual band), Wi-Fi + Bluetooth 4.1 combo adapter, 2x2 <i>Some:</i> 11ac wireless, M.2 Card, Intel Dual Band Wireless-AC 3165, Wi-Fi + Bluetooth 4.0 combo adapter, 1x1 <i>Some:</i> 11ac wireless, M.2 Card, Intel Dual Band Wireless-AC 8260, Wi-Fi + Bluetooth 4.1 combo adapter, 2x2																																																														
Bluetooth™	<i>Some:</i> Bluetooth 4.0 or 4.1 wireless, integrated in Wi-Fi + BT combo adapter																																																														
Ethernet	Gigabit ethernet, Realtek RTL8111GN, Wake on LAN®																																																														
Modem	None																																																														
Manageability	None																																																														
Security chip	Trusted Platform Module, TCG 1.2-compliant																																																														

See footnotes for more detailed information

Model	Region	Processor	vPro	Graphics	Monitor Cable	Memory	Storage	Optical	Optional 2nd 2.5" Bay	Media Reader	WLAN + Bluetooth	Optional Front Ports	Optional Rear Ports	Chassis Intrusion Switch	Cable Lock	Dust Filter	Keyboard / Mouse	Stand	Power Supply	Operating System	Warranty	Ann Date (m/y)
10GT002DUS	US	i3-6100	No	Intel HD 530	None	4GBx1	500GB 7200rpm 3.5"	DVD±RW	Optional 2nd 2.5" Bay	None	None	None	None	None	None	None	USB / USB	Floor Stand	210W 85%	Win10 DG Win7 Pro 64	3-year, Onsite	01/16
10GT002EUS	US	i5-6400	No	Intel HD 530	None	4GBx1	500GB 7200rpm 3.5"	DVD±RW	Optional 2nd 2.5" Bay	None	None	None	None	None	None	None	USB / USB	Floor Stand	210W 85%	Win10 DG Win7 Pro 64	3-year, Onsite	01/16
10GT002FUS	US	Pentium G4400	No	Intel HD 510	None	4GBx1	500GB 7200rpm 3.5"	DVD±RW	Optional 2nd 2.5" Bay	None	None	None	None	None	None	None	USB / USB	Floor Stand	210W 85%	Win10 DG Win7 Pro 64	3-year, Onsite	01/16
10GT002GUS	US	i7-6700	No	Intel HD 530	None	8GBx1	1TB 7200rpm 3.5"	DVD±RW	Optional 2nd 2.5" Bay	None	None	None	None	None	None	None	USB / USB	Floor Stand	210W 85%	Win10 DG Win7 Pro 64	3-year, Onsite	01/16
10GT002HUS	US	i5-6400	No	Intel HD 530	None	8GBx1	128GB SSD	DVD±RW	Optional 2nd 2.5" Bay	None	None	None	None	None	None	None	USB / USB	Floor Stand	210W 85%	Win10 DG Win7 Pro 64	3-year, Onsite	01/16
10GT002JUS	US	i7-6700	No	Intel HD 530	None	8GBx1	1TB 7200rpm 3.5"	DVD±RW	None	None	None	None	None	None	None	None	USB / USB	Floor Stand	210W 85%	Win10 DG Win7 Pro 64	3-year, Onsite	01/16
10GT002KUS	US	i7-6700	No	Intel HD 530	None	8GBx1	192GB SSD	DVD±RW	None	None	None	None	None	None	None	None	USB / USB	Floor Stand	210W 85%	Win10 DG Win7 Pro 64	3-year, Onsite	01/16
10GT002LUS	US	i7-6700	No	GT 720 1GB	None	8GBx1	1TB 7200rpm 3.5"	DVD±RW	None	None	Intel 8260 ac, 2x2 + BT4.1	None	None	None	None	None	USB / USB	Floor Stand	210W 85%	Win10 DG Win7 Pro 64	3-year, Onsite	01/16
10GT002MUS	US	i7-6700	No	Intel HD 530	None	8GBx1	1TB 7200rpm 3.5"	DVD±RW	None	None	Intel 8260 ac, 2x2 + BT4.1	None	None	None	None	None	USB / USB	Floor Stand	210W 85%	Win10 DG Win7 Pro 64	3-year, Onsite	01/16
10GT002NUS	US	i5-6400	No	GT 720 2GB	None	8GBx1	1TB 7200rpm 3.5"	DVD±RW	None	None	Intel 8260 ac, 2x2 + BT4.1	None	None	None	None	None	USB / USB	Floor Stand	210W 85%	Win10 DG Win7 Pro 64	3-year, Onsite	01/16
10GT002PUS	US	i5-6400	No	Intel HD 530	None	4GBx1	500GB 7200rpm 3.5"	DVD±RW	None	None	None	None	None	None	None	None	USB / USB	Floor Stand	210W 85%	Win10 DG Win7 Pro 64	3-year, Onsite	01/16
10GT002QUS	US	i7-6700	No	Intel HD 530	None	8GBx1	120GB SSD	DVD±RW	None	None	None	None	None	None	None	None	USB / USB	Floor Stand	210W 85%	Win10 DG Win7 Pro 64	3-year, Onsite	01/16
10GT002RUS	US	i7-6700	No	Intel HD 530	None	8GBx1	500GB 7200rpm 3.5"	DVD±RW	None	None	None	None	None	None	None	None	USB / USB	Floor Stand	210W 85%	Win10 DG Win7 Pro 64	3-year, Onsite	01/16
10GT002SUS	US	i5-6400	No	Intel HD 530	None	8GBx1	1TB 7200rpm 3.5"	DVD±RW	None	None	None	None	None	None	None	None	USB / USB	Floor Stand	210W 85%	Win10 DG Win7 Pro 64	3-year, Onsite	01/16
10GT002TUS	US	i7-6700	No	Intel HD 530	None	8GBx1	256GB SSD Opal	DVD±RW	None	None	None	None	None	None	None	None	USB / USB	Floor Stand	210W 85%	Win10 DG Win7 Pro 64	3-year, Onsite	01/16
10GT002UUS	US	i5-6400	No	Intel HD 530	None	4GBx1	500GB 7200rpm 3.5"	DVD±RW	None	None	Intel 8260 ac, 2x2 + BT4.1	None	None	None	None	None	USB / USB	Floor Stand	210W 85%	Win10 DG Win7 Pro 64	3-year, Onsite	01/16
10GT002VUS	US	i5-6400	No	Intel HD 530	None	8GBx1	500GB 7200rpm 3.5"	DVD±RW	None	None	Intel 8260 ac, 2x2 + BT4.1	None	None	None	None	None	USB / USB	Floor Stand	210W 85%	Win10 DG Win7 Pro 64	3-year, Onsite	01/16
10GT002WUS	US	i5-6400	No	Intel HD 530	None	8GBx1	500GB 7200rpm 3.5"	DVD±RW	None	None	None	None	None	None	None	None	USB / USB	Floor Stand	210W 85%	Win10 DG Win7 Pro 64	3-year, Onsite	01/16
10GT0036US	US	i5-6400	No	Intel HD 530	None	8GBx1	256GB SSD Opal	DVD±RW	None	None	None	None	None	None	None	None	USB / USB	Floor Stand	210W 85%	Win10 DG Win7 Pro 64	3-year, Onsite	01/16
10GT0037US	US	i5-6400	No	Intel HD 530	None	8GBx1	192GB SSD	DVD±RW	None	None	None	None	None	None	None	None	USB / USB	Floor Stand	210W 85%	Win10 DG Win7 Pro 64	3-year, Onsite	01/16

Model	Region	Processor	vPro	Graphics	Monitor Cable	Memory	Storage	Optical	Optional 2nd 2.5" Bay	Media Reader	WLAN + Bluetooth	Optional Front Ports	Optional Rear Ports	Chassis Intrusion Switch	Cable Lock	Dust Filter	Keyboard / Mouse	Stand	Power Supply	Operating System	Warranty	Ann Date (m/y)
10GT0038US	US	i5-6400	No	Intel HD 530	None	8GBx1	120GB SSD	DVD±RW	None	None	None	None	None	None	None	None	USB / USB	Floor Stand	210W 85%	Win10 DG Win7 Pro 64	3-year, Onsite	01/16
10GT0039US	US	i3-6100	No	Intel HD 530	None	4GBx1	500GB 7200rpm 3.5"	DVD±RW	None	None	None	None	None	None	None	None	USB / USB	Floor Stand	210W 85%	Win10 DG Win7 Pro 64	3-year, Onsite	01/16
10GT003AUS	US	i3-6100	No	Intel HD 530	None	4GBx1	500GB 7200rpm 3.5"	DVD±RW	None	None	Intel 3165 ac, 1x1 + BT4.0	None	None	None	None	None	USB / USB	Floor Stand	210W 85%	Win10 DG Win7 Pro 64	3-year, Onsite	01/16
10GT003BUS	US	i3-6100	No	Intel HD 530	None	4GBx1	500GB 7200rpm 3.5"	DVD±RW	None	None	Intel 8260 ac, 2x2 + BT4.1	None	None	None	None	None	USB / USB	Floor Stand	210W 85%	Win10 DG Win7 Pro 64	3-year, Onsite	01/16
10GT003CUS	US	Pentium G4400	No	Intel HD 510	None	4GBx1	500GB 7200rpm 3.5"	DVD±RW	None	None	None	None	None	None	None	None	USB / USB	Floor Stand	210W 85%	Win10 DG Win7 Pro 64	3-year, Onsite	01/16
10GT003DUS	US	i7-6700	No	Intel HD 530	None	8GBx1	1TB 7200rpm 3.5"	DVD±RW	None	None	Intel 8260 ac, 2x2 + BT4.1	None	None	None	None	None	None / USB	Floor Stand	210W 85%	Win10 Pro 64	3-year, Onsite	01/16
10GT003EUS	US	i5-6400	No	Intel HD 530	None	4GBx1	500GB 7200rpm 3.5"	DVD±RW	None	None	Intel 8260 ac, 2x2 + BT4.1	None	None	None	None	None	None / USB	Floor Stand	210W 85%	Win10 Pro 64	3-year, Onsite	01/16
10GT003FUS	US	i3-6100	No	Intel HD 530	None	4GBx1	500GB 7200rpm 3.5"	DVD±RW	None	None	Intel 3165 ac, 1x1 + BT4.0	None	None	None	None	None	None / USB	Floor Stand	210W 85%	Win10 Pro 64	3-year, Onsite	01/16
10GT003GUS	US	Pentium G4400	No	Intel HD 510	None	4GBx1	500GB 7200rpm 3.5"	DVD±RW	None	None	Intel 3165 ac, 1x1 + BT4.0	None	None	None	None	None	None / USB	Floor Stand	210W 85%	Win10 Pro 64	3-year, Onsite	01/16
10GT004GUS	US	i5-6500	No	Intel HD 530	None	8GBx1	128GB SSD	DVD±RW	Optional 2nd 2.5" Bay	None	None	None	None	None	None	None	USB / USB	Floor Stand	210W 85%	Win10 DG Win7 Pro 64	3-year, Onsite	03/16
10GT004HUS	US	i5-6500	No	Intel HD 530	None	8GBx1	500GB 7200rpm 3.5"	DVD±RW	Optional 2nd 2.5" Bay	None	None	None	None	None	None	None	USB / USB	Floor Stand	210W 85%	Win10 DG Win7 Pro 64	3-year, Onsite	03/16
10GT004YUS	US	i5-6400	No	Intel HD 530	None	4GBx1	500GB 7200rpm 3.5"	DVD±RW	Optional 2nd 2.5" Bay	None	Intel 3165 ac, 1x1 + BT4.0	None	None	None	None	None	USB / USB	Floor Stand	210W 85%	Win10 Pro 64	3-year, Onsite	05/16
10GT0050US	US	i3-6100	No	Intel HD 530	None	4GBx1	500GB 7200rpm 3.5"	DVD±RW	Optional 2nd 2.5" Bay	None	None	None	None	None	None	None	USB / USB	Floor Stand	210W 85%	Win10 Pro 64	3-year, Onsite	05/16
10GT0051US	US	i5-6400	No	Intel HD 530	None	8GBx1	1TB 7200rpm 3.5"	DVD±RW	Optional 2nd 2.5" Bay	None	None	None	None	None	None	None	USB / USB	Floor Stand	210W 85%	Win10 Pro 64	3-year, Onsite	05/16
10GT0052US	US	i7-6700	No	Intel HD 530	None	8GBx1	1TB 7200rpm 3.5"	DVD±RW	Optional 2nd 2.5" Bay	None	None	None	None	None	None	None	USB / USB	Floor Stand	210W 85%	Win10 Pro 64	3-year, Onsite	05/16
10GT0053US	US	i7-6700	No	Intel HD 530	None	8GBx1	256GB SSD Opal	DVD±RW	Optional 2nd 2.5" Bay	None	None	None	None	None	None	None	USB / USB	Floor Stand	210W 85%	Win10 Pro 64	3-year, Onsite	05/16
10GT0054US	US	i7-6700	No	Intel HD 530	None	8GBx1	180GB SSD Opal	DVD±RW	Optional 2nd 2.5" Bay	None	None	None	None	None	None	None	USB / USB	Floor Stand	210W 85%	Win10 Pro 64	3-year, Onsite	05/16
10GT0055US	US	i7-6700	No	Intel HD 530	None	4GBx1	128GB SSD	DVD±RW	Optional 2nd 2.5" Bay	None	None	None	None	None	None	None	USB / USB	Floor Stand	210W 85%	Win10 Pro 64	3-year, Onsite	05/16
10GT0056US	US	i7-6700	No	GT 720 1GB	None	8GBx1	1TB 7200rpm 3.5"	DVD±RW	Optional 2nd 2.5" Bay	None	None	None	None	None	None	None	USB / USB	Floor Stand	210W 85%	Win10 Pro 64	3-year, Onsite	05/16
10GT005EUS	US	i7-6700	No	GT 720 1GB	None	8GBx1	1TB 7200rpm 3.5"	DVD±RW	Optional 2nd 2.5" Bay	None	None	None	None	None	None	None	USB / USB	Floor Stand	210W 85%	Win10 Pro 64	3-year, Onsite	10/16

Model	Region	Processor	vPro	Graphics	Monitor Cable	Memory	Storage	Optical	Optional 2nd 2.5" Bay	Media Reader	WLAN + Bluetooth	Optional Front Ports	Optional Rear Ports	Chassis Intrusion Switch	Cable Lock	Dust Filter	Keyboard / Mouse	Stand	Power Supply	Operating System	Warranty	Ann Date (m/y)
10GT005FUS	US	i7-6700	No	GT 720 1GB	None	8GBx1	1TB 7200rpm 3.5"	DVD±RW	Optional 2nd 2.5" Bay	None	Intel 8260 ac, 2x2 + BT4.1	None	None	None	None	None	USB / USB	Floor Stand	210W 85%	Win10 DG Win7 Pro 64	3-year, Onsite	10/16
10GT005GUS	US	i7-6700	No	GT 720 1GB	None	8GBx1	1TB 7200rpm 3.5"	DVD±RW	Optional 2nd 2.5" Bay	None	None	None	None	None	None	None	USB / USB	Floor Stand	210W 85%	Win10 DG Win7 Pro 64	3-year, Onsite	10/16
10GT005HUS	US	i7-6700	No	GT 720 1GB	None	8GBx1	1TB 7200rpm 3.5"	DVD±RW	Optional 2nd 2.5" Bay	None	Intel 8260 ac, 2x2 + BT4.1	None	None	None	None	None	USB / USB	Floor Stand	210W 85%	Win10 Pro 64	3-year, Onsite	10/16



ThinkCentre M700 Tiny Platform Specifications

Product Specifications Reference (PSREF)

Processor	Intel® Celeron®, Intel Pentium®, or 6th Generation Intel Core™ i3 / i5 / i7 Processor	Keyboard	Some: Preferred Pro USB Keyboard (USB connector), Lenovo logo Some: Lenovo Slim USB Keyboard (USB connector), black, Lenovo logo Some: Lenovo USB Fingerprint Keyboard (USB connector) Some: Ultrasmil Plus Wireless Keyboard (2.4GHz via USB receiver), black Some: Enhanced Optical USB Mouse, black, Lenovo logo Some: Ultrasmil Plus Wireless Mouse (2.4GHz via USB receiver), black																																																						
	<table border="1"> <thead> <tr> <th>Processor</th> <th>Cores / Threads</th> <th>Frequency Base/Max(GHz)</th> <th>Cache</th> <th>Memory Types</th> <th>Integrated Graphics</th> </tr> </thead> <tbody> <tr> <td>Pentium G4400T</td> <td>2 / 2</td> <td>2.9 G</td> <td>3 MB</td> <td>DDR4-2133</td> <td>HD 510</td> </tr> <tr> <td>Pentium G4500T</td> <td>2 / 2</td> <td>3.0 G</td> <td>3 MB</td> <td>DDR4-2133</td> <td>HD 530</td> </tr> <tr> <td>Core i3-6100T</td> <td>2 / 4</td> <td>3.2 G</td> <td>3 MB</td> <td>DDR4-2133</td> <td>HD 530</td> </tr> <tr> <td>Core i3-6300T</td> <td>2 / 4</td> <td>3.3 G</td> <td>4 MB</td> <td>DDR4-2133</td> <td>HD 530</td> </tr> <tr> <td>Core i5-6400T</td> <td>4 / 4</td> <td>2.2 G / 2.8 G</td> <td>6 MB</td> <td>DDR4-2133</td> <td>HD 530</td> </tr> <tr> <td>Core i5-6500T</td> <td>4 / 4</td> <td>2.5 G / 3.1 G</td> <td>6 MB</td> <td>DDR4-2133</td> <td>HD 530</td> </tr> <tr> <td>Core i5-6600T</td> <td>4 / 4</td> <td>2.7 G / 3.5 G</td> <td>6 MB</td> <td>DDR4-2133</td> <td>HD 530</td> </tr> <tr> <td>Core i7-6700T</td> <td>4 / 8</td> <td>2.8 G / 3.6 G</td> <td>8 MB</td> <td>DDR4-2133</td> <td>HD 530</td> </tr> </tbody> </table>	Processor	Cores / Threads	Frequency Base/Max(GHz)	Cache	Memory Types	Integrated Graphics	Pentium G4400T	2 / 2	2.9 G	3 MB	DDR4-2133	HD 510	Pentium G4500T	2 / 2	3.0 G	3 MB	DDR4-2133	HD 530	Core i3-6100T	2 / 4	3.2 G	3 MB	DDR4-2133	HD 530	Core i3-6300T	2 / 4	3.3 G	4 MB	DDR4-2133	HD 530	Core i5-6400T	4 / 4	2.2 G / 2.8 G	6 MB	DDR4-2133	HD 530	Core i5-6500T	4 / 4	2.5 G / 3.1 G	6 MB	DDR4-2133	HD 530	Core i5-6600T	4 / 4	2.7 G / 3.5 G	6 MB	DDR4-2133	HD 530	Core i7-6700T	4 / 8	2.8 G / 3.6 G	8 MB	DDR4-2133	HD 530	Mouse	
Processor	Cores / Threads	Frequency Base/Max(GHz)	Cache	Memory Types	Integrated Graphics																																																				
Pentium G4400T	2 / 2	2.9 G	3 MB	DDR4-2133	HD 510																																																				
Pentium G4500T	2 / 2	3.0 G	3 MB	DDR4-2133	HD 530																																																				
Core i3-6100T	2 / 4	3.2 G	3 MB	DDR4-2133	HD 530																																																				
Core i3-6300T	2 / 4	3.3 G	4 MB	DDR4-2133	HD 530																																																				
Core i5-6400T	4 / 4	2.2 G / 2.8 G	6 MB	DDR4-2133	HD 530																																																				
Core i5-6500T	4 / 4	2.5 G / 3.1 G	6 MB	DDR4-2133	HD 530																																																				
Core i5-6600T	4 / 4	2.7 G / 3.5 G	6 MB	DDR4-2133	HD 530																																																				
Core i7-6700T	4 / 8	2.8 G / 3.6 G	8 MB	DDR4-2133	HD 530																																																				
Memory	32GB max, DDR4 2133, two 260-pin SO-DIMM sockets, dual-channel capable	Mechanical	Tiny (1L), black color; metal case M700 Tiny only: 7.05" W X 7.20" D X 1.36" H 179mm W X 182.9mm D X 34.5mm H 2.9 lb (1.3 kg), weight may vary by configuration With VESA mount & ODD box: 7.42" W X 7.30" D X 2.48" H 188.4mm W X 185.38mm D X 63mm H 4.12 lb (1.87 kg), weight may vary by configuration With VESA mount & I/O box: 7.42" W X 7.30" D X 2.62" H 188.4mm W X 185.38mm D X 66.6mm H 3.53 lb (1.6 kg), weight may vary by configuration Optional VESA mount bracket kit, supports VESA 75mm and 100mm Optional system floor stand for vertical orientation																																																						
Disk	Some: SATA 6.0Gb/s, 2.5" Wide, 5400 rpm or 7200 rpm Some: 500GB (5400 rpm) Solid State Hybrid Drive (SSHD) / with 8GB MLC NAND flash memory, SATA 6.0Gb/s, 2.5" wide Some: Solid State Drive (SSD) / SATA 6.0Gb/s, 2.5" Wide Some: M.2 Solid State Drive (SSD) / SATA interface	VESA mount																																																							
Optical	Some: external ODD box with DVD-ROM, 9.5mm high, via USB Some: external ODD box with DVD±RW, 9.5mm high, via USB Some: external ODD box (for TIO) with DVD-ROM, 9.5mm high, via USB Some: external ODD box (for TIO) with DVD±RW, 9.5mm high, via USB	Floor Stand																																																							
Onboard SATA	One SATA cable (1-drop to device), one SATA 6.0Gb/s connector on planar	Power supply	65 watts AC/DC adapter, autosensing, 88% PSU (not included for TIO models) 90 watts AC/DC adapter, autosensing, 88% PSU (only for models with I/O box)																																																						
Media reader	None	Limited warranty ³	Some: 1-year or 3-year, depot service / service upgrades available Some: 1-year or 3-year, limited onsite service / service upgrades available Some: 3-year, limited onsite service, OID (Onsite International Delivery) / service upgrades available <i>For Lenovo service upgrade options, please go to S-TC sheet</i>																																																						
Graphics	Intel HD Graphics 510/530 in processor, uses main memory, DirectX® 12, two DisplayPort™, one optional HDMI, VGA, or 3rd DP, up to 3 independent displays; Max resolution: 4096x2304 (DP) @60Hz; 4096x2160 (HDMI) @24Hz; 1920x1200 (VGA) @60Hz	Preload	Some: Windows® 7 Professional 32/64 preinstalled through downgrade rights in Windows 10 Pro 64-bit Some: Windows 7 Professional 32/64 Some: Windows 10 Pro 64-bit Some: Windows 10 Home 64-bit Preloaded applications (only some listed) • Desktop Power Manager • Lenovo Solution Center • Lenovo REACHit • Lenovo SHAREit • Lenovo Bluetooth Lock (for models with Wi-Fi/BT card) • McAfee® LiveSafe™ (30-day trial) • Microsoft Office preloaded; purchase a product key to activate • PowerDVD Create (DVD±RW) • Lenovo ThinkVantage Tools • Intel Unite (vPro models only) - Only for Window 10 • Lenovo Companion • Cyberlink PowerDVD (DVD, DVD±RW) • Lenovo QuickOptimizer - Only for Window 7 • Rescue and Recovery • Password Manager • ThinkVantage System Update • Lenovo Message Center Plus • Adobe® Reader®																																																						
DP cable	Optional DP to VGA, DP to DVI-D (single link), or DP to HDMI 1.4 dongle		Some: Windows® Embedded Standard 7 (WES 7) Some: LeTOS (Lenovo Terminal Operating System, Linux-based) Preloaded applications (only some listed) - WES 7 only: • RDP Client (RDP 8.1 support) • Citrix Client • VMware Client • Internet Explorer 11 • Java • Flash • .Net Framework • Microsoft® Silverlight • Echo Agent (client for LTM, Lenovo Thin Client Manager) • Adobe Reader • UltraVNC - LeTOS only: • xFreeRDP • Citrix ICA Client • VMware View Client • Java • Mozilla Firefox																																																						
Chipset	Intel B150 Chipset																																																								
Front ports	Two USB 3.0 (one is Always On and fast charge), one microphone (stereo, 3.5mm), one headphone / microphone combo jack (stereo, 3.5mm)																																																								
Rear ports	Four USB 3.0 (optional external optical box or external I/O box occupies one or two specific USB 3.0 on some models), ethernet (RJ-45), two DisplayPort, one optional port (VGA, 3rd DP, HDMI, or serial on some models), one headphone																																																								
I/O box	Optional external I/O box, extends two USB 2.0, two USB 3.0, and one serial on rear, two USB 2.0 on front, via USB (occupy two specific USB 3.0 of M700 Tiny)																																																								
Audio support	High Definition (HD) Audio, Realtek ALC223 / optional internal speaker (1 watt)																																																								
WLAN ¹³	Some: 11ac wireless, M.2 Card, Realtek RTL8821AE (dual band), Wi-Fi + Bluetooth 4.0 combo adapter, 1x1 Some: 11ac wireless, M.2 Card, Qualcomm Atheros QCA9377 (dual band), Wi-Fi + Bluetooth 4.1 combo adapter, 1x1 Some: 11ac wireless, M.2 Card, Qualcomm Atheros QCA6174 (dual band), Wi-Fi + Bluetooth 4.1 combo adapter, 2x2 Some: 11ac wireless, M.2 Card, Intel Dual Band Wireless-AC 3165, Wi-Fi + Bluetooth 4.0 combo adapter, 1x1 Some: 11ac wireless, M.2 Card, Intel Dual Band Wireless-AC 8260, Wi-Fi + Bluetooth 4.1 combo adapter, 2x2																																																								
Bluetooth™	Some: Bluetooth 4.0 or 4.1 wireless, integrated in Wi-Fi + BT combo adapter																																																								
Ethernet	Gigabit ethernet, Intel Ethernet Connection I219-LV (Jacksonville), Wake on LAN®																																																								
Modem	None																																																								
Manageability	None																																																								
Security chip	Trusted Platform Module, TCG 1.2-compliant																																																								
Security features	<ul style="list-style-type: none"> Security slot (in rear for optional Kensington® MicroSaver® cable) Padlock loop Smart USB protection, allows keyboard/mouse only, blocks all storage devices Power-on password Administrator password Hard disk password Boot sequence control Boot without keyboard and mouse Individual USB port disablement Chassis intrusion switch 																																																								
Environment	ENERGY STAR® 6.0*, EPEAT™ Gold rating* (*for Windows models only); ErP Lot 3; GREENGUARD®; RoHS-compliant																																																								
MIL-SPEC test	MIL-STD-810G military certification (Low Pressure [Altitude], High Temperature, Low Temperature, Temperature Shock, Humidity, Sand and Dust, Vibration, Shock)																																																								
Accessories	For compatible accessories, please go to TC-AQP sheet																																																								

Model	Region	Processor	vPro	Graphics	Monitor Cable	Memory	Storage(HDD/SSD)	External Optical / I/O Box	WLAN + Bluetooth	Optional Rear Ports	Chassis Intrusion Switch	Kensington Cable Lock	Speaker	Adapter Cage	Toolless Chassis Screw	Dust Filter	Keyboard / Mouse	VESA Mount	Stand	Power Supply	Operating System	Warranty	Ann Date (m/y)
10HY0004US	US	i5-6400T	No	Intel HD 530	None	4GBx1	120GB SSD	None	Intel 8260 ac, 2x2 + BT4.1	None	Switch	None	1Wx1	None	None	None	USB / USB	None	Floor Stand	65W Adapter 88%	Win10 Pro 64	3-year, Onsite	01/16
10HY0005US	US	i5-6400T	No	Intel HD 530	None	4GBx1	180GB SSD Opal	None	Intel 8260 ac, 2x2 + BT4.1	None	Switch	None	1Wx1	None	None	None	USB / USB	None	Floor Stand	65W Adapter 88%	Win10 Pro 64	3-year, Onsite	01/16
10HY0006US	US	i5-6500T	No	Intel HD 530	None	4GBx1	120GB SSD	None	Intel 8260 ac, 2x2 + BT4.1	None	Switch	None	1Wx1	None	None	None	USB / USB	None	Floor Stand	65W Adapter 88%	Win10 Pro 64	3-year, Onsite	01/16
10HY0007US	US	i5-6500T	No	Intel HD 530	None	4GBx1	500GB 7200rpm 2.5"	None	Intel 8260 ac, 2x2 + BT4.1	None	Switch	None	1Wx1	None	None	None	USB / USB	None	Floor Stand	65W Adapter 88%	Win10 Pro 64	3-year, Onsite	01/16
10HY0008US	US	i5-6400T	No	Intel HD 530	None	4GBx1	500GB 7200rpm 2.5"	None	Intel 8260 ac, 2x2 + BT4.1	None	Switch	None	1Wx1	None	None	None	USB / USB	None	Floor Stand	65W Adapter 88%	Win10 Pro 64	3-year, Onsite	01/16
10HY0009US	US	i5-6400T	No	Intel HD 530	None	4GBx1	500GB 7200rpm 2.5"	DVD±RW	Intel 8260 ac, 2x2 + BT4.1	None	Switch	None	1Wx1	None	None	None	USB / USB	VESA Mount	None	65W Adapter 88%	Win10 Pro 64	3-year, Onsite	01/16
10HY000AUS	US	i7-6700T	No	Intel HD 530	None	8GBx1	500GB 7200rpm 2.5"	None	Intel 8260 ac, 2x2 + BT4.1	None	Switch	None	1Wx1	None	None	None	USB / USB	None	Floor Stand	65W Adapter 88%	Win10 Pro 64	3-year, Onsite	01/16
10HY000BUS	US	i7-6700T	No	Intel HD 530	None	8GBx1	120GB SSD	DVD±RW	Intel 8260 ac, 2x2 + BT4.1	None	Switch	None	1Wx1	None	None	None	USB / USB	VESA Mount	None	65W Adapter 88%	Win10 Pro 64	3-year, Onsite	01/16
10HY000CUS	US	i7-6700T	No	Intel HD 530	None	8GBx1	120GB SSD	None	Intel 8260 ac, 2x2 + BT4.1	None	Switch	None	1Wx1	None	None	None	USB / USB	None	Floor Stand	65W Adapter 88%	Win10 Pro 64	3-year, Onsite	01/16
10HY000DUS	US	i5-6400T	No	Intel HD 530	None	4GBx1	500GB 7200rpm 2.5"	DVD±RW	Intel 8260 ac, 2x2 + BT4.1	None	Switch	None	1Wx1	None	None	None	USB / USB	VESA Mount	None	65W Adapter 88%	Win10 DG Win7 Pro 64	3-year, Onsite	01/16
10HY000EUS	US	i7-6700T	No	Intel HD 530	None	8GBx1	120GB SSD	None	Intel 8260 ac, 2x2 + BT4.1	None	Switch	None	1Wx1	None	None	None	USB / USB	None	Floor Stand	65W Adapter 88%	Win10 DG Win7 Pro 64	3-year, Onsite	01/16
10HY000FUS	US	i7-6700T	No	Intel HD 530	None	8GBx1	120GB SSD	DVD±RW	Intel 8260 ac, 2x2 + BT4.1	None	Switch	None	1Wx1	None	None	None	USB / USB	VESA Mount	None	65W Adapter 88%	Win10 DG Win7 Pro 64	3-year, Onsite	01/16
10HY000GUS	US	i5-6400T	No	Intel HD 530	None	4GBx1	500GB 7200rpm 2.5"	None	Intel 8260 ac, 2x2 + BT4.1	None	Switch	None	1Wx1	None	None	None	USB / USB	None	Floor Stand	65W Adapter 88%	Win10 DG Win7 Pro 64	3-year, Onsite	01/16
10HY000HUS	US	i5-6500T	No	Intel HD 530	None	4GBx1	120GB SSD	None	Intel 8260 ac, 2x2 + BT4.1	None	Switch	None	1Wx1	None	None	None	USB / USB	None	Floor Stand	65W Adapter 88%	Win10 DG Win7 Pro 64	3-year, Onsite	01/16
10HY000JUS	US	i5-6400T	No	Intel HD 530	None	4GBx1	120GB SSD	None	Intel 8260 ac, 2x2 + BT4.1	None	Switch	None	1Wx1	None	None	None	USB / USB	None	Floor Stand	65W Adapter 88%	Win10 DG Win7 Pro 64	3-year, Onsite	01/16
10HY000KUS	US	i5-6500T	No	Intel HD 530	None	4GBx1	500GB 7200rpm 2.5"	None	Intel 8260 ac, 2x2 + BT4.1	None	Switch	None	1Wx1	None	None	None	USB / USB	None	Floor Stand	65W Adapter 88%	Win10 DG Win7 Pro 64	3-year, Onsite	01/16
10HY0013US	US	i7-6700T	No	Intel HD 530	None	8GBx1	500GB 7200rpm 2.5"	None	Intel 8260 ac, 2x2 + BT4.1	VGA	Switch	None	1Wx1	None	None	None	USB / USB	None	Floor Stand	65W Adapter 88%	Win10 Pro 64	3-year, Onsite	01/16
10HY0014US	US	i7-6700T	No	Intel HD 530	None	8GBx1	500GB 7200rpm 2.5"	None	Intel 8260 ac, 2x2 + BT4.1	HDMI	Switch	None	1Wx1	None	None	None	USB / USB	None	Floor Stand	65W Adapter 88%	Win10 Pro 64	3-year, Onsite	01/16
10HY0015US	US	i5-6400T	No	Intel HD 530	None	4GBx1	500GB 7200rpm 2.5"	None	Intel 8260 ac, 2x2 + BT4.1	HDMI	Switch	None	1Wx1	None	None	None	USB / USB	None	Floor Stand	65W Adapter 88%	Win10 Pro 64	3-year, Onsite	01/16
10HY0016US	US	i5-6400T	No	Intel HD 530	None	4GBx1	500GB 7200rpm 2.5"	None	Intel 8260 ac, 2x2 + BT4.1	3rd DP	Switch	None	1Wx1	None	None	None	USB / USB	None	Floor Stand	65W Adapter 88%	Win10 Pro 64	3-year, Onsite	01/16

Model	Region	Processor	vPro	Graphics	Monitor Cable	Memory	Storage(HDD/SSD)	External Optical / I/O Box	WLAN + Bluetooth	Optional Rear Ports	Chassis Intrusion Switch	Kensington Cable Lock	Speaker	Adapter Cage	Toolless Chassis Screw	Dust Filter	Keyboard / Mouse	VESA Mount	Stand	Power Supply	Operating System	Warranty	Ann Date (m/y)
10HY0017US	US	i5-6400T	No	Intel HD 530	None	4GBx1	500GB 7200rpm 2.5"	None	Intel 8260 ac, 2x2 + BT4.1	VGA	Switch	None	1Wx1	None	None	None	USB / USB	None	Floor Stand	65W Adapter 88%	Win10 Pro 64	3-year, Onsite	01/16
10HY0018US	US	i7-6700T	No	Intel HD 530	None	8GBx1	500GB 7200rpm 2.5"	None	Intel 8260 ac, 2x2 + BT4.1	3rd DP	Switch	None	1Wx1	None	None	None	USB / USB	None	Floor Stand	65W Adapter 88%	Win10 Pro 64	3-year, Onsite	01/16
10HY0019US	US	i5-6400T	No	Intel HD 530	None	4GBx1	500GB 7200rpm 2.5"	None	Intel 8260 ac, 2x2 + BT4.1	3rd DP	Switch	None	1Wx1	None	None	None	USB / USB	None	Floor Stand	65W Adapter 88%	Win10 DG Win7 Pro 64	3-year, Onsite	01/16
10HY001AUS	US	i7-6700T	No	Intel HD 530	None	8GBx1	500GB 7200rpm 2.5"	None	Intel 8260 ac, 2x2 + BT4.1	HDMI	Switch	None	1Wx1	None	None	None	USB / USB	None	Floor Stand	65W Adapter 88%	Win10 DG Win7 Pro 64	3-year, Onsite	01/16
10HY001BUS	US	i7-6700T	No	Intel HD 530	None	8GBx1	500GB 7200rpm 2.5"	None	Intel 8260 ac, 2x2 + BT4.1	VGA	Switch	None	1Wx1	None	None	None	USB / USB	None	Floor Stand	65W Adapter 88%	Win10 DG Win7 Pro 64	3-year, Onsite	01/16
10HY001CUS	US	i7-6700T	No	Intel HD 530	None	8GBx1	128GB SSD	None	Intel 8260 ac, 2x2 + BT4.1	HDMI	Switch	None	1Wx1	None	None	None	USB / USB	None	Floor Stand	65W Adapter 88%	Win10 DG Win7 Pro 64	3-year, Onsite	01/16
10HY001DUS	US	i5-6400T	No	Intel HD 530	None	4GBx1	500GB 7200rpm 2.5"	None	Intel 8260 ac, 2x2 + BT4.1	VGA	Switch	None	1Wx1	None	None	None	USB / USB	None	Floor Stand	65W Adapter 88%	Win10 DG Win7 Pro 64	3-year, Onsite	01/16
10HY001EUS	US	i7-6700T	No	Intel HD 530	None	8GBx1	180GB SSD Opal	None	Intel 8260 ac, 2x2 + BT4.1	None	Switch	None	1Wx1	None	None	None	USB / USB	None	Floor Stand	65W Adapter 88%	Win10 DG Win7 Pro 64	3-year, Onsite	01/16
10HY001FUS	US	i5-6400T	No	Intel HD 530	None	4GBx1	180GB SSD Opal	None	Intel 8260 ac, 2x2 + BT4.1	None	Switch	None	1Wx1	None	None	None	USB / USB	None	Floor Stand	65W Adapter 88%	Win10 DG Win7 Pro 64	3-year, Onsite	01/16
10HY001GUS	US	i7-6700T	No	Intel HD 530	None	8GBx1	500GB 7200rpm 2.5"	None	Intel 8260 ac, 2x2 + BT4.1	3rd DP	Switch	None	1Wx1	None	None	None	USB / USB	None	Floor Stand	65W Adapter 88%	Win10 DG Win7 Pro 64	3-year, Onsite	01/16
10HY001HUS	US	i7-6700T	No	Intel HD 530	None	8GBx1	128GB SSD	DVD±RW	Intel 8260 ac, 2x2 + BT4.1	HDMI	Switch	None	1Wx1	None	None	None	USB / USB	VESA Mount	None	65W Adapter 88%	Win10 DG Win7 Pro 64	3-year, Onsite	01/16
10HY001JUS	US	i5-6400T	No	Intel HD 530	None	4GBx1	500GB 7200rpm 2.5"	None	Intel 8260 ac, 2x2 + BT4.1	HDMI	Switch	None	1Wx1	None	None	None	USB / USB	None	Floor Stand	65W Adapter 88%	Win10 DG Win7 Pro 64	3-year, Onsite	01/16
10HY001KUS	US	i7-6700T	No	Intel HD 530	None	8GBx1	180GB SSD Opal	None	Intel 8260 ac, 2x2 + BT4.1	3rd DP	Switch	None	1Wx1	None	None	None	USB / USB	None	Floor Stand	65W Adapter 88%	Win10 DG Win7 Pro 64	3-year, Onsite	01/16
10HY001LUS	US	i7-6700T	No	Intel HD 530	None	8GBx1	128GB SSD	None	Intel 8260 ac, 2x2 + BT4.1	None	Switch	None	1Wx1	None	None	None	USB / USB	None	Floor Stand	65W Adapter 88%	Win10 DG Win7 Pro 64	3-year, Onsite	01/16
10HY001MUS	US	i5-6500T	No	Intel HD 530	None	4GBx1	180GB SSD Opal	None	Intel 8260 ac, 2x2 + BT4.1	None	Switch	None	1Wx1	None	None	None	USB / USB	None	Floor Stand	65W Adapter 88%	Win10 DG Win7 Pro 64	3-year, Onsite	01/16
10HY001NUS	US	i5-6400T	No	Intel HD 530	None	4GBx1	500GB 7200rpm 2.5"	DVD±RW	Intel 8260 ac, 2x2 + BT4.1	HDMI	Switch	None	1Wx1	None	None	None	USB / USB	VESA Mount	None	65W Adapter 88%	Win10 DG Win7 Pro 64	3-year, Onsite	01/16
10HY001PUS	US	i5-6400T	No	Intel HD 530	None	4GBx1	128GB SSD	None	Intel 8260 ac, 2x2 + BT4.1	None	Switch	None	1Wx1	None	None	None	USB / USB	None	Floor Stand	65W Adapter 88%	Win10 Pro 64	3-year, Onsite	01/16
10HY001QUS	US	i5-6400T	No	Intel HD 530	None	8GBx1	128GB SSD	None	Intel 8260 ac, 2x2 + BT4.1	None	Switch	None	1Wx1	None	None	None	USB / USB	None	None	65W Adapter 88%	Win10 DG Win7 Pro 64	3-year, Onsite	01/16
10HY001RUS	US	i5-6500T	No	Intel HD 530	None	8GBx1	128GB SSD	None	Intel 8260 ac, 2x2 + BT4.1	None	Switch	None	1Wx1	None	None	None	USB / USB	None	None	65W Adapter 88%	Win10 DG Win7 Pro 64	3-year, Onsite	01/16
10HY001SUS	US	i3-6100T	No	Intel HD 530	None	4GBx1	500GB 7200rpm 2.5"	None	Intel 3165 ac, 1x1 + BT4.0	None	Switch	None	1Wx1	None	None	None	USB / USB	None	Floor Stand	65W Adapter 88%	Win10 DG Win7 Pro 64	3-year, Onsite	01/16

Model	Region	Processor	vPro	Graphics	Monitor Cable	Memory	Storage(HDD/SSD)	External Optical / I/O Box	WLAN + Bluetooth	Optional Rear Ports	Chassis Intrusion Switch	Kensington Cable Lock	Speaker	Adapter Cage	Toolless Chassis Screw	Dust Filter	Keyboard / Mouse	VESA Mount	Stand	Power Supply	Operating System	Warranty	Ann Date (m/y)
10HY001TUS	US	i3-6100T	No	Intel HD 530	None	4GBx1	128GB SSD	None	Intel 3165 ac, 1x1 + BT4.0	3rd DP	Switch	None	1Wx1	None	None	None	USB / USB	None	Floor Stand	65W Adapter 88%	Win10 Pro 64	3-year, Onsite	01/16
10HY001UUS	US	i3-6100T	No	Intel HD 530	None	4GBx1	500GB 7200rpm 2.5"	DVD±RW	Intel 3165 ac, 1x1 + BT4.0	3rd DP	Switch	None	1Wx1	None	None	None	USB / USB	VESA Mount	None	65W Adapter 88%	Win10 Pro 64	3-year, Onsite	01/16
10HY001VUS	US	i3-6100T	No	Intel HD 530	None	4GBx1	128GB SSD	None	Intel 3165 ac, 1x1 + BT4.0	None	Switch	None	1Wx1	None	None	None	USB / USB	None	Floor Stand	65W Adapter 88%	Win10 DG Win7 Pro 64	3-year, Onsite	01/16
10HY001WUS	US	i3-6100T	No	Intel HD 530	None	4GBx1	128GB SSD	None	Intel 3165 ac, 1x1 + BT4.0	3rd DP	Switch	None	1Wx1	None	None	None	USB / USB	None	Floor Stand	65W Adapter 88%	Win10 DG Win7 Pro 64	3-year, Onsite	01/16
10HY001XUS	US	i3-6100T	No	Intel HD 530	None	4GBx1	500GB 7200rpm 2.5"	None	Intel 3165 ac, 1x1 + BT4.0	3rd DP	Switch	None	1Wx1	None	None	None	USB / USB	None	Floor Stand	65W Adapter 88%	Win10 DG Win7 Pro 64	3-year, Onsite	01/16
10HY001YUS	US	i3-6100T	No	Intel HD 530	None	4GBx1	500GB 7200rpm 2.5"	None	Intel 3165 ac, 1x1 + BT4.0	3rd DP	Switch	None	1Wx1	None	None	None	USB / USB	None	Floor Stand	65W Adapter 88%	Win10 Pro 64	3-year, Onsite	01/16
10HY0020US	US	i3-6100T	No	Intel HD 530	None	4GBx1	500GB 7200rpm 2.5"	None	Intel 3165 ac, 1x1 + BT4.0	VGA	Switch	None	1Wx1	None	None	None	USB / USB	None	Floor Stand	65W Adapter 88%	Win10 DG Win7 Pro 64	3-year, Onsite	01/16
10HY0021US	US	i3-6100T	No	Intel HD 530	None	8GBx1	128GB SSD	None	Intel 3165 ac, 1x1 + BT4.0	None	Switch	None	1Wx1	None	None	None	USB / USB	None	Floor Stand	65W Adapter 88%	Win10 DG Win7 Pro 64	3-year, Onsite	01/16
10HY0022US	US	i3-6100T	No	Intel HD 530	None	4GBx1	500GB 7200rpm 2.5"	DVD±RW	Intel 3165 ac, 1x1 + BT4.0	3rd DP	Switch	None	1Wx1	None	None	None	USB / USB	VESA Mount	None	65W Adapter 88%	Win10 DG Win7 Pro 64	3-year, Onsite	01/16
10HY0023US	US	i3-6100T	No	Intel HD 530	None	4GBx1	128GB SSD	DVD±RW	Intel 3165 ac, 1x1 + BT4.0	3rd DP	Switch	None	1Wx1	None	None	None	USB / USB	VESA Mount	None	65W Adapter 88%	Win10 DG Win7 Pro 64	3-year, Onsite	01/16
10HY0024US	US	i5-6500T	No	Intel HD 530	None	4GBx1	128GB SSD	None	Intel 8260 ac, 2x2 + BT4.1	None	Switch	None	1Wx1	None	None	None	USB / USB	None	Floor Stand	65W Adapter 88%	Win10 DG Win7 Pro 64	3-year, Onsite	01/16
10HY0025US	US	i7-6700T	No	Intel HD 530	None	8GBx1	128GB SSD	DVD±RW	Intel 8260 ac, 2x2 + BT4.1	None	Switch	None	1Wx1	None	None	None	USB / USB	VESA Mount	None	65W Adapter 88%	Win10 Pro 64	3-year, Onsite	01/16
10HY0026US	US	i7-6700T	No	Intel HD 530	None	8GBx1	128GB SSD	None	Intel 8260 ac, 2x2 + BT4.1	None	Switch	None	1Wx1	None	None	None	USB / USB	None	Floor Stand	65W Adapter 88%	Win10 Pro 64	3-year, Onsite	01/16
10HY0027US	US	Pentium G4400T	No	Intel HD 510	None	4GBx1	500GB 7200rpm 2.5"	None	Intel 3165 ac, 1x1 + BT4.0	None	Switch	None	1Wx1	None	None	None	USB / USB	None	Floor Stand	65W Adapter 88%	Win10 DG Win7 Pro 64	3-year, Onsite	01/16
10HY0028US	US	i5-6400T	No	Intel HD 530	None	4GBx1	256GB SSD Opal	None	Intel 8260 ac, 2x2 + BT4.1	3rd DP	Switch	None	1Wx1	None	None	None	USB / USB	None	Floor Stand	65W Adapter 88%	Win10 DG Win7 Pro 64	3-year, Onsite	01/16
10HY0029US	US	i5-6500T	No	Intel HD 530	None	4GBx1	256GB SSD Opal	None	Intel 8260 ac, 2x2 + BT4.1	3rd DP	Switch	None	1Wx1	None	None	None	USB / USB	None	Floor Stand	65W Adapter 88%	Win10 DG Win7 Pro 64	3-year, Onsite	01/16
10HY002AUS	US	i5-6500T	No	Intel HD 530	None	8GBx1	256GB SSD Opal	None	Intel 8260 ac, 2x2 + BT4.1	3rd DP	Switch	None	1Wx1	None	None	None	USB / USB	None	Floor Stand	65W Adapter 88%	Win10 DG Win7 Pro 64	3-year, Onsite	01/16
10HY002BUS	US	i5-6400T	No	Intel HD 530	None	8GBx1	256GB SSD Opal	None	Intel 8260 ac, 2x2 + BT4.1	3rd DP	Switch	None	1Wx1	None	None	None	USB / USB	None	Floor Stand	65W Adapter 88%	Win10 DG Win7 Pro 64	3-year, Onsite	01/16
10HY002CUS	US	i5-6400T	No	Intel HD 530	None	4GBx1	128GB SSD	None	Intel 8260 ac, 2x2 + BT4.1	None	Switch	None	1Wx1	None	None	None	USB / USB	None	Floor Stand	65W Adapter 88%	Win10 DG Win7 Pro 64	3-year, Onsite	01/16
10HY003HUS	US	i5-6500T	No	Intel HD 530	None	8GBx1	128GB SSD	None	Intel 8260 ac, 2x2 + BT4.1	VGA	Switch	None	1Wx1	None	None	None	USB / USB	None	Floor Stand	65W Adapter 88%	Win10 DG Win7 Pro 64	3-year, Onsite	03/16

Model	Region	Processor	vPro	Graphics	Monitor Cable	Memory	Storage(HDD/SSD)	External Optical / I/O Box	WLAN + Bluetooth	Optional Rear Ports	Chassis Intrusion Switch	Kensington Cable Lock	Speaker	Adapter Cage	Toolless Chassis Screw	Dust Filter	Keyboard / Mouse	VESA Mount	Stand	Power Supply	Operating System	Warranty	Ann Date (m/y)
10HY003JUS	US	i5-6600T	No	Intel HD 530	None	8GBx1	500GB 7200rpm 2.5"	None	Intel 8260 ac, 2x2 + BT4.1	3rd DP	Switch	None	1Wx1	None	None	None	USB / USB	None	Floor Stand	65W Adapter 88%	Win10 DG Win7 Pro 64	3-year, Onsite	03/16
10HY003KUS	US	i5-6600T	No	Intel HD 530	None	8GBx1	128GB SSD	None	Intel 8260 ac, 2x2 + BT4.1	3rd DP	Switch	None	1Wx1	None	None	None	USB / USB	None	Floor Stand	65W Adapter 88%	Win10 DG Win7 Pro 64	3-year, Onsite	03/16
10HY0057US	US	i5-6500T	No	Intel HD 530	None	8GBx1	256GB SSD Opal	None	Intel 8260 ac, 2x2 + BT4.1	3rd DP	Switch	None	1Wx1	None	None	None	USB / USB	None	Floor Stand	65W Adapter 88%	Win10 Pro 64	3-year, Onsite	07/16
10HY0058US	US	i5-6500T	No	Intel HD 530	None	8GBx1	128GB SSD	None	Intel 8260 ac, 2x2 + BT4.1	None	Switch	None	1Wx1	None	None	None	USB / USB	None	Floor Stand	65W Adapter 88%	Win10 Pro 64	3-year, Onsite	07/16
10HY0059US	US	i3-6100T	No	Intel HD 530	None	8GBx1	128GB SSD	None	Intel 3165 ac, 1x1 + BT4.0	None	Switch	None	1Wx1	None	None	None	USB / USB	None	Floor Stand	65W Adapter 88%	Win10 Pro 64	3-year, Onsite	07/16
10HY0068US	US	i3-6100T	No	Intel HD 530	None	8GBx1	500GB 7200rpm 2.5"	None	Intel 3165 ac, 1x1 + BT4.0	VGA	Switch	None	1Wx1	None	None	None	USB / USB	None	Floor Stand	65W Adapter 88%	Win10 Pro 64	3-year, Onsite	10/16
10HY0069US	US	i3-6100T	No	Intel HD 530	None	8GBx1	500GB 7200rpm 2.5"	None	Intel 3165 ac, 1x1 + BT4.0	3rd DP	Switch	None	1Wx1	None	None	None	USB / USB	None	Floor Stand	65W Adapter 88%	Win10 Pro 64	3-year, Onsite	10/16

Model	Region	Processor	vPro	Graphics	Monitor Cable	Memory	Storage(HDD/SSD)	External Optical / I/O Box	WLAN + Bluetooth	Optional Rear Ports	Chassis Intrusion Switch	Kensington Cable Lock	Speaker	Adapter Cage	Toolless Chassis Screw	Dust Filter	Keyboard / Mouse	VESA Mount	Stand	Power Supply	Operating System	Warranty	Ann Date (m/y)
10JQ0000US	US	Pentium G4400T	No	Intel HD 510	None	4GBx1	16GB SSD M.2	None	QCA6174 ac, 2x2 + BT4.1	None	Switch	None	1Wx1	None	None	None	USB / USB	None	Floor Stand	65W Adapter 88%	WES 7	3-year, Onsite	03/16
10JQ0001US	US	Pentium G4400T	No	Intel HD 510	None	4GBx1	16GB SSD M.2	None	QCA6174 ac, 2x2 + BT4.1	VGA	Switch	None	1Wx1	None	None	None	USB / USB	None	Floor Stand	65W Adapter 88%	WES 7	3-year, Onsite	03/16
10JQ0002US	US	i3-6100T	No	Intel HD 530	None	4GBx1	16GB SSD M.2	None	QCA6174 ac, 2x2 + BT4.1	3rd DP	Switch	None	1Wx1	None	None	None	USB / USB	None	Floor Stand	65W Adapter 88%	WES 7	3-year, Onsite	03/16
10JQ0003US	US	Pentium G4400T	No	Intel HD 510	None	4GBx1	16GB SSD M.2	None	QCA6174 ac, 2x2 + BT4.1	3rd DP	Switch	None	1Wx1	None	None	None	USB / USB	None	Floor Stand	65W Adapter 88%	WES 7	3-year, Onsite	03/16
10JQ0004US	US	Pentium G4400T	No	Intel HD 510	None	4GBx1	16GB SSD M.2	None	QCA6174 ac, 2x2 + BT4.1	Serial	Switch	None	1Wx1	None	None	None	USB / USB	None	Floor Stand	65W Adapter 88%	WES 7	3-year, Onsite	03/16
10JQ0005US	US	Pentium G4400T	No	Intel HD 510	None	4GBx1	16GB SSD M.2	None	QCA6174 ac, 2x2 + BT4.1	VGA	Switch	None	1Wx1	None	None	None	USB / USB	None	Floor Stand	65W Adapter 88%	LeTOS	3-year, Onsite	03/16
10JQ0006US	US	Pentium G4400T	No	Intel HD 510	None	4GBx1	16GB SSD M.2	None	QCA6174 ac, 2x2 + BT4.1	3rd DP	Switch	None	1Wx1	None	None	None	USB / USB	None	Floor Stand	65W Adapter 88%	LeTOS	3-year, Onsite	03/16
10JQ0007US	US	Pentium G4400T	No	Intel HD 510	None	4GBx1	16GB SSD M.2	None	QCA6174 ac, 2x2 + BT4.1	Serial	Switch	None	1Wx1	None	None	None	USB / USB	None	Floor Stand	65W Adapter 88%	LeTOS	3-year, Onsite	03/16
10JQ0008US	US	i3-6100T	No	Intel HD 530	None	4GBx1	16GB SSD M.2	None	QCA6174 ac, 2x2 + BT4.1	3rd DP	Switch	None	1Wx1	None	None	None	USB / USB	None	Floor Stand	65W Adapter 88%	LeTOS	3-year, Onsite	03/16
10JQ000EUS	US	Pentium G4400T	No	Intel HD 510	None	4GBx1	16GB SSD M.2	None	QCA6174 ac, 2x2 + BT4.1	None	Switch	None	1Wx1	None	None	None	USB / USB	None	Floor Stand	65W Adapter 88%	WES 7	3-year, Onsite	01/17
10JQ000FUS	US	Pentium G4400T	No	Intel HD 510	None	4GBx1	16GB SSD M.2	None	QCA6174 ac, 2x2 + BT4.1	3rd DP	Switch	None	1Wx1	None	None	None	USB / USB	None	Floor Stand	65W Adapter 88%	LeTOS	3-year, Onsite	01/17
10JQ000GUS	US	Pentium G4400T	No	Intel HD 510	None	4GBx1	16GB SSD M.2	None	QCA6174 ac, 2x2 + BT4.1	VGA	Switch	None	1Wx1	None	None	None	USB / USB	None	Floor Stand	65W Adapter 88%	WES 7	3-year, Onsite	01/17
10JQ000HUS	US	i3-6100T	No	Intel HD 530	None	4GBx1	16GB SSD M.2	None	QCA6174 ac, 2x2 + BT4.1	3rd DP	Switch	None	1Wx1	None	None	None	USB / USB	None	Floor Stand	65W Adapter 88%	WES 7	3-year, Onsite	01/17
10JQ000JUS	US	Pentium G4400T	No	Intel HD 510	None	4GBx1	16GB SSD M.2	None	QCA6174 ac, 2x2 + BT4.1	Serial	Switch	None	1Wx1	None	None	None	USB / USB	None	Floor Stand	65W Adapter 88%	LeTOS	3-year, Onsite	01/17
10JQ000KUS	US	Pentium G4400T	No	Intel HD 510	None	4GBx1	16GB SSD M.2	None	QCA6174 ac, 2x2 + BT4.1	VGA	Switch	None	1Wx1	None	None	None	USB / USB	None	Floor Stand	65W Adapter 88%	LeTOS	3-year, Onsite	01/17
10JQ000LUS	US	Pentium G4400T	No	Intel HD 510	None	4GBx1	16GB SSD M.2	None	QCA6174 ac, 2x2 + BT4.1	3rd DP	Switch	None	1Wx1	None	None	None	USB / USB	None	Floor Stand	65W Adapter 88%	WES 7	3-year, Onsite	01/17
10JQ000MUS	US	Pentium G4400T	No	Intel HD 510	None	4GBx1	16GB SSD M.2	None	QCA6174 ac, 2x2 + BT4.1	Serial	Switch	None	1Wx1	None	None	None	USB / USB	None	Floor Stand	65W Adapter 88%	WES 7	3-year, Onsite	01/17
10JQ000NUS	US	Pentium G4400T	No	Intel HD 510	None	4GBx1	16GB SSD M.2	None	QCA6174 ac, 2x2 + BT4.1	None	Switch	None	1Wx1	None	None	None	USB / USB	None	Floor Stand	65W Adapter 88%	LeTOS	3-year, Onsite	01/17



ThinkCentre M700 Tower Platform Specifications

Product Specifications Reference (PSREF)

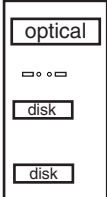
Processor	Intel® Celeron®, Intel Pentium®, or 6th Generation Intel Core™ i3 / i5 / i7 Processor	Security features	<ul style="list-style-type: none"> One lock to secure both cover and entire system to fixed object: <ul style="list-style-type: none"> -Padlock loop (in rear for opt padlock) -Security slot (in rear for optional Kensington® MicroSaver® cable) Optional cable lock to physically lock both keyboard and mouse <ul style="list-style-type: none"> Power-on password Administrator password Hard disk password Boot sequence control Boot without keyboard and mouse Individual USB port disablement Optional chassis intrusion switch 																																																												
	<table border="1"> <thead> <tr> <th>Processor</th> <th>Cores / Threads</th> <th>Frequency Base/Max(GHz)</th> <th>Cache</th> <th>Memory Types</th> <th>Integrated Graphics</th> </tr> </thead> <tbody> <tr> <td>Celeron G3900</td> <td>2 / 2</td> <td>2.8 G</td> <td>2 MB</td> <td>DDR4-2133</td> <td>HD 510</td> </tr> <tr> <td>Pentium G4400</td> <td>2 / 2</td> <td>3.3G</td> <td>3 MB</td> <td>DDR4-2133</td> <td>HD 510</td> </tr> <tr> <td>Pentium G4500</td> <td>2 / 2</td> <td>3.5G</td> <td>3 MB</td> <td>DDR4-2133</td> <td>HD 530</td> </tr> <tr> <td>Core i3-6100</td> <td>2 / 4</td> <td>3.7 G</td> <td>3 MB</td> <td>DDR4-2133</td> <td>HD 530</td> </tr> <tr> <td>Core i3-6300</td> <td>2 / 4</td> <td>3.8 G</td> <td>4 MB</td> <td>DDR4-2133</td> <td>HD 530</td> </tr> <tr> <td>Core i5-6400</td> <td>4 / 4</td> <td>2.7 G / 3.3 G</td> <td>6 MB</td> <td>DDR4-2133</td> <td>HD 530</td> </tr> <tr> <td>Core i5-6500</td> <td>4 / 4</td> <td>3.2 G / 3.6 G</td> <td>6 MB</td> <td>DDR4-2133</td> <td>HD 530</td> </tr> <tr> <td>Core i5-6600</td> <td>4 / 4</td> <td>3.3 G / 3.9 G</td> <td>6 MB</td> <td>DDR4-2133</td> <td>HD 530</td> </tr> <tr> <td>Core i7-6700</td> <td>4 / 8</td> <td>3.4 G / 4.0 G</td> <td>8 MB</td> <td>DDR4-2133</td> <td>HD 530</td> </tr> </tbody> </table>	Processor	Cores / Threads	Frequency Base/Max(GHz)	Cache	Memory Types	Integrated Graphics	Celeron G3900	2 / 2	2.8 G	2 MB	DDR4-2133	HD 510	Pentium G4400	2 / 2	3.3G	3 MB	DDR4-2133	HD 510	Pentium G4500	2 / 2	3.5G	3 MB	DDR4-2133	HD 530	Core i3-6100	2 / 4	3.7 G	3 MB	DDR4-2133	HD 530	Core i3-6300	2 / 4	3.8 G	4 MB	DDR4-2133	HD 530	Core i5-6400	4 / 4	2.7 G / 3.3 G	6 MB	DDR4-2133	HD 530	Core i5-6500	4 / 4	3.2 G / 3.6 G	6 MB	DDR4-2133	HD 530	Core i5-6600	4 / 4	3.3 G / 3.9 G	6 MB	DDR4-2133	HD 530	Core i7-6700	4 / 8	3.4 G / 4.0 G	8 MB	DDR4-2133	HD 530	Keyboard	<i>Some:</i> PS/2 Keyboard (PS/2 connector), Lenovo logo <i>Some:</i> Preferred Pro USB Keyboard (USB connector), Lenovo logo <i>Some:</i> Lenovo USB Fingerprint Keyboard (USB connector) <i>Some:</i> Ultralim Plus Wireless Keyboard (2.4GHz via USB receiver), black <i>Some:</i> PS/2 Optical Wheel Mouse, black, Lenovo logo <i>Some:</i> Enhanced Optical USB Mouse, black, Lenovo logo <i>Some:</i> Ultralim Plus Wireless Mouse (2.4GHz via USB receiver), black
Processor	Cores / Threads	Frequency Base/Max(GHz)	Cache	Memory Types	Integrated Graphics																																																										
Celeron G3900	2 / 2	2.8 G	2 MB	DDR4-2133	HD 510																																																										
Pentium G4400	2 / 2	3.3G	3 MB	DDR4-2133	HD 510																																																										
Pentium G4500	2 / 2	3.5G	3 MB	DDR4-2133	HD 530																																																										
Core i3-6100	2 / 4	3.7 G	3 MB	DDR4-2133	HD 530																																																										
Core i3-6300	2 / 4	3.8 G	4 MB	DDR4-2133	HD 530																																																										
Core i5-6400	4 / 4	2.7 G / 3.3 G	6 MB	DDR4-2133	HD 530																																																										
Core i5-6500	4 / 4	3.2 G / 3.6 G	6 MB	DDR4-2133	HD 530																																																										
Core i5-6600	4 / 4	3.3 G / 3.9 G	6 MB	DDR4-2133	HD 530																																																										
Core i7-6700	4 / 8	3.4 G / 4.0 G	8 MB	DDR4-2133	HD 530																																																										
		Mouse	<i>Some:</i> PS/2 Optical Wheel Mouse, black, Lenovo logo <i>Some:</i> Enhanced Optical USB Mouse, black, Lenovo logo <i>Some:</i> Ultralim Plus Wireless Mouse (2.4GHz via USB receiver), black																																																												
Memory	32GB max, UDIMM, DDR4 2133, two 288-pin DIMM sockets, dual-channel capable	Mechanical	<ul style="list-style-type: none"> Tower (20L), black color, metal case (WxDxH) 6.3" X 15.5" X 15.7"; 160mm X 394.5mm X 398mm 19.8 lb (9.0 kg) Optional handle Optional dust filter <p>Bay 1: 5.25", 1.6" high, access, std optical / opt front access HDD Bay 2: 3.5", 1" high, no access, std disk Bay 3: 3.5", 1" high, no access, opt disk Bay 4: N/A, N/A, external, opt reader Slot 1: half-length, full-height, PCIe 3.0 x16 Slot 2: half-length, full-height, PCIe 2.0 x1 Slot 3: half-length, full-height, PCIe 2.0 x1</p> 																																																												
Disk	<i>Some:</i> Hard disk, SATA 6.0Gb/s, 2.5"/ 3.5" wide, 5400 / 7200 rpm <i>Some:</i> Solid State Hybrid Drive (SSHD), 500GB (5400 rpm, 2.5") / 1TB or 2TB (7200 rpm, 3.5"), with 8GB NAND flash memory, SATA 6.0Gb/s <i>Some:</i> Solid State Drive (SSD) / SATA 6.0Gb/s, 2.5" Wide <i>Some:</i> Front accessible and removable HDD, 3.5", lockable via physical key <i>Some:</i> DVD-ROM SATA 1.5Gb/s Drive <i>Some:</i> Super Multi-Burner DVD±RW SATA 1.5Gb/s Drive	Power supply	<i>Some:</i> 180 watts, autosensing, 85% PSU <i>Some:</i> 250 watts, autosensing, 85% PSU																																																												
Optical	<i>Some:</i> DVD-ROM SATA 1.5Gb/s Drive <i>Some:</i> Super Multi-Burner DVD±RW SATA 1.5Gb/s Drive	Limited warranty ³	<i>Some:</i> 1-year or 3-year, depot service / service upgrades available <i>Some:</i> 1-year or 3-year, limited onsite service / service upgrades available <i>Some:</i> 3-year, limited onsite service, OID (Onsite International Delivery) / service upgrades available <i>For Lenovo service upgrade options, please go to S-TC sheet</i>																																																												
Onboard SATA Media reader	Three onboard SATA 6.0Gb/s connectors, Optional 9-in-1 media reader	Preload	Preloaded operating system <i>Some:</i> Windows® 7 Professional 32/64 preinstalled through downgrade rights in Windows 10 Pro 64-bit <i>Some:</i> Windows 7 Professional 32/64 <i>Some:</i> Windows 10 Pro 64-bit <i>Some:</i> Windows 10 Home 64-bit																																																												
Graphics	Intel HD Graphics 510/530 in processor, uses main memory, DirectX® 12, one VGA, one DisplayPort™, supports two independent displays, works along with discrete graphics to support more displays; <i>Max resolution:</i> 4096x2304 (DP) @60Hz; 1920x1200 (VGA) @60Hz <i>Some:</i> NVIDIA® Quadro® K420 , DirectX 12, 2GB, PCIe 2.0 x16 adapter, one DVI-I, one DisplayPort, 41 watts; <i>Max resolution:</i> 3840x2160 (DisplayPort) @60Hz; 2560x1600 (DVI-I) @60Hz <i>Some:</i> NVIDIA GeForce® GT 720 , DirectX 12, 2GB, PCIe 2.0 x8 adapter, one VGA, one HDMI, 25 watts; <i>Max resolution:</i> 1920x1080 (HDMI) @60Hz; 2048x1536 (VGA) @85Hz <i>Some:</i> NVIDIA GeForce GT 720 , DirectX 12, 1GB, PCIe 2.0 x8 adapter, two DisplayPort, 25 watts; <i>Max resolution:</i> 3840x2160 (DisplayPort) @60Hz;	Preloaded applications (only some listed) <ul style="list-style-type: none"> Desktop Power Manager Lenovo Solution Center Lenovo REACHit Lenovo SHAREit Lenovo Bluetooth Lock (for models with Wi-Fi/BT card) McAfee® LiveSafe™ (30-day trial) Microsoft Office preloaded; purchase a product key to activate PowerDVD Create (DVD±RW) Lenovo ThinkVantage Tools - Only for Window 10 Lenovo Companion Cyberlink PowerDVD (DVD, DVD±RW) Lenovo QuickOptimizer - Only for Window 7 Rescue and Recovery Password Manager ThinkVantage System Update Lenovo Message Center Plus Adobe® Reader® 																																																													
DP cable	Optional DP to VGA, DP to DVI-D (single link), or DP to HDMI 1.4 dongle	Environment	ENERGY STAR® 6.0*, EPEAT™ Gold rating* (*Need 85% PSU and Windows OS); ErP Lot 3; GREENGUARD ; RoHS-compliant																																																												
Chipset	Intel H110 Chipset	Accessories	For compatible accessories, please go to TC-AQP sheet																																																												
Front ports	Two USB 3.0, two optional USB 2.0, microphone (3.5mm), headphone (3.5mm)																																																														
Rear ports	Two USB 3.0, two USB 2.0, two optional USB 2.0, serial (9-pin), optional 2nd serial (9-pin), optional parallel (25-pin), ethernet (RJ-45), one VGA, one DisplayPort, two PS/2 ports (keyboard/mouse); additional VGA, DisplayPort, DVI-I or HDMI on optional graphics on some models																																																														
Rear audio ports	Line-in (3.5mm), line-out (3.5mm), microphone-in (3.5mm)																																																														
IEEE 1394	None																																																														
Audio support	High Definition (HD) Audio, Realtek ALC662 / optional internal speaker (1.5 watt)																																																														
WLAN ¹³	<i>Some:</i> 11ac wireless, M.2 Card, Qualcomm Atheros QCA9377 (dual band), Wi-Fi + Bluetooth 4.1 combo adapter, 1x1 <i>Some:</i> 11ac wireless, M.2 Card, Qualcomm Atheros QCA6174 (dual band), Wi-Fi + Bluetooth 4.1 combo adapter, 2x2 <i>Some:</i> 11ac wireless, M.2 Card, Intel Dual Band Wireless-AC 3165, Wi-Fi + Bluetooth 4.0 combo adapter, 1x1 <i>Some:</i> 11ac wireless, M.2 Card, Intel Dual Band Wireless-AC 8260, Wi-Fi + Bluetooth 4.1 combo adapter, 2x2																																																														
Bluetooth™	<i>Some:</i> Bluetooth 4.0 or 4.1 wireless, integrated in Wi-Fi + BT combo adapter																																																														
Ethernet	Gigabit ethernet, Realtek RTL8111GN, Wake on LAN®																																																														
Modem	None																																																														
Manageability	None																																																														
Security chip	Trusted Platform Module, TCG 1.2-compliant																																																														

See footnotes for more detailed information

Model	Region	Processor	vPro	Graphics	Monitor Cable	Memory	Storage	Optical	Media Reader	WLAN + Bluetooth	Optional Front Ports	Optional Rear Ports	Chassis Intrusion Switch	Cable Lock	Front Access HDD	Dust Filter	Keyboard / Mouse	Carry Handle	Power Supply	Operating System	Warranty	Ann Date (m/y)
10GR001MUS	US	i7-6700	No	Intel HD 530	None	8GBx1	1TB 7200rpm 3.5"	DVD±RW	None	None	None	None	None	None	None	None	None / USB	Carry Handle	250W 85%	Win10 DG Win7 Pro 64	3-year, Onsite	01/16
10GR001NUS	US	Pentium G4400	No	Intel HD 510	None	4GBx1	500GB 7200rpm 3.5"	DVD±RW	None	None	None	None	None	None	None	None	None / USB	Carry Handle	250W 85%	Win10 DG Win7 Pro 64	3-year, Onsite	01/16
10GR001PUS	US	i3-6100	No	Intel HD 530	None	4GBx1	500GB 7200rpm 3.5"	DVD±RW	None	None	None	None	None	None	None	None	None / USB	Carry Handle	250W 85%	Win10 DG Win7 Pro 64	3-year, Onsite	01/16
10GR001QUS	US	i5-6400	No	Intel HD 530	None	4GBx1	500GB 7200rpm 3.5"	DVD±RW	None	None	None	None	None	None	None	None	None / USB	Carry Handle	250W 85%	Win10 DG Win7 Pro 64	3-year, Onsite	01/16
10GR001RUS	US	i7-6700	No	Intel HD 530	None	8GBx1	256GB SSD Opal	DVD±RW	None	None	None	None	None	None	None	None	USB / USB	Carry Handle	250W 85%	Win10 DG Win7 Pro 64	3-year, Onsite	01/16
10GR001SUS	US	i7-6700	No	Intel HD 530	None	8GBx1	500GB 7200rpm 3.5"	DVD±RW	None	None	None	None	None	None	None	None	USB / USB	Carry Handle	250W 85%	Win10 DG Win7 Pro 64	3-year, Onsite	01/16
10GR001TUS	US	i7-6700	No	GT 720 1GB	None	8GBx1	1TB 7200rpm 3.5"	DVD±RW	None	Intel 8260 ac, 2x2 + BT4.1	None	None	None	None	None	None	USB / USB	Carry Handle	250W 85%	Win10 DG Win7 Pro 64	3-year, Onsite	01/16
10GR001UUS	US	i7-6700	No	Intel HD 530	None	8GBx1	1TB 7200rpm 3.5"	DVD±RW	None	None	None	None	None	None	None	None	USB / USB	Carry Handle	250W 85%	Win10 DG Win7 Pro 64	3-year, Onsite	01/16
10GR001VUS	US	i7-6700	No	Intel HD 530	None	8GBx1	120GB SSD	DVD±RW	None	None	None	None	None	None	None	None	USB / USB	Carry Handle	250W 85%	Win10 DG Win7 Pro 64	3-year, Onsite	01/16
10GR001WUS	US	i7-6700	No	Intel HD 530	None	8GBx1	128GB SSD	DVD±RW	None	None	None	None	None	None	None	None	USB / USB	Carry Handle	250W 85%	Win10 DG Win7 Pro 64	3-year, Onsite	01/16
10GR001XUS	US	i7-6700	No	Intel HD 530	None	8GBx1	1TB 7200rpm 3.5"	DVD±RW	None	Intel 8260 ac, 2x2 + BT4.1	None	None	None	None	None	None	USB / USB	Carry Handle	250W 85%	Win10 DG Win7 Pro 64	3-year, Onsite	01/16
10GR001YUS	US	i5-6400	No	Intel HD 530	None	8GBx1	500GB 7200rpm 3.5"	DVD±RW	None	Intel 8260 ac, 2x2 + BT4.1	None	None	None	None	None	None	USB / USB	Carry Handle	250W 85%	Win10 DG Win7 Pro 64	3-year, Onsite	01/16
10GR0020US	US	i5-6400	No	Intel HD 530	None	4GBx1	500GB 7200rpm 3.5"	DVD±RW	None	None	None	None	None	None	None	None	USB / USB	Carry Handle	250W 85%	Win10 DG Win7 Pro 64	3-year, Onsite	01/16
10GR0021US	US	i5-6400	No	Intel HD 530	None	4GBx1	500GB 7200rpm 3.5"	DVD±RW	None	Intel 8260 ac, 2x2 + BT4.1	None	None	None	None	None	None	USB / USB	Carry Handle	250W 85%	Win10 DG Win7 Pro 64	3-year, Onsite	01/16
10GR0022US	US	i5-6400	No	Intel HD 530	None	8GBx1	192GB SSD	DVD±RW	None	None	None	None	None	None	None	None	USB / USB	Carry Handle	250W 85%	Win10 DG Win7 Pro 64	3-year, Onsite	01/16
10GR0023US	US	i5-6400	No	Intel HD 530	None	8GBx1	1TB 7200rpm 3.5"	DVD±RW	None	None	None	None	None	None	None	None	USB / USB	Carry Handle	250W 85%	Win10 DG Win7 Pro 64	3-year, Onsite	01/16
10GR0024US	US	i5-6400	No	Intel HD 530	None	8GBx1	500GB 7200rpm 3.5"	DVD±RW	None	None	None	None	None	None	None	None	USB / USB	Carry Handle	250W 85%	Win10 DG Win7 Pro 64	3-year, Onsite	01/16
10GR0025US	US	i5-6400	No	GT 720 1GB	None	8GBx1	1TB 7200rpm 3.5"	DVD±RW	None	Intel 8260 ac, 2x2 + BT4.1	None	None	None	None	None	None	USB / USB	Carry Handle	250W 85%	Win10 DG Win7 Pro 64	3-year, Onsite	01/16
10GR0026US	US	i5-6400	No	Intel HD 530	None	8GBx1	120GB SSD	DVD±RW	None	None	None	None	None	None	None	None	USB / USB	Carry Handle	250W 85%	Win10 DG Win7 Pro 64	3-year, Onsite	01/16
10GR0027US	US	i5-6400	No	Intel HD 530	None	8GBx1	256GB SSD Opal	DVD±RW	None	None	None	None	None	None	None	None	USB / USB	Carry Handle	250W 85%	Win10 DG Win7 Pro 64	3-year, Onsite	01/16

Model	Region	Processor	vPro	Graphics	Monitor Cable	Memory	Storage	Optical	Media Reader	WLAN + Bluetooth	Optional Front Ports	Optional Rear Ports	Chassis Intrusion Switch	Cable Lock	Front Access HDD	Dust Filter	Keyboard / Mouse	Carry Handle	Power Supply	Operating System	Warranty	Ann Date (m/y)
10GR0028US	US	i3-6100	No	Intel HD 530	None	4GBx1	500GB 7200rpm 3.5"	DVD±RW	None	Intel 8260 ac, 2x2 + BT4.1	None	None	None	None	None	None	USB / USB	Carry Handle	250W 85%	Win10 DG Win7 Pro 64	3-year, Onsite	01/16
10GR0029US	US	i3-6100	No	Intel HD 530	None	4GBx1	500GB 7200rpm 3.5"	DVD±RW	None	None	None	None	None	None	None	None	USB / USB	Carry Handle	250W 85%	Win10 DG Win7 Pro 64	3-year, Onsite	01/16
10GR002AUS	US	i3-6100	No	Intel HD 530	None	4GBx1	500GB 7200rpm 3.5"	DVD±RW	None	Intel 3165 ac, 1x1 + BT4.0	None	None	None	None	None	None	USB / USB	Carry Handle	250W 85%	Win10 DG Win7 Pro 64	3-year, Onsite	01/16
10GR002BUS	US	Pentium G4400	No	Intel HD 510	None	4GBx1	500GB 7200rpm 3.5"	DVD±RW	None	None	None	None	None	None	None	None	USB / USB	Carry Handle	250W 85%	Win10 DG Win7 Pro 64	3-year, Onsite	01/16
10GR002CUS	US	i7-6700	No	Intel HD 530	None	8GBx1	1TB 7200rpm 3.5"	DVD±RW	None	Intel 8260 ac, 2x2 + BT4.1	None	None	None	None	None	None	USB / USB	Carry Handle	250W 85%	Win10 Pro 64	3-year, Onsite	01/16
10GR002DUS	US	Pentium G4400	No	Intel HD 510	None	4GBx1	500GB 7200rpm 3.5"	DVD±RW	None	Intel 3165 ac, 1x1 + BT4.0	None	None	None	None	None	None	USB / USB	Carry Handle	250W 85%	Win10 Pro 64	3-year, Onsite	01/16
10GR002EUS	US	i5-6400	No	Intel HD 530	None	4GBx1	500GB 7200rpm 3.5"	DVD±RW	None	Intel 8260 ac, 2x2 + BT4.1	None	None	None	None	None	None	USB / USB	Carry Handle	250W 85%	Win10 Pro 64	3-year, Onsite	01/16
10GR004FUS	US	i7-6700	No	GT 720 1GB	None	8GBx1	1TB 7200rpm 3.5"	DVD±RW	None	None	None	None	None	None	None	None	USB / USB	Carry Handle	250W 85%	Win10 Pro 64	3-year, Onsite	06/16
10GR004GUS	US	Pentium G4400	No	Intel HD 510	None	4GBx1	500GB 7200rpm 3.5"	DVD±RW	None	None	None	None	None	None	None	None	USB / USB	Carry Handle	250W 85%	Win10 Pro 64	3-year, Onsite	06/16
10GR004HUS	US	i5-6400	No	Intel HD 530	None	4GBx1	500GB 7200rpm 3.5"	DVD±RW	None	None	None	None	None	None	None	None	USB / USB	Carry Handle	250W 85%	Win10 Pro 64	3-year, Onsite	06/16
10GR004JUS	US	i3-6100	No	Intel HD 530	None	4GBx1	500GB 7200rpm 3.5"	DVD±RW	None	None	None	None	None	None	None	None	USB / USB	Carry Handle	250W 85%	Win10 Pro 64	3-year, Onsite	06/16
10GR004KUS	US	i3-6100	No	Intel HD 530	None	4GBx1	128GB SSD	DVD±RW	None	None	None	None	None	None	None	None	USB / USB	Carry Handle	250W 85%	Win10 Pro 64	3-year, Onsite	06/16
10GR004LUS	US	i5-6400	No	GT 720 1GB	None	8GBx1	1TB 7200rpm 3.5"	DVD±RW	None	None	None	None	None	None	None	None	USB / USB	Carry Handle	250W 85%	Win10 Pro 64	3-year, Onsite	06/16
10GR004MUS	US	i5-6400	No	Intel HD 530	None	8GBx1	1TB 7200rpm 3.5"	DVD±RW	None	None	None	None	None	None	None	None	USB / USB	Carry Handle	250W 85%	Win10 Pro 64	3-year, Onsite	06/16
10GR004NUS	US	i5-6400	No	Intel HD 530	None	8GBx1	256GB SSD Opal	DVD±RW	None	None	None	None	None	None	None	None	USB / USB	Carry Handle	250W 85%	Win10 Pro 64	3-year, Onsite	06/16
10GR004PUS	US	i5-6400	No	Intel HD 530	None	8GBx1	128GB SSD	DVD±RW	None	None	None	None	None	None	None	None	USB / USB	Carry Handle	250W 85%	Win10 Pro 64	3-year, Onsite	06/16
10GR004QUS	US	Pentium G4400	No	Intel HD 510	None	4GBx1	128GB SSD	DVD±RW	None	None	None	None	None	None	None	None	USB / USB	Carry Handle	250W 85%	Win10 Pro 64	3-year, Onsite	06/16
10GR004RUS	US	i7-6700	No	Intel HD 530	None	8GBx1	1TB 7200rpm 3.5"	DVD±RW	None	None	None	None	None	None	None	None	USB / USB	Carry Handle	250W 85%	Win10 Pro 64	3-year, Onsite	06/16
10GR004SUS	US	i7-6700	No	Intel HD 530	None	8GBx1	256GB SSD Opal	DVD±RW	None	None	None	None	None	None	None	None	USB / USB	Carry Handle	250W 85%	Win10 Pro 64	3-year, Onsite	06/16
10GR004TUS	US	i3-6100	No	Intel HD 530	None	8GBx1	128GB SSD	DVD±RW	None	None	None	None	None	None	None	None	USB / USB	Carry Handle	250W 85%	Win10 Pro 64	3-year, Onsite	06/16

Model	Region	Processor	vPro	Graphics	Monitor Cable	Memory	Storage	Optical	Media Reader	WLAN + Bluetooth	Optional Front Ports	Optional Rear Ports	Chassis Intrusion Switch	Cable Lock	Front Access HDD	Dust Filter	Keyboard / Mouse	Carry Handle	Power Supply	Operating System	Warranty	Ann Date (m/y)
10GR004UUS	US	i5-6400	No	Intel HD 530	None	8GBx1	1TB 7200rpm 3.5"	DVD±RW	None	Intel 3165 ac, 1x1 + BT4.0	None	None	None	None	None	None	USB / USB	Carry Handle	250W 85%	Win10 Pro 64	3-year, Onsite	06/16
10GR0056US	US	i7-6700	No	GT 720 1GB	None	8GBx1	1TB 7200rpm 3.5"	DVD±RW	None	None	None	None	None	None	None	None	USB / USB	Carry Handle	250W 85%	Win10 DG Win7 Pro 64	3-year, Onsite	10/16
10GR0057US	US	i5-6400	No	GT 720 1GB	None	8GBx1	1TB 7200rpm 3.5"	DVD±RW	None	Intel 8260 ac, 2x2 + BT4.1	None	None	None	None	None	None	USB / USB	Carry Handle	250W 85%	Win10 Pro 64	3-year, Onsite	10/16
10GR0058US	US	i7-6700	No	GT 720 1GB	None	8GBx1	1TB 7200rpm 3.5"	DVD±RW	None	Intel 8260 ac, 2x2 + BT4.1	None	None	None	None	None	None	USB / USB	Carry Handle	250W 85%	Win10 Pro 64	3-year, Onsite	10/16
10GR0059US	US	i5-6400	No	GT 720 1GB	None	8GBx1	1TB 7200rpm 3.5"	DVD±RW	None	Intel 8260 ac, 2x2 + BT4.1	None	None	None	None	None	None	USB / USB	Carry Handle	250W 85%	Win10 DG Win7 Pro 64	3-year, Onsite	10/16
10GR005AUS	US	i7-6700	No	GT 720 1GB	None	8GBx1	1TB 7200rpm 3.5"	DVD±RW	None	None	None	None	None	None	None	None	USB / USB	Carry Handle	250W 85%	Win10 Pro 64	3-year, Onsite	10/16
10GR005BUS	US	i5-6400	No	GT 720 1GB	None	8GBx1	1TB 7200rpm 3.5"	DVD±RW	None	None	None	None	None	None	None	None	USB / USB	Carry Handle	250W 85%	Win10 DG Win7 Pro 64	3-year, Onsite	10/16
10GR005CUS	US	i7-6700	No	GT 720 1GB	None	8GBx1	1TB 7200rpm 3.5"	DVD±RW	None	Intel 8260 ac, 2x2 + BT4.1	None	None	None	None	None	None	USB / USB	Carry Handle	250W 85%	Win10 DG Win7 Pro 64	3-year, Onsite	10/16
10GR005DUS	US	i5-6400	No	GT 720 1GB	None	8GBx1	1TB 7200rpm 3.5"	DVD±RW	None	None	None	None	None	None	None	None	USB / USB	Carry Handle	250W 85%	Win10 Pro 64	3-year, Onsite	10/16
10GR005EUS	US	i3-6100	No	Intel HD 530	None	8GBx1	500GB 7200rpm 3.5"	DVD±RW	None	None	None	None	None	None	None	None	USB / USB	Carry Handle	250W 85%	Win10 Pro 64	3-year, Onsite	10/16



ThinkCentre M715 Tiny Platform Specifications

Product Specifications Reference (PSREF)

Processor	AMD A6, A10, or A12 series APUs	Keyboard	<i>Some:</i> Fullsize USB Keyboard (USB connector), Lenovo logo <i>Some:</i> Lenovo New Slim USB Keyboard (USB connector), black, Lenovo logo <i>Some:</i> USB Optical Wheel Mouse, black, Lenovo logo																																										
	<table border="1"> <thead> <tr> <th>APU</th> <th>Cores</th> <th>Frequency Base/Max</th> <th>L2 Cache</th> <th>Memory Types</th> <th>Integrated Graphics</th> </tr> </thead> <tbody> <tr> <td>PRO A6-9500E</td> <td>2</td> <td>3.0 / 3.4 GHz</td> <td>1 MB</td> <td>DDR4-2400</td> <td>Radeon R5 Series</td> </tr> <tr> <td>PRO A10-9700E</td> <td>4</td> <td>3.0 / 3.5 GHz</td> <td>2 MB</td> <td>DDR4-2400</td> <td>Radeon R7 Series</td> </tr> <tr> <td>PRO A12-9800E</td> <td>4</td> <td>3.1 / 3.8 GHz</td> <td>2 MB</td> <td>DDR4-2400</td> <td>Radeon R7 Series</td> </tr> <tr> <td>PRO A6-8570E</td> <td>2</td> <td>3.0 / 3.4 GHz</td> <td>1 MB</td> <td>DDR4-2400</td> <td>Radeon R5 Series</td> </tr> <tr> <td>PRO A10-8770E</td> <td>4</td> <td>2.8 / 3.5 GHz</td> <td>2 MB</td> <td>DDR4-2400</td> <td>Radeon R7 Series</td> </tr> <tr> <td>PRO A12-8870E</td> <td>4</td> <td>2.9 / 3.8 GHz</td> <td>2 MB</td> <td>DDR4-2400</td> <td>Radeon R7 Series</td> </tr> </tbody> </table>	APU	Cores	Frequency Base/Max	L2 Cache	Memory Types	Integrated Graphics	PRO A6-9500E	2	3.0 / 3.4 GHz	1 MB	DDR4-2400	Radeon R5 Series	PRO A10-9700E	4	3.0 / 3.5 GHz	2 MB	DDR4-2400	Radeon R7 Series	PRO A12-9800E	4	3.1 / 3.8 GHz	2 MB	DDR4-2400	Radeon R7 Series	PRO A6-8570E	2	3.0 / 3.4 GHz	1 MB	DDR4-2400	Radeon R5 Series	PRO A10-8770E	4	2.8 / 3.5 GHz	2 MB	DDR4-2400	Radeon R7 Series	PRO A12-8870E	4	2.9 / 3.8 GHz	2 MB	DDR4-2400	Radeon R7 Series	Mouse	
APU	Cores	Frequency Base/Max	L2 Cache	Memory Types	Integrated Graphics																																								
PRO A6-9500E	2	3.0 / 3.4 GHz	1 MB	DDR4-2400	Radeon R5 Series																																								
PRO A10-9700E	4	3.0 / 3.5 GHz	2 MB	DDR4-2400	Radeon R7 Series																																								
PRO A12-9800E	4	3.1 / 3.8 GHz	2 MB	DDR4-2400	Radeon R7 Series																																								
PRO A6-8570E	2	3.0 / 3.4 GHz	1 MB	DDR4-2400	Radeon R5 Series																																								
PRO A10-8770E	4	2.8 / 3.5 GHz	2 MB	DDR4-2400	Radeon R7 Series																																								
PRO A12-8870E	4	2.9 / 3.8 GHz	2 MB	DDR4-2400	Radeon R7 Series																																								
Memory	32GB max, DDR4 2400, two 260-pin SO-DIMM sockets, dual-channel capable *16GB single SO-DIMM is only available via special bid models	Mechanical	Tiny (1L), black color; metal case M715 Tiny only: 7.05" W X 7.20" D X 1.36" H 179mm W X 182.9mm D X 34.5mm H 2.9 lb (1.3 kg), weight may vary by configuration With VESA mount & ODD box: 7.42" W X 7.30" D X 2.48" H 188.4mm W X 185.38mm D X 63mm H 4.12 lb (1.87 kg), weight may vary by configuration With VESA mount & I/O box: 7.42" W X 7.30" D X 2.62" H 188.4mm W X 185.38mm D X 66.6mm H 3.53 lb (1.6 kg), weight may vary by configuration Optional VESA mount bracket kit, supports VESA 75mm and 100mm Optional system floor stand for vertical orientation																																										
Disk	<i>Some:</i> SATA 6.0Gb/s, 2.5" Wide, 5400 rpm or 7200 rpm <i>Some:</i> M.2 Solid State Drive (SSD) / PCIe interface, NVMe	VESA mount																																											
Optical	<i>Some:</i> DVD-ROM, 9.0mm high, via USB external ODD box <i>Some:</i> DVD±RW, 9.0mm high, via USB external ODD box	Floor Stand																																											
Onboard SATA	One SATA cable (1-drop to device), one SATA 6.0Gb/s connector on planar	Power supply	65 watts AC/DC adapter, autosensing, 88% PSU (not included for TIO models) 90 watts AC/DC adapter, autosensing, 88% PSU (only for models with I/O box)																																										
Media reader	None	Limited warranty ³	<i>Some:</i> 1-year or 3-year, depot service / service upgrades available <i>Some:</i> 1-year or 3-year, limited onsite service / service upgrades available																																										
Graphics	AMD Radeon™ Graphics in processor, uses main memory, DirectX® 12, two DisplayPort™, one optional HDMI, VGA, or 3rd DP, up to 3 independent displays; <i>Max resolution:</i> 4096x2160 (DP) @60Hz; 4096x2160 (HDMI) @60Hz; 1920x1200 (VGA) @60Hz	Preload	Preloaded operating system <i>Some:</i> Windows 10 Pro 64-bit <i>Some:</i> Windows 10 Home 64-bit Preloaded applications (only some listed) <ul style="list-style-type: none"> • Lenovo Companion • Lenovo ID • Lenovo ThinkVantage Tools • Microsoft Office preloaded; purchase a product key to activate • Cyberlink PowerDVD (DVD, DVD±RW) • PowerDVD Create (DVD±RW) 																																										
DP cable	Optional DP to VGA, DP to DVI-D (single link), or DP to HDMI 1.4 dongle		Preloaded operating system <i>Some:</i> Windows® 7 Professional 64 preinstalled through downgrade rights in Windows 10 Pro 64-bit Preloaded applications (only some listed) <ul style="list-style-type: none"> • Lenovo Solution Center • ThinkVantage System Update • Lenovo Display Manager • Create Recovery Media • Lenovo ThinkVantage Tools • Cyberlink PowerDVD (DVD, DVD±RW) • PowerDVD Create (DVD±RW) • Microsoft Office preloaded; purchase a product key to activate • Adobe® Reader® 																																										
Chipset	AMD B300 Chipset	Environment	ENERGY STAR® 6.1*, EPEAT™ Gold rating* (*for Windows models only); ErP Lot 3; GREENGUARD®; RoHS-compliant																																										
Front ports	Two USB 3.0 (one is Always On and fast charge), one microphone (stereo, 3.5mm), one headphone / microphone combo jack (stereo, 3.5mm)	Accessories	For compatible accessories, please go to http://www.lenovoquickpick.com																																										
Rear ports	One USB 3.0 and three USB 2.0 (optional external optical box or I/O box occupies one specific USB 2.0 on some models), ethernet (RJ-45), two DisplayPort, one optional port (VGA, 3rd DP, HDMI, or serial on some models), one headphone																																												
I/O box	Optional external I/O box, extends four USB 2.0 (two on front and two on rear), one serial, and two PS/2, via USB port (occupy one specific USB 2.0 of M715q Tiny)																																												
Audio support	High Definition (HD) Audio, Realtek ALC233-CG / internal speaker (1.5 watt)																																												
WLAN ¹³	<i>Some:</i> 11ac wireless, M.2 Card, Realtek RTL8821AE (dual band), Wi-Fi + Bluetooth 4.0 combo adapter, 1x1 <i>Some:</i> 11ac wireless, M.2 Card, Realtek RTL8822BE (dual band), Wi-Fi + Bluetooth 4.1 combo adapter, 2x2 <i>Some:</i> 11ac wireless, M.2 Card, Qualcomm Atheros QCA9377 (dual band), Wi-Fi + Bluetooth 4.1 combo adapter, 1x1																																												
Bluetooth™	<i>Some:</i> Bluetooth 4.0 or 4.1 wireless, integrated in Wi-Fi + BT combo adapter																																												
Ethernet	Gigabit ethernet, Realtek RTL8111EPV, Wake on LAN®																																												
Modem	None																																												
Manageability	DASH 1.0/1.1																																												
Security chip	Discrete TPM 2.0, TCG Certified																																												
Security features	<ul style="list-style-type: none"> • Security slot (in rear for optional Kensington® MicroSaver® cable) • Padlock loop • Smart USB protection, allows keyboard/mouse only, blocks all storage devices • Power-on password • Administrator password • Hard disk password • Boot sequence control • Boot without keyboard and mouse • Individual USB port disablement • Chassis intrusion switch 																																												

See footnotes for more detailed information

(M715 Tiny-Spec) December 2016 © Lenovo

Model	Region	Processor	vPro	Graphics	Monitor Cable	Memory	Storage(HDD/SSD)	External Optical / I/O Box	WLAN + Bluetooth	Optional Rear Ports	Speaker	Adapter Cage	Toolless Chassis Screw	Dust Filter	Keyboard / Mouse	VESA Mount	Stand	Power Supply	OS	Warranty	Ann Date (m/y)
10M30001US	US	AMD PRO A6-9500E	No	AMD R5 Graphics	None	4GBx1	500GB 7200rpm 2.5"	None	RTL8821AE ac, 1x1 + BT4.0	None	1Wx1	None	None	None	USB (Slim) / USB	None	Floor Stand	65W Adapter 88%	Win10 Pro 64	3-year, Onsite	11/16
10M30002US	US	AMD PRO A10-9700E	No	AMD R7 Graphics	None	4GBx1	500GB 7200rpm 2.5"	None	RTL8821AE ac, 1x1 + BT4.0	Serial	1Wx1	None	None	None	USB / USB	None	Floor Stand	65W Adapter 88%	Win10 Pro 64	3-year, Onsite	10/16
10M30003US	US	AMD A10-9700E	No	AMD R7 Graphics	None	4GBx1	500GB 7200rpm 2.5"	None	RTL8821AE ac, 1x1 + BT4.0	VGA	1Wx1	None	None	None	USB / USB	None	Floor Stand	65W Adapter 88%	Win10 Pro 64	3-year, Onsite	10/16
10M30004US	US	AMD A10-9700E	No	AMD R7 Graphics	None	4GBx1	500GB 7200rpm 2.5"	None	RTL8821AE ac, 1x1 + BT4.0	3rd DP	1Wx1	None	None	None	USB / USB	None	Floor Stand	65W Adapter 88%	Win10 Pro 64	3-year, Onsite	10/16
10M30005US	US	AMD PRO A12-9800E	No	AMD R7 Graphics	None	4GBx1	500GB 7200rpm 2.5"	None	RTL8821AE ac, 1x1 + BT4.0	3rd DP	1Wx1	None	None	None	USB / USB	None	Floor Stand	65W Adapter 88%	Win10 Pro 64	3-year, Onsite	10/16
10M30006US	US	AMD PRO A10-9700E	No	AMD R7 Graphics	None	8GBx1	128GB SSD M.2 PCIe NVNe	None	RTL8821AE ac, 1x1 + BT4.0	3rd DP	1Wx1	None	None	None	USB / USB	None	Floor Stand	65W Adapter 88%	Win10 Pro 64	3-year, Onsite	10/16
10M30007US	US	AMD PRO A6-9500E	No	AMD R5 Graphics	None	4GBx1	500GB 7200rpm 2.5"	None	RTL8821AE ac, 1x1 + BT4.0	None	1Wx1	None	None	None	USB / USB	None	Floor Stand	65W Adapter 88%	Win10 Pro 64	3-year, Onsite	10/16
10M30008US	US	AMD PRO A10-9700E	No	AMD R7 Graphics	None	8GBx1	500GB 7200rpm 2.5"	None	RTL8821AE ac, 1x1 + BT4.0	None	1Wx1	None	None	None	USB / USB	None	Floor Stand	65W Adapter 88%	Win10 Pro 64	3-year, Onsite	10/16
10M30009US	US	AMD PRO A12-9800E	No	AMD R7 Graphics	None	8GBx1	128GB SSD M.2 PCIe NVNe	None	RTL8821AE ac, 1x1 + BT4.0	3rd DP	1Wx1	None	None	None	USB / USB	None	Floor Stand	65W Adapter 88%	Win10 Pro 64	3-year, Onsite	10/16
10M3000AUS	US	AMD PRO A12-9800E	No	AMD R7 Graphics	None	4GBx1	128GB SSD M.2 PCIe NVNe	None	RTL8821AE ac, 1x1 + BT4.0	None	1Wx1	None	None	None	USB / USB	None	Floor Stand	65W Adapter 88%	Win10 Pro 64	3-year, Onsite	10/16
10M3000BUS	US	AMD A10-9700E	No	AMD R7 Graphics	None	4GBx1	500GB 7200rpm 2.5"	None	RTL8821AE ac, 1x1 + BT4.0	None	1Wx1	None	None	None	USB / USB	None	Floor Stand	65W Adapter 88%	Win10 Pro 64	3-year, Onsite	10/16
10M3000CUS	US	AMD PRO A10-9700E	No	AMD R7 Graphics	None	4GBx1	128GB SSD M.2 PCIe NVNe	None	RTL8821AE ac, 1x1 + BT4.0	3rd DP	1Wx1	None	None	None	USB / USB	None	Floor Stand	65W Adapter 88%	Win10 Pro 64	3-year, Onsite	10/16
10M3000DUS	US	AMD PRO A10-9700E	No	AMD R7 Graphics	None	4GBx1	500GB 7200rpm 2.5"	DVD±RW	RTL8821AE ac, 1x1 + BT4.0	HDMI	1Wx1	None	None	None	USB / USB	VESA Mount	None	65W Adapter 88%	Win10 Pro 64	3-year, Onsite	10/16
10M3000NUS	US	AMD PRO A12-8870E	No	AMD R7 Graphics	None	8GBx2	512GB SSD M.2 PCIe NVNe	None	RTL8821AE ac, 1x1 + BT4.0	None	1Wx1	None	None	None	USB / USB	None	Floor Stand	65W Adapter 88%	Win10 DG Win7 Pro 64	3-year, Onsite	01/17
10M3000PUS	US	AMD PRO A12-9800E	No	AMD R7 Graphics	None	8GBx2	512GB SSD M.2 PCIe NVNe	None	RTL8821AE ac, 1x1 + BT4.0	None	1Wx1	None	None	None	USB / USB	None	Floor Stand	65W Adapter 88%	Win10 Pro 64	3-year, Onsite	01/17
10M3000QUS	US	AMD PRO A10-8770E	No	AMD R7 Graphics	None	8GBx1	256GB SSD M.2 PCIe NVNe	None	RTL8821AE ac, 1x1 + BT4.0	None	1Wx1	None	None	None	USB / USB	None	Floor Stand	65W Adapter 88%	Win10 DG Win7 Pro 64	3-year, Onsite	01/17
10M3000RUS	US	AMD PRO A10-8770E	No	AMD R7 Graphics	None	8GBx1	500GB 7200rpm 2.5"	None	RTL8821AE ac, 1x1 + BT4.0	None	1Wx1	None	None	None	USB / USB	None	Floor Stand	65W Adapter 88%	Win10 DG Win7 Pro 64	3-year, Onsite	01/17
10M3000SUS	US	AMD PRO A10-8770E	No	AMD R7 Graphics	None	8GBx1	500GB 7200rpm 2.5"	DVD±RW	RTL8821AE ac, 1x1 + BT4.0	3rd DP	1Wx1	None	None	None	USB / USB	VESA Mount	None	65W Adapter 88%	Win10 DG Win7 Pro 64	3-year, Onsite	01/17
10M3000TUS	US	AMD PRO A10-8770E	No	AMD R7 Graphics	None	4GBx1	500GB 7200rpm 2.5"	None	RTL8821AE ac, 1x1 + BT4.0	None	1Wx1	None	None	None	USB / USB	None	Floor Stand	65W Adapter 88%	Win10 DG Win7 Pro 64	3-year, Onsite	01/17

Model	Region	Processor	vPro	Graphics	Monitor Cable	Memory	Storage(HDD/SSD)	External Optical / I/O Box	WLAN + Bluetooth	Optional Rear Ports	Speaker	Adapter Cage	Toolless Chassis Screw	Dust Filter	Keyboard / Mouse	VESA Mount	Stand	Power Supply	OS	Warranty	Ann Date (m/y)
10M3000UUS	US	AMD PRO A10-8770E	No	AMD R7 Graphics	None	8GBx1	128GB SSD M.2 PCIe NVMe	None	RTL8821AE ac, 1x1 + BT4.0	3rd DP	1Wx1	None	None	None	USB / USB	None	Floor Stand	65W Adapter 88%	Win10 DG Win7 Pro 64	3-year, Onsite	01/17
10M3000VUS	US	AMD PRO A10-8770E	No	AMD R7 Graphics	None	8GBx1	256GB SSD M.2 PCIe NVMe	None	RTL8821AE ac, 1x1 + BT4.0	3rd DP	1Wx1	None	None	None	USB / USB	None	Floor Stand	65W Adapter 88%	Win10 DG Win7 Pro 64	3-year, Onsite	01/17
10M3000WUS	US	AMD PRO A10-9700E	No	AMD R7 Graphics	None	8GBx1	256GB SSD M.2 PCIe NVMe	None	RTL8821AE ac, 1x1 + BT4.0	None	1Wx1	None	None	None	USB / USB	None	Floor Stand	65W Adapter 88%	Win10 Pro 64	3-year, Onsite	01/17
10M3000XUS	US	AMD PRO A12-8870E	No	AMD R7 Graphics	None	8GBx1	256GB SSD M.2 PCIe NVMe	None	RTL8821AE ac, 1x1 + BT4.0	3rd DP	1Wx1	None	None	None	USB / USB	None	Floor Stand	65W Adapter 88%	Win10 DG Win7 Pro 64	3-year, Onsite	01/17
10M3000YUS	US	AMD PRO A10-8770E	No	AMD R7 Graphics	None	8GBx1	500GB 7200rpm 2.5"	None	RTL8821AE ac, 1x1 + BT4.0	3rd DP	1Wx1	None	None	None	USB / USB	None	Floor Stand	65W Adapter 88%	Win10 DG Win7 Pro 64	3-year, Onsite	01/17
10M30010US	US	AMD PRO A10-9700E	No	AMD R7 Graphics	None	4GBx1	500GB 7200rpm 2.5"	None	RTL8821AE ac, 1x1 + BT4.0	None	1Wx1	None	None	None	USB / USB	None	Floor Stand	65W Adapter 88%	Win10 Pro 64	3-year, Onsite	01/17
10M30011US	US	AMD PRO A12-8870E	No	AMD R7 Graphics	None	8GBx1	128GB SSD M.2 PCIe NVMe	None	RTL8821AE ac, 1x1 + BT4.0	None	1Wx1	None	None	None	USB / USB	None	Floor Stand	65W Adapter 88%	Win10 DG Win7 Pro 64	3-year, Onsite	01/17



ThinkCentre M79 SFF Platform Specifications

Product Specifications Reference (PSREF)

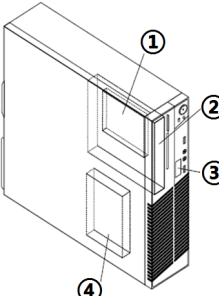
Processor	AMD A4, A6, A8, or A10 series APUs	<ul style="list-style-type: none"> • Cable lock to physically lock both keyboard and mouse (optional) • Power-on password • Boot without keyboard and mouse • Individual USB port disablement • Optional Chassis intrusion switch 																																																																								
	<table border="1"> <thead> <tr> <th>APU</th> <th>Cores</th> <th>Frequency (Max/Base)</th> <th>L2 Cache</th> <th>Memory Types</th> <th>Integrated Graphics</th> </tr> </thead> <tbody> <tr> <td>A4-6300B</td> <td>2</td> <td>3.9 / 3.7</td> <td>1MB</td> <td>DDR3-1600</td> <td>HD 8370D</td> </tr> <tr> <td>A4 PRO-7300B</td> <td>2</td> <td>4.0 / 3.8</td> <td>1MB</td> <td>DDR3-1600</td> <td>HD 8470D</td> </tr> <tr> <td>PRO A4-8350B</td> <td>2</td> <td>3.9 / 3.5</td> <td>1MB</td> <td>DDR3-1866</td> <td>Radeon R5 Series</td> </tr> <tr> <td>A6-6400B</td> <td>2</td> <td>4.1 / 3.9</td> <td>1MB</td> <td>DDR3-1866</td> <td>HD 8470D</td> </tr> <tr> <td>A6 PRO-7400B</td> <td>2</td> <td>3.9 / 3.5</td> <td>1MB</td> <td>DDR3-1866</td> <td>Radeon R5 Series</td> </tr> <tr> <td>PRO A6-8550B</td> <td>2</td> <td>4.0 / 3.7</td> <td>1MB</td> <td>DDR3-2133</td> <td>Radeon R5 Series</td> </tr> <tr> <td>A8-6500B</td> <td>4</td> <td>4.1 / 3.5</td> <td>4MB</td> <td>DDR3-1866</td> <td>HD 8570D</td> </tr> <tr> <td>A8 PRO-7600B</td> <td>4</td> <td>3.8 / 3.1</td> <td>4MB</td> <td>DDR3-2133</td> <td>Radeon R7 Series</td> </tr> <tr> <td>PRO A8-8650B</td> <td>4</td> <td>3.9 / 3.2</td> <td>4MB</td> <td>DDR3-2133</td> <td>Radeon R7 Series</td> </tr> <tr> <td>A10 PRO-7800B</td> <td>4</td> <td>3.9 / 3.5</td> <td>4MB</td> <td>DDR3-2133</td> <td>Radeon R7 Series</td> </tr> <tr> <td>PRO A10-8750B</td> <td>4</td> <td>4.0 / 3.6</td> <td>4MB</td> <td>DDR3-2133</td> <td>Radeon R7 Series</td> </tr> </tbody> </table>	APU	Cores	Frequency (Max/Base)	L2 Cache	Memory Types	Integrated Graphics	A4-6300B	2	3.9 / 3.7	1MB	DDR3-1600	HD 8370D	A4 PRO-7300B	2	4.0 / 3.8	1MB	DDR3-1600	HD 8470D	PRO A4-8350B	2	3.9 / 3.5	1MB	DDR3-1866	Radeon R5 Series	A6-6400B	2	4.1 / 3.9	1MB	DDR3-1866	HD 8470D	A6 PRO-7400B	2	3.9 / 3.5	1MB	DDR3-1866	Radeon R5 Series	PRO A6-8550B	2	4.0 / 3.7	1MB	DDR3-2133	Radeon R5 Series	A8-6500B	4	4.1 / 3.5	4MB	DDR3-1866	HD 8570D	A8 PRO-7600B	4	3.8 / 3.1	4MB	DDR3-2133	Radeon R7 Series	PRO A8-8650B	4	3.9 / 3.2	4MB	DDR3-2133	Radeon R7 Series	A10 PRO-7800B	4	3.9 / 3.5	4MB	DDR3-2133	Radeon R7 Series	PRO A10-8750B	4	4.0 / 3.6	4MB	DDR3-2133	Radeon R7 Series	<p>Keyboard</p> <p>Some: Preferred Pro USB Keyboard (USB connector), Lenovo logo Some: Lenovo USB Fingerprint Keyboard (USB connector) Some: Ultralim Plus Wireless Keyboard (2.4GHz via USB receiver), black</p> <p>Mouse</p> <p>Some: Enhanced Optical USB Mouse, black, Lenovo logo Some: Ultralim Plus Wireless Mouse (2.4GHz via USB receiver), black</p> <p>Mechanical</p> <ul style="list-style-type: none"> • Business black color; metal case, 11L • 13.2" W X 15.0" D X 3.9" H • 335mm W X 382mm D X 101mm H • 14.6 lb (6.6 kg) in maximum configuration Bay 1: N/A, N/A, internal, opt SSD Bay 2: 5.25", 1.6" high, external, std optical Bay 3: N/A, N/A, external, opt reader Bay 4: 3.5", 1" high, internal, std disk <p>*bay only available on models with HDD/SSD/reader installed</p> <p>Slot 1: Low Profile, PCI Express 3.0 x16 (40w max) Slot 2: Low Profile, PCIe 2.0 x1 Slot 2: Low Profile, PCIe 2.0 x1 Slot 4: Low Profile, 32-bit PCI 2.3</p> <p>Floor Stand</p> <p>Optional system floor stand for vertical orientation</p>  <p>Power supply</p> <p>Some: 180 watts, autosensing, 100-240V (50-60Hz) Some: 240 watts, autosensing, 100-240V (50-60Hz) Some: 240 watts, autosensing, 85% PSU, 100-240V (50-60Hz)</p> <p>Limited warranty³</p> <p>Some: 3-years, limited onsite service / service upgrades available Some: 3-years, limited onsite service, OID (Onsite International Delivery) / service upgrades available For Lenovo service upgrade options, please go to S-TC sheet</p> <p>Preload</p> <p>Some: Windows[®] 7 Professional 32/64 preinstalled through downgrade rights in Windows 8.1 Pro 64-bit Some: Windows 7 Professional 32 Some: Windows 7 Professional 64</p> <p>Ready to install applications (only some listed)</p> <ul style="list-style-type: none"> • Rescue and Recovery™ • Password Manager <p>Preloaded applications (only some listed)</p> <ul style="list-style-type: none"> • ThinkVantage[®] Product Recovery • ThinkVantage System Update • ThinkVantage Communication Utility • ThinkVantage Device Experience • Desktop Power Manager • View Management Utility • Lenovo Solution Center • Lenovo Message Center Plus • Norton™ Internet Security (30 days of virus definitions) • Adobe[®] Reader[®] • Skype™ • Microsoft Office preloaded; purchase a product key to activate • Cyberlink Power2Go (DVD±RW) • Cyberlink PowerProducer (DVD±RW) • Evernote[®] • Nitro Pro <p>Some: Windows 8.1 64-bit Some: Windows 8.1 Pro 64-bit Some: Windows 10 Pro 64-bit</p> <p>Preloaded applications (only some listed)</p> <ul style="list-style-type: none"> • Desktop Power Manager • Lenovo Solution Center • Lenovo Companion • Lenovo SHAREit • Lenovo REACHit • McAfee[®] LiveSafe™(30-day trial) • Microsoft Office preloaded; purchase a product key to activate • Cyberlink PowerDVD (DVD±RW, DVD) • PowerDVD Create (DVD±RW) • PC Device Stage
APU	Cores	Frequency (Max/Base)	L2 Cache	Memory Types	Integrated Graphics																																																																					
A4-6300B	2	3.9 / 3.7	1MB	DDR3-1600	HD 8370D																																																																					
A4 PRO-7300B	2	4.0 / 3.8	1MB	DDR3-1600	HD 8470D																																																																					
PRO A4-8350B	2	3.9 / 3.5	1MB	DDR3-1866	Radeon R5 Series																																																																					
A6-6400B	2	4.1 / 3.9	1MB	DDR3-1866	HD 8470D																																																																					
A6 PRO-7400B	2	3.9 / 3.5	1MB	DDR3-1866	Radeon R5 Series																																																																					
PRO A6-8550B	2	4.0 / 3.7	1MB	DDR3-2133	Radeon R5 Series																																																																					
A8-6500B	4	4.1 / 3.5	4MB	DDR3-1866	HD 8570D																																																																					
A8 PRO-7600B	4	3.8 / 3.1	4MB	DDR3-2133	Radeon R7 Series																																																																					
PRO A8-8650B	4	3.9 / 3.2	4MB	DDR3-2133	Radeon R7 Series																																																																					
A10 PRO-7800B	4	3.9 / 3.5	4MB	DDR3-2133	Radeon R7 Series																																																																					
PRO A10-8750B	4	4.0 / 3.6	4MB	DDR3-2133	Radeon R7 Series																																																																					
Memory	32GB max, UDIMM, PC3-12800 1600MHz DDR3, four 240-pin DIMM sockets																																																																									
Disk	Some: SATA 6.0Gb/s, 3.5" Wide, 7200 rpm Some: hybrid hard disk / with 8GB MLC NAND flash memory, SATA 6.0Gb/s, 5400 rpm 2.5" wide or 7200 rpm 3.5" wide																																																																									
Optical	Some: Solid State Drive (SSD) / SATA 6.0Gb/s, 2.5" Wide Some: DVD-ROM SATA 1.5Gb/s Drive Some: Super Multi-Burner DVD±RW SATA 1.5Gb/s Drive																																																																									
Onboard SATA	SATA 6.0Gb/s controller, three connectors on planar, RAID 0/1 support (only applicable on dual SSD models)																																																																									
Media reader	Optional 7-in-1 single slot media card reader																																																																									
Graphics	AMD Radeon™ Graphics in processor, uses main memory, one VGA, one DisplayPort™, one optional DP, supports up to three independent displays, works along with optional discrete graphics to support up to five independent displays; <i>Maximum resolution: 1920x1200 (VGA)@60Hz; 2560x2048 (DisplayPort)@60Hz</i> Some: AMD Radeon HD 8570 , DirectX 11, 3D Hardware Acceleration, 2GB, PCI Express 3.0 x16 adapter (8x elec), one VGA, one HDMI, 40W; <i>Max resolution: 4096x2160 (HDMI)@24Hz; 2048x1536 (VGA)@85Hz</i> Some: NVIDIA[®] GeForce[®] GT 620 , DirectX 11, 3D Hardware Acceleration, 1GB, PCI Express 2.0 x16 adapter, one VGA, one DisplayPort, 30 watts; <i>Max resolution: 2560x1600 (DisplayPort)@60Hz; 2048x1536 (VGA)@85Hz</i> Some: AMD Radeon™ HD 7450 , DirectX 11, 3D Hardware Acceleration, 1GB, PCI Express 2.0 x16 adapter, one DVI-I (includes DVI-to-VGA dongle), one DisplayPort, 25 watts; <i>Max resolution: 2560x1600 (DisplayPort, DVI-I)@60Hz</i>																																																																									
DP cable	Optional DisplayPort to DVI-D monitor cable																																																																									
Chipset	AMD A78 FCH																																																																									
Front ports	Two USB 2.0, microphone (stereo, 3.5mm), headphone (stereo, 3.5mm)																																																																									
Rear ports	Up to six USB ports (2x USB 3.0 + 2x USB 2.0 + 2x optional USB 2.0), serial (9-pin), optional 2nd serial (9-pin), optional parallel (25-pin), ethernet (RJ-45), VGA, DisplayPort (1x standard + 1x optional), two PS/2 ports																																																																									
Rear audio ports	Line-in (stereo, 3.5mm), line-out (stereo, 3.5mm), microphone (stereo, 3.5mm)																																																																									
IEEE 1394	Optional FireWire PCIe adapter, 1394a-2000, 400Mbps, two 6-pin ports on rear																																																																									
Audio support	High Definition (HD) Audio, Realtek ALC662 / internal speaker (1watt)																																																																									
WLAN ¹³	Some: 11b/g/n wireless, Realtek RTL8723BE, Wi-Fi + BT 4.0 combo, 1x1 Some: 11b/g/n wireless, Realtek RTL8192EE, Wi-Fi + BT 4.0 combo, 2x2 Some: 11ac/b/g/n wireless, Broadcom BCM4352, 2.4/5GHz, Wi-Fi + BT 4.0, 2x2																																																																									
Bluetooth™	Some: Bluetooth 4.0 wireless, integrated in Wi-Fi + Bluetooth combo adapter																																																																									
Ethernet	One gigabit ethernet port, Realtek 8111EPV, Wake on LAN [®]																																																																									
Modem	None																																																																									
Manageability	Enhanced Manageability with DASH 1.1																																																																									
Security chip	Trusted Platform Module, TCG 1.2-compliant																																																																									
Security features	<ul style="list-style-type: none"> • Padlock loop (in rear for opt padlock) • Security slot (in rear for optional Kensington[®] MicroSaver[®] cable) • Administrator password • Hard disk password • Boot sequence control 																																																																									
Environment	ENERGY STAR [®] 6.0 (Need 85% PSU and Windows OS); EPEAT™ Gold rating (Need 85% PSU and Windows OS); GREENGUARD [®] ; RoHS-compliant; Cisco EnergyWise compatible; ErP Lot 3																																																																									
Accessories	For compatible accessories, please go to TC-AQP sheet																																																																									

See footnotes for more detailed information

(ALSK1-SFF) September 2015 © Lenovo

Model	Region	Processor	vPro	Graphics	Monitor Cable	Memory	Storage	Optical	Media Reader	WLAN + Bluetooth	Optional Rear Ports	Chassis Intrusion Switch	Cable Lock	Keyboard / Mouse	Stand	Power Supply	Operating System	Warranty	Ann Date (m/y)
10CV0000US	US	A6-6400B	No	AMD HD 8470D	None	4GBx1	500GB 7200rpm 3.5"	DVD±RW	None	None	None	None	None	USB / USB	None	180W	Win8.1 DG Win7 Pro 64	3-year, Onsite	07/14
10CV0001US	US	AMD A8-6500B	No	AMD HD 8570D	None	4GBx1	500GB 7200rpm 3.5"	DVD±RW	None	None	None	None	None	USB / USB	None	180W	Win8.1 DG Win7 Pro 64	3-year, Onsite	07/14
10CV0002US	US	A8 PRO-7600B	No	AMD R7 Graphics	None	4GBx1	500GB 7200rpm 3.5"	DVD±RW	None	None	None	None	None	USB / USB	None	240W	Win8.1 DG Win7 Pro 64	3-year, Onsite	07/14
10CV0003US	US	A4-6300B	No	AMD HD 8370D	None	4GBx1	500GB 7200rpm 3.5"	DVD	None	None	None	None	None	USB / USB	None	180W	Win8.1 DG Win7 Pro 64	3-year, Onsite	10/14
10CV000TUS	US	A10 PRO-7800B	No	AMD R7 Graphics	None	4GBx1	500GB 7200rpm 3.5"	DVD±RW	9-in-1	None	None	None	None	USB / USB	Floor Stand	180W	Win8.1 DG Win7 Pro 64	3-year, Onsite	02/15
10CV000UUS	US	A10 PRO-7800B	No	AMD R7 Graphics	None	8GBx1	500GB 7200rpm 3.5"	DVD±RW	9-in-1	None	None	None	None	USB / USB	Floor Stand	180W	Win8.1 DG Win7 Pro 64	3-year, Onsite	02/15
10CV000VUS	US	A6 PRO-7400B	No	AMD R5 Graphics	None	4GBx1	500GB 7200rpm 3.5"	DVD±RW	9-in-1	None	None	None	None	USB / USB	None	180W	Win8.1 DG Win7 Pro 64	3-year, Onsite	02/15
10CV000WUS	US	A8 PRO-7600B	No	AMD R7 Graphics	None	4GBx1	500GB 7200rpm 3.5"	DVD±RW	None	None	2 Rear USB 2.0	None	Cable Lock	USB / USB	Floor Stand	180W	Win8.1 DG Win7 Pro 64	3-year, Onsite	02/15
10CV000XUS	US	A8 PRO-7600B	No	AMD R7 Graphics	None	4GBx1	500GB 7200rpm 3.5"	DVD±RW	None	None	None	Switch	None	USB / USB	Floor Stand	180W	Win8.1 DG Win7 Pro 64	3-year, Onsite	07/15

ThinkCentre M79 SFF - TopSeller - 10JB

Product Specifications Reference (PSREF)

Model	Region	Processor	vPro	Graphics	Monitor Cable	Memory	Storage	Optical	Media Reader	WLAN + Bluetooth	Optional Rear Ports	Chassis Intrusion Switch	Cable Lock	Keyboard / Mouse	Stand	Power Supply	Operating System	Warranty	Ann Date (m/y)
10JB0005US	US	PRO A10-8750B	No	AMD R7 Graphics	None	4GBx1	500GB 7200rpm 3.5"	DVD±RW	None	RTL8723BE b/g/n, 1x1 + BT4.0	None	Switch	Cable Lock	USB / USB	None	240W 85%	Win10 DG Win7 Pro 64	3-year, Onsite	10/15
10JB0006US	US	PRO A4-8350B	No	AMD R5 Graphics	None	4GBx1	500GB 7200rpm 3.5"	DVD±RW	None	RTL8723BE b/g/n, 1x1 + BT4.0	2nd DP	Switch	Cable Lock	USB / USB	None	240W 85%	Win10 DG Win7 Pro 64	3-year, Onsite	10/15
10JB0007US	US	PRO A8-8650B	No	AMD R7 Graphics	None	4GBx1	500GB 7200rpm 3.5"	DVD±RW	None	RTL8723BE b/g/n, 1x1 + BT4.0	2nd DP + 1394	Switch	Cable Lock	USB / USB	None	240W 85%	Win10 DG Win7 Pro 64	3-year, Onsite	10/15
10JB0008US	US	PRO A6-8550B	No	AMD R5 Graphics	None	4GBx1	500GB 7200rpm 3.5"	DVD±RW	None	RTL8723BE b/g/n, 1x1 + BT4.0	2nd DP	Switch	Cable Lock	USB / USB	None	240W 85%	Win10 DG Win7 Pro 64	3-year, Onsite	10/15
10JB0009US	US	A4 PRO-7300B	No	AMD HD 8470D	DP to DVI	4GBx1	500GB 7200rpm 3.5"	DVD±RW	None	RTL8723BE b/g/n, 1x1 + BT4.0	None	None	None	USB / USB	None	240W 85%	Win10 Pro 64	3-year, Onsite	09/15
10JB000AUS	US	A6 PRO-7400B	No	AMD R5 Graphics	DP to DVI	4GBx1	500GB 7200rpm 3.5"	DVD±RW	None	RTL8723BE b/g/n, 1x1 + BT4.0	None	None	None	USB / USB	None	240W 85%	Win10 Pro 64	3-year, Onsite	09/15
10JB000BUS	US	A4 PRO-7300B	No	AMD HD 8470D	DP to DVI	4GBx1	500GB 7200rpm 3.5"	DVD±RW	None	RTL8723BE b/g/n, 1x1 + BT4.0	None	None	None	USB / USB	None	240W 85%	Win10 DG Win7 Pro 64	3-year, Onsite	10/15
10JB000CUS	US	A6 PRO-7400B	No	AMD R5 Graphics	DP to DVI	4GBx1	500GB 7200rpm 3.5"	DVD±RW	None	RTL8723BE b/g/n, 1x1 + BT4.0	None	None	None	USB / USB	None	240W 85%	Win10 DG Win7 Pro 64	3-year, Onsite	10/15
10JB000DUS	US	A10 PRO-7800B	No	AMD R7 Graphics	DP to DVI	4GBx1	500GB 7200rpm 3.5"	DVD±RW	None	RTL8723BE b/g/n, 1x1 + BT4.0	None	None	None	USB / USB	None	240W 85%	Win10 Pro 64	3-year, Onsite	09/15
10JB000EUS	US	A10 PRO-7800B	No	AMD R7 Graphics	DP to DVI	4GBx1	500GB 7200rpm 3.5"	DVD±RW	None	RTL8723BE b/g/n, 1x1 + BT4.0	None	None	None	USB / USB	None	240W 85%	Win10 DG Win7 Pro 64	3-year, Onsite	10/15
10JB000FUS	US	A8 PRO-7600B	No	AMD R7 Graphics	DP to DVI	4GBx1	500GB 7200rpm 3.5"	DVD±RW	None	RTL8723BE b/g/n, 1x1 + BT4.0	None	None	None	USB / USB	None	240W 85%	Win10 Pro 64	3-year, Onsite	09/15
10JB000GUS	US	A8 PRO-7600B	No	AMD R7 Graphics	DP to DVI	4GBx1	500GB 7200rpm 3.5"	DVD±RW	None	RTL8723BE b/g/n, 1x1 + BT4.0	None	None	None	USB / USB	None	240W 85%	Win10 DG Win7 Pro 64	3-year, Onsite	10/15
10JB000HUS	US	A10 PRO-7800B	No	AMD R7 Graphics	None	4GBx1	500GB 7200rpm 3.5"	DVD±RW	9-in-1	None	None	None	None	USB / USB	None	240W 85%	Win10 DG Win7 Pro 64	3-year, Onsite	12/15
10JB000JUS	US	A8 PRO-7600B	No	AMD R7 Graphics	None	4GBx1	500GB 7200rpm 3.5"	DVD±RW	9-in-1	None	None	None	None	USB / USB	None	240W 85%	Win10 DG Win7 Pro 64	3-year, Onsite	12/15
10JB000KUS	US	A4 PRO-7300B	No	AMD HD 8470D	None	4GBx1	500GB 7200rpm 3.5"	DVD±RW	9-in-1	None	None	None	None	USB / USB	None	240W 85%	Win10 DG Win7 Pro 64	3-year, Onsite	12/15
10JB000LUS	US	A6 PRO-7400B	No	AMD R5 Graphics	None	4GBx1	500GB 7200rpm 3.5"	DVD±RW	9-in-1	None	None	None	None	USB / USB	None	240W 85%	Win10 DG Win7 Pro 64	3-year, Onsite	12/15

Model	Region	Processor	vPro	Graphics	Monitor Cable	Memory	Storage	Optical	Media Reader	WLAN + Bluetooth	Optional Rear Ports	Chassis Intrusion Switch	Cable Lock	Keyboard / Mouse	Stand	Power Supply	Operating System	Warranty	Ann Date (m/y)
10CT0006US	US	A4-6300B	No	AMD HD 8370D	None	2GBx1	250GB 7200rpm 3.5"	DVD	None	None	None	Switch	None	USB / USB	None	240W 85%	Win7 Pro 32	3-year, Onsite	07/14
10CT0007US	US	A6 PRO-7400B	No	AMD R5 Graphics	None	2GBx1	500GB 7200rpm 3.5"	DVD±RW	None	None	None	Switch	None	USB / USB	None	240W 85%	Win7 Pro 32	3-year, Onsite	07/14
10CT0008US	US	A6-6400B	No	AMD HD 8470D	None	4GBx1	500GB 7200rpm 3.5"	DVD±RW	None	None	None	None	None	USB / USB	None	240W 85%	Win8.1 DG Win7 Pro 64	3-year, Onsite	08/14
10CT0009US	US	A6-6400B	No	AMD HD 8470D	None	4GBx1	500GB 7200rpm 3.5"	DVD±RW	None	RTL8723BE b/g/n, 1x1 + BT4.0	None	None	None	USB / USB	None	240W 85%	Win8.1 DG Win7 Pro 64	3-year, Onsite	08/14
10CT000AUS	US	A8 PRO-7600B	No	AMD R7 Graphics	None	8GBx1	500GB 7200rpm 3.5"	DVD±RW	None	None	None	None	None	USB / USB	None	240W 85%	Win8.1 DG Win7 Pro 64	3-year, Onsite	08/14
10CT000BUS	US	A8 PRO-7600B	No	GT 620 1GB	None	8GBx1	500GB 7200rpm 3.5"	DVD±RW	None	RTL8723BE b/g/n, 1x1 + BT4.0	None	None	None	USB / USB	None	240W 85%	Win8.1 DG Win7 Pro 64	3-year, Onsite	08/14

Model	Region	Processor	vPro	Graphics	Monitor Cable	Memory	Storage	Optical	Media Reader	WLAN + Bluetooth	Optional Rear Ports	Chassis Intrusion Switch	Cable Lock	Keyboard / Mouse	Stand	Power Supply	Operating System	Warranty	Ann Date (m/y)
10CW000BUS	US	A4-6300B	No	AMD HD 8370D	None	4GBx1	500GB 7200rpm 3.5"	DVD±RW	None	None	None	None	None	USB / USB	None	180W	Win8.1 DG Win7 Pro 64	3-year, Onsite	08/14

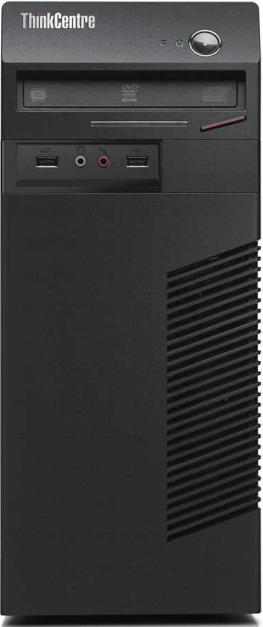

ThinkCentre M79 Tower Platform Specifications

Product Specifications Reference (PSREF)

Processor	AMD A4, A6, A8, or A10 series APUs	<ul style="list-style-type: none"> • Cable lock to physically lock both keyboard and mouse (optional) • Power-on password • Boot without keyboard and mouse • Individual USB port disablement • Optional <i>Chassis intrusion switch</i> 																																																																								
	<table border="1"> <thead> <tr> <th>APU</th> <th>Cores</th> <th>Frequency (Max/Base)</th> <th>L2 Cache</th> <th>Memory Types</th> <th>Integrated Graphics</th> </tr> </thead> <tbody> <tr> <td>A4-6300B</td> <td>2</td> <td>3.9 / 3.7</td> <td>1MB</td> <td>DDR3-1600</td> <td>HD 8370D</td> </tr> <tr> <td>A4 PRO-7300B</td> <td>2</td> <td>4.0 / 3.8</td> <td>1MB</td> <td>DDR3-1600</td> <td>HD 8470D</td> </tr> <tr> <td>PRO A4-8350B</td> <td>2</td> <td>3.9 / 3.5</td> <td>1MB</td> <td>DDR3-1866</td> <td>Radeon R5 Series</td> </tr> <tr> <td>A6-6400B</td> <td>2</td> <td>4.1 / 3.9</td> <td>1MB</td> <td>DDR3-1866</td> <td>HD 8470D</td> </tr> <tr> <td>A6 PRO-7400B</td> <td>2</td> <td>3.9 / 3.5</td> <td>1MB</td> <td>DDR3-1866</td> <td>Radeon R5 Series</td> </tr> <tr> <td>PRO A6-8550B</td> <td>2</td> <td>4.0 / 3.7</td> <td>1MB</td> <td>DDR3-2133</td> <td>Radeon R5 Series</td> </tr> <tr> <td>A8-6500B</td> <td>4</td> <td>4.1 / 3.5</td> <td>4MB</td> <td>DDR3-1866</td> <td>HD 8570D</td> </tr> <tr> <td>A8 PRO-7600B</td> <td>4</td> <td>3.8 / 3.1</td> <td>4MB</td> <td>DDR3-2133</td> <td>Radeon R7 Series</td> </tr> <tr> <td>PRO A8-8650B</td> <td>4</td> <td>3.9 / 3.2</td> <td>4MB</td> <td>DDR3-2133</td> <td>Radeon R7 Series</td> </tr> <tr> <td>A10 PRO-7800B</td> <td>4</td> <td>3.9 / 3.5</td> <td>4MB</td> <td>DDR3-2133</td> <td>Radeon R7 Series</td> </tr> <tr> <td>PRO A10-8750B</td> <td>4</td> <td>4.0 / 3.6</td> <td>4MB</td> <td>DDR3-2133</td> <td>Radeon R7 Series</td> </tr> </tbody> </table>	APU	Cores	Frequency (Max/Base)	L2 Cache	Memory Types	Integrated Graphics	A4-6300B	2	3.9 / 3.7	1MB	DDR3-1600	HD 8370D	A4 PRO-7300B	2	4.0 / 3.8	1MB	DDR3-1600	HD 8470D	PRO A4-8350B	2	3.9 / 3.5	1MB	DDR3-1866	Radeon R5 Series	A6-6400B	2	4.1 / 3.9	1MB	DDR3-1866	HD 8470D	A6 PRO-7400B	2	3.9 / 3.5	1MB	DDR3-1866	Radeon R5 Series	PRO A6-8550B	2	4.0 / 3.7	1MB	DDR3-2133	Radeon R5 Series	A8-6500B	4	4.1 / 3.5	4MB	DDR3-1866	HD 8570D	A8 PRO-7600B	4	3.8 / 3.1	4MB	DDR3-2133	Radeon R7 Series	PRO A8-8650B	4	3.9 / 3.2	4MB	DDR3-2133	Radeon R7 Series	A10 PRO-7800B	4	3.9 / 3.5	4MB	DDR3-2133	Radeon R7 Series	PRO A10-8750B	4	4.0 / 3.6	4MB	DDR3-2133	Radeon R7 Series	<p>Keyboard</p> <p>Some: Preferred Pro USB Keyboard (USB connector), Lenovo logo</p> <p>Some: Lenovo USB Fingerprint Keyboard (USB connector)</p> <p>Some: Ultralim Plus Wireless Keyboard (2.4GHz via USB receiver), black</p> <p>Mouse</p> <p>Some: Enhanced Optical USB Mouse, black, Lenovo logo</p> <p>Some: Ultralim Plus Wireless Mouse (2.4GHz via USB receiver), black</p>
APU	Cores	Frequency (Max/Base)	L2 Cache	Memory Types	Integrated Graphics																																																																					
A4-6300B	2	3.9 / 3.7	1MB	DDR3-1600	HD 8370D																																																																					
A4 PRO-7300B	2	4.0 / 3.8	1MB	DDR3-1600	HD 8470D																																																																					
PRO A4-8350B	2	3.9 / 3.5	1MB	DDR3-1866	Radeon R5 Series																																																																					
A6-6400B	2	4.1 / 3.9	1MB	DDR3-1866	HD 8470D																																																																					
A6 PRO-7400B	2	3.9 / 3.5	1MB	DDR3-1866	Radeon R5 Series																																																																					
PRO A6-8550B	2	4.0 / 3.7	1MB	DDR3-2133	Radeon R5 Series																																																																					
A8-6500B	4	4.1 / 3.5	4MB	DDR3-1866	HD 8570D																																																																					
A8 PRO-7600B	4	3.8 / 3.1	4MB	DDR3-2133	Radeon R7 Series																																																																					
PRO A8-8650B	4	3.9 / 3.2	4MB	DDR3-2133	Radeon R7 Series																																																																					
A10 PRO-7800B	4	3.9 / 3.5	4MB	DDR3-2133	Radeon R7 Series																																																																					
PRO A10-8750B	4	4.0 / 3.6	4MB	DDR3-2133	Radeon R7 Series																																																																					
Memory	32GB max, UDIMM, PC3-12800 1600MHz DDR3, four 240-pin DIMM sockets																																																																									
Disk	Some: SATA 6.0Gb/s, 3.5" Wide, 7200 rpm																																																																									
	Some: hybrid hard disk / with 8GB MLC NAND flash memory, SATA 6.0Gb/s, 5400 rpm 2.5" wide or 7200 rpm 3.5" wide																																																																									
Optical	Some: Solid State Drive (SSD) / SATA 6.0Gb/s, 2.5" Wide																																																																									
Onboard SATA Media reader	Some: DVD-ROM SATA 1.5Gb/s Drive																																																																									
	Some: Super Multi-Burner DVD±RW SATA 1.5Gb/s Drive																																																																									
	SATA 6.0Gb/s controller, three connectors on planar, RAID 0/1 support																																																																									
	Optional 7-in-1 single slot media card reader																																																																									
Graphics	<p>AMD Radeon™ Graphics in processor, uses main memory, one VGA, one DisplayPort™, one optional DP, supports up to three independent displays, works along with optional discrete graphics to support up to five independent displays;</p> <p><i>Maximum resolution: 1920x1200 (VGA)@60Hz; 2560x2048 (DisplayPort)@60Hz</i></p> <p>Some: AMD Radeon HD 8570, DirectX 11, 3D Hardware Acceleration, 2GB, PCI Express 3.0 x16 adapter (8x elec), one VGA, one HDMI, 40W; <i>Max resolution: 4096x2160 (HDMI)@24Hz; 2048x1536 (VGA)@85Hz</i></p> <p>Some: NVIDIA® GeForce® GT 620, DirectX 11, 3D Hardware Acceleration, 1GB, PCI Express 2.0 x16 adapter, one VGA, one DisplayPort, 30 watts; <i>Max resolution: 2560x1600 (DisplayPort)@60Hz; 2048x1536 (VGA)@85Hz</i></p> <p>Some: AMD Radeon™ HD 7450, DirectX 11, 3D Hardware Acceleration, 1GB, PCI Express 2.0 x16 adapter, one DVI-I (includes DVI-to-VGA dongle), one DisplayPort, 25 watts; <i>Max resolution: 2560x1600 (DisplayPort, DVI-I)@60Hz</i></p>	<p>Power supply</p> <p>Some: 180 watts, autosensing, 100-240V (50-60Hz)</p> <p>Some: 280 watts, autosensing, 100-240V (50-60Hz)</p> <p>Some: 280 watts, autosensing, 85% PSU, 100-240V (50-60Hz)</p>																																																																								
DP cable	Optional DisplayPort to DVI-D monitor cable	<p>Limited warranty³</p> <p>Some: 3-years, limited onsite service / service upgrades available</p> <p>Some: 3-years, limited onsite service, OID (Onsite International Delivery) / service upgrades available</p> <p><i>For Lenovo service upgrade options, please go to S-TC sheet</i></p>																																																																								
Chipset	AMD A78 FCH	<p>Preload</p> <p>Some: Windows® 7 Professional 32/64 preinstalled through downgrade rights in Windows 8.1 Pro 64-bit</p> <p>Some: Windows 7 Professional 32</p> <p>Some: Windows 7 Professional 64</p> <p>Ready to install applications (only some listed)</p> <ul style="list-style-type: none"> • Rescue and Recovery™ • Password Manager <p>Preloaded applications (only some listed)</p> <ul style="list-style-type: none"> • ThinkVantage® Product Recovery • ThinkVantage System Update • ThinkVantage Communication Utility • ThinkVantage Device Experience • Desktop Power Manager • View Management Utility • Lenovo Solution Center • Lenovo Message Center Plus • Norton™ Internet Security (30 days of virus definitions) • Adobe® Reader® • Skype™ • Microsoft Office preloaded; purchase a product key to activate • Cyberlink Power2Go (DVD±RW) • Cyberlink PowerProducer (DVD±RW) • Evernote® • Nitro Pro 																																																																								
Front ports	Two USB 2.0, microphone (stereo, 3.5mm), headphone (stereo, 3.5mm)	<p>Some: Windows 8.1 64-bit preinstalled through downgrade rights in Windows 8.1 Pro 64-bit</p> <p>Some: Windows 10 Pro 64-bit</p> <p>Preloaded applications (only some listed)</p> <ul style="list-style-type: none"> • Desktop Power Manager • Lenovo Solution Center • Lenovo Companion • Lenovo SHAREit • Lenovo REACHit • McAfee® LiveSafe™(30-day trial) • Microsoft Office preloaded; purchase a product key to activate • Cyberlink PowerDVD (DVD±RW, DVD) • Cyberlink Power2Go (DVD±RW) • Cyberlink PowerProducer (DVD±RW) • PC Device Stage 																																																																								
Rear ports	Up to six USB ports (2x USB 3.0 + 2x USB 2.0 + 2x optional USB 2.0), serial (9-pin), optional 2nd serial (9-pin), optional parallel (25-pin), ethernet (RJ-45), VGA, DisplayPort (1x standard + 1x optional), two PS/2 ports	<p>Environment</p> <p>ENERGY STAR® 6.0 (Need 85% PSU and Windows OS);</p> <p>EPEAT™ Gold rating (Need 85% PSU and Windows OS);</p> <p>GREENGUARD®; RoHS-compliant; Cisco EnergyWise compatible; ErP Lot 3</p>																																																																								
Rear audio ports	Line-in (stereo, 3.5mm), line-out (stereo, 3.5mm), microphone (stereo, 3.5mm)	<p>Accessories</p> <p>For compatible accessories, please go to TC-AQP sheet</p>																																																																								
IEEE 1394	Optional FireWire PCIe adapter, 1394a-2000, 400Mbps, two 6-pin ports on rear																																																																									
Audio support	High Definition (HD) Audio, Realtek ALC662 / internal speaker (1.5watt)																																																																									
WLAN ¹³	Some: 11b/g/n wireless, Realtek RTL8723BE, Wi-Fi + BT 4.0 combo, 1x1																																																																									
	Some: 11b/g/n wireless, Realtek RTL8192EE, Wi-Fi + BT 4.0 combo, 2x2																																																																									
	Some: 11ac/b/g/n wireless, Broadcom BCM4352, 2.4/5GHz, Wi-Fi + BT 4.0, 2x2																																																																									
Bluetooth™	Some: Bluetooth 4.0 wireless, integrated in Wi-Fi + Bluetooth combo adapter																																																																									
Ethernet	One gigabit ethernet port, Realtek 8111EPV, Wake on LAN®																																																																									
Modem	None																																																																									
Manageability	Enhanced Manageability with DASH 1.1																																																																									
Security chip	Trusted Platform Module, TCG 1.2-compliant																																																																									
Security features	<ul style="list-style-type: none"> • Padlock loop (in rear for opt padlock) • Security slot (in rear for optional Kensington® MicroSaver® cable) • Administrator password • Hard disk password • Boot sequence control 																																																																									

See footnotes for more detailed information

(ALSK1-TW) September 2015 © Lenovo

ThinkCentre M79 Tower - TopSeller - 10CN

Product Specifications Reference (PSREF)

Model	Region	Processor	vPro	Graphics	Monitor Cable	Memory	Storage	Optical	Media Reader	WLAN + Bluetooth	Optional Rear Ports	Chassis Intrusion Switch	Cable Lock	Keyboard / Mouse	Power Supply	Operating System	Warranty	Ann Date (m/y)
10CN0000US	US	A4-6300B	No	AMD HD 8370D	None	4GBx1	500GB 7200rpm 3.5"	DVD±RW	None	None	None	None	None	USB / USB	180W	Win8.1 DG Win7 Pro 64	3-year, Onsite	07/14
10CN0001US	US	AMD A8-6500B	No	AMD HD 8570D	None	4GBx1	500GB 7200rpm 3.5"	DVD±RW	None	None	None	None	None	USB / USB	180W	Win8.1 DG Win7 Pro 64	3-year, Onsite	07/14
10CN0002US	US	A8 PRO-7600B	No	AMD R7 Graphics	None	4GBx1	500GB 7200rpm 3.5"	DVD±RW	None	None	None	None	None	USB / USB	280W	Win8.1 DG Win7 Pro 64	3-year, Onsite	07/14
10CN0003US	US	A6-6400B	No	AMD HD 8470D	None	4GBx1	500GB 7200rpm 3.5"	DVD±RW	None	None	None	None	None	USB / USB	180W	Win8.1 DG Win7 Pro 64	3-year, Onsite	07/14
10CN000VUS	US	A10 PRO-7800B	No	AMD R7 Graphics	None	4GBx1	500GB 7200rpm 3.5"	DVD±RW	None	None	None	None	None	USB / USB	280W	Win8.1 DG Win7 Pro 64	3-year, Onsite	11/14
10CN000WUS	US	A10 PRO-7800B	No	AMD R7 Graphics	None	8GBx1	500GB 7200rpm 3.5"	DVD±RW	None	None	None	None	None	USB / USB	280W	Win8.1 DG Win7 Pro 64	3-year, Onsite	11/14
10CN000XUS	US	A6 PRO-7400B	No	AMD R5 Graphics	None	4GBx1	500GB 7200rpm 3.5"	DVD±RW	None	None	None	None	None	USB / USB	180W	Win8.1 DG Win7 Pro 64	3-year, Onsite	02/15
10CN000YUS	US	A8 PRO-7600B	No	AMD R7 Graphics	None	4GBx1	500GB 7200rpm 3.5"	DVD±RW	9-in-1	None	None	None	None	USB / USB	180W	Win8.1 DG Win7 Pro 64	3-year, Onsite	07/15

Model	Region	Processor	vPro	Graphics	Monitor Cable	Memory	Storage	Optical	Media Reader	WLAN + Bluetooth	Optional Rear Ports	Chassis Intrusion Switch	Cable Lock	Keyboard / Mouse	Power Supply	Operating System	Warranty	Ann Date (m/y)
10J70009US	US	PRO A4-8350B	No	AMD R5 Graphics	None	4GBx1	500GB 7200rpm 3.5"	DVD±RW	None	RTL8723BE b/g/n, 1x1 + BT4.0	None	Switch	Cable Lock	USB / USB	280W 85%	Win10 DG Win7 Pro 64	3-year, Onsite	10/15
10J7000AUS	US	PRO A8-8650B	No	AMD R7 Graphics	None	4GBx1	500GB 7200rpm 3.5"	DVD±RW	None	RTL8723BE b/g/n, 1x1 + BT4.0	None	Switch	Cable Lock	USB / USB	280W 85%	Win10 DG Win7 Pro 64	3-year, Onsite	10/15
10J7000BUS	US	PRO A10-8750B	No	AMD R7 Graphics	None	4GBx1	500GB 7200rpm 3.5"	DVD±RW	None	RTL8723BE b/g/n, 1x1 + BT4.0	None	Switch	Cable Lock	USB / USB	280W 85%	Win10 DG Win7 Pro 64	3-year, Onsite	10/15
10J7000CUS	US	PRO A6-8550B	No	AMD R5 Graphics	None	4GBx1	500GB 7200rpm 3.5"	DVD±RW	None	RTL8723BE b/g/n, 1x1 + BT4.0	None	Switch	Cable Lock	USB / USB	280W 85%	Win10 DG Win7 Pro 64	3-year, Onsite	10/15
10J7000DUS	US	A4 PRO-7300B	No	AMD HD 8470D	DP to DVI	4GBx1	500GB 7200rpm 3.5"	DVD±RW	None	RTL8723BE b/g/n, 1x1 + BT4.0	None	None	None	USB / USB	280W 85%	Win10 Pro 64	3-year, Onsite	09/15
10J7000EUS	US	A8 PRO-7600B	No	AMD R7 Graphics	DP to DVI	4GBx1	500GB 7200rpm 3.5"	DVD±RW	None	RTL8723BE b/g/n, 1x1 + BT4.0	None	None	None	USB / USB	280W 85%	Win10 Pro 64	3-year, Onsite	07/16
10J7000FUS	US	A6 PRO-7400B	No	AMD R5 Graphics	DP to DVI	4GBx1	500GB 7200rpm 3.5"	DVD±RW	None	RTL8723BE b/g/n, 1x1 + BT4.0	None	None	None	USB / USB	280W 85%	Win10 Pro 64	3-year, Onsite	09/15
10J7000GUS	US	A4 PRO-7300B	No	AMD HD 8470D	DP to DVI	4GBx1	500GB 7200rpm 3.5"	DVD±RW	None	RTL8723BE b/g/n, 1x1 + BT4.0	None	None	None	USB / USB	280W 85%	Win10 DG Win7 Pro 64	3-year, Onsite	10/15
10J7000HUS	US	A10 PRO-7800B	No	AMD R7 Graphics	DP to DVI	4GBx1	500GB 7200rpm 3.5"	DVD±RW	None	RTL8723BE b/g/n, 1x1 + BT4.0	None	None	None	USB / USB	280W 85%	Win10 Pro 64	3-year, Onsite	09/15
10J7000JUS	US	A6 PRO-7400B	No	AMD R5 Graphics	DP to DVI	4GBx1	500GB 7200rpm 3.5"	DVD±RW	None	RTL8723BE b/g/n, 1x1 + BT4.0	None	None	None	USB / USB	280W 85%	Win10 DG Win7 Pro 64	3-year, Onsite	10/15
10J7000KUS	US	A10 PRO-7800B	No	AMD R7 Graphics	DP to DVI	4GBx1	500GB 7200rpm 3.5"	DVD±RW	None	RTL8723BE b/g/n, 1x1 + BT4.0	None	None	Cable Lock	USB / USB	280W 85%	Win10 DG Win7 Pro 64	3-year, Onsite	10/15
10J7000LUS	US	A8 PRO-7600B	No	AMD R7 Graphics	DP to DVI	4GBx1	500GB 7200rpm 3.5"	DVD±RW	None	RTL8723BE b/g/n, 1x1 + BT4.0	None	None	None	USB / USB	280W 85%	Win10 DG Win7 Pro 64	3-year, Onsite	10/15

ThinkCentre M79 Tower - 10CQ

Product Specifications Reference (PSREF)

Model	Region	Processor	vPro	Graphics	Monitor Cable	Memory	Storage	Optical	Media Reader	WLAN + Bluetooth	Optional Rear Ports	Chassis Intrusion Switch	Cable Lock	Keyboard / Mouse	Power Supply	Operating System	Warranty	Ann Date (m/y)
10CQ0005US	US	A4-6300B	No	AMD HD 8370D	None	2GBx1	250GB 7200rpm 3.5"	DVD	None	None	None	Switch	None	USB / USB	280W 85%	Win7 Pro 32	3-year, Onsite, OID	07/14
10CQ0006US	US	A6 PRO-7400B	No	AMD R5 Graphics	None	2GBx1	500GB 7200rpm 3.5"	DVD±RW	None	None	None	Switch	None	USB / USB	280W 85%	Win7 Pro 32	3-year, Onsite, OID	07/14
10CQ0007US	US	A8 PRO-7600B	No	AMD HD 8570 2GB	None	4GBx1	1TB 7200rpm 3.5"	DVD±RW	9 in 1	None	Parallel	Switch	None	USB / USB	280W 85%	Win7 Pro 64	3-year, Onsite, OID	07/14

ThinkCentre M79 Tower - 10CS

Product Specifications Reference (PSREF)

Model	Region	Processor	vPro	Graphics	Monitor Cable	Memory	Storage	Optical	Media Reader	WLAN + Bluetooth	Optional Rear Ports	Chassis Intrusion Switch	Cable Lock	Keyboard / Mouse	Power Supply	Operating System	Warranty	Ann Date (m/y)
10CS0003US	US	A4-6300B	No	AMD HD 8370D	None	4GBx1	500GB 7200rpm 3.5"	DVD±RW	None	None	None	None	None	USB / USB	180W	Win8.1 DG Win7 Pro 64	3-year, Onsite	08/14



ThinkCentre M800 SFF Platform Specifications

Product Specifications Reference (PSREF)

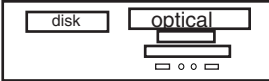
Processor	Intel® Celeron®, Intel Pentium®, or 6th Generation Intel Core™ i3 / i5 / i7 Processor						Manageability Intel Standard Manageability Security chip Trusted Platform Module, TCG 1.2-compliant Security features <ul style="list-style-type: none"> • One lock to secure both cover and entire system to fixed object: <ul style="list-style-type: none"> -Padlock loop (in rear for opt padlock) -Security slot (in rear for optional Kensington® MicroSaver® cable) • Power-on password • Administrator password • Hard disk password • Boot sequence control • Boot without keyboard and mouse • Individual USB port disablement • Optional chassis intrusion switch
	Processor	Cores / Threads	Frequency Base/Max(GHz)	Cache	Memory Types	Integrated Graphics	
	Pentium G4400	2 / 2	3.3G	3 MB	DDR4-2133	HD 510	
	Pentium G4500	2 / 2	3.5G	3 MB	DDR4-2133	HD 530	
	Core i3-6100	2 / 4	3.7 G	3 MB	DDR4-2133	HD 530	
	Core i3-6300	2 / 4	3.8 G	4 MB	DDR4-2133	HD 530	
	Core i5-6400	4 / 4	2.7 G / 3.3 G	6 MB	DDR4-2133	HD 530	
	Core i5-6500	4 / 4	3.2 G / 3.6 G	6 MB	DDR4-2133	HD 530	
Core i5-6600	4 / 4	3.3 G / 3.9 G	6 MB	DDR4-2133	HD 530		
Core i7-6700	4 / 8	3.4 G / 4.0 G	8 MB	DDR4-2133	HD 530		
Memory	64GB max, UDIMM, DDR4 2133, four 288-pin DIMM sockets, dual-channel capable						
Disk	<i>Some:</i> Hard disk, SATA 6.0Gb/s, 2.5"/ 3.5" wide, 5400 / 7200 rpm <i>Some:</i> Solid State Hybrid Drive (SSHD), 500GB (5400 rpm, 2.5") / 1TB or 2TB (7200 rpm, 3.5"), with 8GB NAND flash memory, SATA 6.0Gb/s <i>Some:</i> Solid State Drive (SSD) / SATA 6.0Gb/s, 2.5" Wide <i>Some:</i> DVD-ROM SATA 1.5Gb/s Drive <i>Some:</i> Super Multi-Burner DVD±RW SATA 1.5Gb/s Drive						
Optical							
Onboard SATA	Four onboard SATA 6.0Gb/s connectors, one is eSATA connector for optional rear eSATA port						
Media reader	Optional 9-in-1 media reader						
Graphics	Intel HD Graphics 510/530 in processor, uses main memory, DirectX® 12, one VGA, two DisplayPort™, supports three independent displays, works along with discrete graphics to support more displays; <i>Max resolution:</i> 4096x2304 (DP) @60Hz; 1920x1200 (VGA) @60Hz <i>Some:</i> NVIDIA® Quadro® K420 , DirectX 12, 2GB, PCIe 2.0 x16 adapter, one DVI-I, one DisplayPort, 41 watts; <i>Max resolution:</i> 3840x2160 (DisplayPort) @60Hz; 2560x1600 (DVI-I) @60Hz <i>Some:</i> NVIDIA GeForce® GT 720 , DirectX 12, 2GB, PCIe 2.0 x8 adapter, one VGA, one HDMI, 25 watts; <i>Max resolution:</i> 1920x1080 (HDMI) @60Hz; 2048x1536 (VGA) @85Hz <i>Some:</i> NVIDIA GeForce GT 720 , DirectX 12, 1GB, PCIe 2.0 x8 adapter, two DisplayPort, 25 watts; <i>Max resolution:</i> 3840x2160 (DisplayPort) @60Hz;						
DP cable	Optional DP to VGA, DP to DVI-D (single link), or DP to HDMI 1.4 dongle						
Chipset	Intel Q150 Chipset						
Front ports	Two USB 3.0, two optional USB 2.0, microphone (3.5mm), headphone (3.5mm)						
Rear ports	Four USB 3.0, two USB 2.0, two optional USB 2.0, serial (9-pin), optional 2nd serial (9-pin), optional parallel (25-pin), ethernet (RJ-45), one VGA, two DisplayPort, optional PS/2 ports (keyboard/mouse), one optional eSATA port additional VGA, DisplayPort, DVI-I or HDMI on optional graphics on some models						
Rear audio ports	Line-in (3.5mm), line-out (3.5mm), microphone-in (3.5mm)						
IEEE 1394	None						
Audio support	High Definition (HD) Audio, Realtek ALC662 / optional internal speaker (1.5 watt)						
WLAN ¹³	<i>Some:</i> 11ac wireless, M.2 Card, Qualcomm Atheros QCA9377 (dual band), Wi-Fi + Bluetooth 4.1 combo adapter, 1x1 <i>Some:</i> 11ac wireless, M.2 Card, Qualcomm Atheros QCA6174 (dual band), Wi-Fi + Bluetooth 4.1 combo adapter, 2x2 <i>Some:</i> 11ac wireless, M.2 Card, Intel Dual Band Wireless-AC 3165, Wi-Fi + Bluetooth 4.0 combo adapter, 1x1 <i>Some:</i> 11ac wireless, M.2 Card, Intel Dual Band Wireless-AC 8260, Wi-Fi + Bluetooth 4.1 combo adapter, 2x2						
Bluetooth™	<i>Some:</i> Bluetooth 4.0 or 4.1 wireless, integrated in Wi-Fi + BT combo adapter						
Ethernet	Gigabit ethernet, Intel Ethernet Connection I219-LM (Jacksonville), Wake on LAN®						
Modem	None						
Mechanical	<ul style="list-style-type: none"> • SFF (9.7L), black color; metal case • (WxDxH) 13.31" X 14.05" X 3.46"; 338mm X 357mm X 88mm • 12.3 lb (5.6 kg) • Toolless cover, disk, optical removal • Toolless graphics, PCI adapter retention • Optional dust filter Bay 1: N/A, 9.5mm high, external, std optical Bay 2: 3.5", 1" high, internal, std disk Bay 3: 2.5", N/A, internal, opt 2nd 2.5" disk (optional bay) Bay 4: N/A, N/A, external, opt reader Slot 1: Low Profile, PCI Express 3.0 x16 (45w max) Slot 2: Low Profile, PCIe 3.0 x1 Slot 3: Low Profile, PCIe 3.0 x16 (x4 elec, 45w max) Slot 4: Low Profile, optional 32-bit PCI 2.3 (via M.2 to PCI adaptor) 						
Floor Stand	Optional system floor stand for vertical orientation						
Power supply	210 watts, autosensing, 85% PSU						
Limited warranty ³	<i>Some:</i> 1-year or 3-year, limited onsite service / service upgrades available <i>Some:</i> 3-year, limited onsite service, OID (Onsite International Delivery) / service upgrades available <i>For Lenovo service upgrade options, please go to S-TC sheet</i>						
Preload	Preloaded operating system <i>Some:</i> Windows® 7 Professional 64 preinstalled through downgrade rights in Windows 10 Pro 64-bit <i>Some:</i> Windows 7 Professional 64 <i>Some:</i> Windows 10 Pro 64-bit <i>Some:</i> Windows 10 Home 64-bit		Preloaded applications (only some listed) <ul style="list-style-type: none"> • Desktop Power Manager • Lenovo Solution Center • Lenovo REACHit • Lenovo SHAREit • Lenovo Bluetooth Lock (for models with Wi-Fi/BT card) • McAfee® LiveSafe™ (30-day trial) • Microsoft Office preloaded; purchase a product key to activate • PowerDVD Create (DVD±RW) • Lenovo ThinkVantage Tools <ul style="list-style-type: none"> - Only for Window 10 • Lenovo Companion • Cyberlink PowerDVD (DVD, DVD±RW) • Lenovo QuickOptimizer <ul style="list-style-type: none"> - Only for Window 7 • Rescue and Recovery • Password Manager • ThinkVantage System Update • Lenovo Message Center Plus • Adobe® Reader® 				
Environment	ENERGY STAR® 6.1>(*Need 85% PSU and Windows OS); ErP Lot 3; GREENGUARD®; RoHS-compliant; TUV Green Mark						
Accessories	For compatible accessories, please go to TC-AQP sheet						

See footnotes for more detailed information

Model	Region	Processor	vPro	Graphics	Monitor Cable	Memory	Storage	Optical	Optional 2nd 2.5" Bay	Media Reader	WLAN + Bluetooth	Optional Front Ports	Optional Rear Ports	Chassis Intrusion Switch	Cable Lock	PCI Slot	Dust Filter	Keyboard / Mouse	Stand	Power Supply	Operating System	Warranty	Ann Date (m/y)
10FY0004US	US	i7-6700	No	Intel HD 530	None	8GBx1	192GB SSD	DVD±RW	None	None	None	None	PS/2	None	None	None	None	USB / USB	Floor Stand	210W 85%	Win10 DG Win7 Pro 64	3-year, Onsite	11/15
10FY0005US	US	i5-6500	No	Intel HD 530	None	4GBx1	192GB SSD	DVD±RW	None	None	None	None	PS/2	None	None	None	None	USB / USB	Floor Stand	210W 85%	Win10 DG Win7 Pro 64	3-year, Onsite	11/15
10FY0006US	US	i5-6500	No	Intel HD 530	None	4GBx1	500GB 7200rpm 3.5"	DVD±RW	None	None	None	None	PS/2	None	None	None	None	USB / USB	Floor Stand	210W 85%	Win10 DG Win7 Pro 64	3-year, Onsite	11/15
10FY0007US	US	i7-6700	No	Intel HD 530	None	4GBx1	500GB 7200rpm 3.5"	DVD±RW	None	None	None	None	PS/2	None	None	None	None	USB / USB	Floor Stand	210W 85%	Win10 DG Win7 Pro 64	3-year, Onsite	11/15
10FY0008US	US	i7-6700	No	GT 720 1GB	None	8GBx1	1TB 7200rpm 3.5"	DVD±RW	None	None	None	None	PS/2	None	None	None	None	USB / USB	Floor Stand	210W 85%	Win10 DG Win7 Pro 64	3-year, Onsite	11/15
10FY0009US	US	i5-6500	No	Intel HD 530	None	4GBx1	1TB 7200rpm 3.5"	DVD±RW	None	None	None	None	PS/2	None	None	None	None	USB / USB	Floor Stand	210W 85%	Win10 DG Win7 Pro 64	3-year, Onsite	11/15
10FY000AUS	US	i7-6700	No	Intel HD 530	None	8GBx1	1TB 7200rpm 3.5"	DVD±RW	None	None	None	None	PS/2	None	None	None	None	USB / USB	Floor Stand	210W 85%	Win10 DG Win7 Pro 64	3-year, Onsite	11/15
10FY000CUS	US	i7-6700	No	Intel HD 530	None	8GBx1	1TB 7200rpm 3.5"	DVD±RW	None	None	None	None	PS/2	None	None	None	None	USB / USB	Floor Stand	210W 85%	Win10 Pro 64	3-year, Onsite	11/15
10FY000DUS	US	i5-6400	No	Intel HD 530	None	4GBx1	500GB 7200rpm 3.5"	DVD±RW	None	None	None	None	None	None	None	None	None	USB / USB	Floor Stand	210W 85%	Win10 Pro 64	3-year, Onsite	11/15
10FY000EUS	US	i7-6700	No	GT 720 1GB	None	8GBx1	1TB 7200rpm 3.5"	DVD±RW	None	None	None	None	None	None	None	None	None	USB / USB	Floor Stand	210W 85%	Win10 Pro 64	3-year, Onsite	11/15
10FY000FUS	US	i5-6500	No	Intel HD 530	None	4GBx1	500GB 7200rpm 3.5"	DVD±RW	None	None	None	None	None	None	None	None	None	USB / USB	Floor Stand	210W 85%	Win10 Pro 64	3-year, Onsite	11/15
10FY000QUS	US	i3-6100	No	Intel HD 530	None	4GBx1	500GB 7200rpm 3.5"	DVD±RW	Optional 2nd 2.5" Bay	None	None	None	None	None	None	None	None	USB / USB	Floor Stand	210W 85%	Win10 DG Win7 Pro 64	3-year, Onsite	12/15
10FY0012US	US	i3-6100	No	Intel HD 530	None	4GBx1	500GB 7200rpm 3.5"	DVD±RW	None	None	None	None	None	None	None	None	None	USB / USB	Floor Stand	210W 85%	Win10 DG Win7 Pro 64	3-year, Onsite	12/15
10FY0013US	US	i5-6400	No	Intel HD 530	None	4GBx1	500GB 7200rpm 3.5"	DVD±RW	Optional 2nd 2.5" Bay	None	None	None	None	None	None	None	None	USB / USB	Floor Stand	210W 85%	Win10 DG Win7 Pro 64	3-year, Onsite	12/15
10FY0014US	US	i5-6400	No	Intel HD 530	None	8GBx1	180GB SSD Opal	DVD±RW	Optional 2nd 2.5" Bay	None	None	None	None	None	None	None	None	USB / USB	Floor Stand	210W 85%	Win10 DG Win7 Pro 64	3-year, Onsite	12/15
10FY0015US	US	i7-6700	No	Intel HD 530	None	8GBx1	256GB SSD Opal	DVD±RW	Optional 2nd 2.5" Bay	None	None	None	None	None	None	None	None	USB / USB	Floor Stand	210W 85%	Win10 DG Win7 Pro 64	3-year, Onsite	12/15
10FY0016US	US	i7-6700	No	GT 720 1GB	None	8GBx1	1TB 7200rpm 3.5"	DVD±RW	Optional 2nd 2.5" Bay	None	None	None	None	None	None	None	None	USB / USB	Floor Stand	210W 85%	Win10 DG Win7 Pro 64	3-year, Onsite	12/15
10FY0017US	US	i7-6700	No	Intel HD 530	None	8GBx1	1TB 7200rpm 3.5"	DVD±RW	Optional 2nd 2.5" Bay	None	None	None	None	None	None	None	None	USB / USB	Floor Stand	210W 85%	Win10 DG Win7 Pro 64	3-year, Onsite	12/15
10FY0018US	US	i5-6400	No	Intel HD 530	None	8GBx1	1TB 7200rpm 3.5"	DVD±RW	Optional 2nd 2.5" Bay	None	None	None	None	None	None	None	None	USB / USB	Floor Stand	210W 85%	Win10 DG Win7 Pro 64	3-year, Onsite	12/15
10FY0019US	US	i7-6700	No	Intel HD 530	None	8GBx1	1TB 7200rpm 3.5"	DVD±RW	Optional 2nd 2.5" Bay	None	None	None	None	None	None	None	None	USB / USB	Floor Stand	210W 85%	Win10 Pro 64	3-year, Onsite	12/15

Model	Region	Processor	vPro	Graphics	Monitor Cable	Memory	Storage	Optical	Optional 2nd 2.5" Bay	Media Reader	WLAN + Bluetooth	Optional Front Ports	Optional Rear Ports	Chassis Intrusion Switch	Cable Lock	PCI Slot	Dust Filter	Keyboard / Mouse	Stand	Power Supply	Operating System	Warranty	Ann Date (m/y)
10FY001AUS	US	i7-6700	No	Intel HD 530	None	8GBx1	128GB SSD	DVD±RW	Optional 2nd 2.5" Bay	None	None	None	None	None	None	None	None	USB / USB	Floor Stand	210W 85%	Win10 DG Win7 Pro 64	3-year, Onsite	12/15
10FY001BUS	US	i5-6400	No	Intel HD 530	None	8GBx1	128GB SSD	DVD±RW	Optional 2nd 2.5" Bay	None	None	None	None	None	None	None	None	USB / USB	Floor Stand	210W 85%	Win10 DG Win7 Pro 64	3-year, Onsite	12/15
10FY001DUS	US	i5-6400	No	Intel HD 530	None	8GBx1	256GB SSD Opal	DVD±RW	Optional 2nd 2.5" Bay	None	None	None	None	None	None	None	None	USB / USB	Floor Stand	210W 85%	Win10 DG Win7 Pro 64	3-year, Onsite	12/15
10FY001EUS	US	i7-6700	No	GT 720 1GB	None	8GBx1	1TB 7200rpm 3.5"	DVD±RW	Optional 2nd 2.5" Bay	None	None	None	None	None	None	None	None	USB / USB	Floor Stand	210W 85%	Win10 Pro 64	3-year, Onsite	12/15
10FY001FUS	US	i5-6400	No	Intel HD 530	None	4GBx1	500GB 7200rpm 3.5"	DVD±RW	Optional 2nd 2.5" Bay	None	None	None	None	None	None	None	None	USB / USB	Floor Stand	210W 85%	Win10 Pro 64	3-year, Onsite	12/15
10FY001GUS	US	i7-6700	No	GT 720 1GB	None	8GBx2	1TB 7200rpm 3.5"	DVD±RW	Optional 2nd 2.5" Bay	None	None	None	None	None	None	None	None	USB / USB	Floor Stand	210W 85%	Win10 DG Win7 Pro 64	3-year, Onsite	12/15
10FY001HUS	US	i5-6400	No	Intel HD 530	None	8GBx1	500GB 7200rpm 3.5"	DVD±RW	Optional 2nd 2.5" Bay	None	None	None	None	None	None	None	None	USB / USB	Floor Stand	210W 85%	Win10 Pro 64	3-year, Onsite	12/15
10FY001JUS	US	i7-6700	No	GT 720 1GB	None	8GBx2	1TB 7200rpm 3.5"	DVD±RW	Optional 2nd 2.5" Bay	None	None	None	None	None	None	None	None	USB / USB	Floor Stand	210W 85%	Win10 Pro 64	3-year, Onsite	12/15
10FY001KUS	US	i3-6100	No	Intel HD 530	None	4GBx1	128GB SSD	DVD±RW	Optional 2nd 2.5" Bay	None	None	None	None	None	None	None	None	USB / USB	Floor Stand	210W 85%	Win10 DG Win7 Pro 64	3-year, Onsite	12/15
10FY001LUS	US	i3-6100	No	Intel HD 530	None	4GBx1	128GB SSD	DVD±RW	Optional 2nd 2.5" Bay	None	8260 ac, 2x2 + BT4.1	None	None	None	None	None	None	USB / USB	Floor Stand	210W 85%	Win10 Pro 64	3-year, Onsite	12/15
10FY001MUS	US	i3-6100	No	Intel HD 530	None	8GBx1	1TB 7200rpm 3.5"	DVD±RW	Optional 2nd 2.5" Bay	None	None	None	None	None	None	None	None	USB / USB	Floor Stand	210W 85%	Win10 DG Win7 Pro 64	3-year, Onsite	12/15
10FY001NUS	US	i3-6100	No	Intel HD 530	None	4GBx1	500GB 7200rpm 3.5"	DVD±RW	Optional 2nd 2.5" Bay	None	8260 ac, 2x2 + BT4.1	None	None	None	None	None	None	USB / USB	Floor Stand	210W 85%	Win10 DG Win7 Pro 64	3-year, Onsite	12/15
10FY001PUS	US	i3-6100	No	Intel HD 530	None	4GBx1	500GB 7200rpm 3.5"	DVD±RW	Optional 2nd 2.5" Bay	None	8260 ac, 2x2 + BT4.1	None	None	None	None	None	None	USB / USB	Floor Stand	210W 85%	Win10 Pro 64	3-year, Onsite	12/15
10FY0029US	US	i5-6400	No	Intel HD 530	None	8GBx1	1TB 7200rpm 3.5"	DVD±RW	Optional 2nd 2.5" Bay	None	None	None	None	None	None	None	None	USB / USB	Floor Stand	210W 85%	Win10 Pro 64	3-year, Onsite	10/16
10FY002GUS	US	i3-6100	No	Intel HD 530	None	4GBx1	500GB 7200rpm 2.5"	DVD±RW	Optional 2nd 2.5" Bay	None	None	None	None	None	None	None	None	USB / USB	Floor Stand	210W 85%	Win10 Pro 64	3-year, Onsite	07/16
10FY003BUS	US	i7-6700	No	GT 720 1GB	None	8GBx1	1TB 7200rpm 3.5"	DVD±RW	Optional 2nd 2.5" Bay	None	None	None	None	None	None	None	None	USB / USB	Floor Stand	210W 85%	Win10 DG Win7 Pro 64	3-year, Onsite	10/16
10FY003CUS	US	i7-6700	No	GT 720 1GB	None	8GBx2	1TB 7200rpm 3.5"	DVD±RW	Optional 2nd 2.5" Bay	None	None	None	None	None	None	None	None	USB / USB	Floor Stand	210W 85%	Win10 DG Win7 Pro 64	3-year, Onsite	10/16
10FY003DUS	US	i7-6700	No	GT 720 1GB	None	8GBx1	1TB 7200rpm 3.5"	DVD±RW	Optional 2nd 2.5" Bay	None	None	None	None	None	None	None	None	USB / USB	Floor Stand	210W 85%	Win10 Pro 64	3-year, Onsite	10/16
10FY003EUS	US	i7-6700	No	GT 720 1GB	None	8GBx2	1TB 7200rpm 3.5"	DVD±RW	Optional 2nd 2.5" Bay	None	None	None	None	None	None	None	None	USB / USB	Floor Stand	210W 85%	Win10 Pro 64	3-year, Onsite	10/16

Model	Region	Processor	vPro	Graphics	Monitor Cable	Memory	Storage	Optical	Optional 2nd 2.5" Bay	Media Reader	WLAN + Bluetooth	Optional Front Ports	Optional Rear Ports	Chassis Intrusion Switch	Cable Lock	PCI Slot	Dust Filter	Keyboard / Mouse	Stand	Power Supply	Operating System	Warranty	Ann Date (m/y)
10FX0005US	US	i5-6500	No	Intel HD 530	None	4GBx1	500GB 7200rpm 3.5"	DVD±RW	None	None	None	None	PS/2	None	None	None	None	USB / USB	Floor Stand	210W 85%	Win10 DG Win7 Pro 64	3-year, Onsite	11/15
10FX0006US	US	i7-6700	No	GT 720 1GB	None	8GBx1	1TB 7200rpm 3.5"	DVD±RW	None	None	None	None	PS/2	None	None	None	None	USB / USB	Floor Stand	210W 85%	Win10 DG Win7 Pro 64	3-year, Onsite	11/15
10FX0007US	US	i7-6700	No	Intel HD 530	None	8GBx1	120GB SSD	DVD±RW	None	None	None	None	PS/2	None	None	None	None	USB / USB	Floor Stand	210W 85%	Win10 DG Win7 Pro 64	3-year, Onsite	11/15
10FX0008US	US	i7-6700	No	Intel HD 530	None	4GBx1	500GB 7200rpm 3.5"	DVD±RW	None	None	None	None	PS/2	None	None	None	None	USB / USB	Floor Stand	210W 85%	Win10 DG Win7 Pro 64	3-year, Onsite	11/15
10FX0009US	US	i7-6700	No	Intel HD 530	None	8GBx1	1TB 7200rpm 3.5"	DVD±RW	None	None	None	None	PS/2	None	None	None	None	USB / USB	Floor Stand	210W 85%	Win10 DG Win7 Pro 64	3-year, Onsite	11/15
10FX000VUS	US	i5-6500	No	Intel HD 530	DP to HDMI	4GBx1	500GB 7200rpm 3.5"	DVD±RW	None	None	None	None	None	None	None	None	None	USB / USB	None	210W 85%	Win10 Pro 64	3-year, Onsite, OID	11/15
10FX0011US	US	i5-6500	No	GT 720 1GB	DP to VGA	4GBx1	1TB 7200rpm 3.5"	DVD±RW	None	9-in-1	None	None	None	None	None	None	None	USB / USB	None	210W 85%	Win10 Pro 64	3-year, Onsite, OID	11/15
10FX0012US	US	i5-6500	No	Intel HD 530	None	4GBx1	500GB 7200rpm 3.5"	DVD	None	None	None	None	None	None	None	None	None	USB / USB	None	210W 85%	Win10 DG Win7 Pro 64	3-year, Onsite, OID	11/15
10FX0013US	US	i5-6500	No	GT 720 1GB	None	4GBx1	1TB 7200rpm 3.5"	DVD±RW	None	9-in-1	None	None	None	None	None	None	Dust Filter	USB / USB	None	210W 85%	Win10 DG Win7 Pro 64	3-year, Onsite, OID	11/15
10FX0014US	US	i5-6500	No	Intel HD 530	None	4GBx1	500GB 7200rpm 3.5"	DVD±RW	None	None	None	None	None	None	None	None	None	USB / USB	None	210W 85%	Win10 DG Win7 Pro 64	3-year, Onsite, OID	11/15



ThinkCentre M800 Tower Platform Specifications

Product Specifications Reference (PSREF)

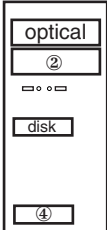
Processor	Intel® Celeron®, Intel Pentium®, or 6th Generation Intel Core™ i3 / i5 / i7 Processor	Manageability	Intel Standard Manageability																																																						
	<table border="1"> <thead> <tr> <th>Processor</th> <th>Cores / Threads</th> <th>Frequency Base/Max(GHz)</th> <th>Cache</th> <th>Memory Types</th> <th>Integrated Graphics</th> </tr> </thead> <tbody> <tr> <td>Pentium G4400</td> <td>2 / 2</td> <td>3.3G</td> <td>3 MB</td> <td>DDR4-2133</td> <td>HD 510</td> </tr> <tr> <td>Pentium G4500</td> <td>2 / 2</td> <td>3.5G</td> <td>3 MB</td> <td>DDR4-2133</td> <td>HD 530</td> </tr> <tr> <td>Core i3-6100</td> <td>2 / 4</td> <td>3.7 G</td> <td>3 MB</td> <td>DDR4-2133</td> <td>HD 530</td> </tr> <tr> <td>Core i3-6300</td> <td>2 / 4</td> <td>3.8 G</td> <td>4 MB</td> <td>DDR4-2133</td> <td>HD 530</td> </tr> <tr> <td>Core i5-6400</td> <td>4 / 4</td> <td>2.7 G / 3.3 G</td> <td>6 MB</td> <td>DDR4-2133</td> <td>HD 530</td> </tr> <tr> <td>Core i5-6500</td> <td>4 / 4</td> <td>3.2 G / 3.6 G</td> <td>6 MB</td> <td>DDR4-2133</td> <td>HD 530</td> </tr> <tr> <td>Core i5-6600</td> <td>4 / 4</td> <td>3.3 G / 3.9 G</td> <td>6 MB</td> <td>DDR4-2133</td> <td>HD 530</td> </tr> <tr> <td>Core i7-6700</td> <td>4 / 8</td> <td>3.4 G / 4.0 G</td> <td>8 MB</td> <td>DDR4-2133</td> <td>HD 530</td> </tr> </tbody> </table>	Processor	Cores / Threads	Frequency Base/Max(GHz)	Cache	Memory Types	Integrated Graphics	Pentium G4400	2 / 2	3.3G	3 MB	DDR4-2133	HD 510	Pentium G4500	2 / 2	3.5G	3 MB	DDR4-2133	HD 530	Core i3-6100	2 / 4	3.7 G	3 MB	DDR4-2133	HD 530	Core i3-6300	2 / 4	3.8 G	4 MB	DDR4-2133	HD 530	Core i5-6400	4 / 4	2.7 G / 3.3 G	6 MB	DDR4-2133	HD 530	Core i5-6500	4 / 4	3.2 G / 3.6 G	6 MB	DDR4-2133	HD 530	Core i5-6600	4 / 4	3.3 G / 3.9 G	6 MB	DDR4-2133	HD 530	Core i7-6700	4 / 8	3.4 G / 4.0 G	8 MB	DDR4-2133	HD 530	Security chip	Trusted Platform Module, TCG 1.2-compliant
Processor	Cores / Threads	Frequency Base/Max(GHz)	Cache	Memory Types	Integrated Graphics																																																				
Pentium G4400	2 / 2	3.3G	3 MB	DDR4-2133	HD 510																																																				
Pentium G4500	2 / 2	3.5G	3 MB	DDR4-2133	HD 530																																																				
Core i3-6100	2 / 4	3.7 G	3 MB	DDR4-2133	HD 530																																																				
Core i3-6300	2 / 4	3.8 G	4 MB	DDR4-2133	HD 530																																																				
Core i5-6400	4 / 4	2.7 G / 3.3 G	6 MB	DDR4-2133	HD 530																																																				
Core i5-6500	4 / 4	3.2 G / 3.6 G	6 MB	DDR4-2133	HD 530																																																				
Core i5-6600	4 / 4	3.3 G / 3.9 G	6 MB	DDR4-2133	HD 530																																																				
Core i7-6700	4 / 8	3.4 G / 4.0 G	8 MB	DDR4-2133	HD 530																																																				
		Security features	<ul style="list-style-type: none"> One lock to secure both cover and entire system to fixed object: <ul style="list-style-type: none"> -Padlock loop (in rear for opt padlock) -Security slot (in rear for optional Kensington® MicroSaver® cable) Power-on password Administrator password Hard disk password Boot sequence control Boot without keyboard and mouse Individual USB port disablement Optional chassis intrusion switch 																																																						
		Keyboard	<i>Some:</i> Preferred Pro USB Keyboard (USB connector), Lenovo logo <i>Some:</i> Lenovo USB Fingerprint Keyboard (USB connector) <i>Some:</i> Ultralim Plus Wireless Keyboard (2.4GHz via USB receiver), black																																																						
		Mouse	<i>Some:</i> Enhanced Optical USB Mouse, black, Lenovo logo <i>Some:</i> Ultralim Plus Wireless Mouse (2.4GHz via USB receiver), black																																																						
Memory	64GB max, UDIMM, DDR4 2133, four 288-pin DIMM sockets, dual-channel capable	Mechanical	<ul style="list-style-type: none"> Tower (25L), black color, metal case (WxDxH) 6.89" X 16.26" X 15.98"; 175mm X 413mm X 406mm 27.56 lb (12.5 kg) Toolless cover, disk, optical removal Toolless graphics, PCI adapter retention Optional dust filter Bay 1: 5.25", 1.6" high, access, std optical Bay 2: 5.25", 1.6" high, access, opt media reader / front access HDD Bay 3: 3.5", 1" high, no access, std disk Bay 4: 3.5", 1" high, no access, opt disk (optional 2nd 3.5" disk tray) Slot 1: half-length, full-height, PCIe 3.0 x16 (75w max) Slot 2: half-length, full-height, PCIe 3.0 x1 Slot 3: half-length, full-height, PCIe 3.0 x16 (x4 elec, 75w max) Slot 4: half-length, full-height, optional 32-bit PCI 2.3 (via M.2 to PCI adaptor) 																																																						
Disk	<i>Some:</i> Hard disk, SATA 6.0Gb/s, 2.5"/ 3.5" wide, 5400 / 7200 rpm <i>Some:</i> Solid State Hybrid Drive (SSHD), 500GB (5400 rpm, 2.5") / 1TB or 2TB (7200 rpm, 3.5"), with 8GB NAND flash memory, SATA 6.0Gb/s <i>Some:</i> Solid State Drive (SSD) / SATA 6.0Gb/s, 2.5" Wide <i>Some:</i> Front accessible and removable HDD, 3.5", lockable via physical key																																																								
Optical	<i>Some:</i> DVD-ROM SATA 1.5Gb/s Drive <i>Some:</i> Super Multi-Burner DVD±RW SATA 1.5Gb/s Drive																																																								
Onboard SATA	Four onboard SATA 6.0Gb/s connectors, one is eSATA connector for optional rear eSATA port																																																								
Media reader	Optional 29-in-1 media reader																																																								
Graphics	Intel HD Graphics 510/530 in processor, uses main memory, DirectX® 12, one VGA, two DisplayPort™, supports three independent displays, works along with discrete graphics to support more displays; <i>Max resolution:</i> 4096x2304 (DP)@60Hz; 1920x1200 (VGA)@60Hz <i>Some:</i> NVIDIA® Quadro® K420 , DirectX 12, 2GB, PCIe 2.0 x16 adapter, one DVI-I, one DisplayPort, 41 watts; <i>Max resolution:</i> 3840x2160 (DisplayPort)@60Hz; 2560x1600 (DVI-I)@60Hz <i>Some:</i> NVIDIA GeForce® GT 720 , DirectX 12, 2GB, PCIe 2.0 x8 adapter, one VGA, one HDMI, 25 watts; <i>Max resolution:</i> 1920x1080 (HDMI)@60Hz; 2048x1536 (VGA)@85Hz <i>Some:</i> NVIDIA GeForce GT 720 , DirectX 12, 1GB, PCIe 2.0 x8 adapter, two DisplayPort, 25 watts; <i>Max resolution:</i> 3840x2160 (DisplayPort)@60Hz; Optional DP to VGA, DP to DVI-D (single link), or DP to HDMI 1.4 dongle																																																								
Power supply	250 watts, autosensing, 85% PSU																																																								
DP cable	Optional DP to VGA, DP to DVI-D (single link), or DP to HDMI 1.4 dongle	Limited warranty ³	<i>Some:</i> 1-year or 3-year, limited onsite service / service upgrades available <i>Some:</i> 3-year, limited onsite service, OID (Onsite International Delivery) / service upgrades available For Lenovo service upgrade options, please go to S-TC sheet																																																						
Chipset	Intel Q150 Chipset	Preload	Preloaded operating system <i>Some:</i> Windows® 7 Professional 64 preinstalled through downgrade rights in Windows 10 Pro 64-bit <i>Some:</i> Windows 7 Professional 64 <i>Some:</i> Windows 10 Pro 64-bit <i>Some:</i> Windows 10 Home 64-bit Preloaded applications (only some listed) <ul style="list-style-type: none"> Desktop Power Manager Lenovo Solution Center Lenovo REACHit Lenovo SHAREit Lenovo Bluetooth Lock (for models with Wi-Fi/BT card) McAfee® LiveSafe™ (30-day trial) Microsoft Office preloaded; purchase a product key to activate PowerDVD Create (DVD±RW) Lenovo ThinkVantage Tools - Only for Window 10 <ul style="list-style-type: none"> Lenovo Companion Cyberlink PowerDVD (DVD, DVD±RW) Lenovo QuickOptimizer - Only for Window 7 <ul style="list-style-type: none"> Rescue and Recovery Password Manager ThinkVantage System Update Lenovo Message Center Plus Adobe® Reader® 																																																						
Front ports	Two USB 3.0, two optional USB 2.0, microphone (3.5mm), headphone (3.5mm)	Environment	ENERGY STAR® 6.1*(Need 85% PSU and Windows OS); ErP Lot 3; GREENGUARD®; RoHS-compliant; TUV Green Mark																																																						
Rear ports	Four USB 3.0, two USB 2.0, two optional USB 2.0, serial (9-pin), optional 2nd serial (9-pin), optional parallel (25-pin), ethernet (RJ-45), one VGA, two DisplayPort, optional PS/2 ports (keyboard/mouse), one optional eSATA port additional VGA, DisplayPort, DVI-I or HDMI on optional graphics on some models	Accessories	For compatible accessories, please go to TC-AQP sheet																																																						
Rear audio ports	Line-in (3.5mm), line-out (3.5mm), microphone-in (3.5mm)																																																								
IEEE 1394	None																																																								
Audio support	High Definition (HD) Audio, Realtek ALC662 / optional internal speaker (1.5 watt)																																																								
WLAN ¹³	<i>Some:</i> 11ac wireless, M.2 Card, Qualcomm Atheros QCA9377 (dual band), Wi-Fi + Bluetooth 4.1 combo adapter, 1x1 <i>Some:</i> 11ac wireless, M.2 Card, Qualcomm Atheros QCA6174 (dual band), Wi-Fi + Bluetooth 4.1 combo adapter, 2x2 <i>Some:</i> 11ac wireless, M.2 Card, Intel Dual Band Wireless-AC 3165, Wi-Fi + Bluetooth 4.0 combo adapter, 1x1 <i>Some:</i> 11ac wireless, M.2 Card, Intel Dual Band Wireless-AC 8260, Wi-Fi + Bluetooth 4.1 combo adapter, 2x2																																																								
Bluetooth™	<i>Some:</i> Bluetooth 4.0 or 4.1 wireless, integrated in Wi-Fi + BT combo adapter																																																								
Ethernet	Gigabit ethernet, Intel Ethernet Connection I219-LM (Jacksonville), Wake on LAN®																																																								
Modem	None																																																								

See footnotes for more detailed information

Model	Region	Processor	vPro	Graphics	Monitor Cable	Memory	Storage	Optical	Optional 2nd 3.5" Tray	Media Reader	WLAN + Bluetooth	Optional Front Ports	Optional Rear Ports	Chassis Intrusion Switch	Cable Lock	Front Access HDD	PCI Slot	Dust Filter	Keyboard / Mouse	Carry Handle	Power Supply	Operating System	Warranty	Ann Date (m/y)	
10FW0002US	US	i7-6700	No	Intel HD 530	None	4GBx1	1TB 7200rpm 3.5"	DVD±RW	None	None	None	None	None	None	None	None	None	None	None	USB / USB	Carry Handle	250W 85%	Win10 DG Win7 Pro 64	3-year, Onsite	11/15
10FW0003US	US	i7-6700	No	K420 2GB	None	8GBx1	1TB 7200rpm 3.5"	DVD±RW	None	None	None	None	None	None	None	None	None	None	None	USB / USB	Carry Handle	250W 85%	Win10 DG Win7 Pro 64	3-year, Onsite	11/15
10FW0004US	US	i7-6700	No	Intel HD 530	None	8GBx1	120GB SSD	DVD±RW	None	None	None	None	None	None	None	None	None	None	None	USB / USB	Carry Handle	250W 85%	Win10 DG Win7 Pro 64	3-year, Onsite	11/15
10FW0005US	US	i5-6500	No	Intel HD 530	None	4GBx1	500GB 7200rpm 3.5"	DVD±RW	None	None	None	None	None	None	None	None	None	None	None	USB / USB	Carry Handle	250W 85%	Win10 DG Win7 Pro 64	3-year, Onsite	11/15
10FW0006US	US	i7-6700	No	Intel HD 530	None	8GBx1	500GB 7200rpm 3.5"	DVD±RW	None	None	None	None	None	None	None	None	None	None	None	USB / USB	Carry Handle	250W 85%	Win10 DG Win7 Pro 64	3-year, Onsite	11/15
10FW0007US	US	i5-6500	No	Intel HD 530	None	4GBx1	120GB SSD	DVD±RW	None	None	None	None	None	None	None	None	None	None	None	USB / USB	Carry Handle	250W 85%	Win10 DG Win7 Pro 64	3-year, Onsite	11/15
10FW000WUS	US	i5-6400	No	Intel HD 530	None	4GBx1	500GB 7200rpm 3.5"	DVD±RW	None	None	None	None	None	None	None	None	None	None	None	USB / USB	Carry Handle	250W 85%	Win10 Pro 64	3-year, Onsite	11/15
10FW000XUS	US	i7-6700	No	GT 720 1GB	None	8GBx1	1TB 7200rpm 3.5"	DVD±RW	None	None	None	None	None	None	None	None	None	None	None	USB / USB	Carry Handle	250W 85%	Win10 Pro 64	3-year, Onsite	11/15
10FW000YUS	US	i7-6700	No	Intel HD 530	None	8GBx1	1TB 7200rpm 3.5"	DVD±RW	None	None	None	None	None	None	None	None	None	None	None	USB / USB	Carry Handle	250W 85%	Win10 Pro 64	3-year, Onsite	11/15
10FW0010US	US	i5-6500	No	Intel HD 530	None	4GBx1	500GB 7200rpm 3.5"	DVD±RW	None	None	None	None	None	None	None	None	None	None	None	USB / USB	Carry Handle	250W 85%	Win10 Pro 64	3-year, Onsite	11/15
10FW001NUS	US	i7-6700	No	Intel HD 530	None	8GBx1	1TB 7200rpm 3.5"	DVD±RW	Optional 2nd 3.5" Tray	None	None	None	None	None	None	None	None	None	None	USB / USB	Carry Handle	250W 85%	Win10 Pro 64	3-year, Onsite	12/15
10FW001PUS	US	i5-6400	No	Intel HD 530	None	8GBx1	500GB 7200rpm 3.5"	DVD±RW	Optional 2nd 3.5" Tray	None	None	None	None	None	None	None	None	None	None	USB / USB	Carry Handle	250W 85%	Win10 Pro 64	3-year, Onsite	12/15
10FW001QUS	US	i7-6700	No	GT 720 1GB	None	8GBx2	1TB 7200rpm 3.5"	DVD±RW	Optional 2nd 3.5" Tray	None	None	None	None	None	None	None	None	None	None	USB / USB	Carry Handle	250W 85%	Win10 Pro 64	3-year, Onsite	12/15
10FW001RUS	US	i7-6700	No	GT 720 1GB	None	8GBx1	1TB 7200rpm 3.5"	DVD±RW	Optional 2nd 3.5" Tray	None	None	None	None	None	None	None	None	None	None	USB / USB	Carry Handle	250W 85%	Win10 Pro 64	3-year, Onsite	12/15
10FW001SUS	US	i5-6400	No	Intel HD 530	None	4GBx1	500GB 7200rpm 3.5"	DVD±RW	Optional 2nd 3.5" Tray	None	None	None	None	None	None	None	None	None	None	USB / USB	Carry Handle	250W 85%	Win10 Pro 64	3-year, Onsite	12/15
10FW001TUS	US	i3-6100	No	Intel HD 530	None	4GBx1	500GB 7200rpm 3.5"	DVD±RW	Optional 2nd 3.5" Tray	None	8260 ac, 2x2 + BT4.1	None	None	None	None	None	None	None	None	USB / USB	Carry Handle	250W 85%	Win10 Pro 64	3-year, Onsite	12/15
10FW001UUS	US	i3-6100	No	Intel HD 530	None	4GBx1	500GB 7200rpm 3.5"	DVD±RW	Optional 2nd 3.5" Tray	None	None	None	None	None	None	None	None	None	None	USB / USB	Carry Handle	250W 85%	Win10 DG Win7 Pro 64	3-year, Onsite	12/15
10FW001VUS	US	i3-6100	No	Intel HD 530	None	4GBx1	128GB SSD	DVD±RW	Optional 2nd 3.5" Tray	None	8260 ac, 2x2 + BT4.1	None	None	None	None	None	None	None	None	USB / USB	Carry Handle	250W 85%	Win10 Pro 64	3-year, Onsite	12/15
10FW001WUS	US	i3-6100	No	Intel HD 530	None	4GBx1	500GB 7200rpm 3.5"	DVD±RW	Optional 2nd 3.5" Tray	None	8260 ac, 2x2 + BT4.1	None	None	None	None	None	None	None	None	USB / USB	Carry Handle	250W 85%	Win10 DG Win7 Pro 64	3-year, Onsite	12/15
10FW001XUS	US	i3-6100	No	Intel HD 530	None	8GBx1	1TB 7200rpm 3.5"	DVD±RW	Optional 2nd 3.5" Tray	None	None	None	None	None	None	None	None	None	None	USB / USB	Carry Handle	250W 85%	Win10 DG Win7 Pro 64	3-year, Onsite	12/15

Model	Region	Processor	vPro	Graphics	Monitor Cable	Memory	Storage	Optical	Optional 2nd 3.5" Tray	Media Reader	WLAN + Bluetooth	Optional Front Ports	Optional Rear Ports	Chassis Intrusion Switch	Cable Lock	Front Access HDD	PCI Slot	Dust Filter	Keyboard / Mouse	Carry Handle	Power Supply	Operating System	Warranty	Ann Date (m/y)
10FW001YUS	US	i3-6100	No	Intel HD 530	None	4GBx1	128GB SSD	DVD±RW	Optional 2nd 3.5" Tray	None	None	None	None	None	None	None	None	None	USB / USB	Carry Handle	250W 85%	Win10 DG Win7 Pro 64	3-year, Onsite	12/15
10FW002TUS	US	i3-6100	No	Intel HD 530	None	4GBx1	500GB 7200rpm 3.5"	DVD±RW	Optional 2nd 3.5" Tray	None	None	None	None	None	None	None	None	None	USB / USB	Carry Handle	250W 85%	Win10 Pro 64	3-year, Onsite	07/16
10FW002UUS	US	i7-6700	No	Intel HD 530	None	8GBx1	128GB SSD	DVD±RW	Optional 2nd 3.5" Tray	None	None	None	None	None	None	None	None	None	USB / USB	Carry Handle	250W 85%	Win10 Pro 64	3-year, Onsite	07/16
10FW003DUS	US	i7-6700	No	GT 720 1GB	None	8GBx2	1TB 7200rpm 3.5"	DVD±RW	Optional 2nd 3.5" Tray	None	None	None	None	None	None	None	None	None	USB / USB	Carry Handle	250W 85%	Win10 Pro 64	3-year, Onsite	10/16
10FW003EUS	US	i7-6700	No	GT 720 1GB	None	8GBx2	1TB 7200rpm 3.5"	DVD±RW	Optional 2nd 3.5" Tray	None	None	None	None	None	None	None	None	None	USB / USB	Carry Handle	250W 85%	Win10 DG Win7 Pro 64	3-year, Onsite	10/16
10FW003FUS	US	i7-6700	No	GT 720 1GB	None	8GBx1	1TB 7200rpm 3.5"	DVD±RW	Optional 2nd 3.5" Tray	None	None	None	None	None	None	None	None	None	USB / USB	Carry Handle	250W 85%	Win10 DG Win7 Pro 64	3-year, Onsite	10/16
10FW003GUS	US	i7-6700	No	GT 720 1GB	None	8GBx1	1TB 7200rpm 3.5"	DVD±RW	Optional 2nd 3.5" Tray	None	None	None	None	None	None	None	None	None	USB / USB	Carry Handle	250W 85%	Win10 Pro 64	3-year, Onsite	10/16

Model	Region	Processor	vPro	Graphics	Monitor Cable	Memory	Storage	Optical	Optional 2nd 3.5" Tray	Media Reader	WLAN + Bluetooth	Optional Front Ports	Optional Rear Ports	Chassis Intrusion Switch	Cable Lock	Front Access HDD	PCI Slot	Dust Filter	Keyboard / Mouse	Carry Handle	Power Supply	Operating System	Warranty	Ann Date (m/y)
10FV0004US	US	i7-6700	No	K420 2GB	None	8GBx1	1TB 7200rpm 3.5"	DVD±RW	None	None	None	None	None	None	None	None	None	None	USB / USB	Carry Handle	250W 85%	Win10 DG Win7 Pro 64	3-year, Onsite	11/15
10FV0005US	US	i7-6700	No	Intel HD 530	None	8GBx1	120GB SSD	DVD±RW	None	None	None	None	None	None	None	None	None	None	USB / USB	Carry Handle	250W 85%	Win10 DG Win7 Pro 64	3-year, Onsite	11/15
10FV0006US	US	i7-6700	No	Intel HD 530	None	8GBx1	500GB 7200rpm 3.5"	DVD±RW	None	None	None	None	None	None	None	None	None	None	USB / USB	Carry Handle	250W 85%	Win10 DG Win7 Pro 64	3-year, Onsite	11/15
10FV0007US	US	i5-6500	No	Intel HD 530	None	4GBx1	120GB SSD	DVD±RW	None	None	None	None	None	None	None	None	None	None	USB / USB	Carry Handle	250W 85%	Win10 DG Win7 Pro 64	3-year, Onsite	11/15
10FV0008US	US	i7-6700	No	GT 720 1GB	None	8GBx1	1TB 7200rpm 3.5"	DVD±RW	None	None	None	None	None	None	None	None	None	None	USB / USB	Carry Handle	250W 85%	Win10 DG Win7 Pro 64	3-year, Onsite	11/15
10FV0009US	US	i7-6700	No	Intel HD 530	None	8GBx1	1TB 7200rpm 3.5"	DVD±RW	None	None	None	None	None	None	None	None	None	None	USB / USB	Carry Handle	250W 85%	Win10 DG Win7 Pro 64	3-year, Onsite	11/15
10FV000AUS	US	i5-6500	No	Intel HD 530	None	4GBx1	1TB 7200rpm 3.5"	DVD±RW	None	None	None	None	None	None	None	None	None	None	USB / USB	Carry Handle	250W 85%	Win10 DG Win7 Pro 64	3-year, Onsite	11/15
10FV000BUS	US	i5-6500	No	GT 720 1GB	None	4GBx1	1TB 7200rpm 3.5"	DVD±RW	None	None	None	None	None	None	None	None	None	None	USB / USB	Carry Handle	250W 85%	Win10 DG Win7 Pro 64	3-year, Onsite	11/15
10FV000CUS	US	i5-6500	No	Intel HD 530	None	4GBx1	500GB 7200rpm 3.5"	DVD±RW	None	None	None	None	None	None	None	None	None	None	USB / USB	Carry Handle	250W 85%	Win10 DG Win7 Pro 64	3-year, Onsite	11/15
10FV000MUS	US	i5-6500	No	Intel HD 530	None	4GBx1	500GB 7200rpm 3.5"	DVD	None	None	None	None	None	None	None	None	None	None	USB / USB	None	250W 85%	Win10 Pro 64	3-year, Onsite, OID	11/15
10FV000NUS	US	i5-6500	No	GT 720 1GB	DP to HDMI	4GBx1	1TB 7200rpm 3.5"	DVD±RW	None	29-in-1	None	None	None	None	None	None	None	None	USB / USB	None	250W 85%	Win10 Pro 64	3-year, Onsite, OID	11/15
10FV000PUS	US	i5-6500	No	Intel HD 530	None	4GBx1	500GB 7200rpm 3.5"	None	None	None	None	None	None	None	None	None	None	None	USB / USB	Carry Handle	250W 85%	Win10 Pro 64	3-year, Onsite, OID	11/15
10FV000QUS	US	i5-6500	No	GT 720 1GB	None	4GBx1	1TB 7200rpm 3.5"	DVD±RW	None	29-in-1	None	None	None	None	None	None	None	Dust Filter	USB / USB	Carry Handle	250W 85%	Win10 DG Win7 Pro 64	3-year, Onsite, OID	11/15
10FV000RUS	US	i5-6500	No	Intel HD 530	None	4GBx1	500GB 7200rpm 3.5"	DVD±RW	None	None	None	None	None	None	None	None	None	None	USB / USB	None	250W 85%	Win10 DG Win7 Pro 64	3-year, Onsite, OID	11/15
10FV000SUS	US	i5-6500	No	Intel HD 530	None	4GBx1	500GB 7200rpm 3.5"	DVD	None	None	None	None	None	None	None	None	None	None	USB / USB	None	250W 85%	Win10 DG Win7 Pro 64	3-year, Onsite, OID	11/15



ThinkCentre M900 SFF Platform Specifications

Product Specifications Reference (PSREF)

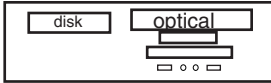
Processor	Intel® Celeron®, Intel Pentium®, or 6th Generation Intel Core™ i3 / i5 / i7 Processor							Manageability Intel Active Management Technology 11.0 (Intel AMT 11.0); Intel vPro technology on some models (require choosing a vPro-support Wi-Fi adapter to enable vPro function through wireless connection)
	Processor	Cores / Threads	Frequency Base/Max(GHz)	Cache	Memory Types	Integrated Graphics	Intel vPro	
	Pentium G4400	2 / 2	3.3G	3 MB	DDR4-2133	HD 510	No	
	Pentium G4500	2 / 2	3.5G	3 MB	DDR4-2133	HD 530	No	
	Core i3-6100	2 / 4	3.7 G	3 MB	DDR4-2133	HD 530	No	
	Core i3-6300	2 / 4	3.8 G	4 MB	DDR4-2133	HD 530	No	
	Core i5-6400	4 / 4	2.7 G / 3.3 G	6 MB	DDR4-2133	HD 530	No	
	Core i5-6500	4 / 4	3.2 G / 3.6 G	6 MB	DDR4-2133	HD 530	vPro	
Core i5-6600	4 / 4	3.3 G / 3.9 G	6 MB	DDR4-2133	HD 530	vPro		
Core i7-6700	4 / 8	3.4 G / 4.0 G	8 MB	DDR4-2133	HD 530	vPro		
Memory	64GB max, UDIMM, DDR4 2133, four 288-pin DIMM sockets, dual-channel capable							Security chip Trusted Platform Module, TCG 1.2-compliant
Disk	<i>Some:</i> Hard disk, SATA 6.0Gb/s, 2.5"/ 3.5" wide, 5400 / 7200 rpm <i>Some:</i> Solid State Hybrid Drive (SSHD), 500GB (5400 rpm, 2.5") / 1TB or 2TB (7200 rpm, 3.5"), with 8GB NAND flash memory, SATA 6.0Gb/s <i>Some:</i> Solid State Drive (SSD) / SATA 6.0Gb/s, 2.5" Wide <i>Some:</i> M.2 SSD, PCIe NVMe, PCIe 3.0 x4, 32Gb/s <i>Some:</i> DVD-ROM SATA 1.5Gb/s Drive <i>Some:</i> Super Multi-Burner DVD±RW SATA 1.5Gb/s Drive							
Optical	Four onboard SATA 6.0Gb/s connectors, one is eSATA connector for optional rear eSATA port, RAID 0, 1 support							Security features <ul style="list-style-type: none"> • One lock to secure both cover and entire system to fixed object: <ul style="list-style-type: none"> -Padlock loop (in rear for opt padlock) -Security slot (in rear for optional Kensington® MicroSaver® cable) • Power-on password • Administrator password • Hard disk password • Boot sequence control • Boot without keyboard and mouse • Individual USB port disablement • Optional chassis intrusion switch
Onboard SATA	Optional 9-in-1 media reader							
Media reader	Optional 9-in-1 media reader							Keyboard <i>Some:</i> Preferred Pro USB Keyboard (USB connector), Lenovo logo <i>Some:</i> Lenovo USB Fingerprint Keyboard (USB connector) <i>Some:</i> Ultralim Plus Wireless Keyboard (2.4GHz via USB receiver), black <i>Some:</i> Enhanced Optical USB Mouse, black, Lenovo logo <i>Some:</i> Ultralim Plus Wireless Mouse (2.4GHz via USB receiver), black
Graphics	Intel HD Graphics 510/530 in processor, uses main memory, DirectX® 12, one VGA, two DisplayPort™, supports three independent displays, works along with discrete graphics to support more displays; <i>Max resolution:</i> 4096x2304 (DP)@60Hz; 1920x1200 (VGA)@60Hz <i>Some:</i> NVIDIA® Quadro® K420 , DirectX 12, 2GB, PCIe 2.0 x16 adapter, one DVI-I, one DisplayPort, 41 watts; <i>Max resolution:</i> 3840x2160 (DisplayPort)@60Hz; 2560x1600 (DVI-I)@60Hz <i>Some:</i> NVIDIA GeForce® GT 720 , DirectX 12, 2GB, PCIe 2.0 x8 adapter, one VGA, one HDMI, 25 watts; <i>Max resolution:</i> 1920x1080 (HDMI)@60Hz; 2048x1536 (VGA)@85Hz <i>Some:</i> NVIDIA GeForce GT 720 , DirectX 12, 1GB, PCIe 2.0 x8 adapter, two DisplayPort, 25 watts; <i>Max resolution:</i> 3840x2160 (DisplayPort)@60Hz;							
DP cable	Optional DP to VGA, DP to DVI-D (single link), or DP to HDMI 1.4 dongle							Mechanical <ul style="list-style-type: none"> • SFF (9.7L), black color; metal case • (WxDxH) 13.31" X 14.05" X 3.46"; 338mm X 357mm X 88mm • 12.3 lb (5.6 kg) • Toolless cover, disk, optical removal • Toolless graphics, PCI adapter retention • Optional dust filter 
Chipset	Intel Q170 Chipset							
Front ports	Two USB 3.0, two optional USB 2.0, microphone (3.5mm), headphone (3.5mm)							Floor Stand Optional system floor stand for vertical orientation
Rear ports	Six USB 3.0, two optional USB 2.0, serial (9-pin), optional 2nd serial (9-pin), optional parallel (25-pin), ethernet (RJ-45), one VGA, two DisplayPort, optional PS/2 ports (keyboard/mouse), one optional eSATA port additional VGA, DisplayPort, DVI-I or HDMI on optional graphics on some models							
Rear audio ports	Line-in (3.5mm), line-out (3.5mm), microphone-in (3.5mm)							Power supply 210 watts, autosensing, 85% PSU
IEEE 1394	None							
Audio support	High Definition (HD) Audio, Realtek ALC662 / optional internal speaker (1.5 watt)							Limited warranty ³ <i>Some:</i> 1-year or 3-year, limited onsite service / service upgrades available <i>Some:</i> 3-year, limited onsite service, OID (Onsite International Delivery) / service upgrades available <i>For Lenovo service upgrade options, please go to S-TC sheet</i>
WLAN ¹³	<i>Some:</i> 11ac wireless, M.2 Card, Qualcomm Atheros QCA9377 (dual band), Wi-Fi + Bluetooth 4.1 combo adapter, 1x1 <i>Some:</i> 11ac wireless, M.2 Card, Qualcomm Atheros QCA6174 (dual band), Wi-Fi + Bluetooth 4.1 combo adapter, 2x2 <i>Some:</i> 11ac wireless, M.2 Card, Intel Dual Band Wireless-AC 3165, Wi-Fi + Bluetooth 4.0 combo adapter, 1x1 <i>Some:</i> 11ac wireless, M.2 Card, Intel Dual Band Wireless-AC 8260, Wi-Fi + Bluetooth 4.1 combo adapter, 2x2 <i>Some:</i> 11ac wireless, M.2 Card, Intel Dual Band Wireless-AC 8260, Wi-Fi + Bluetooth 4.1 combo adapter, Intel vPro technology support, 2x2							
Bluetooth™	<i>Some:</i> Bluetooth 4.0 or 4.1 wireless, integrated in Wi-Fi + BT combo adapter							Preload Preloaded operating system <i>Some:</i> Windows® 7 Professional 64 preinstalled through downgrade rights in Windows 10 Pro 64-bit <i>Some:</i> Windows 7 Professional 64 <i>Some:</i> Windows 10 Pro 64-bit <i>Some:</i> Windows 10 Home 64-bit Preloaded applications (only some listed) <ul style="list-style-type: none"> • Desktop Power Manager • Lenovo Solution Center • Lenovo REACHit • Lenovo SHAREit • Lenovo Bluetooth Lock (for models with Wi-Fi/BT card) • McAfee® LiveSafe™ (30-day trial) • Microsoft Office preloaded; purchase a product key to activate • PowerDVD Create (DVD±RW) • Lenovo ThinkVantage Tools • Intel Unite (vPro models only) - Only for Window 10 <ul style="list-style-type: none"> • Lenovo Companion • Cyberlink PowerDVD (DVD, DVD±RW) • Lenovo QuickOptimizer - Only for Window 7 <ul style="list-style-type: none"> • Rescue and Recovery • Password Manager • ThinkVantage System Update • Lenovo Message Center Plus • Adobe® Reader®
Ethernet	Gigabit ethernet, Intel Ethernet Connection I219-LM (Jacksonville), Wake on LAN®							
Modem	None							Environment ENERGY STAR® 6.1*; EPEAT™ Gold rating*; (*Need 85% PSU and Windows OS); ErP Lot 3; GREENGUARD®; RoHS-compliant; TUV Green Mark, ULE Gold
Accessories For compatible accessories, please go to TC-AQP sheet								

See footnotes for more detailed information

Model	Region	Processor	vPro	Graphics	Monitor Cable	Memory	Storage(HDD/SSD)	Optical	Optional 2nd 2.5" Bay	Media Reader	WLAN + Bluetooth	Optional Front Ports	Optional Rear Ports	Chassis Intrusion Switch	Cable Lock	PCI Slot	Dust Filter	Keyboard / Mouse	Stand	Power Supply	Operating System	Warranty	Ann Date (m/y)
10FH000KUS	US	i5-6500	vPro	Intel HD 530	None	4GBx1	500GB 7200rpm 3.5"	DVD±RW	None	None	None	None	None	None	None	None	None	USB / USB	Floor Stand	210W 85%	Win10 DG Win7 Pro 64	3-year, Onsite, OID	11/15
10FH000LUS	US	i7-6700	vPro	GT 720 1GB	None	8GBx1	1TB 7200rpm 3.5"	DVD±RW	None	None	8260 ac, 2x2, vPro + BT4.1	None	None	None	None	None	None	USB / USB	Floor Stand	210W 85%	Win10 Pro 64	3-year, Onsite, OID	11/15
10FH000MUS	US	i7-6700	vPro	GT 720 1GB	None	8GBx1	1TB 7200rpm 3.5"	DVD±RW	None	None	8260 ac, 2x2, vPro + BT4.1	None	None	None	None	None	None	USB / USB	Floor Stand	210W 85%	Win10 DG Win7 Pro 64	3-year, Onsite, OID	11/15
10FH000NUS	US	i5-6500	vPro	Intel HD 530	None	4GBx1	500GB 7200rpm 3.5"	DVD±RW	None	None	None	None	None	None	None	None	None	USB / USB	Floor Stand	210W 85%	Win10 Pro 64	3-year, Onsite, OID	11/15
10FH001YUS	US	i5-6500	vPro	GT 720 1GB	None	4GBx1	500GB 7200rpm 3.5"	DVD±RW	Optional 2nd 2.5" Bay	None	None	None	None	None	None	None	None	USB / USB	Floor Stand	210W 85%	Win10 DG Win7 Pro 64	3-year, Onsite	12/15
10FH0020US	US	i7-6700	vPro	GT 720 1GB	None	8GBx1	1TB 7200rpm 3.5"	DVD±RW	Optional 2nd 2.5" Bay	None	None	None	None	None	None	None	None	USB / USB	Floor Stand	210W 85%	Win10 Pro 64	3-year, Onsite	12/15
10FH0021US	US	i5-6500	vPro	Intel HD 530	None	4GBx1	180GB SSD Opal	DVD±RW	Optional 2nd 2.5" Bay	None	None	None	None	None	None	None	None	USB / USB	Floor Stand	210W 85%	Win10 DG Win7 Pro 64	3-year, Onsite	12/15
10FH0022US	US	i5-6500	vPro	Intel HD 530	None	8GBx1	256GB SSD Opal	DVD±RW	Optional 2nd 2.5" Bay	None	None	None	None	None	None	None	None	USB / USB	Floor Stand	210W 85%	Win10 DG Win7 Pro 64	3-year, Onsite	12/15
10FH0023US	US	i5-6500	vPro	Intel HD 530	None	8GBx1	192GB SSD	DVD±RW	Optional 2nd 2.5" Bay	None	None	None	None	None	None	None	None	USB / USB	Floor Stand	210W 85%	Win10 Pro 64	3-year, Onsite	12/15
10FH0024US	US	i5-6500	vPro	Intel HD 530	None	8GBx1	1TB 7200rpm 3.5"	DVD±RW	Optional 2nd 2.5" Bay	None	8260 ac, 2x2, vPro + BT4.1	None	None	None	None	None	None	USB / USB	Floor Stand	210W 85%	Win10 DG Win7 Pro 64	3-year, Onsite, OID	12/15
10FH0025US	US	i7-6700	vPro	GT 720 1GB	None	8GBx1	256GB SSD Opal	DVD±RW	Optional 2nd 2.5" Bay	None	None	None	None	None	None	None	None	USB / USB	Floor Stand	210W 85%	Win10 DG Win7 Pro 64	3-year, Onsite	12/15
10FH0026US	US	i5-6500	vPro	Intel HD 530	None	8GBx1	180GB SSD Opal	DVD±RW	Optional 2nd 2.5" Bay	None	None	None	None	None	None	None	None	USB / USB	Floor Stand	210W 85%	Win10 Pro 64	3-year, Onsite	12/15
10FH0027US	US	i7-6700	vPro	Intel HD 530	None	8GBx1	256GB SSD Opal	DVD±RW	Optional 2nd 2.5" Bay	None	None	None	None	None	None	None	None	USB / USB	Floor Stand	210W 85%	Win10 DG Win7 Pro 64	3-year, Onsite	12/15
10FH0028US	US	i5-6500	vPro	Intel HD 530	None	4GBx1	128GB SSD	DVD±RW	Optional 2nd 2.5" Bay	None	None	None	None	None	None	None	None	USB / USB	Floor Stand	210W 85%	Win10 DG Win7 Pro 64	3-year, Onsite	12/15
10FH0029US	US	i5-6500	vPro	Intel HD 530	None	4GBx1	192GB SSD	DVD±RW	Optional 2nd 2.5" Bay	None	None	None	None	None	None	None	None	USB / USB	Floor Stand	210W 85%	Win10 DG Win7 Pro 64	3-year, Onsite	12/15
10FH002AUS	US	i7-6700	vPro	Intel HD 530	None	8GBx1	256GB SSD Opal	DVD±RW	Optional 2nd 2.5" Bay	None	None	None	None	None	None	None	None	USB / USB	Floor Stand	210W 85%	Win10 Pro 64	3-year, Onsite	12/15
10FH002BUS	US	i5-6500	vPro	Intel HD 530	None	4GBx1	500GB 7200rpm 3.5"	DVD±RW	Optional 2nd 2.5" Bay	None	None	None	None	None	None	None	None	USB / USB	Floor Stand	210W 85%	Win10 DG Win7 Pro 64	3-year, Onsite, OID	12/15
10FH002CUS	US	i5-6500	vPro	Intel HD 530	None	8GBx1	500GB 7200rpm 3.5"	DVD±RW	Optional 2nd 2.5" Bay	None	None	None	None	None	None	None	None	USB / USB	Floor Stand	210W 85%	Win10 DG Win7 Pro 64	3-year, Onsite, OID	12/15
10FH002DUS	US	i7-6700	vPro	GT 720 1GB	None	8GBx1	1TB 7200rpm 3.5"	DVD±RW	Optional 2nd 2.5" Bay	None	None	None	None	None	None	None	None	USB / USB	Floor Stand	210W 85%	Win10 DG Win7 Pro 64	3-year, Onsite	12/15
10FH002EUS	US	i5-6500	vPro	GT 720 1GB	None	8GBx1	1TB 7200rpm 3.5"	DVD±RW	Optional 2nd 2.5" Bay	None	None	None	None	None	None	None	None	USB / USB	Floor Stand	210W 85%	Win10 DG Win7 Pro 64	3-year, Onsite	12/15

Model	Region	Processor	vPro	Graphics	Monitor Cable	Memory	Storage(HDD/SSD)	Optical	Optional 2nd 2.5" Bay	Media Reader	WLAN + Bluetooth	Optional Front Ports	Optional Rear Ports	Chassis Intrusion Switch	Cable Lock	PCI Slot	Dust Filter	Keyboard / Mouse	Stand	Power Supply	Operating System	Warranty	Ann Date (m/y)
10FH002FUS	US	i5-6500	vPro	Intel HD 530	None	8GBx1	1TB 7200rpm 3.5"	DVD±RW	Optional 2nd 2.5" Bay	None	None	None	None	None	None	None	None	USB / USB	Floor Stand	210W 85%	Win10 DG Win7 Pro 64	3-year, Onsite, OID	12/15
10FH002GUS	US	i5-6500	vPro	GT 720 1GB	None	8GBx1	1TB 7200rpm 3.5"	DVD±RW	Optional 2nd 2.5" Bay	None	None	None	None	None	None	None	None	USB / USB	Floor Stand	210W 85%	Win10 Pro 64	3-year, Onsite	12/15
10FH002HUS	US	i7-6700	vPro	Intel HD 530	None	8GBx1	1TB 7200rpm 3.5"	DVD±RW	Optional 2nd 2.5" Bay	None	None	None	None	None	None	None	None	USB / USB	Floor Stand	210W 85%	Win10 DG Win7 Pro 64	3-year, Onsite, OID	12/15
10FH002JUS	US	i5-6500	vPro	Intel HD 530	None	8GBx1	128GB SSD	DVD±RW	Optional 2nd 2.5" Bay	None	None	None	None	None	None	None	None	USB / USB	Floor Stand	210W 85%	Win10 Pro 64	3-year, Onsite	12/15
10FH002KUS	US	i5-6500	vPro	Intel HD 530	None	4GBx1	500GB 7200rpm 3.5"	DVD±RW	Optional 2nd 2.5" Bay	None	8260 ac, 2x2, vPro + BT4.1	None	None	None	None	None	None	USB / USB	Floor Stand	210W 85%	Win10 DG Win7 Pro 64	3-year, Onsite, OID	12/15
10FH002LUS	US	i7-6700	vPro	Intel HD 530	None	8GBx1	1TB 7200rpm 3.5"	DVD±RW	Optional 2nd 2.5" Bay	None	8260 ac, 2x2, vPro + BT4.1	None	None	None	None	None	None	USB / USB	Floor Stand	210W 85%	Win10 DG Win7 Pro 64	3-year, Onsite, OID	12/15
10FH003MUS	US	i5-6500	vPro	Intel HD 530	None	8GBx1	128GB SSD	DVD±RW	Optional 2nd 2.5" Bay	None	None	None	None	None	None	None	None	USB / USB	Floor Stand	210W 85%	Win10 DG Win7 Pro 64	3-year, Onsite	03/16
10FH003NUS	US	i5-6500	vPro	Intel HD 530	None	8GBx1	500GB 7200rpm 3.5"	DVD±RW	Optional 2nd 2.5" Bay	None	None	None	None	None	None	None	None	USB / USB	Floor Stand	210W 85%	Win10 DG Win7 Pro 64	3-year, Onsite	03/16
10FH004JUS	US	i5-6500	vPro	Intel HD 530	None	4GBx1	500GB 7200rpm 3.5"	DVD±RW	Optional 2nd 2.5" Bay	None	None	None	None	None	None	None	None	USB / USB	Floor Stand	210W 85%	Win10 Pro 64	3-year, Onsite	07/16
10FH0054US	US	i7-6700	vPro	GT 720 1GB	None	8GBx1	1TB 7200rpm 3.5"	DVD±RW	Optional 2nd 2.5" Bay	None	8260 ac, 2x2, vPro + BT4.1	None	None	None	None	None	None	USB / USB	Floor Stand	210W 85%	Win10 Pro 64	3-year, Onsite	07/16
10FH005JUS	US	i7-6700	vPro	GT 720 1GB	None	8GBx1	1TB 7200rpm 3.5"	DVD±RW	Optional 2nd 2.5" Bay	None	None	None	None	None	None	None	None	USB / USB	Floor Stand	210W 85%	Win10 DG Win7 Pro 64	3-year, Onsite	10/16
10FH005KUS	US	i7-6700	vPro	GT 720 1GB	None	8GBx1	256GB SSD Opal	DVD±RW	Optional 2nd 2.5" Bay	None	None	None	None	None	None	None	None	USB / USB	Floor Stand	210W 85%	Win10 DG Win7 Pro 64	3-year, Onsite	10/16
10FH005LUS	US	i5-6500	vPro	GT 720 1GB	None	4GBx1	500GB 7200rpm 2.5"	DVD±RW	Optional 2nd 2.5" Bay	None	None	None	None	None	None	None	None	USB / USB	Floor Stand	210W 85%	Win10 Pro 64	3-year, Onsite	10/16
10FH005MUS	US	i5-6500	vPro	GT 720 1GB	None	8GBx1	1TB 7200rpm 3.5"	DVD±RW	Optional 2nd 2.5" Bay	None	None	None	None	None	None	None	None	USB / USB	Floor Stand	210W 85%	Win10 DG Win7 Pro 64	3-year, Onsite	10/16
10FH005NUS	US	i7-6700	vPro	GT 720 1GB	None	8GBx1	1TB 7200rpm 3.5"	DVD±RW	Optional 2nd 2.5" Bay	None	None	None	None	None	None	None	None	USB / USB	Floor Stand	210W 85%	Win10 Pro 64	3-year, Onsite	10/16
10FH005PUS	US	i5-6500	vPro	GT 720 1GB	None	4GBx1	500GB 7200rpm 2.5"	DVD±RW	Optional 2nd 2.5" Bay	None	None	None	None	None	None	None	None	USB / USB	Floor Stand	210W 85%	Win10 DG Win7 Pro 64	3-year, Onsite	10/16
10FH005QUS	US	i7-6700	vPro	GT 720 1GB	None	8GBx1	1TB 7200rpm 3.5"	DVD±RW	Optional 2nd 2.5" Bay	None	8260 ac, 2x2, vPro + BT4.1	None	None	None	None	None	None	USB / USB	Floor Stand	210W 85%	Win10 DG Win7 Pro 64	3-year, Onsite	10/16
10FH005RUS	US	i5-6500	vPro	GT 720 1GB	None	8GBx1	1TB 7200rpm 3.5"	DVD±RW	Optional 2nd 2.5" Bay	None	None	None	None	None	None	None	None	USB / USB	Floor Stand	210W 85%	Win10 Pro 64	3-year, Onsite	10/16
10FH005SUS	US	i7-6700	vPro	GT 720 1GB	None	8GBx1	1TB 7200rpm 3.5"	DVD±RW	Optional 2nd 2.5" Bay	None	8260 ac, 2x2, vPro + BT4.1	None	None	None	None	None	None	USB / USB	Floor Stand	210W 85%	Win10 Pro 64	3-year, Onsite	10/16
10FH005TUS	US	i7-6700	vPro	GT 720 1GB	None	8GBx1	256GB SSD Opal	DVD±RW	Optional 2nd 2.5" Bay	None	None	None	None	None	None	None	None	USB / USB	Floor Stand	210W 85%	Win10 Pro 64	3-year, Onsite	10/16

Model	Region	Processor	vPro	Graphics	Monitor Cable	Memory	Storage(HDD/SSD)	Optical	Optional 2nd 2.5" Bay	Media Reader	WLAN + Bluetooth	Optional Front Ports	Optional Rear Ports	Chassis Intrusion Switch	Cable Lock	PCI Slot	Dust Filter	Keyboard / Mouse	Stand	Power Supply	Operating System	Warranty	Ann Date (m/y)
10FG0006US	US	i5-6500	vPro	Intel HD 530	None	4GBx1	500GB 7200rpm 3.5"	DVD±RW	None	None	None	None	None	None	None	None	None	USB / USB	Floor Stand	210W 85%	Win10 DG Win7 Pro 64	3-year, Onsite, OID	11/15
10FG0007US	US	i7-6700	vPro	GT 720 1GB	None	8GBx1	1TB 7200rpm 3.5"	DVD±RW	None	None	8260 ac, 2x2, vPro + BT4.1	None	None	None	None	None	None	USB / USB	Floor Stand	210W 85%	Win10 DG Win7 Pro 64	3-year, Onsite, OID	11/15
10FG000XUS	US	i5-6500	vPro	Intel HD 530	None	4GBx1	500GB 7200rpm 3.5"	DVD	None	None	None	None	None	None	None	None	None	USB / USB	None	210W 85%	Win10 Pro 64	3-year, Onsite, OID	11/15
10FG000YUS	US	i5-6600	vPro	Intel HD 530	None	4GBx1	500GB 7200rpm 3.5"	DVD±RW	None	None	None	None	None	None	None	None	None	USB / USB	None	210W 85%	Win10 Pro 64	3-year, Onsite, OID	11/15
10FG0013US	US	i7-6700	vPro	GT 720 1GB	None	4GBx1	1TB 7200rpm 3.5"	DVD±RW	None	9-in-1	None	None	None	None	None	None	None	USB / USB	None	210W 85%	Win10 Pro 64	3-year, Onsite, OID	11/15
10FG0014US	US	i7-6700	vPro	GT 720 1GB	None	4GBx1	1TB 7200rpm 3.5"	DVD±RW	None	9-in-1	None	None	None	None	None	None	Dust Filter	USB / USB	None	210W 85%	Win10 DG Win7 Pro 64	3-year, Onsite, OID	11/15
10FG0015US	US	i5-6600	vPro	Intel HD 530	None	4GBx1	500GB 7200rpm 3.5"	DVD±RW	None	None	None	None	None	None	None	None	None	USB / USB	None	210W 85%	Win10 DG Win7 Pro 64	3-year, Onsite, OID	11/15
10FG0016US	US	i5-6500	vPro	Intel HD 530	None	4GBx1	500GB 7200rpm 3.5"	DVD	None	None	None	None	None	None	None	None	None	USB / USB	None	210W 85%	Win10 DG Win7 Pro 64	3-year, Onsite, OID	11/15



ThinkCentre M900 Tiny Platform Specifications

Product Specifications Reference (PSREF)

Processor	Intel® Celeron®, Intel Pentium®, or 6th Generation Intel Core™ i3 / i5 / i7 Processor	Security features	<ul style="list-style-type: none"> Security slot (in rear for optional Kensington® MicroSaver® cable) Administrator password Padlock loop Hard disk password Smart USB protection, allows keyboard/mouse only, blocks all storage devices Boot sequence control Power-on password Boot without keyboard and mouse Individual USB port disablement Chassis intrusion switch 																																																															
	<table border="1"> <thead> <tr> <th>Processor</th> <th>Cores / Threads</th> <th>Frequency Base/Max(GHz)</th> <th>Cache</th> <th>Memory Types</th> <th>Integrated Graphics</th> <th>Intel vPro</th> </tr> </thead> <tbody> <tr> <td>Pentium G4400T</td> <td>2 / 2</td> <td>2.9 G</td> <td>3 MB</td> <td>DDR4-2133</td> <td>HD 510</td> <td>No</td> </tr> <tr> <td>Pentium G4500T</td> <td>2 / 2</td> <td>3.0 G</td> <td>3 MB</td> <td>DDR4-2133</td> <td>HD 530</td> <td>No</td> </tr> <tr> <td>Core i3-6100T</td> <td>2 / 4</td> <td>3.2 G</td> <td>3 MB</td> <td>DDR4-2133</td> <td>HD 530</td> <td>No</td> </tr> <tr> <td>Core i3-6300T</td> <td>2 / 4</td> <td>3.3 G</td> <td>4 MB</td> <td>DDR4-2133</td> <td>HD 530</td> <td>No</td> </tr> <tr> <td>Core i5-6400T</td> <td>4 / 4</td> <td>2.2 G / 2.8 G</td> <td>6 MB</td> <td>DDR4-2133</td> <td>HD 530</td> <td>No</td> </tr> <tr> <td>Core i5-6500T</td> <td>4 / 4</td> <td>2.5 G / 3.1 G</td> <td>6 MB</td> <td>DDR4-2133</td> <td>HD 530</td> <td>vPro</td> </tr> <tr> <td>Core i5-6600T</td> <td>4 / 4</td> <td>2.7 G / 3.5 G</td> <td>6 MB</td> <td>DDR4-2133</td> <td>HD 530</td> <td>vPro</td> </tr> <tr> <td>Core i7-6700T</td> <td>4 / 8</td> <td>2.8 G / 3.6 G</td> <td>8 MB</td> <td>DDR4-2133</td> <td>HD 530</td> <td>vPro</td> </tr> </tbody> </table>	Processor	Cores / Threads	Frequency Base/Max(GHz)	Cache	Memory Types	Integrated Graphics	Intel vPro	Pentium G4400T	2 / 2	2.9 G	3 MB	DDR4-2133	HD 510	No	Pentium G4500T	2 / 2	3.0 G	3 MB	DDR4-2133	HD 530	No	Core i3-6100T	2 / 4	3.2 G	3 MB	DDR4-2133	HD 530	No	Core i3-6300T	2 / 4	3.3 G	4 MB	DDR4-2133	HD 530	No	Core i5-6400T	4 / 4	2.2 G / 2.8 G	6 MB	DDR4-2133	HD 530	No	Core i5-6500T	4 / 4	2.5 G / 3.1 G	6 MB	DDR4-2133	HD 530	vPro	Core i5-6600T	4 / 4	2.7 G / 3.5 G	6 MB	DDR4-2133	HD 530	vPro	Core i7-6700T	4 / 8	2.8 G / 3.6 G	8 MB	DDR4-2133	HD 530	vPro	Keyboard	<i>Some:</i> Preferred Pro USB Keyboard (USB connector), Lenovo logo <i>Some:</i> Lenovo USB Fingerprint Keyboard (USB connector) <i>Some:</i> Ultralim Plus Wireless Keyboard (2.4GHz via USB receiver), black <i>Some:</i> Enhanced Optical USB Mouse, black, Lenovo logo <i>Some:</i> Ultralim Plus Wireless Mouse (2.4GHz via USB receiver), black
Processor	Cores / Threads	Frequency Base/Max(GHz)	Cache	Memory Types	Integrated Graphics	Intel vPro																																																												
Pentium G4400T	2 / 2	2.9 G	3 MB	DDR4-2133	HD 510	No																																																												
Pentium G4500T	2 / 2	3.0 G	3 MB	DDR4-2133	HD 530	No																																																												
Core i3-6100T	2 / 4	3.2 G	3 MB	DDR4-2133	HD 530	No																																																												
Core i3-6300T	2 / 4	3.3 G	4 MB	DDR4-2133	HD 530	No																																																												
Core i5-6400T	4 / 4	2.2 G / 2.8 G	6 MB	DDR4-2133	HD 530	No																																																												
Core i5-6500T	4 / 4	2.5 G / 3.1 G	6 MB	DDR4-2133	HD 530	vPro																																																												
Core i5-6600T	4 / 4	2.7 G / 3.5 G	6 MB	DDR4-2133	HD 530	vPro																																																												
Core i7-6700T	4 / 8	2.8 G / 3.6 G	8 MB	DDR4-2133	HD 530	vPro																																																												
Memory	32GB max, DDR4 2133, two 260-pin SO-DIMM sockets, dual-channel capable	Mouse																																																																
Disk	<i>Some:</i> SATA 6.0Gb/s, 2.5" Wide, 5400 rpm or 7200 rpm <i>Some:</i> 500GB (5400 rpm) Solid State Hybrid Drive (SSHD) / with 8GB MLC NAND flash memory, SATA 6.0Gb/s, 2.5" wide <i>Some:</i> Solid State Drive (SSD) / SATA 6.0Gb/s, 2.5" Wide <i>Some:</i> M.2 SSD, PCIe or SATA interface	Mechanical	Tiny (1L), black color; metal case M900 Tiny only: 7.05" W X 7.20" D X 1.36" H 179mm W X 182.9mm D X 34.5mm H 2.9 lb (1.3 kg), weight may vary by configuration With VESA mount & ODD box: 7.42" W X 7.30" D X 2.48" H 188.4mm W X 185.38mm D X 63mm H 4.12 lb (1.87 kg), weight may vary by configuration With VESA mount & I/O box: 7.42" W X 7.30" D X 2.62" H 188.4mm W X 185.38mm D X 66.6mm H 3.53 lb (1.6 kg), weight may vary by configuration Optional VESA mount bracket kit, supports VESA 75mm and 100mm Optional system floor stand for vertical orientation																																																															
Optical	<i>Some:</i> external ODD box with DVD-ROM, 9.5mm high, via USB <i>Some:</i> external ODD box with DVD±RW, 9.5mm high, via USB <i>Some:</i> external ODD box (for TIO) with DVD-ROM, 9.5mm high, via USB <i>Some:</i> external ODD box (for TIO) with DVD±RW, 9.5mm high, via USB	VESA mount																																																																
Onboard SATA	One SATA cable (1-drop to device), one SATA 6.0Gb/s connector on planar	Floor Stand	Optional system floor stand for vertical orientation																																																															
Media reader	None	Power supply	65 watts AC/DC adapter, autosensing, 88% PSU (not included for TIO models) 90 watts AC/DC adapter, autosensing, 88% PSU (only for models with I/O box)																																																															
Graphics	Intel HD Graphics 510/530 in processor, uses main memory, DirectX® 12, two DisplayPort™, one optional HDMI, VGA, or 3rd DP, up to 3 independent displays; Max resolution: 4096x2304 (DP) @60Hz; 4096x2160 (HDMI) @24Hz; 1920x1200 (VGA) @60Hz	Limited warranty ³	<i>Some:</i> 1-year or 3-year, depot service / service upgrades available <i>Some:</i> 1-year or 3-year, limited onsite service / service upgrades available <i>Some:</i> 3-year, limited onsite service, OID (Onsite International Delivery) / service upgrades available <i>For Lenovo service upgrade options, please go to S-TC sheet</i>																																																															
DP cable	Optional DP to VGA, DP to DVI-D (single link), or DP to HDMI 1.4 dongle	Preload	Preloaded operating system <i>Some:</i> Windows® 7 Professional 64 preinstalled through downgrade rights in Windows 10 Pro 64-bit <i>Some:</i> Windows 7 Professional 64 <i>Some:</i> Windows 10 Pro 64-bit <i>Some:</i> Windows 10 Home 64-bit Preloaded applications (only some listed) <ul style="list-style-type: none"> Desktop Power Manager Lenovo Solution Center Lenovo REACHit Lenovo SHAREit Lenovo Bluetooth Lock (for models with Wi-Fi/BT card) McAfee® LiveSafe™ (30-day trial) Microsoft Office preloaded; purchase a product key to activate PowerDVD Create (DVD±RW) Lenovo ThinkVantage Tools Intel Unite (vPro models only) - Only for Window 10 Lenovo Companion Cyberlink PowerDVD (DVD, DVD±RW) Lenovo QuickOptimizer - Only for Window 7 Rescue and Recovery Password Manager ThinkVantage System Update Lenovo Message Center Plus Adobe® Reader® 																																																															
Chipset	Intel Q170 Chipset	Environment	ENERGY STAR® 6.1*; EPEAT™ Gold rating*; (*Need 85% PSU and Windows OS); ErP Lot 3; GREENGUARD®; RoHS-compliant; TUV Green Mark, ULE Gold																																																															
Front ports	Two USB 3.0 (one is Always On and fast charge), one microphone (stereo, 3.5mm), one headphone / microphone combo jack (stereo, 3.5mm)	MIL-SPEC test	MIL-STD-810G military certification (Low Pressure [Altitude], High Temperature, Low Temperature, Temperature Shock, Humidity, Sand and Dust, Vibration, Shock)																																																															
Rear ports	Four USB 3.0 (optional external optical box or external I/O box occupies one or two specific USB 3.0 on some models), ethernet (RJ-45), two DisplayPort, one optional port (VGA, 3rd DP, HDMI, or serial on some models), one headphone	Accessories	For compatible accessories, please go to TC-AQP sheet																																																															
I/O box	Optional external I/O box, extends two USB 2.0, two USB 3.0, and one serial on rear, two USB 2.0 on front, via USB (occupy two specific USB 3.0 of M900 Tiny)																																																																	
Audio support	High Definition (HD) Audio, Realtek ALC223 / optional internal speaker (1 watt)																																																																	
WLAN ¹³	<i>Some:</i> 11ac wireless, M.2 Card, Qualcomm Atheros QCA9377 (dual band), Wi-Fi + Bluetooth 4.1 combo adapter, 1x1 <i>Some:</i> 11ac wireless, M.2 Card, Qualcomm Atheros QCA6174 (dual band), Wi-Fi + Bluetooth 4.1 combo adapter, 2x2 <i>Some:</i> 11ac wireless, M.2 Card, Intel Dual Band Wireless-AC 3165, Wi-Fi + Bluetooth 4.0 combo adapter, 1x1 <i>Some:</i> 11ac wireless, M.2 Card, Intel Dual Band Wireless-AC 8260, Wi-Fi + Bluetooth 4.1 combo adapter, 2x2 <i>Some:</i> 11ac wireless, M.2 Card, Intel Dual Band Wireless-AC 8260, Wi-Fi + Bluetooth 4.1 combo adapter, Intel vPro technology support, 2x2																																																																	
Bluetooth™	<i>Some:</i> Bluetooth 4.0 or 4.1 wireless, integrated in Wi-Fi + BT combo adapter																																																																	
Ethernet	Gigabit ethernet, Intel Ethernet Connection I219-LM (Jacksonville), Wake on LAN®																																																																	
Modem	None																																																																	
Manageability	Intel Active Management Technology 11.0 (Intel AMT 11.0); Intel vPro technology on some models (require choosing a vPro-support Wi-Fi adapter to enable vPro function through wireless connection)																																																																	
Security chip	Trusted Platform Module, TCG 1.2-compliant																																																																	

See footnotes for more detailed information

Model	Region	Processor	vPro	Graphics	Monitor Cable	Memory	Storage(HDD/SSD)	External Optical / I/O Box	WLAN + Bluetooth	Optional Rear Ports	Chassis Intrusion Switch	Kensington Cable Lock	Speaker	Adapter Cage	Toolless Chassis Screw	Dust Filter	Keyboard / Mouse	VESA Mount	Stand	Power Supply	Operating System	Warranty	Ann Date (m/y)
10FM0006US	US	i5-6500T	vPro	Intel HD 530	None	4GBx1	120GB SSD	None	8260 ac, 2x2, vPro + BT4.1	3rd DP	Switch	None	1Wx1	None	None	None	USB / USB	None	Floor Stand	65W Adapter 88%	Win10 DG Win7 Pro 64	3-year, Onsite	11/15
10FM0007US	US	i5-6500T	vPro	Intel HD 530	None	4GBx1	500GB 7200rpm 2.5"	None	8260 ac, 2x2, vPro + BT4.1	3rd DP	Switch	None	1Wx1	None	None	None	USB / USB	None	Floor Stand	65W Adapter 88%	Win10 DG Win7 Pro 64	3-year, Onsite	11/15
10FM0008US	US	i7-6700T	vPro	Intel HD 530	None	8GBx1	120GB SSD	DVD±RW	8260 ac, 2x2, vPro + BT4.1	HDMI	Switch	None	1Wx1	None	None	None	USB / USB	VESA Mount	None	65W Adapter 88%	Win10 DG Win7 Pro 64	3-year, Onsite	11/15
10FM0009US	US	i5-6500T	vPro	Intel HD 530	None	4GBx1	500GB 7200rpm 2.5"	None	8260 ac, 2x2, vPro + BT4.1	None	Switch	None	1Wx1	None	None	None	USB / USB	None	Floor Stand	65W Adapter 88%	Win10 DG Win7 Pro 64	3-year, Onsite	11/15
10FM000AUS	US	i5-6500T	vPro	Intel HD 530	None	4GBx1	120GB SSD	DVD±RW	8260 ac, 2x2, vPro + BT4.1	HDMI	Switch	None	1Wx1	None	None	None	USB / USB	VESA Mount	None	65W Adapter 88%	Win10 DG Win7 Pro 64	3-year, Onsite	11/15
10FM000BUS	US	i7-6700T	vPro	Intel HD 530	None	8GBx1	120GB SSD	None	8260 ac, 2x2, vPro + BT4.1	3rd DP	Switch	None	1Wx1	None	None	None	USB / USB	None	Floor Stand	65W Adapter 88%	Win10 DG Win7 Pro 64	3-year, Onsite	11/15
10FM0014US	US	i5-6500T	vPro	Intel HD 530	None	8GBx1	128GB SSD	DVD±RW	8260 ac, 2x2, vPro + BT4.1	HDMI	Switch	None	1Wx1	None	None	None	USB / USB	VESA Mount	None	65W Adapter 88%	Win10 DG Win7 Pro 64	3-year, Onsite	12/15
10FM0017US	US	i5-6500T	vPro	Intel HD 530	None	4GBx1	128GB SSD	None	8260 ac, 2x2, vPro + BT4.1	HDMI	Switch	None	1Wx1	None	None	None	USB / USB	None	Floor Stand	65W Adapter 88%	Win10 DG Win7 Pro 64	3-year, Onsite	12/15
10FM0018US	US	i7-6700T	vPro	Intel HD 530	None	8GBx1	180GB SSD Opal	DVD±RW	8260 ac, 2x2, vPro + BT4.1	HDMI	Switch	None	1Wx1	None	None	None	USB / USB	VESA Mount	None	65W Adapter 88%	Win10 DG Win7 Pro 64	3-year, Onsite	12/15
10FM0019US	US	i7-6700T	vPro	Intel HD 530	None	8GBx1	256GB SSD Opal	DVD±RW	8260 ac, 2x2, vPro + BT4.1	Serial	Switch	None	1Wx1	None	None	None	USB / USB	VESA Mount	None	65W Adapter 88%	Win10 DG Win7 Pro 64	3-year, Onsite	12/15
10FM001AUS	US	i7-6700T	vPro	Intel HD 530	None	8GBx1	500GB 7200rpm 2.5"	DVD±RW	8260 ac, 2x2, vPro + BT4.1	None	Switch	None	1Wx1	None	None	None	USB / USB	VESA Mount	None	65W Adapter 88%	Win10 DG Win7 Pro 64	3-year, Onsite	12/15
10FM001BUS	US	i7-6700T	vPro	Intel HD 530	None	8GBx1	256GB SSD Opal	DVD±RW	8260 ac, 2x2, vPro + BT4.1	HDMI	Switch	None	1Wx1	None	None	None	USB / USB	VESA Mount	None	65W Adapter 88%	Win10 DG Win7 Pro 64	3-year, Onsite	12/15
10FM001CUS	US	i5-6500T	vPro	Intel HD 530	None	4GBx1	500GB 7200rpm 2.5"	DVD±RW	8260 ac, 2x2, vPro + BT4.1	None	Switch	None	1Wx1	None	None	None	USB / USB	VESA Mount	None	65W Adapter 88%	Win10 DG Win7 Pro 64	3-year, Onsite	12/15
10FM001DUS	US	i7-6700T	vPro	Intel HD 530	None	8GBx1	180GB SSD Opal	DVD±RW	8260 ac, 2x2, vPro + BT4.1	3rd DP	Switch	None	1Wx1	None	None	None	USB / USB	VESA Mount	None	65W Adapter 88%	Win10 DG Win7 Pro 64	3-year, Onsite	12/15
10FM001EUS	US	i5-6500T	vPro	Intel HD 530	None	4GBx1	500GB 7200rpm 2.5"	DVD±RW	8260 ac, 2x2, vPro + BT4.1	3rd DP	Switch	None	1Wx1	None	None	None	USB / USB	VESA Mount	None	65W Adapter 88%	Win10 DG Win7 Pro 64	3-year, Onsite	12/15
10FM001FUS	US	i5-6500T	vPro	Intel HD 530	None	8GBx1	256GB SSD Opal	DVD±RW	8260 ac, 2x2, vPro + BT4.1	HDMI	Switch	None	1Wx1	None	None	None	USB / USB	VESA Mount	None	65W Adapter 88%	Win10 DG Win7 Pro 64	3-year, Onsite	12/15
10FM001GUS	US	i7-6700T	vPro	Intel HD 530	None	8GBx1	128GB SSD	None	8260 ac, 2x2, vPro + BT4.1	HDMI	Switch	None	1Wx1	None	None	None	USB / USB	None	Floor Stand	65W Adapter 88%	Win10 DG Win7 Pro 64	3-year, Onsite	12/15
10FM001HUS	US	i5-6500T	vPro	Intel HD 530	None	8GBx1	192GB SSD	DVD±RW	8260 ac, 2x2, vPro + BT4.1	HDMI	Switch	None	1Wx1	None	None	None	USB / USB	VESA Mount	None	65W Adapter 88%	Win10 DG Win7 Pro 64	3-year, Onsite	12/15
10FM001JUS	US	i7-6700T	vPro	Intel HD 530	None	8GBx1	128GB SSD	DVD±RW	8260 ac, 2x2, vPro + BT4.1	3rd DP	Switch	None	1Wx1	None	None	None	USB / USB	VESA Mount	None	65W Adapter 88%	Win10 DG Win7 Pro 64	3-year, Onsite	12/15
10FM001KUS	US	i7-6700T	vPro	Intel HD 530	None	8GBx1	192GB SSD	DVD±RW	8260 ac, 2x2, vPro + BT4.1	HDMI	Switch	None	1Wx1	None	None	None	USB / USB	VESA Mount	None	65W Adapter 88%	Win10 DG Win7 Pro 64	3-year, Onsite	12/15

Model	Region	Processor	vPro	Graphics	Monitor Cable	Memory	Storage(HDD/SSD)	External Optical / I/O Box	WLAN + Bluetooth	Optional Rear Ports	Chassis Intrusion Switch	Kensington Cable Lock	Speaker	Adapter Cage	Toolless Chassis Screw	Dust Filter	Keyboard / Mouse	VESA Mount	Stand	Power Supply	Operating System	Warranty	Ann Date (m/y)
10FM001LUS	US	i7-6700T	vPro	Intel HD 530	None	8GBx1	192GB SSD	DVD±RW	8260 ac, 2x2, vPro + BT4.1	3rd DP	Switch	None	1Wx1	None	None	None	USB / USB	VESA Mount	None	65W Adapter 88%	Win10 DG Win7 Pro 64	3-year, Onsite	12/15
10FM001MUS	US	i5-6500T	vPro	Intel HD 530	None	4GBx1	128GB SSD	DVD±RW	8260 ac, 2x2, vPro + BT4.1	3rd DP	Switch	None	1Wx1	None	None	None	USB / USB	VESA Mount	None	65W Adapter 88%	Win10 DG Win7 Pro 64	3-year, Onsite	12/15
10FM001NUS	US	i5-6500T	vPro	Intel HD 530	None	4GBx1	128GB SSD	None	8260 ac, 2x2, vPro + BT4.1	3rd DP	Switch	None	1Wx1	None	None	None	USB / USB	None	Floor Stand	65W Adapter 88%	Win10 DG Win7 Pro 64	3-year, Onsite	12/15
10FM001PUS	US	i5-6500T	vPro	Intel HD 530	None	4GBx1	500GB 7200rpm 2.5"	None	8260 ac, 2x2, vPro + BT4.1	Serial	Switch	None	1Wx1	None	None	None	USB / USB	None	Floor Stand	65W Adapter 88%	Win10 DG Win7 Pro 64	3-year, Onsite	12/15
10FM001QUS	US	i5-6500T	vPro	Intel HD 530	None	4GBx1	128GB SSD	None	8260 ac, 2x2, vPro + BT4.1	None	Switch	None	1Wx1	None	None	None	USB / USB	None	Floor Stand	65W Adapter 88%	Win10 DG Win7 Pro 64	3-year, Onsite	12/15
10FM001RUS	US	i5-6500T	vPro	Intel HD 530	None	8GBx1	192GB SSD	None	8260 ac, 2x2, vPro + BT4.1	None	Switch	None	1Wx1	None	None	None	USB / USB	None	Floor Stand	65W Adapter 88%	Win10 DG Win7 Pro 64	3-year, Onsite	12/15
10FM001SUS	US	i5-6500T	vPro	Intel HD 530	None	8GBx1	180GB SSD Opal	None	8260 ac, 2x2, vPro + BT4.1	3rd DP	Switch	None	1Wx1	None	None	None	USB / USB	None	Floor Stand	65W Adapter 88%	Win10 DG Win7 Pro 64	3-year, Onsite	12/15
10FM001TUS	US	i5-6500T	vPro	Intel HD 530	None	4GBx1	500GB 7200rpm 2.5"	None	8260 ac, 2x2, vPro + BT4.1	HDMI	Switch	None	1Wx1	None	None	None	USB / USB	None	Floor Stand	65W Adapter 88%	Win10 DG Win7 Pro 64	3-year, Onsite	12/15
10FM001UUS	US	i5-6500T	vPro	Intel HD 530	None	8GBx1	256GB SSD Opal	None	8260 ac, 2x2, vPro + BT4.1	3rd DP	Switch	None	1Wx1	None	None	None	USB / USB	None	Floor Stand	65W Adapter 88%	Win10 DG Win7 Pro 64	3-year, Onsite	12/15
10FM001VUS	US	i7-6700T	vPro	Intel HD 530	None	8GBx1	128GB SSD	None	8260 ac, 2x2, vPro + BT4.1	3rd DP	Switch	None	1Wx1	None	None	None	USB / USB	None	Floor Stand	65W Adapter 88%	Win10 DG Win7 Pro 64	3-year, Onsite	12/15
10FM001WUS	US	i7-6700T	vPro	Intel HD 530	None	8GBx1	192GB SSD	None	8260 ac, 2x2, vPro + BT4.1	3rd DP	Switch	None	1Wx1	None	None	None	USB / USB	None	Floor Stand	65W Adapter 88%	Win10 DG Win7 Pro 64	3-year, Onsite	12/15
10FM001XUS	US	i7-6700T	vPro	Intel HD 530	None	8GBx1	500GB 7200rpm 2.5"	None	8260 ac, 2x2, vPro + BT4.1	None	Switch	None	1Wx1	None	None	None	USB / USB	None	Floor Stand	65W Adapter 88%	Win10 DG Win7 Pro 64	3-year, Onsite	12/15
10FM001YUS	US	i7-6700T	vPro	Intel HD 530	None	8GBx1	180GB SSD Opal	None	8260 ac, 2x2, vPro + BT4.1	3rd DP	Switch	None	1Wx1	None	None	None	USB / USB	None	Floor Stand	65W Adapter 88%	Win10 DG Win7 Pro 64	3-year, Onsite	12/15
10FM0020US	US	i7-6700T	vPro	Intel HD 530	None	8GBx1	128GB SSD	None	8260 ac, 2x2, vPro + BT4.1	None	Switch	None	1Wx1	None	None	None	USB / USB	None	Floor Stand	65W Adapter 88%	Win10 DG Win7 Pro 64	3-year, Onsite	12/15
10FM0021US	US	i7-6700T	vPro	Intel HD 530	None	8GBx1	256GB SSD Opal	None	8260 ac, 2x2, vPro + BT4.1	3rd DP	Switch	None	1Wx1	None	None	None	USB / USB	None	Floor Stand	65W Adapter 88%	Win10 DG Win7 Pro 64	3-year, Onsite	12/15
10FM0022US	US	i7-6700T	vPro	Intel HD 530	None	8GBx1	128GB SSD	None	8260 ac, 2x2, vPro + BT4.1	3rd DP	Switch	None	1Wx1	None	None	None	USB / USB	None	Floor Stand	65W Adapter 88%	Win10 Pro 64	3-year, Onsite	12/15
10FM0023US	US	i5-6500T	vPro	Intel HD 530	None	4GBx1	500GB 7200rpm 2.5"	DVD±RW	8260 ac, 2x2, vPro + BT4.1	3rd DP	Switch	None	1Wx1	None	None	None	USB / USB	VESA Mount	None	65W Adapter 88%	Win10 Pro 64	3-year, Onsite	12/15
10FM0024US	US	i5-6500T	vPro	Intel HD 530	None	8GBx1	128GB SSD	DVD±RW	8260 ac, 2x2, vPro + BT4.1	3rd DP	Switch	None	1Wx1	None	None	None	USB / USB	VESA Mount	None	65W Adapter 88%	Win10 Pro 64	3-year, Onsite	12/15
10FM0025US	US	i7-6700T	vPro	Intel HD 530	None	8GBx1	128GB SSD	DVD±RW	8260 ac, 2x2, vPro + BT4.1	3rd DP	Switch	None	1Wx1	None	None	None	USB / USB	VESA Mount	None	65W Adapter 88%	Win10 Pro 64	3-year, Onsite	12/15
10FM0026US	US	i5-6500T	vPro	Intel HD 530	None	8GBx1	128GB SSD	None	8260 ac, 2x2, vPro + BT4.1	3rd DP	Switch	None	1Wx1	None	None	None	USB / USB	None	Floor Stand	65W Adapter 88%	Win10 Pro 64	3-year, Onsite	12/15

Model	Region	Processor	vPro	Graphics	Monitor Cable	Memory	Storage(HDD/SSD)	External Optical / I/O Box	WLAN + Bluetooth	Optional Rear Ports	Chassis Intrusion Switch	Kensington Cable Lock	Speaker	Adapter Cage	Toolless Chassis Screw	Dust Filter	Keyboard / Mouse	VESA Mount	Stand	Power Supply	Operating System	Warranty	Ann Date (m/y)
10FM0027US	US	i5-6500T	vPro	Intel HD 530	None	4GBx1	500GB 7200rpm 2.5"	None	8260 ac, 2x2, vPro + BT4.1	3rd DP	Switch	None	1Wx1	None	None	None	USB / USB	None	Floor Stand	65W Adapter 88%	Win10 Pro 64	3-year, Onsite	12/15
10FM002TUS	US	i7-6700T	vPro	Intel HD 530	None	8GBx1	256GB SSD Opal	None	8260 ac, 2x2, vPro + BT4.1	VGA	Switch	None	1Wx1	None	None	None	USB / USB	None	Floor Stand	65W Adapter 88%	Win10 DG Win7 Pro 64	3-year, Onsite	02/16
10FM002UUS	US	i5-6500T	vPro	Intel HD 530	None	4GBx1	500GB 7200rpm 2.5"	DVD±RW	8260 ac, 2x2, vPro + BT4.1	VGA	Switch	None	1Wx1	None	None	None	USB / USB	VESA Mount	None	65W Adapter 88%	Win10 DG Win7 Pro 64	3-year, Onsite	02/16
10FM002VUS	US	i5-6500T	vPro	Intel HD 530	None	4GBx1	500GB 7200rpm 2.5"	DVD±RW	8260 ac, 2x2, vPro + BT4.1	VGA	Switch	None	1Wx1	None	None	None	None / USB	VESA Mount	None	65W Adapter 88%	Win10 DG Win7 Pro 64	3-year, Onsite	02/16
10FM0030US	US	i5-6600T	vPro	Intel HD 530	None	8GBx1	128GB SSD	None	8260 ac, 2x2, vPro + BT4.1	3rd DP	Switch	None	1Wx1	None	None	None	USB / USB	None	Floor Stand	65W Adapter 88%	Win10 DG Win7 Pro 64	3-year, Onsite	03/16
10FM0031US	US	i5-6500T	vPro	Intel HD 530	None	8GBx1	128GB SSD	None	8260 ac, 2x2, vPro + BT4.1	VGA	Switch	None	1Wx1	None	None	None	USB / USB	None	Floor Stand	65W Adapter 88%	Win10 DG Win7 Pro 64	3-year, Onsite	03/16
10FM0032US	US	i5-6600T	vPro	Intel HD 530	None	8GBx1	500GB 7200rpm 2.5"	None	8260 ac, 2x2, vPro + BT4.1	3rd DP	Switch	None	1Wx1	None	None	None	USB / USB	None	Floor Stand	65W Adapter 88%	Win10 DG Win7 Pro 64	3-year, Onsite	03/16
10FM0033US	US	i7-6700T	vPro	Intel HD 530	None	8GBx1	128GB SSD	None	8260 ac, 2x2, vPro + BT4.1	HDMI	Switch	None	1Wx1	None	None	None	USB / USB	None	Floor Stand	65W Adapter 88%	Win10 Pro 64	3-year, Onsite	04/16
10FM0034US	US	i5-6500T	vPro	Intel HD 530	None	8GBx1	256GB SSD Opal	None	8260 ac, 2x2, vPro + BT4.1	3rd DP	Switch	None	1Wx1	None	None	None	USB / USB	None	Floor Stand	65W Adapter 88%	Win10 Pro 64	3-year, Onsite	04/16
10FM0039US	US	i5-6500T	vPro	Intel HD 530	None	8GBx1	500GB 7200rpm 2.5" + 128GB SSD M.2	None	8260 ac, 2x2, vPro + BT4.1	HDMI	Switch	None	1Wx1	None	None	None	USB / USB	None	Floor Stand	65W Adapter 88%	Win10 DG Win7 Pro 64	3-year, Onsite	05/16
10FM003AUS	US	i7-6700T	vPro	Intel HD 530	None	8GBx1	128GB SSD + 128GB SSD M.2 PCIe	None	8260 ac, 2x2, vPro + BT4.1	HDMI	Switch	None	1Wx1	None	None	None	USB / USB	None	Floor Stand	65W Adapter 88%	Win10 DG Win7 Pro 64	3-year, Onsite	05/16
10FM003BUS	US	i7-6700T	vPro	Intel HD 530	None	4GBx1	500GB 7200rpm 2.5"	None	8260 ac, 2x2, vPro + BT4.1	3rd DP	Switch	None	1Wx1	None	None	None	USB / USB	None	Floor Stand	65W Adapter 88%	Win10 DG Win7 Pro 64	3-year, Onsite	05/16
10FM003LUS	US	i5-6500T	vPro	Intel HD 530	None	4GBx1	500GB 7200rpm 2.5"	None	8260 ac, 2x2, vPro + BT4.1	Serial	Switch	None	1Wx1	None	None	None	USB / USB	None	Floor Stand	65W Adapter 88%	Win10 Pro 64	3-year, Onsite	07/16
10FM003YUS	US	i7-6700T	vPro	Intel HD 530	None	8GBx1	256GB SSD Opal	None	8260 ac, 2x2, vPro + BT4.1	HDMI	Switch	None	1Wx1	None	None	None	USB / USB	None	Floor Stand	65W Adapter 88%	Win10 Pro 64	3-year, Onsite	10/16

Model	Region	Processor	vPro	Graphics	Monitor Cable	Memory	Storage(HDD/SSD)	External Optical / I/O Box	WLAN + Bluetooth	Optional Rear Ports	Chassis Intrusion Switch	Kensington Cable Lock	Speaker	Adapter Cage	Toolless Chassis Screw	Dust Filter	Keyboard / Mouse	VESA Mount	Stand	Power Supply	Operating System	Warranty	Ann Date (m/y)
10NE0000US	US	i5-6500T	vPro	Intel HD 530	None	4GBx1	500GB 7200rpm 2.5"	None	8260 ac, 2x2, vPro + BT4.1	HDMI	Switch	None	1Wx1	None	None	None	USB / USB	None	Floor Stand	65W Adapter 88%	Win10 Pro 64	3-year, Onsite	07/16
10NE0001US	US	i5-6500T	vPro	Intel HD 530	None	4GBx1	500GB 7200rpm 2.5"	None	8260 ac, 2x2, vPro + BT4.1	3rd DP	Switch	None	1Wx1	None	None	None	USB / USB	None	Floor Stand	65W Adapter 88%	Win10 Pro 64	3-year, Onsite	07/16
10NE0002US	US	i5-6500T	vPro	Intel HD 530	None	8GBx1	256GB SSD Opal	None	8260 ac, 2x2, vPro + BT4.1	3rd DP	Switch	None	1Wx1	None	None	None	USB / USB	None	Floor Stand	65W Adapter 88%	Win10 Pro 64	3-year, Onsite	07/16
10NE0003US	US	i5-6500T	vPro	Intel HD 530	None	4GBx1	128GB SSD	None	8260 ac, 2x2, vPro + BT4.1	HDMI	Switch	None	1Wx1	None	None	None	USB / USB	None	Floor Stand	65W Adapter 88%	Win10 Pro 64	3-year, Onsite	07/16
10NE0004US	US	i7-6700T	vPro	Intel HD 530	None	8GBx1	128GB SSD	None	8260 ac, 2x2, vPro + BT4.1	HDMI	Switch	None	1Wx1	None	None	None	USB / USB	None	Floor Stand	65W Adapter 88%	Win10 Pro 64	3-year, Onsite	07/16
10NE0005US	US	i5-6500T	vPro	Intel HD 530	None	8GBx1	256GB SSD Opal	None	8260 ac, 2x2, vPro + BT4.1	HDMI	Switch	None	1Wx1	None	None	None	USB / USB	None	Floor Stand	65W Adapter 88%	Win10 Pro 64	3-year, Onsite	07/16
10NE000RUS	US	i7-6700T	vPro	Intel HD 530	None	8GBx1	256GB SSD Opal	None	8260 ac, 2x2, vPro + BT4.1	HDMI	Switch	None	1Wx1	None	None	None	USB / USB	None	Floor Stand	65W Adapter 88%	Win10 Pro 64	3-year, Onsite	10/16
10NE000SUS	US	i5-6500T	vPro	Intel HD 530	None	8GBx1	512GB SSD	None	8260 ac, 2x2, vPro + BT4.1	3rd DP	Switch	None	1Wx1	None	None	None	USB / USB	None	Floor Stand	65W Adapter 88%	Win10 DG Win7 Pro 64	3-year, Onsite	11/16
10NE000TUS	US	i7-6700T	vPro	Intel HD 530	None	8GBx1	512GB SSD	None	8260 ac, 2x2, vPro + BT4.1	3rd DP	Switch	None	1Wx1	None	None	None	USB / USB	None	Floor Stand	65W Adapter 88%	Win10 DG Win7 Pro 64	3-year, Onsite	11/16
10NE000UUS	US	i5-6500T	vPro	Intel HD 530	None	8GBx1	512GB SSD	None	8260 ac, 2x2, vPro + BT4.1	3rd DP	Switch	None	1Wx1	None	None	None	USB / USB	None	Floor Stand	65W Adapter 88%	Win10 Pro 64	3-year, Onsite	11/16
10NE000VUS	US	i7-6700T	vPro	Intel HD 530	None	8GBx1	512GB SSD	None	8260 ac, 2x2, vPro + BT4.1	3rd DP	Switch	None	1Wx1	None	None	None	USB / USB	None	Floor Stand	65W Adapter 88%	Win10 Pro 64	3-year, Onsite	11/16

Model	Region	Processor	vPro	Graphics	Monitor Cable	Memory	Storage(HDD/SSD)	External Optical / I/O Box	WLAN + Bluetooth	Optional Rear Ports	Chassis Intrusion Switch	Kensington Cable Lock	Speaker	Adapter Cage	Toolless Chassis Screw	Dust Filter	Keyboard / Mouse	VESA Mount	Stand	Power Supply	Operating System	Warranty	Ann Date (m/y)
10FL0003US	US	i5-6500T	vPro	Intel HD 530	None	4GBx1	500GB 7200rpm 2.5"	None	8260 ac, 2x2, vPro + BT4.1	3rd DP	Switch	None	1Wx1	None	None	None	USB / USB	None	Floor Stand	65W Adapter 88%	Win10 DG Win7 Pro 64	3-year, Onsite, OID	11/15
10FL0004US	US	i7-6700T	vPro	Intel HD 530	None	8GBx1	120GB SSD	None	8260 ac, 2x2, vPro + BT4.1	3rd DP	Switch	None	1Wx1	None	None	None	USB / USB	None	Floor Stand	65W Adapter 88%	Win10 DG Win7 Pro 64	3-year, Onsite, OID	11/15
10FL0005US	US	i5-6500T	vPro	Intel HD 530	None	4GBx1	120GB SSD	None	8260 ac, 2x2, vPro + BT4.1	3rd DP	Switch	None	1Wx1	None	None	None	USB / USB	None	Floor Stand	65W Adapter 88%	Win10 DG Win7 Pro 64	3-year, Onsite, OID	11/15
10FL0006US	US	i7-6700T	vPro	Intel HD 530	None	8GBx1	120GB SSD	DVD±RW	8260 ac, 2x2, vPro + BT4.1	HDMI	Switch	None	1Wx1	None	None	None	USB / USB	VESA Mount	None	65W Adapter 88%	Win10 DG Win7 Pro 64	3-year, Onsite, OID	11/15
10FL0007US	US	i5-6500T	vPro	Intel HD 530	None	4GBx1	500GB 7200rpm 2.5"	None	8260 ac, 2x2, vPro + BT4.1	None	Switch	None	1Wx1	None	None	None	USB / USB	None	Floor Stand	65W Adapter 88%	Win10 DG Win7 Pro 64	3-year, Onsite, OID	11/15
10FL0008US	US	i5-6500T	vPro	Intel HD 530	None	4GBx1	120GB SSD	DVD±RW	8260 ac, 2x2, vPro + BT4.1	HDMI	Switch	None	1Wx1	None	None	None	USB / USB	VESA Mount	None	65W Adapter 88%	Win10 DG Win7 Pro 64	3-year, Onsite, OID	11/15
10FL001RUS	US	i5-6600T	vPro	Intel HD 530	VGA	4GBx1	500GB 7200rpm 2.5"	None	8260 ac, 2x2 + BT4.1	VGA	Switch	None	1Wx1	None	None	None	USB / USB	None	Floor Stand	65W Adapter 88%	Win10 Pro 64	3-year, Onsite, OID	11/15
10FL001SUS	US	i5-6500T	vPro	Intel HD 530	None	4GBx1	500GB 7200rpm 2.5"	None	None	3rd DP	Switch	None	1Wx1	None	None	None	USB / USB	None	None	65W Adapter 88%	Win10 Pro 64	3-year, Onsite, OID	11/15
10FL001WUS	US	i5-6500T	vPro	Intel HD 530	None	4GBx1	500GB 7200rpm 2.5"	None	None	None	Switch	None	1Wx1	None	None	None	USB / USB	None	None	65W Adapter 88%	Win10 DG Win7 Pro 64	3-year, Onsite, OID	11/15
10FL001XUS	US	i5-6600T	vPro	Intel HD 530	None	4GBx1	500GB 7200rpm 2.5"	None	8260 ac, 2x2 + BT4.1	None	Switch	None	1Wx1	None	None	None	USB / USB	None	None	65W Adapter 88%	Win10 DG Win7 Pro 64	3-year, Onsite, OID	11/15
10FL0024US	US	i7-6700T	vPro	Intel HD 530	None	4GBx1	1TB 5400rpm 2.5"	DVD±RW	8260 ac, 2x2 + BT4.1	None	Switch	None	1Wx1	None	None	None	USB / USB	VESA Mount	None	65W Adapter 88%	Win10 Pro 64	3-year, Onsite, OID	11/15



ThinkCentre M900 Mini Tower Platform Specifications

Product Specifications Reference (PSREF)

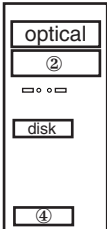
Processor	Intel® Celeron®, Intel Pentium®, or 6th Generation Intel Core™ i3 / i5 / i7 Processor							Manageability Intel Active Management Technology 11.0 (Intel AMT 11.0); Intel vPro technology on some models (require choosing a vPro-support Wi-Fi adapter to enable vPro function through wireless connection) Security chip Trusted Platform Module, TCG 1.2-compliant Security features <ul style="list-style-type: none"> • One lock to secure both cover and entire system to fixed object: <ul style="list-style-type: none"> -Padlock loop (in rear for opt padlock) -Security slot (in rear for optional Kensington® MicroSaver® cable) • Power-on password • Administrator password • Hard disk password • Boot sequence control • Boot without keyboard and mouse • Individual USB port disablement • Optional chassis intrusion switch
	Processor	Cores / Threads	Frequency Base/Max(GHz)	Cache	Memory Types	Integrated Graphics	Intel vPro	
	Pentium G4400	2 / 2	3.3G	3 MB	DDR4-2133	HD 510	No	
	Pentium G4500	2 / 2	3.5G	3 MB	DDR4-2133	HD 530	No	
	Core i3-6100	2 / 4	3.7 G	3 MB	DDR4-2133	HD 530	No	
	Core i3-6300	2 / 4	3.8 G	4 MB	DDR4-2133	HD 530	No	
	Core i5-6400	4 / 4	2.7 G / 3.3 G	6 MB	DDR4-2133	HD 530	No	
	Core i5-6500	4 / 4	3.2 G / 3.6 G	6 MB	DDR4-2133	HD 530	vPro	
Core i5-6600	4 / 4	3.3 G / 3.9 G	6 MB	DDR4-2133	HD 530	vPro		
Core i7-6700	4 / 8	3.4 G / 4.0 G	8 MB	DDR4-2133	HD 530	vPro		
Memory	64GB max, UDIMM, DDR4 2133, four 288-pin DIMM sockets, dual-channel capable							
Disk	<i>Some:</i> Hard disk, SATA 6.0Gb/s, 2.5" / 3.5" wide, 5400 / 7200 rpm <i>Some:</i> Solid State Hybrid Drive (SSHD), 500GB (5400 rpm, 2.5") / 1TB or 2TB (7200 rpm, 3.5"), with 8GB NAND flash memory, SATA 6.0Gb/s <i>Some:</i> Solid State Drive (SSD) / SATA 6.0Gb/s, 2.5" Wide <i>Some:</i> M.2 SSD, PCIe NVMe, PCIe 3.0 x4, 32Gb/s <i>Some:</i> Front accessible and removable HDD, 3.5", lockable via physical key							
Optical	<i>Some:</i> DVD-ROM SATA 1.5Gb/s Drive <i>Some:</i> Super Multi-Burner DVD±RW SATA 1.5Gb/s Drive							
Onboard SATA	Four onboard SATA 6.0Gb/s connectors, one is eSATA connector for optional rear eSATA port, RAID 0, 1 support							
Media reader	Optional 29-in-1 media reader							
Graphics	Intel HD Graphics 510/530 in processor, uses main memory, DirectX® 12, one VGA, two DisplayPort™, supports three independent displays, works along with discrete graphics to support more displays; <i>Max resolution:</i> 4096x2304 (DP) @60Hz; 1920x1200 (VGA) @60Hz <i>Some:</i> NVIDIA® Quadro® K420 , DirectX 12, 2GB, PCIe 2.0 x16 adapter, one DVI-I, one DisplayPort, 41 watts; <i>Max resolution:</i> 3840x2160 (DisplayPort) @60Hz; 2560x1600 (DVI-I) @60Hz <i>Some:</i> NVIDIA GeForce® GT 720 , DirectX 12, 2GB, PCIe 2.0 x8 adapter, one VGA, one HDMI, 25 watts; <i>Max resolution:</i> 1920x1080 (HDMI) @60Hz; 2048x1536 (VGA) @85Hz <i>Some:</i> NVIDIA GeForce GT 720 , DirectX 12, 1GB, PCIe 2.0 x8 adapter, two DisplayPort, 25 watts; <i>Max resolution:</i> 3840x2160 (DisplayPort) @60Hz;							
DP cable	Optional DP to VGA, DP to DVI-D (single link), or DP to HDMI 1.4 dongle							
Chipset	Intel Q170 Chipset							
Front ports	Two USB 3.0, two optional USB 2.0, microphone (3.5mm), headphone (3.5mm)							
Rear ports	Six USB 3.0, two optional USB 2.0, serial (9-pin), optional 2nd serial (9-pin), optional parallel (25-pin), ethernet (RJ-45), one VGA, two DisplayPort, optional PS/2 ports (keyboard/mouse), one optional eSATA port additional VGA, DisplayPort, DVI-I or HDMI on optional graphics on some models							
Rear audio ports	Line-in (3.5mm), line-out (3.5mm), microphone-in (3.5mm)							
IEEE 1394	None							
Audio support	High Definition (HD) Audio, Realtek ALC662 / optional internal speaker (1.5 watt)							
WLAN ¹³	<i>Some:</i> 11ac wireless, M.2 Card, Qualcomm Atheros QCA9377 (dual band), Wi-Fi + Bluetooth 4.1 combo adapter, 1x1 <i>Some:</i> 11ac wireless, M.2 Card, Qualcomm Atheros QCA6174 (dual band), Wi-Fi + Bluetooth 4.1 combo adapter, 2x2 <i>Some:</i> 11ac wireless, M.2 Card, Intel Dual Band Wireless-AC 3165, Wi-Fi + Bluetooth 4.0 combo adapter, 1x1 <i>Some:</i> 11ac wireless, M.2 Card, Intel Dual Band Wireless-AC 8260, Wi-Fi + Bluetooth 4.1 combo adapter, 2x2 <i>Some:</i> 11ac wireless, M.2 Card, Intel Dual Band Wireless-AC 8260, Wi-Fi + Bluetooth 4.1 combo adapter, Intel vPro technology support, 2x2							
Bluetooth™	<i>Some:</i> Bluetooth 4.0 or 4.1 wireless, integrated in Wi-Fi + BT combo adapter							
Ethernet	Gigabit ethernet, Intel Ethernet Connection I219-LM (Jacksonville), Wake on LAN®							
Modem	None							
Mechanical	<ul style="list-style-type: none"> • Mini Tower (25L), black color, metal case • (WxDxH) 6.89" X 16.26" X 15.98"; 175mm X 413mm X 406mm • 27.56 lb (12.5 kg) • Toolless cover, disk, optical removal • Toolless graphics, PCI adapter retention • Optional carry handle, dust filter 							
Power supply	<i>Some:</i> 250 watts, autosensing, 85% PSU <i>Some:</i> 400 watts, autosensing, 92% PSU (available only via Special Bid)							
Limited warranty ³	<i>Some:</i> 1-year or 3-year, limited onsite service / service upgrades available <i>Some:</i> 3-year, limited onsite service, OID (Onsite International Delivery) / service upgrades available <i>For Lenovo service upgrade options, please go to S-TC sheet</i>							
Preload	Preloaded operating system		Preloaded applications (only some listed)					
	<i>Some:</i> Windows® 7 Professional 64 preinstalled through downgrade rights in Windows 10 Pro 64-bit <i>Some:</i> Windows 7 Professional 64 <i>Some:</i> Windows 10 Pro 64-bit <i>Some:</i> Windows 10 Home 64-bit		<ul style="list-style-type: none"> • Desktop Power Manager • Lenovo Solution Center • Lenovo REACHit • Lenovo SHAREit • Lenovo Bluetooth Lock (for models with Wi-Fi/BT card) • McAfee® LiveSafe™ (30-day trial) • Microsoft Office preloaded; purchase a product key to activate • PowerDVD Create (DVD±RW) • Lenovo ThinkVantage Tools • Intel Unite (vPro models only) - Only for Window 10 • Lenovo Companion • Cyberlink PowerDVD (DVD, DVD±RW) • Lenovo QuickOptimizer - Only for Window 7 • Rescue and Recovery • Password Manager • ThinkVantage System Update • Lenovo Message Center Plus • Adobe® Reader® 					
Environment	ENERGY STAR® 6.1*; EPEAT™ Gold rating*; (*Need 85% PSU and Windows OS); ErP Lot 3; GREENGUARD®; RoHS-compliant; TUV Green Mark, ULE Gold							
Accessories	For compatible accessories, please go to TC-AQP sheet							

See footnotes for more detailed information

Model	Region	Processor	vPro	Graphics	Monitor Cable	Memory	Storage(HDD/SSD)	Optical	Optional 2nd 3.5" Tray	Media Reader	WLAN + Bluetooth	Optional Front Ports	Optional Rear Ports	Chassis Intrusion Switch	Cable Lock	Front Access HDD	PCI Slot	Dust Filter	Keyboard / Mouse	Carry Handle	Power Supply	Operating System	Warranty	Ann Date (m/y)	
10FD0007US	US	i7-6700	vPro	Intel HD 530	None	8GBx1	1TB 7200rpm 3.5"	DVD±RW	None	None	None	None	None	None	None	None	None	None	None	USB / USB	Carry Handle	250W 85%	Win10 DG Win7 Pro 64	3-year, Onsite, OID	11/15
10FD0008US	US	i5-6500	vPro	Intel HD 530	None	4GBx1	500GB 7200rpm 3.5"	DVD±RW	None	None	None	None	None	None	None	None	None	None	None	USB / USB	Carry Handle	250W 85%	Win10 DG Win7 Pro 64	3-year, Onsite, OID	11/15
10FD001WUS	US	i7-6700	vPro	Intel HD 530	None	8GBx1	1TB 7200rpm 3.5"	DVD±RW	Optional 2nd 3.5" Tray	None	None	None	None	None	None	None	None	None	None	USB / USB	Carry Handle	250W 85%	Win10 Pro 64	3-year, Onsite	11/15
10FD001XUS	US	i7-6700	vPro	Intel HD 530	None	8GBx1	1TB 7200rpm 3.5"	DVD±RW	Optional 2nd 3.5" Tray	None	None	None	None	None	None	None	None	None	None	USB / USB	Carry Handle	250W 85%	Win10 DG Win7 Pro 64	3-year, Onsite	11/15
10FD001YUS	US	i5-6500	vPro	Intel HD 530	None	4GBx1	500GB 7200rpm 3.5"	DVD±RW	Optional 2nd 3.5" Tray	None	None	None	None	None	None	None	None	None	None	USB / USB	Carry Handle	250W 85%	Win10 DG Win7 Pro 64	3-year, Onsite	11/15
10FD0020US	US	i5-6500	vPro	Intel HD 530	None	4GBx1	500GB 7200rpm 3.5"	DVD±RW	Optional 2nd 3.5" Tray	None	None	None	None	None	None	None	None	None	None	USB / USB	Carry Handle	250W 85%	Win10 Pro 64	3-year, Onsite	11/15
10FD0021US	US	i5-6500	vPro	Intel HD 530	None	8GBx1	500GB 7200rpm 3.5"	DVD±RW	Optional 2nd 3.5" Tray	None	None	None	None	None	None	None	None	None	None	USB / USB	Carry Handle	250W 85%	Win10 Pro 64	3-year, Onsite	11/15
10FD0022US	US	i5-6500	vPro	Intel HD 530	None	8GBx1	500GB 7200rpm 3.5"	DVD±RW	Optional 2nd 3.5" Tray	None	None	None	None	None	None	None	None	None	None	USB / USB	Carry Handle	250W 85%	Win10 DG Win7 Pro 64	3-year, Onsite	11/15
10FD0024US	US	i5-6500	vPro	Intel HD 530	None	4GBx1	128GB SSD	DVD±RW	Optional 2nd 3.5" Tray	None	None	None	None	None	None	None	None	None	None	USB / USB	Carry Handle	250W 85%	Win10 Pro 64	3-year, Onsite	12/15
10FD0025US	US	i5-6500	vPro	Intel HD 530	None	8GBx1	256GB SSD Opal	DVD±RW	Optional 2nd 3.5" Tray	None	None	None	None	None	None	None	None	None	None	USB / USB	Carry Handle	250W 85%	Win10 DG Win7 Pro 64	3-year, Onsite	12/15
10FD0026US	US	i7-6700	vPro	GT 720 1GB	None	8GBx1	256GB SSD Opal	DVD±RW	Optional 2nd 3.5" Tray	None	None	None	None	None	None	None	None	None	None	USB / USB	Carry Handle	250W 85%	Win10 DG Win7 Pro 64	3-year, Onsite	12/15
10FD0027US	US	i7-6700	vPro	GT 720 1GB	None	8GBx1	1TB 7200rpm 3.5"	DVD±RW	Optional 2nd 3.5" Tray	None	None	None	None	None	None	None	None	None	None	USB / USB	Carry Handle	250W 85%	Win10 Pro 64	3-year, Onsite	12/15
10FD0028US	US	i7-6700	vPro	Intel HD 530	None	8GBx1	256GB SSD Opal	DVD±RW	Optional 2nd 3.5" Tray	None	None	None	None	None	None	None	None	None	None	USB / USB	Carry Handle	250W 85%	Win10 DG Win7 Pro 64	3-year, Onsite	12/15
10FD0029US	US	i5-6500	vPro	GT 720 1GB	None	4GBx1	500GB 7200rpm 3.5"	DVD±RW	Optional 2nd 3.5" Tray	None	None	None	None	None	None	None	None	None	None	USB / USB	Carry Handle	250W 85%	Win10 DG Win7 Pro 64	3-year, Onsite	12/15
10FD002AUS	US	i5-6500	vPro	Intel HD 530	None	4GBx1	180GB SSD Opal	DVD±RW	Optional 2nd 3.5" Tray	None	None	None	None	None	None	None	None	None	None	USB / USB	Carry Handle	250W 85%	Win10 DG Win7 Pro 64	3-year, Onsite	12/15
10FD002BUS	US	i7-6700	vPro	GT 720 1GB	None	8GBx1	1TB 7200rpm 3.5"	DVD±RW	Optional 2nd 3.5" Tray	None	None	None	None	None	None	None	None	None	None	USB / USB	Carry Handle	250W 85%	Win10 DG Win7 Pro 64	3-year, Onsite	12/15
10FD002CUS	US	i7-6700	vPro	Intel HD 530	None	8GBx1	256GB SSD Opal	DVD±RW	Optional 2nd 3.5" Tray	None	None	None	None	None	None	None	None	None	None	USB / USB	Carry Handle	250W 85%	Win10 Pro 64	3-year, Onsite	12/15
10FD002DUS	US	i5-6500	vPro	Intel HD 530	None	4GBx1	128GB SSD	DVD±RW	Optional 2nd 3.5" Tray	None	None	None	None	None	None	None	None	None	None	USB / USB	Carry Handle	250W 85%	Win10 DG Win7 Pro 64	3-year, Onsite	12/15
10FD002EUS	US	i5-6500	vPro	Intel HD 530	None	8GBx1	180GB SSD Opal	DVD±RW	Optional 2nd 3.5" Tray	None	None	None	None	None	None	None	None	None	None	USB / USB	Carry Handle	250W 85%	Win10 Pro 64	3-year, Onsite	12/15
10FD002FUS	US	i5-6500	vPro	GT 720 1GB	None	8GBx1	1TB 7200rpm 3.5"	DVD±RW	Optional 2nd 3.5" Tray	None	None	None	None	None	None	None	None	None	None	USB / USB	Carry Handle	250W 85%	Win10 DG Win7 Pro 64	3-year, Onsite	12/15

Model	Region	Processor	vPro	Graphics	Monitor Cable	Memory	Storage(HDD/SSD)	Optical	Optional 2nd 3.5" Tray	Media Reader	WLAN + Bluetooth	Optional Front Ports	Optional Rear Ports	Chassis Intrusion Switch	Cable Lock	Front Access HDD	PCI Slot	Dust Filter	Keyboard / Mouse	Carry Handle	Power Supply	Operating System	Warranty	Ann Date (m/y)	
10FD002GUS	US	i5-6500	vPro	Intel HD 530	None	4GBx1	192GB SSD	DVD±RW	Optional 2nd 3.5" Tray	None	None	None	None	None	None	None	None	None	None	USB / USB	Carry Handle	250W 85%	Win10 DG Win7 Pro 64	3-year, Onsite	12/15
10FD002HUS	US	i5-6500	vPro	GT 720 1GB	None	8GBx1	1TB 7200rpm 3.5"	DVD±RW	Optional 2nd 3.5" Tray	None	None	None	None	None	None	None	None	None	None	USB / USB	Carry Handle	250W 85%	Win10 Pro 64	3-year, Onsite	12/15
10FD003PUS	US	i7-6700	vPro	GT 720 1GB	None	8GBx1	256GB SSD Opal	DVD±RW	Optional 2nd 3.5" Tray	None	None	None	None	None	None	None	None	None	None	USB / USB	Carry Handle	250W 85%	Win10 Pro 64	3-year, Onsite	10/16
10FD003QUS	US	i7-6700	vPro	GT 720 1GB	None	8GBx1	1TB 7200rpm 3.5"	DVD±RW	Optional 2nd 3.5" Tray	None	None	None	None	None	None	None	None	None	None	USB / USB	Carry Handle	250W 85%	Win10 DG Win7 Pro 64	3-year, Onsite	10/16
10FD003RUS	US	i7-6700	vPro	GT 720 1GB	None	8GBx1	1TB 7200rpm 3.5"	DVD±RW	Optional 2nd 3.5" Tray	None	None	None	None	None	None	None	None	None	None	USB / USB	Carry Handle	250W 85%	Win10 Pro 64	3-year, Onsite	10/16
10FD003SUS	US	i5-6500	vPro	GT 720 1GB	None	4GBx1	500GB 7200rpm 3.5"	DVD±RW	Optional 2nd 3.5" Tray	None	None	None	None	None	None	None	None	None	None	USB / USB	Carry Handle	250W 85%	Win10 Pro 64	3-year, Onsite	10/16
10FD003TUS	US	i7-6700	vPro	GT 720 1GB	None	8GBx1	256GB SSD Opal	DVD±RW	Optional 2nd 3.5" Tray	None	None	None	None	None	None	None	None	None	None	USB / USB	Carry Handle	250W 85%	Win10 DG Win7 Pro 64	3-year, Onsite	10/16
10FD003UUS	US	i5-6500	vPro	GT 720 1GB	None	4GBx1	500GB 7200rpm 3.5"	DVD±RW	Optional 2nd 3.5" Tray	None	None	None	None	None	None	None	None	None	None	USB / USB	Carry Handle	250W 85%	Win10 DG Win7 Pro 64	3-year, Onsite	10/16
10FD003VUS	US	i5-6500	vPro	GT 720 1GB	None	8GBx1	1TB 7200rpm 3.5"	DVD±RW	Optional 2nd 3.5" Tray	None	None	None	None	None	None	None	None	None	None	USB / USB	Carry Handle	250W 85%	Win10 Pro 64	3-year, Onsite	10/16
10FD003WUS	US	i5-6500	vPro	GT 720 1GB	None	8GBx1	1TB 7200rpm 3.5"	DVD±RW	Optional 2nd 3.5" Tray	None	None	None	None	None	None	None	None	None	None	USB / USB	Carry Handle	250W 85%	Win10 DG Win7 Pro 64	3-year, Onsite	10/16

ThinkCentre M900 Tower - 10FC

Product Specifications Reference (PSREF)

Model	Region	Processor	vPro	Graphics	Monitor Cable	Memory	Storage(HDD/SSD)	Optical	Optional 2nd 3.5" Tray	Media Reader	WLAN + Bluetooth	Optional Front Ports	Optional Rear Ports	Chassis Intrusion Switch	Cable Lock	Front Access HDD	PCI Slot	Dust Filter	Keyboard / Mouse	Carry Handle	Power Supply	Operating System	Warranty	Ann Date (m/y)	
10FC0003US	US	i5-6500	vPro	Intel HD 530	None	4GBx1	500GB 7200rpm 3.5"	DVD±RW	None	None	None	None	None	None	None	None	None	None	None	USB / USB	None	250W 85%	Win10 Pro 64	3-year, Onsite, OID	11/15
10FC0004US	US	i5-6500	vPro	Intel HD 530	None	4GBx1	500GB 7200rpm 3.5"	DVD±RW	None	None	None	None	None	None	None	None	None	None	None	USB / USB	None	250W 85%	Win10 DG Win7 Pro 64	3-year, Onsite, OID	11/15
10FC0005US	US	i7-6700	vPro	Intel HD 530	None	8GBx1	1TB 7200rpm 3.5"	DVD±RW	None	None	None	None	None	None	None	None	None	None	None	USB / USB	None	250W 85%	Win10 DG Win7 Pro 64	3-year, Onsite, OID	11/15
10FC0006US	US	i7-6700	vPro	Intel HD 530	None	8GBx1	1TB 7200rpm 3.5"	DVD±RW	None	None	None	None	None	None	None	None	None	None	None	USB / USB	None	250W 85%	Win10 Pro 64	3-year, Onsite, OID	11/15
10FC000BUS	US	i5-6600	vPro	Intel HD 530	None	4GBx1	500GB 7200rpm 3.5"	DVD±RW	None	None	None	None	None	None	None	None	None	None	None	USB / USB	Carry Handle	250W 85%	Win10 Pro 64	3-year, Onsite, OID	11/15
10FC000GUS	US	i5-6500	vPro	Intel HD 530	None	4GBx1	500GB 7200rpm 3.5"	DVD	None	None	None	None	None	None	None	None	None	None	None	USB / USB	Carry Handle	250W 85%	Win10 Pro 64	3-year, Onsite, OID	11/15
10FC000HUS	US	i7-6700	vPro	GT 720 1GB	None	4GBx1	1TB 7200rpm 3.5"	DVD±RW	None	29-in-1	None	None	None	None	None	None	None	None	None	USB / USB	Carry Handle	250W 85%	Win10 Pro 64	3-year, Onsite, OID	11/15
10FC000KUS	US	i5-6600	vPro	Intel HD 530	None	4GBx1	500GB 7200rpm 3.5"	DVD±RW	None	None	None	None	None	None	None	None	None	None	None	USB / USB	None	250W 85%	Win10 DG Win7 Pro 64	3-year, Onsite, OID	11/15
10FC000LUS	US	i7-6700	vPro	GT 720 1GB	None	4GBx1	1TB 7200rpm 3.5"	DVD±RW	None	29-in-1	None	None	None	None	None	None	None	Dust Filter	USB / USB	Carry Handle	250W 85%	Win10 DG Win7 Pro 64	3-year, Onsite, OID	11/15	
10FC000MUS	US	i5-6500	vPro	Intel HD 530	None	4GBx1	500GB 7200rpm 3.5"	DVD	None	None	None	None	None	None	None	None	None	None	None	USB / USB	None	250W 85%	Win10 DG Win7 Pro 64	3-year, Onsite, OID	11/15



ThinkCentre M900x Tiny Platform Specifications

Product Specifications Reference (PSREF)

Processor	Intel® Celeron®, Intel Pentium®, or 6th Generation Intel Core™ i3 / i5 / i7 Processor	Security features	<ul style="list-style-type: none"> Security slot (in rear for optional Kensington® MicroSaver® cable) Administrator password Padlock loop Hard disk password Smart USB protection, allows keyboard/mouse only, blocks all storage devices Boot sequence control Power-on password Boot without keyboard and mouse Individual USB port disablement Chassis intrusion switch 																																																	
	<table border="1"> <thead> <tr> <th>Processor</th> <th>Cores / Threads</th> <th>Frequency Base/Max(GHz)</th> <th>Cache</th> <th>Memory Types</th> <th>Integrated Graphics</th> <th>Intel vPro</th> </tr> </thead> <tbody> <tr> <td>Core i3-6100</td> <td>2 / 4</td> <td>3.7 G</td> <td>3 MB</td> <td>DDR4-2133</td> <td>HD 530</td> <td>No</td> </tr> <tr> <td>Core i3-6300</td> <td>2 / 4</td> <td>3.8 G</td> <td>4 MB</td> <td>DDR4-2133</td> <td>HD 530</td> <td>No</td> </tr> <tr> <td>Core i5-6400</td> <td>4 / 4</td> <td>2.7 G / 3.3 G</td> <td>6 MB</td> <td>DDR4-2133</td> <td>HD 530</td> <td>No</td> </tr> <tr> <td>Core i5-6500</td> <td>4 / 4</td> <td>3.2 G / 3.6 G</td> <td>6 MB</td> <td>DDR4-2133</td> <td>HD 530</td> <td>vPro</td> </tr> <tr> <td>Core i5-6600</td> <td>4 / 4</td> <td>3.3 G / 3.9 G</td> <td>6 MB</td> <td>DDR4-2133</td> <td>HD 530</td> <td>vPro</td> </tr> <tr> <td>Core i7-6700</td> <td>4 / 8</td> <td>3.4 G / 4.0 G</td> <td>8 MB</td> <td>DDR4-2133</td> <td>HD 530</td> <td>vPro</td> </tr> </tbody> </table>	Processor	Cores / Threads	Frequency Base/Max(GHz)	Cache	Memory Types	Integrated Graphics	Intel vPro	Core i3-6100	2 / 4	3.7 G	3 MB	DDR4-2133	HD 530	No	Core i3-6300	2 / 4	3.8 G	4 MB	DDR4-2133	HD 530	No	Core i5-6400	4 / 4	2.7 G / 3.3 G	6 MB	DDR4-2133	HD 530	No	Core i5-6500	4 / 4	3.2 G / 3.6 G	6 MB	DDR4-2133	HD 530	vPro	Core i5-6600	4 / 4	3.3 G / 3.9 G	6 MB	DDR4-2133	HD 530	vPro	Core i7-6700	4 / 8	3.4 G / 4.0 G	8 MB	DDR4-2133	HD 530	vPro	Keyboard	<i>Some:</i> Preferred Pro USB Keyboard (USB connector), Lenovo logo <i>Some:</i> Lenovo USB Fingerprint Keyboard (USB connector) <i>Some:</i> Ultralim Plus Wireless Keyboard (2.4GHz via USB receiver), black <i>Some:</i> Enhanced Optical USB Mouse, black, Lenovo logo <i>Some:</i> Ultralim Plus Wireless Mouse (2.4GHz via USB receiver), black
Processor	Cores / Threads	Frequency Base/Max(GHz)	Cache	Memory Types	Integrated Graphics	Intel vPro																																														
Core i3-6100	2 / 4	3.7 G	3 MB	DDR4-2133	HD 530	No																																														
Core i3-6300	2 / 4	3.8 G	4 MB	DDR4-2133	HD 530	No																																														
Core i5-6400	4 / 4	2.7 G / 3.3 G	6 MB	DDR4-2133	HD 530	No																																														
Core i5-6500	4 / 4	3.2 G / 3.6 G	6 MB	DDR4-2133	HD 530	vPro																																														
Core i5-6600	4 / 4	3.3 G / 3.9 G	6 MB	DDR4-2133	HD 530	vPro																																														
Core i7-6700	4 / 8	3.4 G / 4.0 G	8 MB	DDR4-2133	HD 530	vPro																																														
Memory	32GB max, DDR4 2133, two 260-pin SO-DIMM sockets, dual-channel capable	Mouse																																																		
Disk	<i>Some:</i> SATA 6.0Gb/s, 2.5" Wide, 5400 rpm or 7200 rpm <i>Some:</i> 500GB (5400 rpm) Solid State Hybrid Drive (SSHD) / with 8GB MLC NAND flash memory, SATA 6.0Gb/s, 2.5" wide <i>Some:</i> Solid State Drive (SSD) / SATA 6.0Gb/s, 2.5" Wide <i>Some:</i> M.2 SSD, PCIe or SATA interface	Mechanical	Tiny (1L), black color; metal case M900x Tiny only: 7.05" W X 7.20" D X 1.36" H 179mm W X 182.9mm D X 34.5mm H 2.9 lb (1.3 kg), weight may vary by configuration With VESA mount & ODD box: 7.42" W X 7.30" D X 2.48" H 188.4mm W X 185.38mm D X 63mm H 4.12 lb (1.87 kg), weight may vary by configuration With VESA mount & I/O box: 7.42" W X 7.30" D X 2.62" H 188.4mm W X 185.38mm D X 66.6mm H 3.53 lb (1.6 kg), weight may vary by configuration Optional VESA mount bracket kit, supports VESA 75mm and 100mm Optional system floor stand for vertical orientation																																																	
Optical	<i>Some:</i> external ODD box with DVD-ROM, 9.5mm high, via USB <i>Some:</i> external ODD box with DVD±RW, 9.5mm high, via USB <i>Some:</i> external ODD box (for TIO) with DVD-ROM, 9.5mm high, via USB <i>Some:</i> external ODD box (for TIO) with DVD±RW, 9.5mm high, via USB <i>One:</i> SATA cable (1-drop to device), one SATA 6.0Gb/s connector on planar	VESA mount																																																		
Onboard SATA Media reader	None	Floor Stand																																																		
Graphics	Intel HD Graphics 510/530 in processor, uses main memory, DirectX® 12, two DisplayPort™, one optional HDMI, VGA, or 3rd DP, up to 3 independent displays; <i>Max resolution:</i> 4096x2304 (DP) @60Hz; 4096x2160 (HDMI) @24Hz; 1920x1200 (VGA) @60Hz	Power supply	135 watts AC/DC adapter, autosensing, 88% PSU																																																	
DP cable	Optional DP to VGA, DP to DVI-D (single link), or DP to HDMI 1.4 dongle	Limited warranty ³	<i>Some:</i> 1-year or 3-year, depot service / service upgrades available <i>Some:</i> 1-year or 3-year, limited onsite service / service upgrades available <i>Some:</i> 3-year, limited onsite service, OID (Onsite International Delivery) / service upgrades available <i>For Lenovo service upgrade options, please go to S-TC sheet</i>																																																	
Chipset	Intel Q170 Chipset	Preload	Preloaded operating system <i>Some:</i> Windows® 7 Professional 64 preinstalled through downgrade rights in Windows 10 Pro 64-bit <i>Some:</i> Windows 7 Professional 64 <i>Some:</i> Windows 10 Pro 64-bit Preloaded applications (only some listed) <ul style="list-style-type: none"> Desktop Power Manager Lenovo Solution Center Lenovo REACHit Lenovo SHAREit Lenovo Bluetooth Lock (for models with Wi-Fi/BT card) McAfee® LiveSafe™ (30-day trial) Microsoft Office preloaded; purchase a product key to activate PowerDVD Create (DVD±RW) Lenovo ThinkVantage Tools Intel Unite (vPro models only) - Only for Window 10 Lenovo Companion Cyberlink PowerDVD (DVD, DVD±RW) Lenovo QuickOptimizer - Only for Window 7 Rescue and Recovery Password Manager ThinkVantage System Update Lenovo Message Center Plus Adobe® Reader® 																																																	
Front ports	Two USB 3.0 (one is Always On and fast charge), one microphone (stereo, 3.5mm), one headphone / microphone combo jack (stereo, 3.5mm)	Environment	ENERGY STAR® 6.1*; EPEAT™ Gold rating*; (*Need 85% PSU and Windows OS); ErP Lot 3; GREENGUARD®; RoHS-compliant																																																	
Rear ports	Four USB 3.0 (optional external optical box or external I/O box occupies one or two specific USB 3.0 on some models), ethernet (RJ-45), two DisplayPort, one optional port (VGA, 3rd DP, HDMI, or serial on some models), one headphone	Accessories	For compatible accessories, please go to TC-AQP sheet																																																	
I/O box	Optional external I/O box, extends two USB 2.0, two USB 3.0, and one serial on rear, two USB 2.0 on front, via USB (occupy two specific USB 3.0 of M900x Tiny)																																																			
Audio support	High Definition (HD) Audio, Realtek ALC223 / optional internal speaker (1 watt)																																																			
WLAN ¹³	<i>Some:</i> 11ac wireless, M.2 Card, Qualcomm Atheros QCA9377 (dual band), Wi-Fi + Bluetooth 4.1 combo adapter, 1x1 <i>Some:</i> 11ac wireless, M.2 Card, Qualcomm Atheros QCA6174 (dual band), Wi-Fi + Bluetooth 4.1 combo adapter, 2x2 <i>Some:</i> 11ac wireless, M.2 Card, Intel Dual Band Wireless-AC 3165, Wi-Fi + Bluetooth 4.0 combo adapter, 1x1 <i>Some:</i> 11ac wireless, M.2 Card, Intel Dual Band Wireless-AC 8260, Wi-Fi + Bluetooth 4.1 combo adapter, 2x2 <i>Some:</i> 11ac wireless, M.2 Card, Intel Dual Band Wireless-AC 8260, Wi-Fi + Bluetooth 4.1 combo adapter, Intel vPro technology support, 2x2																																																			
Bluetooth™	<i>Some:</i> Bluetooth 4.0 or 4.1 wireless, integrated in Wi-Fi + BT combo adapter																																																			
Ethernet	Gigabit ethernet, Intel Ethernet Connection I219-LM (Jacksonville), Wake on LAN®																																																			
Modem	None																																																			
Manageability	Intel Active Management Technology 11.0 (Intel AMT 11.0); Intel vPro technology on some models (require choosing a vPro-support Wi-Fi adapter to enable vPro function through wireless connection)																																																			
Security chip	Trusted Platform Module, TCG 1.2-compliant																																																			

See footnotes for more detailed information

ThinkCentre M900x Tiny - TopSeller - 10LX

Product Specifications Reference (PSREF)

Model	Region	Processor	vPro	Graphics	Monitor Cable	Memory	Storage(HDD/SSD)	External Optical / I/O Box	WLAN + Bluetooth	Optional Rear Ports	Chassis Intrusion Switch	Kensington Cable Lock	Speaker	Adapter Cage	Toolless Chassis Screw	Dust Filter	Keyboard / Mouse	VESA Mount	Stand	Power Supply	Operating System	Warranty	Ann Date (mm/yy)
10LX0002US	US	i7-6700	vPro	Intel HD 530	None	8GBx1	128GB SSD	None	8260 ac, 2x2, vPro + BT4.1	3rd DP	Switch	None	1Wx1	None	None	None	USB / USB	None	Floor Stand	135W Adapter 88%	Win10 Pro 64	3-year, Onsite	07/16
10LX0003US	US	i5-6500	vPro	Intel HD 530	None	4GBx1	500GB 7200rpm 2.5"	None	8260 ac, 2x2, vPro + BT4.1	VGA	Switch	None	1Wx1	None	None	None	USB / USB	None	Floor Stand	135W Adapter 88%	Win10 Pro 64	3-year, Onsite	07/16
10LX0004US	US	i5-6500	vPro	Intel HD 530	None	4GBx1	500GB 7200rpm 2.5"	None	8260 ac, 2x2, vPro + BT4.1	3rd DP	Switch	None	1Wx1	None	None	None	USB / USB	None	Floor Stand	135W Adapter 88%	Win10 Pro 64	3-year, Onsite	07/16
10LX0005US	US	i5-6500	vPro	Intel HD 530	None	4GBx1	500GB 7200rpm 2.5"	None	8260 ac, 2x2, vPro + BT4.1	None	Switch	None	1Wx1	None	None	None	USB / USB	None	Floor Stand	135W Adapter 88%	Win10 Pro 64	3-year, Onsite	07/16
10LX0006US	US	i5-6500	vPro	Intel HD 530	None	8GBx1	128GB SSD	None	8260 ac, 2x2, vPro + BT4.1	3rd DP	Switch	None	1Wx1	None	None	None	USB / USB	None	Floor Stand	135W Adapter 88%	Win10 Pro 64	3-year, Onsite	07/16
10LX0007US	US	i7-6700	vPro	Intel HD 530	None	8GBx1	256GB SSD Opal	None	8260 ac, 2x2, vPro + BT4.1	3rd DP	Switch	None	1Wx1	None	None	None	USB / USB	None	Floor Stand	135W Adapter 88%	Win10 DG Win7 Pro 64	3-year, Onsite	09/16
10LX0008US	US	i5-6500	vPro	Intel HD 530	None	8GBx1	256GB SSD Opal	None	8260 ac, 2x2, vPro + BT4.1	3rd DP	Switch	None	1Wx1	None	None	None	USB / USB	None	Floor Stand	135W Adapter 88%	Win10 DG Win7 Pro 64	3-year, Onsite	09/16
10LX0009US	US	i5-6500	vPro	Intel HD 530	None	4GBx1	500GB 7200rpm 2.5"	None	8260 ac, 2x2, vPro + BT4.1	VGA	Switch	None	1Wx1	None	None	None	USB / USB	None	Floor Stand	135W Adapter 88%	Win10 DG Win7 Pro 64	3-year, Onsite	09/16
10LX000AUS	US	i5-6500	vPro	Intel HD 530	None	4GBx1	500GB 7200rpm 2.5"	None	8260 ac, 2x2, vPro + BT4.1	None	Switch	None	1Wx1	None	None	None	USB / USB	None	Floor Stand	135W Adapter 88%	Win10 DG Win7 Pro 64	3-year, Onsite	09/16
10LX000BUS	US	i5-6500	vPro	Intel HD 530	None	4GBx1	500GB 7200rpm 2.5"	None	8260 ac, 2x2, vPro + BT4.1	3rd DP	Switch	None	1Wx1	None	None	None	USB / USB	None	Floor Stand	135W Adapter 88%	Win10 DG Win7 Pro 64	3-year, Onsite	09/16
10LX000CUS	US	i5-6500	vPro	Intel HD 530	None	8GBx1	128GB SSD	None	8260 ac, 2x2, vPro + BT4.1	3rd DP	Switch	None	1Wx1	None	None	None	USB / USB	None	Floor Stand	135W Adapter 88%	Win10 DG Win7 Pro 64	3-year, Onsite	09/16
10LX000DUS	US	i7-6700	vPro	Intel HD 530	None	8GBx1	128GB SSD	None	8260 ac, 2x2, vPro + BT4.1	3rd DP	Switch	None	1Wx1	None	None	None	USB / USB	None	Floor Stand	135W Adapter 88%	Win10 DG Win7 Pro 64	3-year, Onsite	09/16



ThinkCentre Tiny-in-One (TIO) 22

Product Specifications Reference (PSREF)

Model	10LKPAR6++ / 10LKPAT6++		
Form factor	Tiny-in-One, offers a full All-In-One experience when optional Tiny slots into the back of TIO 22, clean cabling and effortless setup		
Compatible Tiny:	M900 Tiny, M700 Tiny, M600 Tiny, M93/p Tiny*, M83 Tiny, M73 Tiny*, or M53 Tiny, Chromebox * Non-TIO models can't be turned on by pressing power button of TIO 22		
Panel	TFT-LCD, In-Plane Switching (IPS), White LED backlight		
Viewable image size	21.5" (546.1mm) diagonal		
Max view area (W x H)	18.74" x 10.54" / 476.06mm x 267.79mm		
Bezel Width	Top / Side: 2mm, Bottom: 16.3mm		
Optimum resolution	1920x1080		
Aspect ratio	16:9		
Pixel pitch (mm)	0.24795mm		
Dot/Pixel per Inch	102.4 dpi		
Brightness	250 nits or cd/m ² (typical)		
Contrast ratio	1000:1 (typical)		
Pixel response time	7ms		
Color gamut	72%		
Anti-reflective	Anti-glare		
Viewing angle at 10:1 CR	178° (+/- 89°) horizontal, 178° (+/- 89°) vertical		
Preset resolutions	640x350 @ 70Hz 640x480 @ 60Hz, 66Hz, 72Hz, 75Hz 720x400 @ 70Hz 800x600 @ 60Hz, 72Hz, 75Hz 1024x768 @ 60Hz, 70Hz, 75Hz 1152x864 @ 75Hz 1280x800 @ 60Hz 1280x1024 @ 60Hz, 72Hz, 75Hz 1366x768 @ 60Hz 1440x900 @ 60Hz, 75Hz 1600x1200 @ 60Hz, 70Hz, 75Hz 1680x1050 @ 60Hz 1920x1080 @ 60Hz		
Presets / user settings	Presets: 25; user settings: 25		
On screen display	On screen display with digital user controls (8 languages)		
Control features	Mode-switching (TIO mode / standalone monitor mode, switches video / audio / USB input sources) / Back button, Left shift button, Right shift / Brightness button, Selection button / Menu button, Power button		
Tiny-in-One Power On	Pressing Alt + P on keyboard or pressing Power button positioned on TIO can turn on both TIO and Tiny (only some Tiny support, see compatible list)		
Front ports	Two USB 3.0 or two USB 2.0 (when M73 or M53 installed or USB 2.0 connected via USB upstream port), one headphone / microphone combo jack (3.5mm) * The USB ports are only available when a Tiny is installed or a PC is connected via USB upstream port		
Side ports	Side ports offered by installed Tiny (optional)		
Rear ports	One DisplayPort 1.2 port, one USB upstream port, one power connector		
3-in-1 Cable	Undetachable 3-in-1 cable (Power connector, USB 3.0 [supports USB 3.0/USB 2.0], DisplayPort 1.2), only for connecting to Tiny installed (optional)		
Internal Speaker	1.5 watt x1		
Security	Security keyhole for attachment of optional cable lock (Kensington® lock compatible), locks optional Tiny with TIO 22 together, more security features offered by Tiny installed (optional)		
Mechanical	Dimensions	TIO 22 without stand	TIO 22 with stand
	W x D x H (inch)	19.25 x 2.65 x 12.47	19.25 x 9.90 x 14.02 - 18.35
	W x D x H (mm)	489.06 x 67.2 x 316.78	489.06 x 251.4 x 356.07 - 466.07
	Weight (approximately)	11.27 lb /5.11 kg (with stand)	
Mounting features	Wall or desk mounting using the extend arm or third-party accessories meeting the VESA FPMPMI® (100mm mount)		
Adjustable stand	Tilt: 35° back, -5° forward; lift: 4.3" (110mm); swivel: +/-45°		
Power supply	90 watts AC/DC adapter, 88% PSU, universal		
Power consumption	15.57 watts typical, 35 watts maximum, <0.5 watts standby / suspend		
Limited warranty ³	3-years , Customer Carry-In or Mail-In via Rapid Replacement Service		
VESA-compliant ²	VESA DDC2B/CI, VESA DPMS-compliant		
Ergonomics	ISO 9241-307		
Emission standards	FCC Class B		
Environmental	TCO 7.0, TCO Edge 2.0, WEEE, RoHS, ENERGY STAR® 7.0 EPEAT™ Gold rating, ULE Gold, TUV, VOC		
Windows certifications	Windows 7, Windows 8/8.1, and Windows 10 certified		
Ship group	TIO 22 (Monitor), detachable stand, AC/DC power adapter, power cord, user's guide and driver CD, quick start and safety poster		
Accessories	For compatible accessories, please go to http://www.lenovoquickpick.com		
ThinkCentre Tiny-in-One 22 Compatible list			
Model	M900 Tiny, M700 Tiny, M600 Tiny, M83 Tiny, M53 Tiny	M93/p Tiny, M73 Tiny	Chromebox
Turn on TIO and Tiny together via Alt + P on USB KB	All models	All models	Not support
Turn on TIO and Tiny together via TIO Power Button	All models	TIO models	All models

See footnotes for more detailed information

Model	Region	Color	Display Size	Resolution	Aspect Ratio	Pixel Pitch	Dot / Pixel Per Inch	Brightness	Contrast Ratio	Pixel Response Time	Color Gamut	View Angle (H / V)	Stand	Power Consumption (Typical / Maximum)	Power Supply	Warranty	Ann Date (mm/yy)
10LKPAR6US	US	Black	21.5"	1920x1080	16:9	0.24795mm	102.4 dpi	250 nits	1000:1	7 ms	72%	178 / 178	Adjustable Stand	15.57W / 35W	90W 88% Adapter	3-year	04/16
10LKPAT6US	US	Black	21.5"	1920x1080	16:9	0.24795mm	102.4 dpi	250 nits	1000:1	7 ms	72%	178 / 178	Adjustable Stand	15.57W / 35W	90W 88% Adapter	3-year	04/16

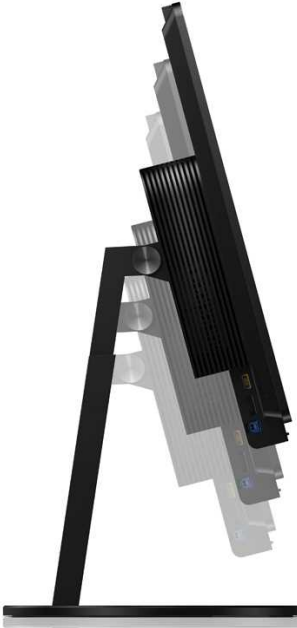

ThinkCentre Tiny-in-One (TIO) 23

Product Specifications Reference (PSREF)

Model	10DQPAR6US			Mounting features	Wall or desk mounting using the extend arm or third-party accessories meeting the VESA FPMPMI® (100mm mount)																
Form factor	Tiny-in-One, offers a full All-In-One experience when optional Tiny slots into the back of TIO 23, clean cabling and effortless setup			Adjustable stand	<i>Tilt:</i> 35° back, -5° forward; <i>lift:</i> 4.3" (110mm); <i>swivel:</i> +/-45°																
Compatible Tiny:	M93/p Tiny, M83 Tiny, M73 Tiny, or M53 Tiny * Processor, memory, storage, operating system, WLAN, Bluetooth, Keyboard, mouse, etc., depend on the Tiny installed (optional)			Power supply	90 watts AC/DC adapter, 88% PSU, universal																
Panel	TFT-LCD, twisted nematic (TN), White LED backlight			Power consumption	22 watts typical, 45 watts maximum, <0.5 watts standby / suspend																
Viewable image size	23.0" (584.2mm) diagonal			Limited warranty ³	3-years , Customer Carry-In Exchange (CCE) via Rapid Replacement, IWS (International Warranty Service ³) / service upgrades available <i>For Lenovo service upgrade options, please go to S-TC sheet</i>																
Max view area (W x H)	20.05" x 11.28" / 509.2mm x 286.4mm			VESA-compliant ²	VESA DDC2B/CI, VESA DPMS-compliant																
Optimum resolution	1920x1080			Ergonomics	ISO 9241-307																
Aspect ratio	16:9			Emission standards	FCC Class B																
Pixel pitch (mm)	.265mm			Environmental	TCO (TCO Certified Edge 1.1), WEEE, RoHS, ENERGY STAR® 6.0																
Dot/Pixel per Inch	96 dpi			Windows certifications	EPEAT™ Gold rating, ULE, TUV Windows 7, Windows 8, and Windows 8.1 certified																
Brightness	250 nits or cd/m ² (typical)			Ship group	TIO 23 (Monitor), detachable stand, Information flyer, Reference and driver CD, AC/DC power adapter, power cord, quickly-released screw																
Contrast ratio	1000:1 (typical)			Accessories	For compatible accessories, please go to TC-AQP sheet																
Pixel response time	5ms (typical)			<table border="1" style="width: 100%; border-collapse: collapse;"> <thead> <tr> <th colspan="4">ThinkCentre Tiny-in-One 23 Compatible list</th> </tr> <tr> <th>Model</th> <th>M900 Tiny, M700 Tiny, M600 Tiny, M83 Tiny, M53 Tiny</th> <th>M93/p Tiny, M73 Tiny</th> <th>Chromebox</th> </tr> </thead> <tbody> <tr> <td>Turn on TIO and Tiny together via Alt + P on USB KB</td> <td>All models</td> <td>All models</td> <td>Not support</td> </tr> <tr> <td>Turn on TIO and Tiny together via TIO Power Button</td> <td>All models</td> <td>TIO models</td> <td>All models</td> </tr> </tbody> </table>		ThinkCentre Tiny-in-One 23 Compatible list				Model	M900 Tiny, M700 Tiny, M600 Tiny, M83 Tiny, M53 Tiny	M93/p Tiny, M73 Tiny	Chromebox	Turn on TIO and Tiny together via Alt + P on USB KB	All models	All models	Not support	Turn on TIO and Tiny together via TIO Power Button	All models	TIO models	All models
ThinkCentre Tiny-in-One 23 Compatible list																					
Model	M900 Tiny, M700 Tiny, M600 Tiny, M83 Tiny, M53 Tiny	M93/p Tiny, M73 Tiny	Chromebox																		
Turn on TIO and Tiny together via Alt + P on USB KB	All models	All models	Not support																		
Turn on TIO and Tiny together via TIO Power Button	All models	TIO models	All models																		
Color gamut	72%																				
Anti-reflective	Anti-glare																				
Horizontal frequency	30 to 83kHz																				
Vertical frequency	50 to 75Hz																				
Viewing angle at 10:1 CR	170° (+/- 85°) horizontal, 160° (+/- 80°) vertical																				
Preset resolutions	640x350 @ 70Hz 640x480 @ 60Hz, 66Hz, 72Hz, 75Hz 720x400 @ 70Hz 800x600 @ 60Hz, 72Hz, 75Hz 1024x768 @ 60Hz, 70Hz, 75Hz 1152x864 @ 75Hz 1280x800 @ 60Hz 1280x1024 @ 60Hz, 72Hz, 75Hz 1366x768 @ 60Hz 1440x900 @ 60Hz, 75Hz 1600x1200 @ 60Hz, 70Hz, 75Hz 1680x1050 @ 60Hz 1920x1080 @ 60Hz																				
Presets / user settings	Presets: 25; user settings: 25																				
On screen display	On screen display with digital user controls (8 languages)																				
Control features	Mode-switching (TIO mode / standalone monitor mode, switches video/audio/USB input source) / Back button, Left shift button, Right shift / Brightness button, Selection button / Menu button, Power button																				
Tiny-in-One Power On	Pressing Alt + P on keyboard or pressing Power button positioned on TIO can turn on both TIO and Tiny (only some Tiny support, see compatible list)																				
USB ports	<i>Front:</i> two USB 3.0 (only when M93/p or M83 installed) or two USB 2.0 <i>Side:</i> two USB 2.0, one USB 2.0 upstream port (connect to PC), one mini USB 2.0 port for accessories (on top) * The USB ports are only available when a Tiny is installed or a PC is connected via USB upstream port																				
Monitor connectors	One DisplayPort port, version 1.2																				
3-in-1 Cable	Undetachable 3-in-1 cable (Power connector, USB, DisplayPort), only for connecting to Tiny installed (optional)																				
Audio port	one headphone / microphone combo jack (stereo, 3.5mm)																				
Security	Security keyhole for attachment of optional cable lock (Kensington® lock compatible), locks optional Tiny and ODD box with TIO 23 together, more security features offered by Tiny installed (optional)																				
Mechanical	<table border="1" style="width: 100%; border-collapse: collapse;"> <thead> <tr> <th>Dimensions</th> <th>TIO 23 without stand</th> <th>TIO 23 with stand</th> </tr> </thead> <tbody> <tr> <td>W x D x H (inch)</td> <td>22.17 x 2.74 x 14.88</td> <td>22.17 x 9.84 x 16.15 - 20.48</td> </tr> <tr> <td>W x D x H (mm)</td> <td>563 x 69.5 x 378</td> <td>563 x 250 x 410.14 - 520.14</td> </tr> <tr> <th>Weight (approximately)</th> <th>TIO 23 with stand</th> <th>TIO 23 with Tiny, stand, and ODD box installed</th> </tr> <tr> <td>lb / kg</td> <td>15.4lb / 7kg</td> <td>18.9lb / 8.58kg</td> </tr> </tbody> </table>			Dimensions	TIO 23 without stand	TIO 23 with stand	W x D x H (inch)	22.17 x 2.74 x 14.88	22.17 x 9.84 x 16.15 - 20.48	W x D x H (mm)	563 x 69.5 x 378	563 x 250 x 410.14 - 520.14	Weight (approximately)	TIO 23 with stand	TIO 23 with Tiny, stand, and ODD box installed	lb / kg	15.4lb / 7kg	18.9lb / 8.58kg			
Dimensions	TIO 23 without stand	TIO 23 with stand																			
W x D x H (inch)	22.17 x 2.74 x 14.88	22.17 x 9.84 x 16.15 - 20.48																			
W x D x H (mm)	563 x 69.5 x 378	563 x 250 x 410.14 - 520.14																			
Weight (approximately)	TIO 23 with stand	TIO 23 with Tiny, stand, and ODD box installed																			
lb / kg	15.4lb / 7kg	18.9lb / 8.58kg																			

See footnotes for more detailed information

Model	Region	Color	Display Size	Resolution	Aspect Ratio	Pixel Pitch	Dot / Pixel Per Inch	Brightness	Contrast Ratio	Pixel Response Time	Color Gamut	View Angle (H / V)	Stand	Power Consumption (Typical / Maximum)	Power Supply	Warranty	Ann Date (mm/yy)
10DQPAR6US	US	Black	23"	1920x1080	16:9	0.265mm	96 dpi	250 nits	1000:1	5 ms	72%	170 / 160	Adjustable Stand	22W / 45W	90W 88% Adapter	3-year	10/14



ThinkCentre Tiny-in-One (TIO) 24

Product Specifications Reference (PSREF)

Model	10LLPAR6++ / 10LLPAT6++														
Form factor	Tiny-in-One, offers a full All-In-One experience when optional Tiny slots into the back of TIO 24, clean cabling and effortless setup														
Compatible Tiny:	M900 Tiny, M700 Tiny, M600 Tiny, M93/p Tiny*, M83 Tiny, M73 Tiny*, or M53 Tiny, Chromebox * Non-TIO models can't be turned on by pressing power button of TIO 24														
Panel	TFT-LCD, In-Plane Switching (IPS), White LED backlight														
Viewable image size	23.8" (604.7mm) diagonal														
Max view area (W x H)	21.06" x 12.32" / 535.0mm x 313.0mm														
Bezel Width	Top / Side: 2mm, Bottom: 16.3mm														
Optimum resolution	1920x1080														
Aspect ratio	16:9														
Pixel pitch (mm)	0.2745mm														
Dot/Pixel per Inch	92.6 dpi														
Brightness	250 nits or cd/m ² (typical)														
Contrast ratio	1000:1 (typical)														
Pixel response time	7ms														
Color gamut	72%														
Anti-reflective	Anti-glare														
Viewing angle at 10:1 CR	178° (+/- 89°) horizontal, 178° (+/- 89°) vertical														
Preset resolutions	640x350 @ 70Hz 640x480 @ 60Hz, 66Hz, 72Hz, 75Hz 720x400 @ 70Hz 800x600 @ 60Hz, 72Hz, 75Hz 1024x768 @ 60Hz, 70Hz, 75Hz 1152x864 @ 75Hz 1280x800 @ 60Hz 1280x1024 @ 60Hz, 72Hz, 75Hz 1366x768 @ 60Hz 1440x900 @ 60Hz, 75Hz 1600x1200 @ 60Hz, 70Hz, 75Hz 1680x1050 @ 60Hz 1920x1080 @ 60Hz														
Presets / user settings	Presets: 25; user settings: 25														
On screen display	On screen display with digital user controls (8 languages)														
Control features	Mode-switching (TIO mode / standalone monitor mode, switches video / audio / USB input sources) / Back button, Left shift button, Right shift / Brightness button, Selection button / Menu button, Power button														
Tiny-in-One Power On	Pressing Alt + P on keyboard or pressing Power button positioned on TIO can turn on both TIO and Tiny (only some Tiny support, see compatible list)														
Front ports	Two USB 3.0 or two USB 2.0 (when M73 or M53 installed or USB 2.0 connected via USB upstream port), one headphone / microphone combo jack (3.5mm) * The USB ports are only available when a Tiny is installed or a PC is connected via USB upstream port														
Side ports	Side ports offered by installed Tiny (optional)														
Rear ports	One DisplayPort 1.2 port, one USB upstream port, one power connector														
3-in-1 Cable	Undetachable 3-in-1 cable (Power connector, USB 3.0 [supports USB 3.0/USB 2.0], DisplayPort 1.2), only for connecting to Tiny installed (optional)														
Internal Speaker	1.5 watt x1														
Security	Security keyhole for attachment of optional cable lock (Kensington® lock compatible), locks optional Tiny with TIO 24 together, more security features offered by Tiny installed (optional)														
Mechanical	<table border="1"> <thead> <tr> <th>Dimensions</th> <th>TIO 24 without stand</th> <th>TIO 24 with stand</th> </tr> </thead> <tbody> <tr> <td>W x D x H (inch)</td> <td>21.24 x 2.7 x 13.64</td> <td>21.24 x 9.90 x 15.16 - 19.46</td> </tr> <tr> <td>W x D x H (mm)</td> <td>539.6 x 68.2 x 346.45</td> <td>539.6 x 251.4 x 385.08 - 495.08</td> </tr> <tr> <td>Weight (approximately)</td> <td colspan="2">12.25 lb /5.57 kg (with stand)</td> </tr> </tbody> </table>			Dimensions	TIO 24 without stand	TIO 24 with stand	W x D x H (inch)	21.24 x 2.7 x 13.64	21.24 x 9.90 x 15.16 - 19.46	W x D x H (mm)	539.6 x 68.2 x 346.45	539.6 x 251.4 x 385.08 - 495.08	Weight (approximately)	12.25 lb /5.57 kg (with stand)	
Dimensions	TIO 24 without stand	TIO 24 with stand													
W x D x H (inch)	21.24 x 2.7 x 13.64	21.24 x 9.90 x 15.16 - 19.46													
W x D x H (mm)	539.6 x 68.2 x 346.45	539.6 x 251.4 x 385.08 - 495.08													
Weight (approximately)	12.25 lb /5.57 kg (with stand)														
Mounting features	Wall or desk mounting using the extend arm or third-party accessories meeting the VESA FPMPMI® (100mm mount)														
Adjustable stand	Tilt: 35° back, -5° forward; lift: 4.3" (110mm); swivel: +/-45°														
Power supply	90 watts AC/DC adapter, 88% PSU, universal														
Power consumption	16.7 watts typical, 35 watts maximum, <0.5 watts standby / suspend														
Limited warranty ³	3-years , Customer Carry-In or Mail-In via Rapid Replacement Service														
VESA-compliant ²	VESA DDC2B/CI, VESA DPMS-compliant														
Ergonomics	ISO 9241-307														
Emission standards	FCC Class B														
Environmental	TCO 7.0, TCO Edge 2.0, WEEE, RoHS, ENERGY STAR® 7.0														
Windows certifications	EPEAT™ Gold rating, ULE Gold, TUV, VOC Windows 7, Windows 8/8.1, and Windows 10 certified														
Ship group	TIO 24 (Monitor), detachable stand, AC/DC power adapter, power cord, user's guide and driver CD, quick start and safety poster														
Accessories	For compatible accessories, please go to http://www.lenovoquickpick.com														
ThinkCentre Tiny-in-One 24 Compatible list															
Model	M900 Tiny, M700 Tiny, M600 Tiny, M83 Tiny, M53 Tiny	M93/p Tiny, M73 Tiny	Chromebox												
Turn on TIO and Tiny together via Alt + P on USB KB	All models	All models	Not support												
Turn on TIO and Tiny together via TIO Power Button	All models	TIO models	All models												

See footnotes for more detailed information

ThinkCentre Tiny-In-One 24 - 10LL

Product Specifications Reference (PSREF)

Model	Region	Color	Display Size	Resolution	Aspect Ratio	Pixel Pitch	Dot / Pixel Per Inch	Brightness	Contrast Ratio	Pixel Response Time	Color Gamut	View Angle (H / V)	Stand	Power Consumption (Typical / Maximum)	Power Supply	Warranty	Ann Date (mm/yy)
10LLPAR6US	US	Black	23.8"	1920x1080	16:9	0.2745mm	92.6 dpi	250 nits	1000:1	7 ms	72%	178 / 178	Adjustable Stand	16.7W / 35W	90W 88% Adapter	3-year	05/16
10LLPAT6US	US	Black	23.8"	1920x1080	16:9	0.2745mm	92.6 dpi	250 nits	1000:1	7 ms	72%	178 / 178	Adjustable Stand	16.7W / 35W	90W 88% Adapter	3-year	05/16



ThinkCentre X1 Platform Specifications

Product Specifications Reference (PSREF)

Processor	Intel® 6th Generation Intel Core™ i3 / i5 / i7 Processor	Security features	<ul style="list-style-type: none"> Security slot (in rear for attachment of optional Kensington® MicroSaver® cable; Kensington lock also locks chassis) Smart USB protection, allows keyboard/mouse only, blocks all storage devices Power-on, admin, hard disk password Boot sequence control Boot without keyboard and mouse Individual USB port disablement Optional chassis intrusion switch 																																			
	<table border="1"> <thead> <tr> <th>Processor</th> <th>Cores / Threads</th> <th>Frequency Base/Max(GHz)</th> <th>Cache</th> <th>Memory Types</th> <th>Integrated Graphics</th> <th>Intel vPro</th> </tr> </thead> <tbody> <tr> <td>Core i3-6100U</td> <td>2 / 4</td> <td>2.3 G</td> <td>3 MB</td> <td>DDR4-2133</td> <td>HD 520</td> <td>No</td> </tr> <tr> <td>Core i5-6200U</td> <td>2 / 4</td> <td>2.3 G / 2.8 G</td> <td>3 MB</td> <td>DDR4-2133</td> <td>HD 520</td> <td>No</td> </tr> <tr> <td>Core i5-6300U</td> <td>2 / 4</td> <td>2.4 G / 3.0 G</td> <td>3 MB</td> <td>DDR4-2133</td> <td>HD 520</td> <td>vPro</td> </tr> <tr> <td>Core i7-6600U</td> <td>2 / 4</td> <td>2.6 G / 3.4 G</td> <td>4 MB</td> <td>DDR4-2133</td> <td>HD 520</td> <td>vPro</td> </tr> </tbody> </table> <p>Intel Architecture (IA) SoC that integrates Intel processor core, graphics, memory controller, and I/O interfaces into a single system-on-chip solution</p>	Processor	Cores / Threads	Frequency Base/Max(GHz)	Cache	Memory Types	Integrated Graphics	Intel vPro	Core i3-6100U	2 / 4	2.3 G	3 MB	DDR4-2133	HD 520	No	Core i5-6200U	2 / 4	2.3 G / 2.8 G	3 MB	DDR4-2133	HD 520	No	Core i5-6300U	2 / 4	2.4 G / 3.0 G	3 MB	DDR4-2133	HD 520	vPro	Core i7-6600U	2 / 4	2.6 G / 3.4 G	4 MB	DDR4-2133	HD 520	vPro	Keyboard	Some: Lenovo Slim USB Keyboard (USB connector), black Some: Ultralim Plus Wireless Keyboard (2.4GHz via USB receiver), black
Processor	Cores / Threads	Frequency Base/Max(GHz)	Cache	Memory Types	Integrated Graphics	Intel vPro																																
Core i3-6100U	2 / 4	2.3 G	3 MB	DDR4-2133	HD 520	No																																
Core i5-6200U	2 / 4	2.3 G / 2.8 G	3 MB	DDR4-2133	HD 520	No																																
Core i5-6300U	2 / 4	2.4 G / 3.0 G	3 MB	DDR4-2133	HD 520	vPro																																
Core i7-6600U	2 / 4	2.6 G / 3.4 G	4 MB	DDR4-2133	HD 520	vPro																																
Memory	16GB max, DDR4 2133, one 260-pin SO-DIMM socket	Mouse	Some: Enhanced Optical USB Mouse, black, Lenovo logo Some: Ultralim Plus Wireless Mouse (2.4GHz via USB receiver), black																																			
Disk	Some: SATA 6.0Gb/s, 2.5" Wide, 5400 rpm or 7200 rpm Some: Solid State Hybrid Drive (SSHD) / with 8GB MLC NAND flash memory, SATA 6.0Gb/s, 2.5" Wide, 5400 rpm Some: Solid State Drive (SSD) / SATA 6.0Gb/s, 2.5" Wide	Mechanical	<ul style="list-style-type: none"> Business black color, Aluminum Alloy Toolless back cover and memory removal Optional VESA mount kit (100mm) <table border="1"> <thead> <tr> <th></th> <th>Dimensions (WxDxH)</th> <th>Max weight (lb / kg)</th> <th>Adjustments</th> </tr> </thead> <tbody> <tr> <td>Without stand:</td> <td>22.4 X 1.3 X 14.2 (inch); 570 X 33 X 360 (mm)</td> <td>8.8 / 4</td> <td>N/A</td> </tr> <tr> <td>With Orchid tilt stand:</td> <td>22.4 X 9.4 X 17.8 (inch); 570 X 240 X 451 (mm)</td> <td>11.0 / 5</td> <td>Tilt: 45° back, -5° forward</td> </tr> </tbody> </table>		Dimensions (WxDxH)	Max weight (lb / kg)	Adjustments	Without stand:	22.4 X 1.3 X 14.2 (inch); 570 X 33 X 360 (mm)	8.8 / 4	N/A	With Orchid tilt stand:	22.4 X 9.4 X 17.8 (inch); 570 X 240 X 451 (mm)	11.0 / 5	Tilt: 45° back, -5° forward																							
	Dimensions (WxDxH)	Max weight (lb / kg)	Adjustments																																			
Without stand:	22.4 X 1.3 X 14.2 (inch); 570 X 33 X 360 (mm)	8.8 / 4	N/A																																			
With Orchid tilt stand:	22.4 X 9.4 X 17.8 (inch); 570 X 240 X 451 (mm)	11.0 / 5	Tilt: 45° back, -5° forward																																			
Optical Media reader	None Optional 9-in-1 media card reader	Power supply	90 watts adapter, autosensing, 88% PSU																																			
Graphics	Intel HD Graphics 520 in processor, uses main memory, DirectX® 12, external monitor support via DisplayPort™; Max resolution: 4096x2304 (DP)@60Hz	Limited warranty ³	Some: 1-year or 3-year, limited onsite service Some: 3-years, limited onsite service, OID (Onsite International Delivery) / For <i>Lenovo service upgrade options, please go to S-TC sheet</i>																																			
DP Dongle Display	Optional DP to VGA, DP to DVI-D (single link), or DP to HDMI 1.4 dongle 23.8" (604.5mm) Full HD 1080p (1920x1080) TFT color , IPS panel, wide viewing angle (+/- 89°), LED backlight, 250 nits, 16:9 aspect ratio, 1000:1 contrast ratio, anti-glare, work as standalone monitor via DisplayPort (DP in / out combo)	Preload	Preloaded operating system Some: Windows® 7 Professional 32/64 preinstalled through downgrade rights in Windows 10 Pro 64-bit Some: Windows 7 Professional 64 Some: Windows 10 Pro 64-bit Some: Windows 10 Home 64-bit Preloaded applications (only some listed) <ul style="list-style-type: none"> Desktop Power Manager Lenovo Solution Center Lenovo REACHit Lenovo SHAREit Lenovo Bluetooth Lock (for models with Wi-Fi/BT card) McAfee® LiveSafe™ (30-day trial) Microsoft Office preloaded; purchase a product key to activate Lenovo ThinkVantage Tools <ul style="list-style-type: none"> Only for Window 10 Lenovo Companion Only for Window 7 Rescue and Recovery Password Manager ThinkVantage System Update Lenovo Message Center Plus Adobe® Reader® 																																			
Light sensor	None	Environment	EPEAT™ Gold rating; ENERGY STAR® 6.1; TCO Certified Edge; TUV Green Mark; ULE Gold; ErP Lot 3; GREENGUARD® certified; RoHS-compliant																																			
Multi-touch	None	MIL-SPEC test	MIL-STD-810G military certification (Low Pressure [Altitude], High Temperature, Low Temperature, Temperature Shock, Humidity, Sand and Dust, Vibration, Shock)																																			
Camera	2.0-megapixel camera, fixed focus, supports 1080p, with dual array digital microphone, LED indicator, physical switch on/off, Skype for Business certified	Accessories	For compatible accessories, please go to TC-AQP sheet																																			
Controls	Microphone mute, DP in / out switch, and power button																																					
Chipset	Intel System-on-Chip (SoC) platform																																					
Rear ports	Three USB 3.0, ethernet (RJ-45), DisplayPort in/out combo port,																																					
Side ports	Two USB 3.0 (one is Always On and fast charge), optional card reader, one headphone / microphone combo jack (3.5mm)																																					
M.2 card slot	One M.2 Card slot (for WLAN)																																					
Audio support	High Definition (HD) Audio, Realtek ALC233 / two internal speakers (5W x 2), Dolby® Audio™ certified, Skype for Business certified																																					
WLAN ¹³	Some: 11ac wireless, M.2 Card, Qualcomm Atheros QCA6174 (dual band), Wi-Fi + Bluetooth 4.1 combo adapter, 2x2 Some: 11ac wireless, M.2 Card, Intel Dual Band Wireless-AC 8260, Wi-Fi + Bluetooth 4.1 combo adapter, 2x2 Some: 11ac wireless, M.2 Card, Intel Dual Band Wireless-AC 8260, Wi-Fi + Bluetooth 4.1 combo adapter, Intel vPro technology support, 2x2																																					
Bluetooth™ Ethernet	Some: Bluetooth 4.0 or 4.1 wireless, integrated in Wi-Fi + Bluetooth combo adapter Gigabit ethernet, Intel Ethernet Connection I219-LM (Jacksonville), Wake on LAN®																																					
Manageability	Intel Active Management Technology 11.0 (Intel AMT 11.0) on some models; Intel vPro technology on some models (require choosing a vPro-support Wi-Fi adapter to enable vPro function through wireless connection)																																					
Security chip	Trusted Platform Module (TPM 1.2-compliant)																																					

See footnotes for more detailed information

© Lenovo
(X1-Spec) July 2016

ThinkCentre X1 AIO - TopSeller - 10KE

Product Specifications Reference (PSREF)

Model	Region	Processor	vPro	Graphics	Monitor Cable	Memory	Display	Multi-touch	Storage(HDD/SSD)	Media Reader	WLAN + Bluetooth	Camera	Chassis Intrusion Switch	Keyboard / Mouse	Stand	Power Supply	Operating System	Warranty	Global	Ann Date (mm/yy)
10KE0007US	US	i5-6200U	No	Intel HD 520	None	8GBx1	23.8" FHD (1920x1080) IPS Anti-glare	None	256GB SSD	9-in-1	8260 ac, 2x2 + BT4.1	1080p	None	2.4G / 2.4G	Orchid Tilt Stand	90W 88% Adapter	Win10 DG Win7 Pro 64	3-year, Onsite	No	01/16
10KE0008US	US	i5-6200U	No	Intel HD 520	None	4GBx1	23.8" FHD (1920x1080) IPS Anti-glare	None	120GB SSD	9-in-1	8260 ac, 2x2 + BT4.1	1080p	None	2.4G / 2.4G	Orchid Tilt Stand	90W 88% Adapter	Win10 DG Win7 Pro 64	3-year, Onsite	No	01/16
10KE001CUS	US	i5-6200U	No	Intel HD 520	None	8GBx1	23.8" FHD (1920x1080) IPS Anti-glare	None	256GB SSD	None	8260 ac, 2x2 + BT4.1	1080p	None	USB (Slim) / USB	Orchid Tilt Stand	90W 88% Adapter	Win10 Pro 64	3-year, Onsite	No	08/16
10KE001DUS	US	i5-6200U	No	Intel HD 520	None	4GBx1	23.8" FHD (1920x1080) IPS Anti-glare	None	128GB SSD	None	8260 ac, 2x2 + BT4.1	1080p	None	USB (Slim) / USB	Orchid Tilt Stand	90W 88% Adapter	Win10 Pro 64	3-year, Onsite	No	08/16
10KE001EUS	US	i5-6200U	No	Intel HD 520	None	4GBx1	23.8" FHD (1920x1080) IPS Anti-glare	None	128GB SSD	None	8260 ac, 2x2 + BT4.1	1080p	None	2.4G / 2.4G	Orchid Tilt Stand	90W 88% Adapter	Win10 Pro 64	3-year, Onsite	No	09/16
10KE001FUS	US	i5-6200U	No	Intel HD 520	None	8GBx1	23.8" FHD (1920x1080) IPS Anti-glare	None	256GB SSD	None	8260 ac, 2x2 + BT4.1	1080p	None	2.4G / 2.4G	Orchid Tilt Stand	90W 88% Adapter	Win10 Pro 64	3-year, Onsite	No	09/16
10KE001GUS	US	i5-6200U	No	Intel HD 520	None	4GBx1	23.8" FHD (1920x1080) IPS Anti-glare	None	500GB 7200rpm 2.5"	None	8260 ac, 2x2 + BT4.1	1080p	None	2.4G / 2.4G	Orchid Tilt Stand	90W 88% Adapter	Win10 Pro 64	3-year, Onsite	No	09/16
10KE001HUS	US	i5-6200U	No	Intel HD 520	None	4GBx1	23.8" FHD (1920x1080) IPS Anti-glare	None	500GB 7200rpm 2.5"	None	8260 ac, 2x2 + BT4.1	1080p	None	2.4G / 2.4G	Orchid Tilt Stand	90W 88% Adapter	Win10 DG Win7 Pro 64	3-year, Onsite	No	09/16
10KE001JUS	US	i5-6200U	No	Intel HD 520	None	4GBx1	23.8" FHD (1920x1080) IPS Anti-glare	None	128GB SSD	None	8260 ac, 2x2 + BT4.1	1080p	None	2.4G / 2.4G	Orchid Tilt Stand	90W 88% Adapter	Win10 DG Win7 Pro 64	3-year, Onsite	No	09/16
10KE001LUS	US	i5-6200U	No	Intel HD 520	None	8GBx1	23.8" FHD (1920x1080) IPS Anti-glare	None	256GB SSD Opal	9-in-1	8260 ac, 2x2 + BT4.1	1080p	None	2.4G / 2.4G	Orchid Tilt Stand	90W 88% Adapter	Win10 DG Win7 Pro 64	3-year, Onsite	No	12/16
10KE001MUS	US	i5-6200U	No	Intel HD 520	None	8GBx1	23.8" FHD (1920x1080) IPS Anti-glare	None	256GB SSD Opal	None	8260 ac, 2x2 + BT4.1	1080p	None	2.4G / 2.4G	Orchid Tilt Stand	90W 88% Adapter	Win10 Pro 64	3-year, Onsite	No	12/16
10KE001NUS	US	i5-6200U	No	Intel HD 520	None	8GBx1	23.8" FHD (1920x1080) IPS Anti-glare	None	256GB SSD Opal	None	8260 ac, 2x2 + BT4.1	1080p	None	USB (Slim) / USB	Orchid Tilt Stand	90W 88% Adapter	Win10 Pro 64	3-year, Onsite	No	12/16

- Availability:** All offers subject to availability. Lenovo reserves the right to alter product offerings and specifications at any time, without notice. Lenovo is not responsible for photographic or typographic errors.
- Warranty:** For a copy of applicable product warranties, go to http://support.lenovo.com/en_US/product-service/warranty-status/WarrantyPolicies.page. Lenovo makes no representation or warranty regarding third party products or services.
- ¹ **Limited warranty:** Support unrelated to a warranty issue may be subject to additional charges.
 - ² **Hard drive:** GB = billion bytes, TB = trillion bytes. Accessible capacity is less; up to 4GB is service partition.
 - ³ **Limited onsite service systems** are designed to be repaired during the applicable warranty period primarily with customer-replaceable parts provided by Lenovo. Lenovo will only send a technician onsite to perform a repair if (a) remote telephone diagnosis and/or customer part replacement are unable to resolve the problem, or (b) the part is one of the few designated by Lenovo for onsite replacement. For a list of onsite replaceable parts, contact Lenovo. Support unrelated to a warranty issue may be subject to additional charges. Lenovo onsite repair (LOR), 8 am to 5 pm, Monday through Friday coverage excluding holidays, next business day (NBD) response time.
 - ⁴ **CD and DVD list** maximum rates; rates are variable and are often less than the maximum.
 - ⁵ **Included software** may differ from its retail version (if available), and may not include user manuals or all program functionality. License agreements may apply.
 - ⁷ **Lenovo Services:** These services are available for machines normally used for business, professional, or trade purposes, rather than personal, family, or household purposes. Not all machine types and models are covered. Service period begins with the equipment date of purchase. Service must be purchased during the original limited product warranty period. Service levels are response time objectives and are not guarantees. If the machine problem turns out to be a Customer Replaceable Unit (CRU), a part will be express shipped to you for quick replacement. Onsite 24x7x2-hour service is not available in all locations. P&L means parts and labor. P/U means pick-up. See lenovo terms and conditions for complete details and restrictions.
 - ⁸ **Memory:** For PCs without a separate graphics card, memory supports both system and video. Accessible system memory may be up to 384MB less than the amount stated, depending on video mode.
 - ⁹ **International Warranty Service** is available in any country in which this product is sold and serviced. Service delivery methods and parts availability vary by country, may be different from that in the country of purchase, and are subject to change without notice. Fees and restrictions may apply in some countries.
 - ¹⁰ **Modem speeds:** Public network download speeds are limited to 53Kbps. Upload speeds are limited to 48Kbps for V.92 modems. Actual speeds depend on many factors and are often less than the maximum possible. V.92 functions and speeds require compatible phone line and server equipment. Check with your telephone and ISP service providers for availability.
 - ¹¹ **For combination drives**, maximum speeds only are given in the following order: CD read, CD write, CD re-write, DVD read.
 - ¹² **The IEEE 802.11n specification (MIMO)** has been finalized and is currently in IEEE 802.11n-2009 release. The maximum speed depends on the access point device and the number of integrated antenna used for connection. An adapter with 11a/b, 11a/b/g, 11b/g/n, or 11a/b/g/n can communicate on any of its supported formats.
 - ¹³ **Wireless capability:** Requires compatible wireless-enabled options sold separately.
 - ¹⁴ **Response times may vary.** May exclude some holidays. Telephone support may be subject to additional charges.
 - ¹⁵ **Update Connector** is available at no charge to registered customers during the limited warranty period. Line charges may apply.
 - ¹⁶ **Embedded Security Subsystem** works with optional VPN software.

- ¹⁸ **Embedded Security Subsystem** may require download of client security software from the Web.
- ¹⁹ **Asset ID** allows system-specific information to be stored in a chip inside the system; it does not have any radio frequency support.
- ²⁰ **Operating System:** Level of support varies by operating system. Operating systems not preloaded on the system may not provide full feature functionality. Refer to lenovo.com/pc/support and enter your machine type and model number for more information.

This publication was developed for products and services offered in the United States. Lenovo may not offer the products, services or features discussed in this document in other countries. Lenovo may withdraw an offering at any time. Information is subject to change without notice. Consult your local representative for information on offerings available in your area.

Lenovo reserves the right to change specifications and other product information at any time without prior notice. Lenovo is not responsible for photographic or typographical errors. LENOVO PROVIDES THIS PUBLICATION "AS IS" WITHOUT WARRANTY OF ANY KIND, EITHER EXPRESS OR IMPLIED, INCLUDING THE IMPLIED WARRANTIES OF MERCHANTABILITY OR FITNESS FOR A PARTICULAR PURPOSE. Some jurisdictions do not allow disclaimer of express or implied warranties in certain transactions; therefore this disclaimer may not apply to you.

ThinkCentre®

Trademarks: Lenovo, the Lenovo logo, New World. New Thinking., Access Connections, Rescue and Recovery, ThinkCentre, ThinkPad, ThinkVantage, and ThinkVision are trademarks of Lenovo. Microsoft, Windows, and Vista are registered trademarks of Microsoft Corporation. Intel, the Intel logo, Intel Inside logo, Intel Core and Core Inside are trademarks of Intel Corporation in the US and other countries. Other company, product, or service names may be trademarks or service marks of others.

Visit www.lenovo.com/safecomputing periodically for the latest information on safe and effective computing.

Visit www.lenovo.com/psref for the latest version of Product Specifications Reference.

© Lenovo, 2017.
All rights reserved.

Lenovo
1009 Think Place
Morrisville, NC 27560
U.S.A.

tcbook.pdf

Lenovo™ **ThinkStation.**

PSREF



Product Specifications Reference

Version 501, January 2017

U.S.

Visit <http://psref.lenovo.com> for the latest version

Contents

Cover	1	Legal Information	32
Contents	2		
Summary Of Change	3		
P Series	5		
ThinkStation P310 SFF	5		
ThinkStation P310 SFF Platform Specifications	6		
ThinkStation P310 SFF - TopSeller - 30AV - 1 of 2	7		
ThinkStation P310 SFF - TopSeller - 30AV - 2 of 2	8		
ThinkStation P310 Tower	9		
ThinkStation P310 Tower Platform Specifications	10		
ThinkStation P310 Tower - TopSeller - 30AT - 1 of 3	11		
ThinkStation P310 Tower - TopSeller - 30AT - 2 of 3	12		
ThinkStation P310 Tower - TopSeller - 30AT - 3 of 3	13		
ThinkStation P410	14		
ThinkStation P410 Platform Specifications	14		
ThinkStation P410 - TopSeller - 30B3 - 1 of 3	15		
ThinkStation P410 - TopSeller - 30B3 - 2 of 3	16		
ThinkStation P410 - TopSeller - 30B3 - 3 of 3	17		
ThinkStation P510	18		
ThinkStation P510 Platform Specifications	18		
ThinkStation P510 - TopSeller - 30B5 - 1 of 4	19		
ThinkStation P510 - TopSeller - 30B5 - 2 of 4	20		
ThinkStation P510 - TopSeller - 30B5 - 3 of 4	21		
ThinkStation P510 - TopSeller - 30B5 - 4 of 4	22		
ThinkStation P700	23		
ThinkStation P700 Platform Specifications	24		
ThinkStation P700 - TopSeller - 30A9	25		
ThinkStation P700 - 30A8	26		
ThinkStation P710	27		
ThinkStation P710 Platform Specifications	27		
ThinkStation P710 - TopSeller - 30B7 - 1 of 2	28		
ThinkStation P710 - TopSeller - 30B7 - 2 of 2	29		
ThinkStation P910	30		
ThinkStation P910 Platform Specifications	30		
ThinkStation P910 - TopSeller - 30B9	31		

Summary of Changes

This section describes the changes made in this version of ThinkStation PSREF and in previous version. This edition might also include minor corrections and editorial changes which are not identified.

January 25, 2017 - Version 500

- ▶ Update quantity of PCIe SSD adapter in ThinkStation P510/P910

January 4, 2017 - Version 500

- ▶ Added ThinkStation P310 models announced on December 2016

December 14, 2016 - Version 499

- ▶ Added ThinkStation P410/P510/P710/P910 EMEA models
- ▶ Added 1TB M.2 PCIe SSD, Quadro P5000, Quadro P6000 support on ThinkStation P510/P710/P910
- ▶ Added Quadro P5000 support on ThinkStation P410
- ▶ Added 6TB 7.2K SATA6Gbs HDD support on ThinkStation P410/P510/P710/P910
- ▶ Added ThinkStation P410/P510/P710/P910 models announced on December 2016

November 23, 2016 - Version 498

- ▶ Removed ThinkStation P500/P900 due to EOL
- ▶ Added ThinkStation P310 Tower and SFF models announced on November 2016

October 12, 2016 - Version 496

- ▶ Removed flash option on ThinkStation P510/P710/P910
- ▶ Added ThinkStation P310/P410/P510/P710/P910 models announced on September 2016

August 3, 2016 - Version 493

- ▶ Removed ThinkStation P500/P700/P900 Windows 7 DG from Win8.1 U.S. models
- ▶ Added keyboard and mouse features on all ThinkStation

July 13, 2016 - Version 492

- ▶ Added ThinkStation P500, P700, and P900 Windows 10 downgrade to Windows 7 models
- ▶ Updated Maximum configuration weight of ThinkStation P410
- ▶ Added ThinkStation P710 and P910 models announced on on July 2016
- ▶ Added "Maximum drives in 3.5" bay" feature on ThinkStation P500/P510/P700/P710/P900/P910

June 22, 2016 - Version 491

- ▶ Added new product ThinkStation P410/P510
- ▶ Added NVIDIA Quadro M2000 on ThinkStation P310 Tower
- ▶ Added keyboard and mouse information on ThinkStation P710/P910
- ▶ Added internal USB information on ThinkStation P710/P910

June 2, 2016 - Version 490

- ▶ Added ThinkStation P710/P910 US models
- ▶ Updated ThinkStation P710/P910 processor information

May 19, 2016 - Version 489

- ▶ Added NVIDIA Quadro M2000 on compatible product
- ▶ Updated maximum weight on ThinkStation P710
- ▶ Removed 30AT000BUS

April 27, 2016 - Version 488

- ▶ Added ThinkStation P710 and P910 models for EMEA, announced on April 2016
- ▶ Updated Energy star information on ThinkStation P500/P700/P710/P900/P910

April 6, 2016 - Version 487

- ▶ New ThinkStation P710 and P910, announced April 5, 2016 (specification only)

March 23, 2016 - Version 486

- ▶ Added processors specifications for P310/P500/P700/P900

February 24, 2016 - Version 485

- ▶ Added ThinkStation P310 and P700 models for US, announced on February 2016
- ▶ Added ThinkStation P700 and P900 models for EMEA, announced on February 2016

December 9, 2015 - Version 482

- ▶ New ThinkStation P310 Tower and SFF, announced November 24, 2015

November 18, 2015 - Version 481

- ▶ Combines ThinkStation PSREF United States version and Western Europe version.
- ▶ Extends the supported GEO into Europe, Middle East and Africa.
- ▶ Covers all TopSeller and Relationship models for US and all focus models for EMEA



ThinkStation P310 SFF Platform Specifications

Product Specifications Reference (PSREF)

Components	Specification																																			
Chipset	Intel C236 Chipset																																			
Intel AMT	Intel Active Management Technology 11 supported on Xeon models																																			
Processor	One LGA1151 socket, supports one the following processors:																																			
	Xeon E3-1280 v5	4C/3.7GHz/8MB/80W/DDR4-2133																																		
	Xeon E3-1275 v5	4C/3.6GHz/8MB/80W/DDR4-2133																																		
	Xeon E3-1270 v5	4C/3.6GHz/8MB/80W/DDR4-2133																																		
	Xeon E3-1245 v5	4C/3.5GHz/8MB/80W/DDR4-2133																																		
	Xeon E3-1240 v5	4C/3.5GHz/8MB/80W/DDR4-2133																																		
	Xeon E3-1230 v5	4C/3.4GHz/8MB/80W/DDR4-2133																																		
	Xeon E3-1225 v5	4C/3.3GHz/8MB/80W/DDR4-2133																																		
	Xeon E3-1220 v5	4C/3GHz/8MB/80W/DDR4-2133																																		
	Core i7-6700	4C/3.4GHz/8MB/65W/DDR4-2133																																		
	Core i5-6600	4C/3.3GHz/6MB/65W/DDR4-2133																																		
	Core i5-6500	4C/3.2GHz/6MB/65W/DDR4-2133																																		
	Core i5-6400	4C/2.7GHz/6MB/65W/DDR4-2133																																		
	Core i3-6320	2C/3.9GHz/4MB/51W/DDR4-2133																																		
Core i3-6300	2C/3.8GHz/4MB/51W/DDR4-2133																																			
Core i3-6100	2C/3.7GHz/3MB/51W/DDR4-2133																																			
Memory DIMM slots	4 DIMM slots, 2-channel (integrated memory controller in processor)																																			
Memory type/capacity	Up to 64GB ECC/non-ECC (4 x 16GB), DDR4-2133, UDIMM																																			
Intel HD Graphics in processor	Integrated Intel HD P530 in Xeon E3-12x5 v5 processors; or Intel HD 530 in Core i7, i5, or i3 processors. Works along with discrete graphics to support multi-display, enables three display connectors (2 DP, 1 VGA) on rear. Max Resolution: 4096 x 2304																																			
Discrete graphics	Two PCI Express 3.0 x16 slots for graphics adapters. Up to two Quadro K1200. Supports the following NVIDIA graphics adapters:																																			
	<table border="1"> <thead> <tr> <th>Adapter</th> <th>Cores</th> <th>Memory</th> <th>Power</th> <th>Connector</th> </tr> </thead> <tbody> <tr> <td>NVS 310</td> <td>48</td> <td>1GB</td> <td>19.5W</td> <td>2xDP</td> </tr> <tr> <td>NVS 315</td> <td>48</td> <td>1GB</td> <td>19.5W</td> <td>2xDVI-I SL/2xDP</td> </tr> <tr> <td>NVS 510</td> <td>192</td> <td>2GB</td> <td>33.4W</td> <td>4xmini DP</td> </tr> <tr> <td>Quadro K420</td> <td>192</td> <td>2GB</td> <td>41W</td> <td>1xDVI-I DL+1xDP</td> </tr> <tr> <td>Quadro K620</td> <td>384</td> <td>2GB</td> <td>45W</td> <td>1xDVI-I DL+1xDP</td> </tr> <tr> <td>Quadro K1200</td> <td>512</td> <td>4GB</td> <td>45W</td> <td>4xminiDP</td> </tr> </tbody> </table>	Adapter	Cores	Memory	Power	Connector	NVS 310	48	1GB	19.5W	2xDP	NVS 315	48	1GB	19.5W	2xDVI-I SL/2xDP	NVS 510	192	2GB	33.4W	4xmini DP	Quadro K420	192	2GB	41W	1xDVI-I DL+1xDP	Quadro K620	384	2GB	45W	1xDVI-I DL+1xDP	Quadro K1200	512	4GB	45W	4xminiDP
	Adapter	Cores	Memory	Power	Connector																															
	NVS 310	48	1GB	19.5W	2xDP																															
	NVS 315	48	1GB	19.5W	2xDVI-I SL/2xDP																															
	NVS 510	192	2GB	33.4W	4xmini DP																															
	Quadro K420	192	2GB	41W	1xDVI-I DL+1xDP																															
Quadro K620	384	2GB	45W	1xDVI-I DL+1xDP																																
Quadro K1200	512	4GB	45W	4xminiDP																																
Onboard drive controller	Five onboard SATA 6.0Gb/s connectors for optical and disk drives plus one SATA connector for optional eSATA. RAID 0, 1, 5* support * RAID 5 supports three 2.5" SSD drives only.																																			
Drive Bays	One external 5.25" bay, one internal 3.5" bay (see right). Up to one 9.5mm optical + 2 x 3.5" disk drive bays + 1 x 2.5" disk drive bay + one M.2 NVMe SSD																																			
Supporting disk drives	<table border="1"> <tbody> <tr> <td>3.5" SATA HDD (7.2K 6Gbs)</td> <td>500GB/1TB/2TB/3TB/4TB/6TB/1TB hybrid/2TB hybrid</td> </tr> <tr> <td>2.5" SATA SSD (6Gbs)</td> <td>128GB/180GB*/240GB*/256GB*/480GB*/512GB*/1TB*</td> </tr> <tr> <td>M.2 NVMe SSD</td> <td>256GB*/512GB*/1TB*, via PCIe 3.0 x4 adapter</td> </tr> </tbody> </table>	3.5" SATA HDD (7.2K 6Gbs)	500GB/1TB/2TB/3TB/4TB/6TB/1TB hybrid/2TB hybrid	2.5" SATA SSD (6Gbs)	128GB/180GB*/240GB*/256GB*/480GB*/512GB*/1TB*	M.2 NVMe SSD	256GB*/512GB*/1TB*, via PCIe 3.0 x4 adapter																													
	3.5" SATA HDD (7.2K 6Gbs)	500GB/1TB/2TB/3TB/4TB/6TB/1TB hybrid/2TB hybrid																																		
	2.5" SATA SSD (6Gbs)	128GB/180GB*/240GB*/256GB*/480GB*/512GB*/1TB*																																		
M.2 NVMe SSD	256GB*/512GB*/1TB*, via PCIe 3.0 x4 adapter																																			
	** Includes OPAL options																																			
Max internal storage	9TB (2 x 4TB 3.5" HDDs + 1 x 1TB 2.5" SSD) plus one 512GB M.2 NVMe SSD																																			
Media reader	9-in-1 card reader. Optional 29-in-1 card reader on selected models																																			
Power supply	210 watts with variable speed fan, autosensing, 85% PSU, Climate Savers Computing Bronze, 80 PLUS Bronze qualified																																			
Onboard Ethernet	One onboard gigabit ethernet, Intel I219LM, supports Wake-on-LAN																																			
HD Audio	Realtek ALC662 codec																																			
TPM	Standard, TCG 1.2-compliant																																			
Front ports	Two USB 3.0, microphone (3.5mm), headphone (3.5mm)																																			
Rear ports	1 VGA and 2 DisplayPort (functional only on Intel HD Graphics models), two USB 2.0, four USB 3.0 (blue), one serial (9-pin), one ethernet (RJ-45), three analog audio ports (line-in, line-out, mic-in)																																			
Additional ports	Supports the following optional ports: • Two IEEE 1394 (one on rear and one on front flex module) via PCIe adapter, up to one adapter per system. Supports one of the following per system: • Two rear USB 3.0 per PCIe adapter. • One front eSATA (on flex module), or one rear eSATA via cable and PCIe slot bracket, up to one eSATA port per system. • One additional serial port via cable. • One parallel port via cable																																			

Components	Specification
Mechanical	<ul style="list-style-type: none"> Raven black color; metal case 4.02"W x 15.53"D x 13.31"H 102mm W x 394.5mm D x 338mm H 17.2 lb (7.9kg) max configuration 12.9-liter
	Environmental certifications
Limited warranty	1 or 3-year limited onsite service with 9x5/NBD. Some parts are Customer Replaceable Units.

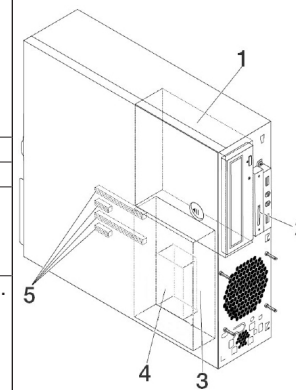

Drive Bays and PCIe Slots

Bay 1	5.25", supports one of the following: HH optical/flex module***/9.5mm optical+3.5" HDD bay/ 3.5" HDD bay/Front Access Storage Enclosure *** Flex module supports one or more of the following: 9.5mm optical/ 29-in-1 reader/front IEEE 1394/front eSATA. Up to one flex module is supported per system.
Bay 2	Optional 9-in-1 single slot reader
Bay 3	Standard 3.5" HDD bay
Bay 4	Optional 2.5" HDD bay (under Bay 3)
5 - Slots	Four PCIe slots (top-down): Slot 1: Low Profile, PCIe 3.0 x16 (near CPU) Slot 2: Low Profile, PCIe 3.0 x1 Slot 3: Low Profile, PCIe 3.0 x16 (x4 elec) Slot 4: Low Profile, PCIe 3.0 x1

For the list of ISV certifications, please visit www.thinkworkstations.com/isv-certifications/
For a list of all supported options, please visit https://download.lenovo.com/pccbbs/options_iso/ocm_december_2016.xlsx sheet

Model	Region	Processor	Graphics	Memory (Capacity/Type)	Storage (Capacity/Type/Interface)	Optical	Media Reader	Power Supply	Add-on Ports	Discrete Ethernet	Chassis Intrusion Switch	Keyboard / Mouse	Operating System	Warranty	Global	Ann Date (mm/yy)
30AV0007US	US	Core i5-6500 4C/3.2GHz/6MB/65W/DDR4-2133	Intel HD 530	1x4GB UDIMM DDR4-2133 Non-ECC	1x1TB HDD 7.2K 3.5" SATA6Gbs	HH DVD±RW	9-in-1	210W 85%	None	None	Switch	USB / USB Optical	Win10 DG Win7 Pro 64	3-year	No	11/15
30AV0008US	US	Core i3-6100 2C/3.7GHz/3MB/51W/DDR4-2133	Intel HD 530	1x4GB UDIMM DDR4-2133 Non-ECC	1x1TB HDD 7.2K 3.5" SATA6Gbs	HH DVD±RW	9-in-1	210W 85%	None	None	Switch	USB / USB Optical	Win10 DG Win7 Pro 64	3-year	No	11/15
30AV0009US	US	Core i3-6100 2C/3.7GHz/3MB/51W/DDR4-2133	Intel HD 530	1x4GB UDIMM DDR4-2133 Non-ECC	1x500GB HDD 7.2K 3.5" SATA6Gbs	HH DVD±RW	9-in-1	210W 85%	None	None	Switch	USB / USB Optical	Win10 DG Win7 Pro 64	3-year	No	11/15
30AV000AUS	US	Core i5-6600 4C/3.3GHz/6MB/65W/DDR4-2133	Intel HD 530	1x8GB UDIMM DDR4-2133 Non-ECC	1x1TB HDD 7.2K 3.5" SATA6Gbs	HH DVD±RW	9-in-1	210W 85%	None	None	Switch	USB / USB Optical	Win10 DG Win7 Pro 64	3-year	No	11/15
30AV000BUS	US	Core i7-6700 4C/3.4GHz/8MB/65W/DDR4-2133	Intel HD 530	1x8GB UDIMM DDR4-2133 Non-ECC	1x1TB HDD 7.2K 3.5" SATA6Gbs	HH DVD±RW	9-in-1	210W 85%	None	None	Switch	USB / USB Optical	Win10 DG Win7 Pro 64	3-year	No	11/15
30AV000CUS	US	Core i7-6700 4C/3.4GHz/8MB/65W/DDR4-2133	Intel HD 530	1x8GB UDIMM DDR4-2133 Non-ECC	1x256GB SSD 2.5" SATA6Gbs Opal	HH DVD±RW	9-in-1	210W 85%	None	None	Switch	USB / USB Optical	Win10 DG Win7 Pro 64	3-year	No	11/15
30AV000DUS	US	Xeon E3-1245 v5 4C/3.5GHz/8MB/80W/DDR4-2133	Intel HD P530	1x8GB UDIMM DDR4-2133 Non-ECC	1x256GB SSD 2.5" SATA6Gbs Opal	HH DVD±RW	9-in-1	210W 85%	None	None	Switch	USB / USB Optical	Win10 DG Win7 Pro 64	3-year	No	11/15
30AV000EUS	US	Xeon E3-1240 v5 4C/3.5GHz/8MB/80W/DDR4-2133	NVIDIA Quadro K620 2GB	1x8GB UDIMM DDR4-2133 Non-ECC	1x256GB SSD 2.5" SATA6Gbs Opal	HH DVD±RW	9-in-1	210W 85%	None	None	Switch	USB / USB Optical	Win10 DG Win7 Pro 64	3-year	No	11/15
30AV000VUS	US	Core i5-6500 4C/3.2GHz/6MB/65W/DDR4-2133	Intel HD 530+NVIDIA Quadro K620 2GB	1x8GB UDIMM DDR4-2133 Non-ECC	1x1TB HDD 7.2K 3.5" SATA6Gbs	HH DVD±RW	9-in-1	210W 85%	None	None	Switch	USB / USB Optical	Win10 DG Win7 Pro 64	3-year	No	02/16
30AV000WUS	US	Core i7-6700 4C/3.4GHz/8MB/65W/DDR4-2133	Intel HD 530+NVIDIA Quadro K620 2GB	2x8GB UDIMM DDR4-2133 Non-ECC	1x256GB SSD 2.5" SATA6Gbs Opal	HH DVD±RW	9-in-1	210W 85%	None	None	Switch	USB / USB Optical	Win10 DG Win7 Pro 64	3-year	No	02/16
30AV000XUS	US	Xeon E3-1230 v5 4C/3.4GHz/8MB/80W/DDR4-2133	NVIDIA Quadro K1200 4GB	4x8GB UDIMM DDR4-2133 Non-ECC	1x512GB SSD 2.5" SATA6Gbs	HH DVD±RW	9-in-1	210W 85%	None	None	Switch	USB / USB Optical	Win10 DG Win7 Pro 64	3-year	No	02/16
30AV0012US	US	Core i7-6700 4C/3.4GHz/8MB/65W/DDR4-2133	Intel HD 530+NVIDIA Quadro K620 2GB	1x8GB UDIMM DDR4-2133 Non-ECC	1x1TB HDD 7.2K 3.5" SATA6Gbs	HH DVD±RW	9-in-1	210W 85%	None	None	Switch	USB / USB Optical	Win10 Pro 64	3-year	No	07/16
30AV001TUS	US	Core i7-6700 4C/3.4GHz/8MB/65W/DDR4-2133	Intel HD 530	1x8GB UDIMM DDR4-2133 Non-ECC	1x1TB HDD 7.2K 3.5" SATA6Gbs	HH DVD±RW	9-in-1	210W 85%	None	None	Switch	USB / USB Optical	Win10 Pro 64	3-year	No	07/16
30AV001UUS	US	Core i5-6500 4C/3.2GHz/6MB/65W/DDR4-2133	Intel HD 530	1x8GB UDIMM DDR4-2133 Non-ECC	1x1TB HDD 7.2K 3.5" SATA6Gbs	HH DVD±RW	9-in-1	210W 85%	None	None	Switch	USB / USB Optical	Win10 Pro 64	3-year	No	07/16
30AV001VUS	US	Xeon E3-1240 v5 4C/3.5GHz/8MB/80W/DDR4-2133	NVIDIA Quadro K1200 4GB	1x8GB UDIMM DDR4-2133 ECC	1x256GB SSD 2.5" SATA6Gbs Opal	HH DVD±RW	9-in-1	210W 85%	None	None	Switch	USB / USB Optical	Win10 Pro 64	3-year	No	07/16

Model	Region	Processor	Graphics	Memory (Capacity/Type)	Storage (Capacity/Type/Interface)	Optical	Media Reader	Power Supply	Add-on Ports	Discrete Ethernet	Chassis Intrusion Switch	Keyboard / Mouse	Operating System	Warranty	Global	Ann Date (mm/yy)
30AV001WUS	US	Xeon E3-1240 v5 4C/3.5GHz/8MB/80W/DDR4-2133	NVIDIA Quadro K620 2GB	1x8GB UDIMM DDR4-2133 ECC	1x1TB HDD 7.2K 3.5" SATA6Gbs	HH DVD±RW	9-in-1	210W 85%	None	None	Switch	USB / USB Optical	Win10 Pro 64	3-year	No	07/16
30AV001XUS	US	Xeon E3-1245 v5 4C/3.5GHz/8MB/80W/DDR4-2133	Intel HD P530	1x8GB UDIMM DDR4-2133 ECC	1x1TB HDD 7.2K 3.5" SATA6Gbs	HH DVD±RW	9-in-1	210W 85%	None	None	Switch	USB / USB Optical	Win10 Pro 64	3-year	No	07/16
30AV001YUS	US	Core i3-6100 2C/3.7GHz/3MB/51W/DDR4-2133	Intel HD 530	1x8GB UDIMM DDR4-2133 Non- ECC	1x1TB HDD 7.2K 3.5" SATA6Gbs	HH DVD±RW	9-in-1	210W 85%	None	None	Switch	USB / USB Optical	Win10 Pro 64	3-year	No	07/16
30AV0020US	US	Xeon E3-1245 v5 4C/3.5GHz/8MB/80W/DDR4-2133	Intel HD P530	1x8GB UDIMM DDR4-2133 ECC	1x256GB SSD 2.5" SATA6Gbs Opal	HH DVD±RW	9-in-1	210W 85%	None	None	Switch	USB / USB Optical	Win10 Pro 64	3-year	No	07/16
30AV0021US	US	Xeon E3-1220 v5 4C/3GHz/8MB/80W/DDR4-2133	NVIDIA Quadro K620 2GB	1x8GB UDIMM DDR4-2133 ECC	1x1TB HDD 7.2K 3.5" SATA6Gbs	HH DVD±RW	9-in-1	210W 85%	None	None	Switch	USB / USB Optical	Win10 Pro 64	3-year	No	07/16
30AV0022US	US	Xeon E3-1240 v5 4C/3.5GHz/8MB/80W/DDR4-2133	NVIDIA Quadro K1200 4GB	1x8GB UDIMM DDR4-2133 ECC	1x1TB HDD 7.2K 3.5" SATA6Gbs	HH DVD±RW	9-in-1	210W 85%	None	None	Switch	USB / USB Optical	Win10 Pro 64	3-year	No	07/16
30AV0023US	US	Xeon E3-1240 v5 4C/3.5GHz/8MB/80W/DDR4-2133	NVIDIA Quadro K620 2GB	1x8GB UDIMM DDR4-2133 ECC	1x256GB SSD 2.5" SATA6Gbs Opal	HH DVD±RW	9-in-1	210W 85%	None	None	Switch	USB / USB Optical	Win10 Pro 64	3-year	No	07/16
30AV002DUS	US	Core i7-6700 4C/3.4GHz/8MB/65W/DDR4-2133	Intel HD 530+NVIDIA Quadro K620 2GB	2x8GB UDIMM DDR4-2133 Non- ECC	1x1TB HDD 7.2K 3.5" SATA6Gbs	HH DVD±RW	9-in-1	210W 85%	None	None	Switch	USB / USB Optical	Win10 DG Win7 Pro 64	3-year	No	12/16
30AV002EUS	US	Core i5-6500 4C/3.2GHz/6MB/65W/DDR4-2133	Intel HD 530+NVIDIA Quadro K620 2GB	1x8GB UDIMM DDR4-2133 Non- ECC	1x256GB SSD 2.5" SATA6Gbs Opal	HH DVD±RW	9-in-1	210W 85%	None	None	Switch	USB / USB Optical	Win10 DG Win7 Pro 64	3-year	No	12/16



ThinkStation P310 Tower Platform Specifications

Product Specifications Reference (PSREF)

Components	Specification																																																		
Chipset	Intel C236 Chipset																																																		
Intel AMT	Intel Active Management Technology 11 supported on Xeon models																																																		
Processor	One LGA1151 socket, supports one the following processors:																																																		
	Xeon E3-1280 v5	4C/3.7GHz/8MB/80W/DDR4-2133																																																	
	Xeon E3-1275 v5	4C/3.6GHz/8MB/80W/DDR4-2133																																																	
	Xeon E3-1270 v5	4C/3.6GHz/8MB/80W/DDR4-2133																																																	
	Xeon E3-1245 v5	4C/3.5GHz/8MB/80W/DDR4-2133																																																	
	Xeon E3-1240 v5	4C/3.5GHz/8MB/80W/DDR4-2133																																																	
	Xeon E3-1230 v5	4C/3.4GHz/8MB/80W/DDR4-2133																																																	
	Xeon E3-1225 v5	4C/3.3GHz/8MB/80W/DDR4-2133																																																	
	Xeon E3-1220 v5	4C/3GHz/8MB/80W/DDR4-2133																																																	
	Core i7-6700	4C/3.4GHz/8MB/65W/DDR4-2133																																																	
	Core i5-6600	4C/3.3GHz/6MB/65W/DDR4-2133																																																	
	Core i5-6500	4C/3.2GHz/6MB/65W/DDR4-2133																																																	
	Core i5-6400	4C/2.7GHz/6MB/65W/DDR4-2133																																																	
	Core i3-6320	2C/3.9GHz/4MB/51W/DDR4-2133																																																	
Core i3-6300	2C/3.8GHz/4MB/51W/DDR4-2133																																																		
Core i3-6100	2C/3.7GHz/3MB/51W/DDR4-2133																																																		
Memory DIMM slots	4 DIMM slots, 2-channel (integrated memory controller in processor)																																																		
Memory type/capacity	Up to 64GB ECC/non-ECC (4 x 16GB), DDR4-2133, UDIMM																																																		
Intel HD Graphics in processor	Integrated Intel HD P530 in Xeon E3-12x5 v5 processors; or Intel HD 530 in Core i7, i5, or i3 processors. Works along with discrete graphics to support multi-display, enables three display connectors (2 DP, 1 VGA) on rear. Max resolution: 4096 x 2304																																																		
Discrete graphics	Two PCI Express 3.0 x16 slots for graphics adapters. Up to two Quadro K1200 on 250 watts models. Or up to two Quadro K2200, or up to one Quadro M4000 on 400 watts models. Supports the following NVIDIA graphics adapters:																																																		
	<table border="1"> <thead> <tr> <th>Adapter</th> <th>Cores</th> <th>Memory</th> <th>Power</th> <th>Connector</th> </tr> </thead> <tbody> <tr> <td>NVS 310</td> <td>48</td> <td>1GB</td> <td>19.5W</td> <td>2xDP</td> </tr> <tr> <td>NVS 315</td> <td>48</td> <td>1GB</td> <td>19.5W</td> <td>2xDVI-I SL/2xDP</td> </tr> <tr> <td>NVS 510</td> <td>192</td> <td>2GB</td> <td>33.4W</td> <td>4xmini DP</td> </tr> <tr> <td>Quadro K420</td> <td>192</td> <td>2GB</td> <td>41W</td> <td>1xDVI-I DL+1xDP</td> </tr> <tr> <td>Quadro K620</td> <td>384</td> <td>2GB</td> <td>45W</td> <td>1xDVI-I DL+1xDP</td> </tr> <tr> <td>Quadro K1200</td> <td>512</td> <td>4GB</td> <td>45W</td> <td>4xminiDP</td> </tr> <tr> <td>Quadro K2200</td> <td>640</td> <td>4GB</td> <td>68W</td> <td>1xDVI-I DL+2xDP</td> </tr> <tr> <td>Quadro M2000</td> <td>768</td> <td>4GB</td> <td>75W</td> <td>4xDP</td> </tr> <tr> <td>Quadro M4000</td> <td>1664</td> <td>8GB</td> <td>120W</td> <td>4xDP</td> </tr> </tbody> </table>	Adapter	Cores	Memory	Power	Connector	NVS 310	48	1GB	19.5W	2xDP	NVS 315	48	1GB	19.5W	2xDVI-I SL/2xDP	NVS 510	192	2GB	33.4W	4xmini DP	Quadro K420	192	2GB	41W	1xDVI-I DL+1xDP	Quadro K620	384	2GB	45W	1xDVI-I DL+1xDP	Quadro K1200	512	4GB	45W	4xminiDP	Quadro K2200	640	4GB	68W	1xDVI-I DL+2xDP	Quadro M2000	768	4GB	75W	4xDP	Quadro M4000	1664	8GB	120W	4xDP
	Adapter	Cores	Memory	Power	Connector																																														
	NVS 310	48	1GB	19.5W	2xDP																																														
	NVS 315	48	1GB	19.5W	2xDVI-I SL/2xDP																																														
	NVS 510	192	2GB	33.4W	4xmini DP																																														
	Quadro K420	192	2GB	41W	1xDVI-I DL+1xDP																																														
	Quadro K620	384	2GB	45W	1xDVI-I DL+1xDP																																														
	Quadro K1200	512	4GB	45W	4xminiDP																																														
	Quadro K2200	640	4GB	68W	1xDVI-I DL+2xDP																																														
Quadro M2000	768	4GB	75W	4xDP																																															
Quadro M4000	1664	8GB	120W	4xDP																																															
Onboard drive controller	Five onboard SATA 6.0Gb/s connectors for optical and disk drives plus one SATA connector for optional eSATA. RAID 0, 1, 5, 10 support																																																		
Drive Bays	Two external 5.25" bays, two internal 3.5" bays (see right). Up to one 9.5mm optical plus 4 x 3.5" disk drive bays plus one M.2 NVMe SSD																																																		
Supporting disk drives	3.5" SATA HDD (7.2K 6Gbs)	500GB/1TB/2TB/3TB/4TB/6TB/1TB hybrid/2TB hybrid																																																	
	2.5" SATA SSD (6Gbs)	128GB/180GB*/240GB*/256GB*/480GB*/512GB*/1TB*																																																	
	M.2 NVMe SSD	256GB*/512GB*/1TB*, via PCIe 3.0 x4 adapter																																																	
	** Includes OPAL options																																																		
Max internal storage	16TB (4 x 4TB 3.5" HDDs) plus 512GB M.2 NVMe SSD																																																		
Media reader	9-in-1 card reader. Optional 29-in-1 card reader on selected models																																																		
Power supply	Supports one of the following: <ul style="list-style-type: none"> 250 watts with variable speed fan, autosensing, 85% PSU, Climate Savers Computing Bronze, 80 PLUS Bronze qualified 400 watts with variable speed fan, autosensing, 92% PSU, Climate Savers Computing Platinum, 80 PLUS Platinum qualified 																																																		
Onboard Ethernet	One onboard gigabit ethernet, Intel I219LM, supports Wake-on-LAN																																																		
HD Audio	Realtek ALC662 codec																																																		
TPM	Standard, TCG 1.2-compliant																																																		
Front ports	Two USB 3.0, microphone (3.5mm), headphone (3.5mm)																																																		
Rear ports	1 VGA and 2 DisplayPort (for Intel HD Graphics models only), two USB 2.0, four USB 3.0 (blue), one serial (9-pin), one ethernet (RJ-45), three analog audio ports (line-in, line-out, mic-in)																																																		

Components	Specification
Additional ports	Supports the following optional ports: <ul style="list-style-type: none"> Two IEEE 1394 (one on rear and one on front flex module) via PCIe adapter, up to one adapter per system. Supports one of the following per system: <ul style="list-style-type: none"> Two rear USB 3.0 per PCIe adapter. One rear Thunderbolt via PCIe adapter. One front eSATA (on flex module), or one rear eSATA via cable and PCIe slot bracket, up to one eSATA port per system. One additional serial port via cable. One parallel port via cable
	Mechanical
Environmental certifications	GREENGUARD certified/RoHS-compliant/EPEAT Gold rating/ENERGY STAR 6.1 qualified
Limited warranty	3-year limited onsite service with 9x5/NBD. Some parts are Customer Replaceable Units.

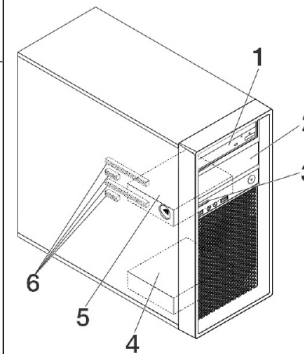

Drive Bays and PCIe Slots

Bay 1 and Bay 2	5.25", support one of the following: HH optical/flex module**/9.5mm optical+3.5" HDD bay/ 3.5" HDD bay/Front Access Storage Enclosure ** Flex module supports one or more of the following: 9.5mm optical/ 29-in-1 reader/front IEEE 1394/front eSATA Up to one flex module is supported per system.
Bay 3	Optional 9-in-1 single slot reader
Bay 4	Standard 3.5" HDD bay
Bay 5	Standard 3.5" HDD bay
6 -Slots	Four PCIe slots (top-down): Slot 1: Half length, full height, PCIe 3.0 x16 (near CPU) Slot 2: Half length, full height, PCIe 3.0 x1 Slot 3: Half length, full height, PCIe 3.0 x16 (x4 elec) Slot 4: Half length, full height, PCIe 3.0 x1

For the list of ISV certifications, please visit www.thinkworkstations.com/isv-certifications/
For a list of all supported options, please visit https://download.lenovo.com/pccbbs/options_iso/ocm_december_2016.xlsx sheet

Model	Region	Processor	Graphics	Memory (Capacity/Type)	Storage (Capacity/Type/Interface)	Optical	Media Reader	Power Supply	Add-on Ports	Discrete Ethernet	Chassis Intrusion Switch	Keyboard / Mouse	Operating System	Warranty	Global	Ann Date (mm/yy)
30AT000BUS	US	Core i7-6700 4C/3.4GHz/8MB/65W/DDR4-2133	Intel HD 530	1x8GB UDIMM DDR4-2133 ECC	1x1TB HDD 7.2K 3.5" SATA6Gbs	HH DVD±RW	9-in-1	250W 85%	None	None	Switch	USB / USB Optical	Win10 DG Win7 Pro 64	3-year	No	11/15
30AT000CUS	US	Xeon E3-1245 v5 4C/3.5GHz/8MB/80W/DDR4-2133	Intel HD P530	1x8GB UDIMM DDR4-2133 ECC	1x1TB HDD 7.2K 3.5" SATA6Gbs	HH DVD±RW	9-in-1	250W 85%	None	None	Switch	USB / USB Optical	Win10 DG Win7 Pro 64	3-year	No	11/15
30AT000EUS	US	Core i7-6700 4C/3.4GHz/8MB/65W/DDR4-2133	Intel HD 530	1x8GB UDIMM DDR4-2133 Non- ECC	1x1TB HDD 7.2K 3.5" SATA6Gbs	HH DVD±RW	9-in-1	250W 85%	None	None	Switch	USB / USB Optical	Win10 DG Win7 Pro 64	3-year	No	11/15
30AT000FUS	US	Xeon E3-1245 v5 4C/3.5GHz/8MB/80W/DDR4-2133	Intel HD P530	1x8GB UDIMM DDR4-2133 Non- ECC	1x1TB HDD 7.2K 3.5" SATA6Gbs	HH DVD±RW	9-in-1	250W 85%	None	None	Switch	USB / USB Optical	Win10 DG Win7 Pro 64	3-year	No	11/15
30AT000GUS	US	Xeon E3-1245 v5 4C/3.5GHz/8MB/80W/DDR4-2133	Intel HD P530	1x8GB UDIMM DDR4-2133 Non- ECC	1x256GB SSD 2.5" SATA6Gbs Opal	HH DVD±RW	9-in-1	250W 85%	None	None	Switch	USB / USB Optical	Win10 DG Win7 Pro 64	3-year	No	11/15
30AT000HUS	US	Xeon E3-1240 v5 4C/3.5GHz/8MB/80W/DDR4-2133	NVIDIA Quadro K620 2GB	1x8GB UDIMM DDR4-2133 Non- ECC	1x1TB HDD 7.2K 3.5" SATA6Gbs	HH DVD±RW	9-in-1	250W 85%	None	None	Switch	USB / USB Optical	Win10 DG Win7 Pro 64	3-year	No	11/15
30AT000JUS	US	Core i7-6700 4C/3.4GHz/8MB/65W/DDR4-2133	Intel HD 530+NVIDIA Quadro K620 2GB	1x8GB UDIMM DDR4-2133 Non- ECC	1x1TB HDD 7.2K 3.5" SATA6Gbs	HH DVD±RW	9-in-1	250W 85%	None	None	Switch	USB / USB Optical	Win10 DG Win7 Pro 64	3-year	No	11/15
30AT000KUS	US	Core i7-6700 4C/3.4GHz/8MB/65W/DDR4-2133	Intel HD 530+NVIDIA Quadro K2200 4GB	1x8GB UDIMM DDR4-2133 Non- ECC	1x1TB HDD 7.2K 3.5" SATA6Gbs	HH DVD±RW	9-in-1	250W 85%	None	None	Switch	USB / USB Optical	Win10 DG Win7 Pro 64	3-year	No	11/15
30AT000LUS	US	Core i7-6700 4C/3.4GHz/8MB/65W/DDR4-2133	Intel HD 530+NVIDIA Quadro K2200 4GB	2x8GB UDIMM DDR4-2133 Non- ECC	1x256GB SSD 2.5" SATA6Gbs Opal	HH DVD±RW	9-in-1	250W 85%	None	None	Switch	USB / USB Optical	Win10 DG Win7 Pro 64	3-year	No	11/15
30AT000MUS	US	Core i7-6700 4C/3.4GHz/8MB/65W/DDR4-2133	Intel HD 530	2x8GB UDIMM DDR4-2133 Non- ECC	1x256GB SSD 2.5" SATA6Gbs Opal	HH DVD±RW	9-in-1	250W 85%	None	None	Switch	USB / USB Optical	Win10 DG Win7 Pro 64	3-year	No	11/15
30AT000NUS	US	Core i5-6500 4C/3.2GHz/6MB/65W/DDR4-2133	Intel HD 530	1x8GB UDIMM DDR4-2133 Non- ECC	1x1TB HDD 7.2K 3.5" SATA6Gbs	HH DVD±RW	9-in-1	250W 85%	None	None	Switch	USB / USB Optical	Win10 DG Win7 Pro 64	3-year	No	11/15
30AT000PUS	US	Xeon E3-1245 v5 4C/3.5GHz/8MB/80W/DDR4-2133	Intel HD P530	2x8GB UDIMM DDR4-2133 Non- ECC	1x256GB SSD M.2 PCIe Opal	HH DVD±RW	9-in-1	400W 92%	None	None	Switch	USB / USB Optical	Win10 DG Win7 Pro 64	3-year	No	11/15
30AT005CUS	US	Xeon E3-1240 v5 4C/3.5GHz/8MB/80W/DDR4-2133	NVIDIA Quadro K620 2GB	1x8GB UDIMM DDR4-2133 ECC	1x256GB SSD M.2 PCIe Opal	HH DVD±RW	9-in-1	250W 85%	None	None	Switch	USB / USB Optical	Win10 Pro 64	3-year	No	07/16
30AT005DUS	US	Xeon E3-1220 v5 4C/3GHz/8MB/80W/DDR4-2133	NVIDIA Quadro K620 2GB	1x8GB UDIMM DDR4-2133 ECC	1x1TB HDD 7.2K 3.5" SATA6Gbs	HH DVD±RW	9-in-1	250W 85%	None	None	Switch	USB / USB Optical	Win10 Pro 64	3-year	No	07/16
30AT005EUS	US	Xeon E3-1240 v5 4C/3.5GHz/8MB/80W/DDR4-2133	NVIDIA Quadro M2000 4GB	1x8GB UDIMM DDR4-2133 ECC	1x256GB SSD M.2 PCIe Opal	HH DVD±RW	9-in-1	250W 85%	None	None	Switch	USB / USB Optical	Win10 Pro 64	3-year	No	07/16

Model	Region	Processor	Graphics	Memory (Capacity/Type)	Storage (Capacity/Type/Interface)	Optical	Media Reader	Power Supply	Add-on Ports	Discrete Ethernet	Chassis Intrusion Switch	Keyboard / Mouse	Operating System	Warranty	Global	Ann Date (mm/yy)
30AT005FUS	US	Xeon E3-1245 v5 4C/3.5GHz/8MB/80W/DDR4-2133	Intel HD P530	1x8GB UDIMM DDR4-2133 ECC	1x256GB SSD M.2 PCIe Opal	HH DVD±RW	9-in-1	250W 85%	None	None	Switch	USB / USB Optical	Win10 Pro 64	3-year	No	07/16
30AT005GUS	US	Core i7-6700 4C/3.4GHz/8MB/65W/DDR4-2133	Intel HD 530+NVIDIA Quadro K620 2GB	1x8GB UDIMM DDR4-2133 Non- ECC	1x1TB HDD 7.2K 3.5" SATA6Gbs	HH DVD±RW	9-in-1	250W 85%	None	None	Switch	USB / USB Optical	Win10 Pro 64	3-year	No	07/16
30AT005HUS	US	Core i7-6700 4C/3.4GHz/8MB/65W/DDR4-2133	Intel HD 530	1x8GB UDIMM DDR4-2133 Non- ECC	1x1TB HDD 7.2K 3.5" SATA6Gbs	HH DVD±RW	9-in-1	400W 92%	None	None	Switch	USB / USB Optical	Win10 Pro 64	3-year	No	07/16
30AT005JUS	US	Xeon E3-1245 v5 4C/3.5GHz/8MB/80W/DDR4-2133	Intel HD P530	1x8GB UDIMM DDR4-2133 ECC	1x1TB HDD 7.2K 3.5" SATA6Gbs	HH DVD±RW	9-in-1	400W 92%	None	None	Switch	USB / USB Optical	Win10 Pro 64	3-year	No	07/16
30AT005KUS	US	Core i5-6500 4C/3.2GHz/6MB/65W/DDR4-2133	Intel HD 530+NVIDIA Quadro K620 2GB	1x8GB UDIMM DDR4-2133 Non- ECC	1x1TB HDD 7.2K 3.5" SATA6Gbs	HH DVD±RW	9-in-1	250W 85%	None	None	Switch	USB / USB Optical	Win10 Pro 64	3-year	No	07/16
30AT005LUS	US	Core i3-6100 2C/3.7GHz/3MB/51W/DDR4-2133	Intel HD 530	1x8GB UDIMM DDR4-2133 Non- ECC	1x1TB HDD 7.2K 3.5" SATA6Gbs	HH DVD±RW	9-in-1	250W 85%	None	None	Switch	USB / USB Optical	Win10 Pro 64	3-year	No	07/16
30AT005MUS	US	Xeon E3-1245 v5 4C/3.5GHz/8MB/80W/DDR4-2133	Intel HD P530	1x8GB UDIMM DDR4-2133 ECC	1x1TB HDD 7.2K 3.5" SATA6Gbs	HH DVD±RW	9-in-1	250W 85%	None	None	Switch	USB / USB Optical	Win10 Pro 64	3-year	No	07/16
30AT005NUS	US	Xeon E3-1240 v5 4C/3.5GHz/8MB/80W/DDR4-2133	NVIDIA Quadro K620 2GB	1x8GB UDIMM DDR4-2133 ECC	1x1TB HDD 7.2K 3.5" SATA6Gbs	HH DVD±RW	9-in-1	250W 85%	None	None	Switch	USB / USB Optical	Win10 Pro 64	3-year	No	07/16
30AT005PUS	US	Core i7-6700 4C/3.4GHz/8MB/65W/DDR4-2133	Intel HD 530+NVIDIA Quadro M2000 4GB	1x8GB UDIMM DDR4-2133 Non- ECC	1x256GB SSD 2.5" SATA6Gbs Opal	HH DVD±RW	9-in-1	250W 85%	None	None	Switch	USB / USB Optical	Win10 Pro 64	3-year	No	07/16
30AT006PUS	US	Core i7-6700 4C/3.4GHz/8MB/65W/DDR4-2133	Intel HD 530+NVIDIA Quadro K1200 4GB	2x8GB UDIMM DDR4-2133 Non- ECC	1x512GB SSD 2.5" SATA6Gbs	HH DVD±RW	9-in-1	250W 85%	None	None	Switch	USB / USB Optical	Win10 DG Win7 Pro 64	3-year	No	11/16
30AT006QUS	US	Core i7-6700 4C/3.4GHz/8MB/65W/DDR4-2133	Intel HD 530+NVIDIA Quadro K620 2GB	2x8GB UDIMM DDR4-2133 Non- ECC	1x512GB SSD M.2 PCIe	HH DVD±RW	9-in-1	250W 85%	None	None	Switch	USB / USB Optical	Win10 DG Win7 Pro 64	3-year	No	11/16
30AT006RUS	US	Core i7-6700 4C/3.4GHz/8MB/65W/DDR4-2133	Intel HD 530+NVIDIA Quadro K620 2GB	2x8GB UDIMM DDR4-2133 Non- ECC	1x256GB SSD M.2 PCIe Opal	HH DVD±RW	9-in-1	250W 85%	None	None	Switch	USB / USB Optical	Win10 DG Win7 Pro 64	3-year	No	11/16
30AT006SUS	US	Core i7-6700 4C/3.4GHz/8MB/65W/DDR4-2133	Intel HD 530+NVIDIA NVS 510 2GB	2x8GB UDIMM DDR4-2133 Non- ECC	1x512GB SSD 2.5" SATA6Gbs	HH DVD±RW	9-in-1	250W 85%	None	None	Switch	USB / USB Optical	Win10 DG Win7 Pro 64	3-year	No	11/16
30AT006TUS	US	Core i7-6700 4C/3.4GHz/8MB/65W/DDR4-2133	Intel HD 530+NVIDIA Quadro K1200 4GB	2x8GB UDIMM DDR4-2133 Non- ECC	1x512GB SSD M.2 PCIe	HH DVD±RW	9-in-1	250W 85%	None	None	Switch	USB / USB Optical	Win10 DG Win7 Pro 64	3-year	No	11/16
30AT006UUS	US	Core i7-6700 4C/3.4GHz/8MB/65W/DDR4-2133	Intel HD 530+NVIDIA Quadro M2000 4GB	2x8GB UDIMM DDR4-2133 Non- ECC	1x512GB SSD M.2 PCIe	HH DVD±RW	9-in-1	250W 85%	None	None	Switch	USB / USB Optical	Win10 DG Win7 Pro 64	3-year	No	11/16

Model	Region	Processor	Graphics	Memory (Capacity/Type)	Storage (Capacity/Type/Interface)	Optical	Media Reader	Power Supply	Add-on Ports	Discrete Ethernet	Chassis Intrusion Switch	Keyboard / Mouse	Operating System	Warranty	Global	Ann Date (mm/yy)
30AT006VUS	US	Core i7-6700 4C/3.4GHz/8MB/65W/DDR4-2133	Intel HD 530+NVIDIA Quadro M2000 4GB	1x16GB UDIMM DDR4-2133 Non- ECC	1x256GB SSD 2.5" SATA6Gbs Opal	HH DVD±RW	9-in-1	250W 85%	None	None	Switch	USB / USB Optical	Win10 DG Win7 Pro 64	3-year	No	11/16
30ATA023US	US	Core i7-6700 4C/3.4GHz/8MB/65W/DDR4-2133	Intel HD 530	2x8GB UDIMM DDR4-2133 Non- ECC	1x512GB SSD 2.5" SATA6Gbs	HH DVD±RW	9-in-1	250W 85%	None	None	Switch	USB / USB Optical	Win10 DG Win7 Pro 64	3-year	No	11/16

ThinkStation P410 Platform Specifications

Product Specifications Reference (PSREF)

Components	Specification					
Chipset	Intel C612 Platform Controller Hub (PCH)					
System mgmt	Intel Active Management Technology 9					
Processor	Up to one 140W Intel Xeon E5-1600 v4 family processors. Some Intel Xeon E5-2600 v4 processors are also available:					
	E5-2637 v4	4C/3.5GHz/15MB/135W/DDR4-2400				
	E5-2623 v4	4C/2.6GHz/10MB/85W/DDR4-2133				
	E5-2620 v4	8C/2.1GHz/20MB/85W/DDR4-2133				
	E5-1680 v4	8C/3.4GHz/20MB/140W/DDR4-2400 333				
	E5-1660 v4	8C/3.2GHz/20MB/140W/DDR4-2400				
	E5-1650 v4	6C/3.6GHz/15MB/140W/DDR4-2400				
	E5-1630 v4	4C/3.7GHz/10MB/140W/DDR4-2400				
	E5-1620 v4	4C/3.5GHz/10MB/140W/DDR4-2400				
	E5-1607 v4	4C/3.1GHz/10MB/140W/DDR4-2133				
E5-1603 v4	4C/2.8GHz/10MB/140W/DDR4-2133					
Coprocessor	None					
Memory DIMM slots	4 DIMM sockets. 4-channel capable. RDIMM. ECC. DDR4-2400					
Memory capacity	128GB (32GB x 4)					
Graphics	Two PCIe 3.0 x16 slots, up to two NVIDIA Quadro M4000, or up to one Quadro P5000					
Supporting Graphics and GPU computing	Adapter	Cores	Memory	Power	SLI	Connector***
	NVS 310	48	1GB	19.5W		2xDP
	NVS 315	48	1GB	19.5W		2xDVI-I SLI/2xDP
	NVS 510	192	2GB	35W		4xmini DP
	NVS 810	1024	4GB	68W		8xmini DP
	Quadro K420	192	2GB	41W		DVI-I DL+DP
	Quadro K620	384	2GB	45W		DVI-I DL+DP
	Quadro K1200	512	4GB	45W		4xmini DP
	Quadro M2000	768	4GB	75W		4xDP
	Quadro M4000	1664	8GB	120W		4xDP
	Quadro M5000	2048	8GB	150W		DVI-I DL+4xDP
Quadro P5000	2560	16GB	180W		DVI-D DL+4xDP	
Disk drive controller	RAID 0, 1, 5, 10 with onboard SATA controller in chipset, SATA 6Gb/s. Optional RAID 0, 1, 10 with optional LSI 9340-8i PCIe adapter, 12Gb/s SAS and SATA, optional upgrade to RAID 5 is available					
Drive Bays	Two external 5.25" flex bays, two internal 3.5" bays. Up to one 9.5mm optical plus four 3.5"/2.5" disk drives plus three M.2 PCIe SSD (see right)					
Supporting storage	3.5" HDD, 7.2K SATA6Gbs	500GB/1TB/2TB/3TB/4TB/6TB, 1TB/2TB hybrid				
	2.5" HDD, 10K SAS12Gbs	300GB/600GB				
	2.5" SSD, SATA6Gbs	180GB/240GB/256GB/480GB/512GB with OPAL, 256GB/512GB/1TB without OPAL				
	PCIe SSD, M.2 via PCIe 3.0 x4 adapter	256GB/512GB/1TB, NVMe				
Flex connector	None					
Network interfaces	One onboard gigabit ethernet, Intel I218LM, supports Wake-on-LAN. Optional discrete ethernet adapters are available					
HD Audio	Realtek ALC662 codec					
TPM	TCG 1.2-compliant					
Power supply	One fixed 450 watts, autosensing, 92%, 80 PLUS Platinum qualified					
Front ports	Two USB 3.0, microphone (3.5mm), headphone (3.5mm)					
Rear ports	Two USB 2.0, four USB 3.0, one ethernet (RJ-45), three analog audio ports (line-in, line-out, mic-in)					
Additional ports	Supports the following optional ports: Two IEEE 1394 (one on rear and one on front flex module) via PCIe adapter, up to one adapter per system. Two rear USB 3.0 per PCIe adapter, up to three adapters per system. One rear Thunderbolt via PCIe adapter, or two front Thunderbolt (on flex module) via PCIe adapter, front and rear Thunderbolt cannot be intermixed. One rear serial via cable, up to one per system. One front eSATA (on flex module), or one rear eSATA via cable and PCIe slot bracket, up to one eSATA port per system					
Media reader	9-in-1 USB 2.0 card reader. Optional 29-in-1 USB 2.0 card reader on flex module					

Components	Specification											
Mechanical	<ul style="list-style-type: none"> 6.89"W x 16.77"D x 14.8"H 175mm W x 426mm D x 376mm H 30.86 lb (14kg) max configuration 25-liter 											
	<table border="1"> <tr> <td>Temperature - operating</td> <td>50 °F to 95 °F (10 °C to 35 °C)</td> </tr> <tr> <td>Temperature - non operating (no package)</td> <td>14 °F to 140 °F (-10 °C to 60 °C)</td> </tr> <tr> <td>Temperature - non operating (with package)</td> <td>-40 °F to 140 °F (-40 °C to 60 °C)</td> </tr> <tr> <td>Altitude - operating</td> <td>(Unpressurized): 0-10000ft (0-3048m)</td> </tr> <tr> <td>Humidity - operating</td> <td>10%-80%, non-condensing</td> </tr> <tr> <td>Humidity - storage (with package)</td> <td>10%-90%, non-condensing</td> </tr> </table>	Temperature - operating	50 °F to 95 °F (10 °C to 35 °C)	Temperature - non operating (no package)	14 °F to 140 °F (-10 °C to 60 °C)	Temperature - non operating (with package)	-40 °F to 140 °F (-40 °C to 60 °C)	Altitude - operating	(Unpressurized): 0-10000ft (0-3048m)	Humidity - operating	10%-80%, non-condensing	Humidity - storage (with package)
Temperature - operating	50 °F to 95 °F (10 °C to 35 °C)											
Temperature - non operating (no package)	14 °F to 140 °F (-10 °C to 60 °C)											
Temperature - non operating (with package)	-40 °F to 140 °F (-40 °C to 60 °C)											
Altitude - operating	(Unpressurized): 0-10000ft (0-3048m)											
Humidity - operating	10%-80%, non-condensing											
Humidity - storage (with package)	10%-90%, non-condensing											
Environmental specification	RoHS-compliant, GREENGUARD on all models. EPEAT Gold rating, ENERGY STAR 6.1 qualified on selected models.											
Base warranty	1 or 3-year limited onsite service with 9x5/NBD											

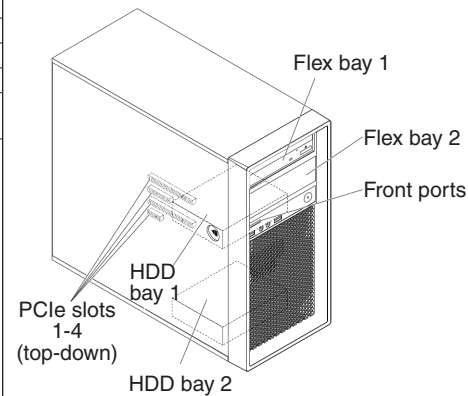

Expansion slots	
Slot 1	PCIe 3.0 x16, full length, full height
Slot 2	PCIe 3.0 x8, full length, full height
Slot 3	PCIe 3.0 x16, full length, full height
Slot 4	PCIe 2.0 x4, half length, full height

Drive Bays	
HDD bay 1	3.5", for one 3.5"/2.5" drive
HDD bay 2	3.5", for one 3.5"/2.5" drive
Flex bay 1	HH optical, or 3.5" HDD bay via optional conversion kit, or slim optical+3.5" HDD bay kit via optional conversion kit, or flex module
Flex bay 2	HH optical, or 3.5" HDD bay via optional conversion kit, or slim optical+3.5" HDD bay kit via optional conversion kit, or flex module

Note:
 1. HDD bay 2 is not available when one Quadro M5000, two Quadro M4000, or two NVS 810 are used.
 2. Flex module supports one or more of the following options: 9.5mm optical/29-in-1 USB 2.0 reader/one front IEEE 1394/one front eSATA/two front Thunderbolt. Up to one flex module is supported per system.
 3. Up to one slim optical+3.5" HDD bay kit is supported per system.

For the list of ISV certifications, please visit www.thinkworkstations.com/isv-certifications
 For a list of all supported options, please visit https://download.lenovo.com/pccbbs/options_iso/ocm_december_2016.xlsx sheet

Model	Region	Processor	Graphics	Memory (Capacity/Type)	RAID Controller	Storage (Capacity/Type/Interface)	Optical	Media Reader	Power Supply	Add-on Ports	Discrete Ethernet	Chassis Intrusion Switch	Keyboard / Mouse	Operating System	Warranty	Ann Date (mm/yy)
30B3001PUS	US	Xeon E5-1620 v4 4C/3.5GHz/10MB/140W/DDR4-2400	NVIDIA Quadro K620 2GB	1x8GB RDIMM DDR4-2400 ECC	Onboard	1x256GB SSD M.2 PCIe Opal	HH DVD±RW	9-in-1	450W 92%	None	None	Switch	USB / USB Optical	Windows 10 Pro 64	3-year	06/16
30B3001QUS	US	Xeon E5-1607 v4 4C/3.1GHz/10MB/140W/DDR4-2133	Open	1x8GB RDIMM DDR4-2400 ECC	Onboard	1x1TB HDD 7.2K 3.5" SATA6Gbs	HH DVD±RW	9-in-1	450W 92%	None	None	Switch	USB / USB Optical	Windows 10 Pro 64	3-year	06/16
30B3001RUS	US	Xeon E5-1630 v4 4C/3.7GHz/10MB/140W/DDR4-2400	NVIDIA Quadro K1200 4GB	1x8GB RDIMM DDR4-2400 ECC	Onboard	1x256GB SSD M.2 PCIe Opal	HH DVD±RW	9-in-1	450W 92%	None	None	Switch	USB / USB Optical	Windows 10 Pro 64	3-year	06/16
30B3001SUS	US	Xeon E5-1630 v4 4C/3.7GHz/10MB/140W/DDR4-2400	NVIDIA Quadro M2000 4GB	2x8GB RDIMM DDR4-2400 ECC	Onboard	1x256GB SSD 2.5" SATA6Gbs Opal	HH DVD±RW	9-in-1	450W 92%	None	None	Switch	USB / USB Optical	Windows 10 Pro 64	3-year	06/16
30B3001TUS	US	Xeon E5-1620 v4 4C/3.5GHz/10MB/140W/DDR4-2400	NVIDIA Quadro K620 2GB	2x8GB RDIMM DDR4-2400 ECC	Onboard	1x1TB SSD 2.5" SATA6Gbs	HH DVD±RW	9-in-1	450W 92%	None	None	Switch	USB / USB Optical	Windows 10 Pro 64	3-year	06/16
30B3001UUS	US	Xeon E5-1620 v4 4C/3.5GHz/10MB/140W/DDR4-2400	Open	1x8GB RDIMM DDR4-2400 ECC	Onboard	1x1TB HDD 7.2K 3.5" SATA6Gbs	HH DVD±RW	9-in-1	450W 92%	None	None	Switch	USB / USB Optical	Windows 10 Pro 64	3-year	06/16
30B3001VUS	US	Xeon E5-1650 v4 6C/3.6GHz/15MB/140W/DDR4-2400	NVIDIA Quadro M2000 4GB	2x8GB RDIMM DDR4-2400 ECC	Onboard	1x256GB SSD 2.5" SATA6Gbs Opal	HH DVD±RW	9-in-1	450W 92%	None	None	Switch	USB / USB Optical	Windows 10 Pro 64	3-year	06/16
30B3001WUS	US	Xeon E5-1620 v4 4C/3.5GHz/10MB/140W/DDR4-2400	NVIDIA Quadro K620 2GB	1x8GB RDIMM DDR4-2400 ECC	Onboard	1x1TB HDD 7.2K 3.5" SATA6Gbs	HH DVD±RW	9-in-1	450W 92%	None	None	Switch	USB / USB Optical	Windows 10 Pro 64	3-year	06/16
30B3001XUS	US	Xeon E5-1630 v4 4C/3.7GHz/10MB/140W/DDR4-2400	NVIDIA Quadro K620 2GB	2x8GB RDIMM DDR4-2400 ECC	Onboard	1x256GB SSD 2.5" SATA6Gbs Opal	HH DVD±RW	9-in-1	450W 92%	None	None	Switch	USB / USB Optical	Windows 10 Pro 64	3-year	06/16
30B3001YUS	US	Xeon E5-1650 v4 6C/3.6GHz/15MB/140W/DDR4-2400	NVIDIA Quadro M4000 8GB	2x8GB RDIMM DDR4-2400 ECC	Onboard	1x1TB SSD 2.5" SATA6Gbs	HH DVD±RW	9-in-1	450W 92%	None	None	Switch	USB / USB Optical	Windows 10 Pro 64	3-year	06/16
30B30020US	US	Xeon E5-1650 v4 6C/3.6GHz/15MB/140W/DDR4-2400	Open	2x8GB RDIMM DDR4-2400 ECC	Onboard	1x1TB HDD 7.2K 3.5" SATA6Gbs	HH DVD±RW	9-in-1	450W 92%	None	None	Switch	USB / USB Optical	Windows 10 Pro 64	3-year	06/16
30B30021US	US	Xeon E5-1620 v4 4C/3.5GHz/10MB/140W/DDR4-2400	NVIDIA Quadro K1200 4GB	1x8GB RDIMM DDR4-2400 ECC	Onboard	1x256GB SSD M.2 PCIe Opal	HH DVD±RW	9-in-1	450W 92%	None	None	Switch	USB / USB Optical	Windows 10 Pro 64	3-year	06/16
30B30022US	US	Xeon E5-1650 v4 6C/3.6GHz/15MB/140W/DDR4-2400	NVIDIA Quadro K1200 4GB	2x8GB RDIMM DDR4-2400 ECC	Onboard	1x512GB SSD M.2 PCIe	HH DVD±RW	9-in-1	450W 92%	None	None	Switch	USB / CadMouse	Windows 10 Pro 64	3-year	06/16
30B3002AUS	US	Xeon E5-1607 v4 4C/3.1GHz/10MB/140W/DDR4-2133	Open	1x8GB RDIMM DDR4-2400 ECC	Onboard	1x1TB HDD 7.2K 3.5" SATA6Gbs	HH DVD±RW	9-in-1	450W 92%	None	None	Switch	USB / USB Optical	Windows 10 DG Windows 7 Pro 64	3-year	09/16
30B3002HUS	US	Xeon E5-1620 v4 4C/3.5GHz/10MB/140W/DDR4-2400	Open	1x8GB RDIMM DDR4-2400 ECC	Onboard	1x1TB HDD 7.2K 3.5" SATA6Gbs	HH DVD±RW	9-in-1	450W 92%	None	None	Switch	USB / USB Optical	Windows 10 DG Windows 7 Pro 64	3-year	09/16

Model	Region	Processor	Graphics	Memory (Capacity/Type)	RAID Controller	Storage (Capacity/Type/Interface)	Optical	Media Reader	Power Supply	Add-on Ports	Discrete Ethernet	Chassis Intrusion Switch	Keyboard / Mouse	Operating System	Warranty	Ann Date (mm/yy)
30B3003KUS	US	Xeon E5-1620 v4 4C/3.5GHz/10MB/140W/DDR4-2400	NVIDIA Quadro K620 2GB	1x8GB RDIMM DDR4-2400 ECC	Onboard	1x256GB SSD M.2 PCIe Opal	HH DVD±RW	9-in-1	450W 92%	None	None	Switch	USB / USB Optical	Windows 10 DG Windows 7 Pro 64	3-year	09/16
30B3003LUS	US	Xeon E5-1620 v4 4C/3.5GHz/10MB/140W/DDR4-2400	NVIDIA Quadro K620 2GB	2x8GB RDIMM DDR4-2400 ECC	Onboard	1x1TB SSD 2.5" SATA6Gbs	HH DVD±RW	9-in-1	450W 92%	None	None	Switch	USB / USB Optical	Windows 10 DG Windows 7 Pro 64	3-year	09/16
30B3003MUS	US	Xeon E5-1630 v4 4C/3.7GHz/10MB/140W/DDR4-2400	NVIDIA Quadro K620 2GB	2x8GB RDIMM DDR4-2400 ECC	Onboard	1x256GB SSD 2.5" SATA6Gbs Opal	HH DVD±RW	9-in-1	450W 92%	None	None	Switch	USB / USB Optical	Windows 10 DG Windows 7 Pro 64	3-year	09/16
30B3003NUS	US	Xeon E5-1650 v4 6C/3.6GHz/15MB/140W/DDR4-2400	NVIDIA Quadro M4000 8GB	2x8GB RDIMM DDR4-2400 ECC	Onboard	1x1TB SSD 2.5" SATA6Gbs	HH DVD±RW	9-in-1	450W 92%	None	None	Switch	USB / USB Optical	Windows 10 DG Windows 7 Pro 64	3-year	09/16
30B3003PUS	US	Xeon E5-1620 v4 4C/3.5GHz/10MB/140W/DDR4-2400	NVIDIA Quadro K620 2GB	1x8GB RDIMM DDR4-2400 ECC	Onboard	1x1TB HDD 7.2K 3.5" SATA6Gbs	HH DVD±RW	9-in-1	450W 92%	None	None	Switch	USB / USB Optical	Windows 10 DG Windows 7 Pro 64	3-year	09/16
30B3003QUS	US	Xeon E5-1650 v4 6C/3.6GHz/15MB/140W/DDR4-2400	NVIDIA Quadro K1200 4GB	2x8GB RDIMM DDR4-2400 ECC	Onboard	1x512GB SSD M.2 PCIe	HH DVD±RW	9-in-1	450W 92%	None	None	Switch	USB / CadMouse	Windows 10 DG Windows 7 Pro 64	3-year	09/16
30B3003RUS	US	Xeon E5-1650 v4 6C/3.6GHz/15MB/140W/DDR4-2400	Open	2x8GB RDIMM DDR4-2400 ECC	Onboard	1x1TB HDD 7.2K 3.5" SATA6Gbs	HH DVD±RW	9-in-1	450W 92%	None	None	Switch	USB / USB Optical	Windows 10 DG Windows 7 Pro 64	3-year	09/16
30B3003SUS	US	Xeon E5-1630 v4 4C/3.7GHz/10MB/140W/DDR4-2400	NVIDIA Quadro M2000 4GB	2x8GB RDIMM DDR4-2400 ECC	Onboard	1x256GB SSD 2.5" SATA6Gbs Opal	HH DVD±RW	9-in-1	450W 92%	None	None	Switch	USB / USB Optical	Windows 10 DG Windows 7 Pro 64	3-year	09/16
30B3003TUS	US	Xeon E5-1620 v4 4C/3.5GHz/10MB/140W/DDR4-2400	NVIDIA Quadro K1200 4GB	1x8GB RDIMM DDR4-2400 ECC	Onboard	1x256GB SSD M.2 PCIe Opal	HH DVD±RW	9-in-1	450W 92%	None	None	Switch	USB / USB Optical	Windows 10 DG Windows 7 Pro 64	3-year	09/16
30B3003UUS	US	Xeon E5-1650 v4 6C/3.6GHz/15MB/140W/DDR4-2400	NVIDIA Quadro M2000 4GB	2x8GB RDIMM DDR4-2400 ECC	Onboard	1x256GB SSD 2.5" SATA6Gbs Opal	HH DVD±RW	9-in-1	450W 92%	None	None	Switch	USB / USB Optical	Windows 10 DG Windows 7 Pro 64	3-year	09/16
30B3003VUS	US	Xeon E5-1630 v4 4C/3.7GHz/10MB/140W/DDR4-2400	NVIDIA Quadro K1200 4GB	1x8GB RDIMM DDR4-2400 ECC	Onboard	1x256GB SSD M.2 PCIe Opal	HH DVD±RW	9-in-1	450W 92%	None	None	Switch	USB / USB Optical	Windows 10 DG Windows 7 Pro 64	3-year	09/16
30B3004JUS	US	Xeon E5-1630 v4 4C/3.7GHz/10MB/140W/DDR4-2400	NVIDIA Quadro M2000 4GB	2x16GB RDIMM DDR4-2400 ECC	Onboard	1x512GB SSD 2.5" SATA6Gbs+1x256GB SSD M.2 PCIe Opal	None	None	450W 92%	None	None	Switch	USB / USB Optical	Windows 10 DG Windows 7 Pro 64	3-year	09/16
30B3004MUS	US	Xeon E5-1620 v4 4C/3.5GHz/10MB/140W/DDR4-2400	NVIDIA Quadro K1200 4GB	2x8GB RDIMM DDR4-2400 ECC	Onboard	1x1TB SSD M.2 PCIe NVMe Opal	HH DVD±RW	9-in-1	450W 92%	None	None	Switch	USB / USB Optical	Windows 10 DG Windows 7 Pro 64	3-year	12/16
30B3004NUS	US	Xeon E5-1620 v4 4C/3.5GHz/10MB/140W/DDR4-2400	Open	2x8GB RDIMM DDR4-2400 ECC	Onboard	1x1TB SSD M.2 PCIe NVMe Opal	HH DVD±RW	9-in-1	450W 92%	None	None	Switch	USB / USB Optical	Windows 10 DG Windows 7 Pro 64	3-year	12/16
30B3004PUS	US	Xeon E5-1620 v4 4C/3.5GHz/10MB/140W/DDR4-2400	Open	2x8GB RDIMM DDR4-2400 ECC	Onboard	1x1TB HDD 7.2K 3.5" SATA6Gbs	HH DVD±RW	9-in-1	450W 92%	None	None	Switch	USB / USB Optical	Windows 10 DG Windows 7 Pro 64	3-year	12/16

Model	Region	Processor	Graphics	Memory (Capacity/Type)	RAID Controller	Storage (Capacity/Type/Interface)	Optical	Media Reader	Power Supply	Add-on Ports	Discrete Ethernet	Chassis Intrusion Switch	Keyboard / Mouse	Operating System	Warranty	Ann Date (mm/yy)
30B3004QUS	US	Xeon E5-1630 v4 4C/3.7GHz/10MB/140W/DDR4-2400	NVIDIA Quadro P5000 16GB	2x8GB RDIMM DDR4-2400 ECC	Onboard	1x1TB SSD M.2 PCIe NVMe Opal	HH DVD±RW	9-in-1	450W 92%	None	None	Switch	USB / USB Optical	Windows 10 DG Windows 7 Pro 64	3-year	12/16
30B3004RUS	US	Xeon E5-1620 v4 4C/3.5GHz/10MB/140W/DDR4-2400	Open	2x8GB RDIMM DDR4-2400 ECC	Onboard	1x1TB HDD 7.2K 3.5" SATA6Gbs	None	9-in-1	450W 92%	None	None	Switch	USB / USB Optical	Windows 10 DG Windows 7 Pro 64	3-year	12/16
30B3004SUS	US	Xeon E5-1630 v4 4C/3.7GHz/10MB/140W/DDR4-2400	Open	2x8GB RDIMM DDR4-2400 ECC	Onboard	1x1TB SSD M.2 PCIe NVMe Opal	HH DVD±RW	9-in-1	450W 92%	None	None	Switch	USB / USB Optical	Windows 10 DG Windows 7 Pro 64	3-year	12/16
30B3004TUS	US	Xeon E5-1650 v4 6C/3.6GHz/15MB/140W/DDR4-2400	Open	2x8GB RDIMM DDR4-2400 ECC	Onboard	1x1TB SSD M.2 PCIe NVMe Opal	HH DVD±RW	9-in-1	450W 92%	None	None	Switch	USB / USB Optical	Windows 10 DG Windows 7 Pro 64	3-year	12/16
30B3004UUS	US	Xeon E5-1620 v4 4C/3.5GHz/10MB/140W/DDR4-2400	Open	2x8GB RDIMM DDR4-2400 ECC	9340-8i PCIe	1x256GB SSD M.2 PCIe Opal	HH DVD±RW	9-in-1	450W 92%	None	None	Switch	USB / USB Optical	Windows 10 DG Windows 7 Pro 64	3-year	12/16
30B3004VUS	US	Xeon E5-1607 v4 4C/3.1GHz/10MB/140W/DDR4-2133	Open	2x8GB RDIMM DDR4-2400 ECC	Onboard	1x1TB SSD M.2 PCIe NVMe Opal	HH DVD±RW	9-in-1	450W 92%	None	None	Switch	USB / USB Optical	Windows 10 DG Windows 7 Pro 64	3-year	12/16

ThinkStation P510 Platform Specifications

Product Specifications Reference (PSREF)

Components	Specification																																																																																																												
Chipset	Intel C612 Platform Controller Hub (PCH)																																																																																																												
System mgmt	Intel Active Management Technology 9																																																																																																												
Processor	Up to one 145W Intel Xeon E5-2600 v4 or E5-1600 v4 family processors. 22 cores up to 2.2GHz, 16 cores up to 2.6GHz, 14 cores up to 2.6GHz, 12 cores up to 2.2GHz, 10 cores up to 2.4GHz, 8 cores up to 3.4GHz, 6 cores up to 3.6GHz, 4 cores up to 3.7GHz Or up to one Intel Xeon E5-2600 v3 or E5-1600 v3 processors (not available in EMEA).																																																																																																												
Coprocessor	None																																																																																																												
Memory DIMM slots	8 DIMM sockets, 4-channel capable. RDIMM, ECC, DDR4, 2400MHz																																																																																																												
Memory capacity	256GB																																																																																																												
Graphics, GPU computing	Two PCIe 3.0 x16 slots for graphics and GPU computing adapters. Up to two NVIDIA Quadro M5000 SLI																																																																																																												
Supporting Graphics and GPU computing	<table border="1"> <thead> <tr> <th>Adapter</th> <th>Cores</th> <th>Memory</th> <th>Power</th> <th>SLI</th> <th>Connector***</th> </tr> </thead> <tbody> <tr> <td>NVS 310</td> <td>48</td> <td>1GB</td> <td>19.5W</td> <td></td> <td>2xDP</td> </tr> <tr> <td>NVS 315</td> <td>48</td> <td>1GB</td> <td>19.5W</td> <td></td> <td>2xDVI-I SL/2xDP</td> </tr> <tr> <td>NVS 510</td> <td>192</td> <td>2GB</td> <td>35W</td> <td></td> <td>4xmini DP</td> </tr> <tr> <td>NVS 810</td> <td>1024</td> <td>4GB</td> <td>68W</td> <td></td> <td>8xmini DP</td> </tr> <tr> <td>Quadro K420</td> <td>192</td> <td>2GB</td> <td>41W</td> <td></td> <td>DVI-I DL+DP</td> </tr> <tr> <td>Quadro K620</td> <td>384</td> <td>2GB</td> <td>45W</td> <td></td> <td>DVI-I DL+DP</td> </tr> <tr> <td>Quadro K1200</td> <td>512</td> <td>4GB</td> <td>45W</td> <td></td> <td>4xmini DP</td> </tr> <tr> <td>Quadro K2200</td> <td>640</td> <td>4GB</td> <td>68W</td> <td></td> <td>DVI-I DL+2xDP</td> </tr> <tr> <td>Quadro K4200</td> <td>1344</td> <td>4GB</td> <td>108W</td> <td></td> <td>DVI-I DL+2xDP</td> </tr> <tr> <td>Quadro K5200</td> <td>2304</td> <td>8GB</td> <td>150W</td> <td>SLI</td> <td>DVI-I DL+DVI-D DL+2xDP</td> </tr> <tr> <td>Quadro M2000</td> <td>768</td> <td>4GB</td> <td>75W</td> <td></td> <td>4xDP</td> </tr> <tr> <td>Quadro M4000</td> <td>1664</td> <td>8GB</td> <td>120W</td> <td></td> <td>4xDP</td> </tr> <tr> <td>Quadro M5000</td> <td>2048</td> <td>8GB</td> <td>150W</td> <td>SLI</td> <td>DVI-I DL+4xDP</td> </tr> <tr> <td>Quadro M6000</td> <td>3072</td> <td>24GB</td> <td>250W</td> <td></td> <td>DVI-I DL+4xDP</td> </tr> <tr> <td>Quadro P5000</td> <td>2560</td> <td>16GB</td> <td>180W</td> <td></td> <td>DVI-D DL+4xDP</td> </tr> <tr> <td>Quadro P6000</td> <td>3840</td> <td>24GB</td> <td>250W</td> <td></td> <td>DVI-D DL+4xDP</td> </tr> <tr> <td>Tesla K40</td> <td>2880</td> <td>12GB</td> <td>235W</td> <td></td> <td></td> </tr> </tbody> </table>	Adapter	Cores	Memory	Power	SLI	Connector***	NVS 310	48	1GB	19.5W		2xDP	NVS 315	48	1GB	19.5W		2xDVI-I SL/2xDP	NVS 510	192	2GB	35W		4xmini DP	NVS 810	1024	4GB	68W		8xmini DP	Quadro K420	192	2GB	41W		DVI-I DL+DP	Quadro K620	384	2GB	45W		DVI-I DL+DP	Quadro K1200	512	4GB	45W		4xmini DP	Quadro K2200	640	4GB	68W		DVI-I DL+2xDP	Quadro K4200	1344	4GB	108W		DVI-I DL+2xDP	Quadro K5200	2304	8GB	150W	SLI	DVI-I DL+DVI-D DL+2xDP	Quadro M2000	768	4GB	75W		4xDP	Quadro M4000	1664	8GB	120W		4xDP	Quadro M5000	2048	8GB	150W	SLI	DVI-I DL+4xDP	Quadro M6000	3072	24GB	250W		DVI-I DL+4xDP	Quadro P5000	2560	16GB	180W		DVI-D DL+4xDP	Quadro P6000	3840	24GB	250W		DVI-D DL+4xDP	Tesla K40	2880	12GB	235W		
	Adapter	Cores	Memory	Power	SLI	Connector***																																																																																																							
	NVS 310	48	1GB	19.5W		2xDP																																																																																																							
	NVS 315	48	1GB	19.5W		2xDVI-I SL/2xDP																																																																																																							
	NVS 510	192	2GB	35W		4xmini DP																																																																																																							
	NVS 810	1024	4GB	68W		8xmini DP																																																																																																							
	Quadro K420	192	2GB	41W		DVI-I DL+DP																																																																																																							
	Quadro K620	384	2GB	45W		DVI-I DL+DP																																																																																																							
	Quadro K1200	512	4GB	45W		4xmini DP																																																																																																							
	Quadro K2200	640	4GB	68W		DVI-I DL+2xDP																																																																																																							
	Quadro K4200	1344	4GB	108W		DVI-I DL+2xDP																																																																																																							
	Quadro K5200	2304	8GB	150W	SLI	DVI-I DL+DVI-D DL+2xDP																																																																																																							
	Quadro M2000	768	4GB	75W		4xDP																																																																																																							
	Quadro M4000	1664	8GB	120W		4xDP																																																																																																							
	Quadro M5000	2048	8GB	150W	SLI	DVI-I DL+4xDP																																																																																																							
	Quadro M6000	3072	24GB	250W		DVI-I DL+4xDP																																																																																																							
	Quadro P5000	2560	16GB	180W		DVI-D DL+4xDP																																																																																																							
Quadro P6000	3840	24GB	250W		DVI-D DL+4xDP																																																																																																								
Tesla K40	2880	12GB	235W																																																																																																										
RAID controller	Supports one of the following: RAID 0, 1, 5, 10 with onboard SATA controller in chipset, SATA 6Gb/s. RAID 0, 1, 5, 10 with optional LSI RAID flex adapter, 12Gb/s SAS and SATA. RAID 0, 1, 5, 6, 10 with optional LSI 9364-8i PCIe adapter, 1GB memory, 12Gb/s SAS and SATA																																																																																																												
Drive Bays	Two external 5.25" flex bays for flex module, optical drives, or optional disk drives. Four 3.5" internal bays. Each 3.5" bay can support dual drives on selected models (see right).																																																																																																												
Flex bay	Two 5.25" flex bays for optical drives, Front Access Storage Enclosure drives, Flex Bay Storage Enclosure drives, or flex module. • Up to two half-height optical drives or up to one 9.5mm optical drive, DVD-ROM, DVD±RW, or Blu-Ray burner • Up to one Front Access Storage Enclosure for one 3.5" or 2.5" SATA drive. • Up to two Flex Bay Storage Enclosure for two 3.5" or 2.5" SATA drives.																																																																																																												
Supporting storage	3.5" HDD, 7.2K SATA6Gbs	500GB/1TB/2TB/3TB/4TB/6TB/1TB hybrid/2TB hybrid																																																																																																											
	2.5" HDD, 15K SAS12Gbs	300GB/600GB																																																																																																											
	2.5" SSD, SAS12Gbs	200GB/400GB/800GB																																																																																																											
	2.5" SAS HDD, 10K 12Gbs	300GB																																																																																																											
	2.5" SSD, SATA6Gbs	180GB/240GB/256GB/480GB with OPAL, 256GB/512GB/1TB without OPAL																																																																																																											
	PCIe SSD, U.2	400GB																																																																																																											
PCIe SSD, M.2	256 GB/512GB/1TB																																																																																																												
PCIe SSD adapter	400GB (up to 3 per system)																																																																																																												
Flex connector	One flex connector, supports one of the following: • Up to one LSI RAID flex adapter for SATA/SAS RAID • Up to one Multi-I/O flex adapters for one 2.5" PCIe SSD • Up to one M.2 flex adapters for one M.2 PCIe SSD																																																																																																												
Network interfaces	Integrated one Gigabit Ethernet (Intel i218LM), supports Wake-on-LAN. Optional discrete Ethernet is available																																																																																																												
HD Audio	Realtek ALC662 codec																																																																																																												
TPM	TCG 1.2-compliant																																																																																																												
Power supply	One fixed 490 watts, autosensing, 90%, 80 PLUS Gold qualified. Or one fixed 650 watts, autosensing, 92%, 80 PLUS Platinum qualified																																																																																																												

Components	Specification	
Front ports	Four USB 3.0 (one Diagnostic, one Always On), one combo audio/microphone jack (3.5mm)	
Rear ports	Four USB 2.0, four USB 3.0, one serial (9-pin), one ethernet (RJ-45), three analog audio ports (line-in, line-out, mic-in), two PS/2	
Add-on ports	Supports the following optional ports: Two IEEE 1394 (one on rear and one on front flex module) via PCIe adapter, up to one adapter per system. Two rear USB 3.0 per PCIe adapter, up to three adapters per system. One rear Thunderbolt via PCIe adapter. One front eSATA (on flex module), or one rear eSATA via cable (also needs one PCIe slot), up to one eSATA port per system. One internal USB 3.0 port via cable, cannot be intermixed with 29-in-1 reader	
Media reader	9-in-1 USB 2.0 or 29-in-1 USB 3.0 card reader	
Mechanical	<ul style="list-style-type: none"> 36-liter: 175mm/6.89" W x 470mm/18.5" D x 440mm/17.32" H (with feet) Tool-less parts: all except CPU fansink 48.94 lb (22.2kg) max configuration 	
Environmental specification	Temperature - operating	50 °F to 95 °F (10 °C to 35 °C)
	Temperature - non operating (no package)	14 °F to 140 °F (-10 °C to 60 °C)
	Temperature - non operating (with package)	-40 °F to 140 °F (-40 °C to 60 °C)
	Altitude - operating	(Unpressurized): 0-10000ft (0-3048m)
	Humidity - operating	10%-80%, non-condensing
Humidity - storage (with package)	10%-90%, non-condensing	
RoHS-compliant, GREENGUARD on all models. EPEAT Gold rating, ENERGY STAR 6.1 qualified on selected models.		
Base warranty	3-year limited onsite service with 9x5/NBD	

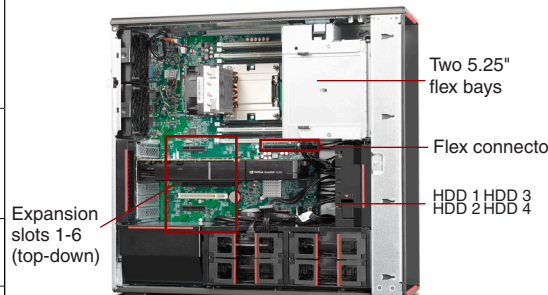

Expansion slots

- Slot 1: PCIe 3.0 x4, Half length, full height
- Slot 2: PCIe 3.0 x16, Full length, full height
- Slot 3: PCIe 2.0 x1, Full length, full height
- Slot 4: PCIe 3.0 x16, Full length, full height
- Slot 5: PCI, Full length, full height
- Slot 6: PCIe 2.0 x4, Half length, full height

Drive Bays

- HDD 1-4: Standard 3.5" HDD bay, up to four 3.5" or 2.5" disk drives.
On selected models, each 3.5" bay can support 2.5" (9mm or less) drive plus 3.5" drive, or two 2.5" (15mm or less) drives.
- Flex bay: Two 5.25" flex bays, for HH optical drives.
Or up to one optional flex module (Flex module supports one or more of the following options: 9.5mm optical/29-in-1 USB 3.0 reader/front IEEE 1394/front eSATA).
Or up to two HDD bays for two drives, 3.5" or 2.5" each, SATA only.

For the list of ISV certifications, please visit www.thinkworkstations.com/isv-certifications
For a list of all supported options, please visit https://download.lenovo.com/pccbbs/options_iso/ocm_december_2016.xlsx sheet

Model	Region	Processor	Graphics	Memory (Capacity/Type)	RAID Controller	Max Drives in 3.5" Bays	Storage (Capacity/Type/Interface)	Optical	Media Reader	Power Supply	Add-on Ports	Discrete Ethernet	Keyboard / Mouse	Operating System	Warranty	Ann Date (mm/yy)
30B5000VUS	US	Xeon E5-1650 v4 6C/3.6GHz/ 15MB/140W/DDR4-2400	Open	1x8GB RDIMM DDR4-2400 ECC	Onboard	4	1x1TB HDD 7.2K 3.5" SATA6Gbs	HH DVD±RW	9-in-1	650W 92%	None	None	USB / USB Optical	Windows 10 Pro 64	3-year	06/16
30B50019US	US	Xeon E5-1630 v4 4C/3.7GHz/ 10MB/140W/DDR4-2400	Open	2x8GB RDIMM DDR4-2400 ECC	Onboard	4	1x256GB SSD 2.5" SATA6Gbs Opal	HH DVD±RW	9-in-1	650W 92%	None	None	USB / USB Optical	Windows 10 Pro 64	3-year	06/16
30B5001GUS	US	Xeon E5-1620 v4 4C/3.5GHz/ 10MB/140W/DDR4-2400	NVIDIA Quadro M2000 4GB	1x8GB RDIMM DDR4-2400 ECC	Onboard	4	1x1TB HDD 7.2K 3.5" SATA6Gbs	HH DVD±RW	9-in-1	490W 90%	None	None	USB / USB Optical	Windows 10 Pro 64	3-year	06/16
30B5001HUS	US	Xeon E5-1620 v4 4C/3.5GHz/ 10MB/140W/DDR4-2400	Open	1x8GB RDIMM DDR4-2400 ECC	Onboard	4	1x1TB HDD 7.2K 3.5" SATA6Gbs	HH DVD±RW	9-in-1	650W 92%	None	None	USB / USB Optical	Windows 10 Pro 64	3-year	06/16
30B5001JUS	US	Xeon E5-1620 v4 4C/3.5GHz/ 10MB/140W/DDR4-2400	NVIDIA Quadro M2000 4GB	2x8GB RDIMM DDR4-2400 ECC	Onboard	4	1x512GB SSD 2.5" SATA6Gbs	HH DVD±RW	9-in-1	490W 90%	None	None	USB / USB Optical	Windows 10 Pro 64	3-year	06/16
30B5001KUS	US	Xeon E5-1620 v4 4C/3.5GHz/ 10MB/140W/DDR4-2400	Open	1x8GB RDIMM DDR4-2400 ECC	Onboard	4	1x1TB HDD 7.2K 3.5" SATA6Gbs	HH DVD±RW	9-in-1	490W 90%	None	None	USB / USB Optical	Windows 10 Pro 64	3-year	06/16
30B5001LUS	US	Xeon E5-1607 v4 4C/3.1GHz/ 10MB/140W/DDR4-2133	NVIDIA Quadro K620 2GB	1x8GB RDIMM DDR4-2400 ECC	Onboard	4	1x1TB HDD 7.2K 3.5" SATA6Gbs	HH DVD±RW	9-in-1	490W 90%	None	None	USB / USB Optical	Windows 10 Pro 64	3-year	06/16
30B5001MUS	US	Xeon E5-1607 v4 4C/3.1GHz/ 10MB/140W/DDR4-2133	NVIDIA Quadro K620 2GB	1x8GB RDIMM DDR4-2400 ECC	Onboard	4	1x500GB HDD 7.2K 3.5" SATA6Gbs	HH DVD±RW	9-in-1	490W 90%	None	None	USB / USB Optical	Windows 10 Pro 64	3-year	06/16
30B5001NUS	US	Xeon E5-1630 v4 4C/3.7GHz/ 10MB/140W/DDR4-2400	NVIDIA Quadro M4000 8GB	2x8GB RDIMM DDR4-2400 ECC	Onboard	4	1x512GB SSD 2.5" SATA6Gbs	HH DVD±RW	9-in-1	650W 92%	None	None	USB / USB Optical	Windows 10 Pro 64	3-year	06/16
30B5001PUS	US	Xeon E5-1607 v4 4C/3.1GHz/ 10MB/140W/DDR4-2133	Open	1x8GB RDIMM DDR4-2400 ECC	Onboard	4	1x1TB HDD 7.2K 3.5" SATA6Gbs	HH DVD±RW	9-in-1	490W 90%	None	None	USB / USB Optical	Windows 10 Pro 64	3-year	06/16
30B5001QUS	US	Xeon E5-1630 v4 4C/3.7GHz/ 10MB/140W/DDR4-2400	NVIDIA Quadro M4000 8GB	2x8GB RDIMM DDR4-2400 ECC	Onboard	4	1x1TB HDD 7.2K 3.5" SATA6Gbs	HH DVD±RW	9-in-1	650W 92%	None	None	USB / USB Optical	Windows 10 Pro 64	3-year	06/16
30B50022US	US	Xeon E5-1650 v4 6C/3.6GHz/ 15MB/140W/DDR4-2400	Open	1x8GB RDIMM DDR4-2400 ECC	Onboard	4	1x1TB HDD 7.2K 3.5" SATA6Gbs	HH DVD±RW	9-in-1	650W 92%	None	None	USB / USB Optical	Windows 10 DG Windows 7 Pro 64	3-year	09/16
30B5002EUS	US	Xeon E5-1630 v4 4C/3.7GHz/ 10MB/140W/DDR4-2400	Open	2x8GB RDIMM DDR4-2400 ECC	Onboard	4	1x256GB SSD 2.5" SATA6Gbs Opal	HH DVD±RW	9-in-1	650W 92%	None	None	USB / USB Optical	Windows 10 DG Windows 7 Pro 64	3-year	09/16
30B5002TUS	US	Xeon E5-1620 v4 4C/3.5GHz/ 10MB/140W/DDR4-2400	NVIDIA Quadro K620 2GB	1x8GB RDIMM DDR4-2400 ECC	Onboard	4	1x1TB HDD 7.2K 3.5" SATA6Gbs	HH DVD±RW	9-in-1	490W 90%	None	None	USB / USB Optical	Windows 10 Pro 64	3-year	06/16
30B5002UUS	US	Xeon E5-1630 v4 4C/3.7GHz/ 10MB/140W/DDR4-2400	Open	1x8GB RDIMM DDR4-2400 ECC	Onboard	4	1x256GB SSD 2.5" SATA6Gbs Opal	HH DVD±RW	9-in-1	490W 90%	None	None	USB / USB Optical	Windows 10 Pro 64	3-year	06/16

Model	Region	Processor	Graphics	Memory (Capacity/Type)	RAID Controller	Max Drives in 3.5" Bays	Storage (Capacity/Type/Interface)	Optical	Media Reader	Power Supply	Add-on Ports	Discrete Ethernet	Keyboard / Mouse	Operating System	Warranty	Ann Date (mm/yy)
30B5002VUS	US	Xeon E5-1630 v4 4C/3.7GHz/10MB/140W/DDR4-2400	NVIDIA Quadro K1200 4GB	1x8GB RDIMM DDR4-2400 ECC	Onboard	4	1x256GB SSD 2.5" SATA6Gbs Opal	HH DVD±RW	9-in-1	490W 90%	None	None	USB / USB Optical	Windows 10 Pro 64	3-year	06/16
30B5002WUS	US	Xeon E5-1630 v4 4C/3.7GHz/10MB/140W/DDR4-2400	NVIDIA Quadro M2000 4GB	1x8GB RDIMM DDR4-2400 ECC	Onboard	4	1x256GB SSD 2.5" SATA6Gbs Opal	HH DVD±RW	9-in-1	490W 90%	None	None	USB / USB Optical	Windows 10 Pro 64	3-year	06/16
30B5002XUS	US	Xeon E5-1630 v4 4C/3.7GHz/10MB/140W/DDR4-2400	NVIDIA Quadro K1200 4GB	1x8GB RDIMM DDR4-2400 ECC	Onboard	4	1x1TB HDD 7.2K 3.5" SATA6Gbs	HH DVD±RW	9-in-1	490W 90%	None	None	USB / USB Optical	Windows 10 Pro 64	3-year	06/16
30B5002YUS	US	Xeon E5-1620 v4 4C/3.5GHz/10MB/140W/DDR4-2400	NVIDIA Quadro M4000 8GB	2x8GB RDIMM DDR4-2400 ECC	Onboard	4	1x1TB HDD 7.2K 3.5" SATA6Gbs	HH DVD±RW	9-in-1	650W 92%	None	None	USB / USB Optical	Windows 10 Pro 64	3-year	06/16
30B50030US	US	Xeon E5-1630 v4 4C/3.7GHz/10MB/140W/DDR4-2400	Open	1x8GB RDIMM DDR4-2400 ECC	Onboard	4	1x256GB SSD 2.5" SATA6Gbs Opal	HH DVD±RW	9-in-1	650W 92%	None	None	USB / USB Optical	Windows 10 Pro 64	3-year	06/16
30B50031US	US	Xeon E5-1630 v4 4C/3.7GHz/10MB/140W/DDR4-2400	NVIDIA Quadro M2000 4GB	1x8GB RDIMM DDR4-2400 ECC	Onboard	4	1x256GB SSD 2.5" SATA6Gbs Opal	HH DVD±RW	9-in-1	650W 92%	None	None	USB / USB Optical	Windows 10 Pro 64	3-year	06/16
30B50032US	US	Xeon E5-1650 v4 6C/3.6GHz/15MB/140W/DDR4-2400	Open	2x8GB RDIMM DDR4-2400 ECC	Onboard	4	1x256GB SSD 2.5" SATA6Gbs Opal	HH DVD±RW	9-in-1	650W 92%	None	None	USB / USB Optical	Windows 10 Pro 64	3-year	06/16
30B50033US	US	Xeon E5-1650 v4 6C/3.6GHz/15MB/140W/DDR4-2400	NVIDIA Quadro M2000 4GB	2x8GB RDIMM DDR4-2400 ECC	Onboard	4	1x1TB HDD 7.2K 3.5" SATA6Gbs	HH DVD±RW	9-in-1	650W 92%	None	None	USB / USB Optical	Windows 10 Pro 64	3-year	06/16
30B50034US	US	Xeon E5-1650 v4 6C/3.6GHz/15MB/140W/DDR4-2400	NVIDIA Quadro M4000 8GB	2x8GB RDIMM DDR4-2400 ECC	Onboard	4	1x1TB HDD 7.2K 3.5" SATA6Gbs	HH DVD±RW	9-in-1	650W 92%	None	None	USB / USB Optical	Windows 10 Pro 64	3-year	06/16
30B50035US	US	Xeon E5-1650 v4 6C/3.6GHz/15MB/140W/DDR4-2400	NVIDIA Quadro M4000 8GB	2x8GB RDIMM DDR4-2400 ECC	Onboard	4	1x512GB SSD 2.5" SATA6Gbs	HH DVD±RW	9-in-1	650W 92%	None	None	USB / USB Optical	Windows 10 Pro 64	3-year	06/16
30B50036US	US	Xeon E5-1650 v4 6C/3.6GHz/15MB/140W/DDR4-2400	NVIDIA Quadro M5000 8GB	2x8GB RDIMM DDR4-2400 ECC	Onboard	4	1x512GB SSD 2.5" SATA6Gbs	HH DVD±RW	9-in-1	650W 92%	None	None	USB / USB Optical	Windows 10 Pro 64	3-year	06/16
30B5003KUS	US	Xeon E5-1607 v4 4C/3.1GHz/10MB/140W/DDR4-2133	Open	1x8GB RDIMM DDR4-2400 ECC	Onboard	4	1x1TB HDD 7.2K 3.5" SATA6Gbs	HH DVD±RW	9-in-1	490W 90%	None	None	USB / USB Optical	Windows 10 DG Windows 7 Pro 64	3-year	09/16
30B5003NUS	US	Xeon E5-1620 v4 4C/3.5GHz/10MB/140W/DDR4-2400	NVIDIA Quadro M4000 8GB	2x8GB RDIMM DDR4-2400 ECC	Onboard	4	1x1TB HDD 7.2K 3.5" SATA6Gbs	HH DVD±RW	9-in-1	650W 92%	None	None	USB / USB Optical	Windows 10 DG Windows 7 Pro 64	3-year	09/16
30B5003UUS	US	Xeon E5-1620 v4 4C/3.5GHz/10MB/140W/DDR4-2400	Open	1x8GB RDIMM DDR4-2400 ECC	Onboard	4	1x1TB HDD 7.2K 3.5" SATA6Gbs	HH DVD±RW	9-in-1	490W 90%	None	None	USB / USB Optical	Windows 10 DG Windows 7 Pro 64	3-year	09/16
30B5004YUS	US	Xeon E5-1630 v4 4C/3.7GHz/10MB/140W/DDR4-2400	NVIDIA Quadro M4000 8GB	2x8GB RDIMM DDR4-2400 ECC	Onboard	4	1x1TB HDD 7.2K 3.5" SATA6Gbs	HH DVD±RW	9-in-1	650W 92%	None	None	USB / USB Optical	Windows 10 DG Windows 7 Pro 64	3-year	09/16

Model	Region	Processor	Graphics	Memory (Capacity/Type)	RAID Controller	Max Drives in 3.5" Bays	Storage (Capacity/Type/Interface)	Optical	Media Reader	Power Supply	Add-on Ports	Discrete Ethernet	Keyboard / Mouse	Operating System	Warranty	Ann Date (mm/yy)
30B50050US	US	Xeon E5-1630 v4 4C/3.7GHz/ 10MB/140W/DDR4-2400	NVIDIA Quadro M4000 8GB	2x8GB RDIMM DDR4-2400 ECC	Onboard	4	1x512GB SSD 2.5" SATA6Gbs	HH DVD±RW	9-in-1	650W 92%	None	None	USB / USB Optical	Windows 10 DG Windows 7 Pro 64	3-year	09/16
30B50051US	US	Xeon E5-1620 v4 4C/3.5GHz/ 10MB/140W/DDR4-2400	NVIDIA Quadro M2000 4GB	2x8GB RDIMM DDR4-2400 ECC	Onboard	4	1x512GB SSD 2.5" SATA6Gbs	HH DVD±RW	9-in-1	490W 90%	None	None	USB / USB Optical	Windows 10 DG Windows 7 Pro 64	3-year	09/16
30B50052US	US	Xeon E5-1607 v4 4C/3.1GHz/ 10MB/140W/DDR4-2133	NVIDIA Quadro K620 2GB	1x8GB RDIMM DDR4-2400 ECC	Onboard	4	1x500GB HDD 7.2K 3.5" SATA6Gbs	HH DVD±RW	9-in-1	490W 90%	None	None	USB / USB Optical	Windows 10 DG Windows 7 Pro 64	3-year	09/16
30B50053US	US	Xeon E5-1620 v4 4C/3.5GHz/ 10MB/140W/DDR4-2400	Open	1x8GB RDIMM DDR4-2400 ECC	Onboard	4	1x1TB HDD 7.2K 3.5" SATA6Gbs	HH DVD±RW	9-in-1	650W 92%	None	None	USB / USB Optical	Windows 10 DG Windows 7 Pro 64	3-year	09/16
30B50054US	US	Xeon E5-1607 v4 4C/3.1GHz/ 10MB/140W/DDR4-2133	NVIDIA Quadro K620 2GB	1x8GB RDIMM DDR4-2400 ECC	Onboard	4	1x1TB HDD 7.2K 3.5" SATA6Gbs	HH DVD±RW	9-in-1	490W 90%	None	None	USB / USB Optical	Windows 10 DG Windows 7 Pro 64	3-year	09/16
30B50055US	US	Xeon E5-1620 v4 4C/3.5GHz/ 10MB/140W/DDR4-2400	NVIDIA Quadro M2000 4GB	1x8GB RDIMM DDR4-2400 ECC	Onboard	4	1x1TB HDD 7.2K 3.5" SATA6Gbs	HH DVD±RW	9-in-1	490W 90%	None	None	USB / USB Optical	Windows 10 DG Windows 7 Pro 64	3-year	09/16
30B50056US	US	Xeon E5-1650 v4 6C/3.6GHz/ 15MB/140W/DDR4-2400	NVIDIA Quadro M4000 8GB	2x8GB RDIMM DDR4-2400 ECC	Onboard	4	1x1TB HDD 7.2K 3.5" SATA6Gbs	HH DVD±RW	9-in-1	650W 92%	None	None	USB / USB Optical	Windows 10 DG Windows 7 Pro 64	3-year	09/16
30B50057US	US	Xeon E5-1630 v4 4C/3.7GHz/ 10MB/140W/DDR4-2400	NVIDIA Quadro K1200 4GB	1x8GB RDIMM DDR4-2400 ECC	Onboard	4	1x1TB HDD 7.2K 3.5" SATA6Gbs	HH DVD±RW	9-in-1	490W 90%	None	None	USB / USB Optical	Windows 10 DG Windows 7 Pro 64	3-year	09/16
30B50058US	US	Xeon E5-1630 v4 4C/3.7GHz/ 10MB/140W/DDR4-2400	Open	1x8GB RDIMM DDR4-2400 ECC	Onboard	4	1x256GB SSD 2.5" SATA6Gbs Opal	HH DVD±RW	9-in-1	490W 90%	None	None	USB / USB Optical	Windows 10 DG Windows 7 Pro 64	3-year	09/16
30B50059US	US	Xeon E5-1630 v4 4C/3.7GHz/ 10MB/140W/DDR4-2400	NVIDIA Quadro M2000 4GB	1x8GB RDIMM DDR4-2400 ECC	Onboard	4	1x256GB SSD 2.5" SATA6Gbs Opal	HH DVD±RW	9-in-1	490W 90%	None	None	USB / USB Optical	Windows 10 DG Windows 7 Pro 64	3-year	09/16
30B5005AUS	US	Xeon E5-1650 v4 6C/3.6GHz/ 15MB/140W/DDR4-2400	NVIDIA Quadro M5000 8GB	2x8GB RDIMM DDR4-2400 ECC	Onboard	4	1x512GB SSD 2.5" SATA6Gbs	HH DVD±RW	9-in-1	650W 92%	None	None	USB / USB Optical	Windows 10 DG Windows 7 Pro 64	3-year	09/16
30B5005BUS	US	Xeon E5-1630 v4 4C/3.7GHz/ 10MB/140W/DDR4-2400	NVIDIA Quadro K1200 4GB	1x8GB RDIMM DDR4-2400 ECC	Onboard	4	1x256GB SSD 2.5" SATA6Gbs Opal	HH DVD±RW	9-in-1	490W 90%	None	None	USB / USB Optical	Windows 10 DG Windows 7 Pro 64	3-year	09/16
30B5005CUS	US	Xeon E5-1650 v4 6C/3.6GHz/ 15MB/140W/DDR4-2400	NVIDIA Quadro M2000 4GB	2x8GB RDIMM DDR4-2400 ECC	Onboard	4	1x1TB HDD 7.2K 3.5" SATA6Gbs	HH DVD±RW	9-in-1	650W 92%	None	None	USB / USB Optical	Windows 10 DG Windows 7 Pro 64	3-year	09/16
30B5005DUS	US	Xeon E5-1630 v4 4C/3.7GHz/ 10MB/140W/DDR4-2400	Open	1x8GB RDIMM DDR4-2400 ECC	Onboard	4	1x256GB SSD 2.5" SATA6Gbs Opal	HH DVD±RW	9-in-1	650W 92%	None	None	USB / USB Optical	Windows 10 DG Windows 7 Pro 64	3-year	09/16
30B5005EUS	US	Xeon E5-1650 v4 6C/3.6GHz/ 15MB/140W/DDR4-2400	Open	2x8GB RDIMM DDR4-2400 ECC	Onboard	4	1x256GB SSD 2.5" SATA6Gbs Opal	HH DVD±RW	9-in-1	650W 92%	None	None	USB / USB Optical	Windows 10 DG Windows 7 Pro 64	3-year	09/16

Model	Region	Processor	Graphics	Memory (Capacity/Type)	RAID Controller	Max Drives in 3.5" Bays	Storage (Capacity/Type/Interface)	Optical	Media Reader	Power Supply	Add-on Ports	Discrete Ethernet	Keyboard / Mouse	Operating System	Warranty	Ann Date (mm/yy)
30B5005FUS	US	Xeon E5-1650 v4 6C/3.6GHz/ 15MB/140W/DDR4-2400	NVIDIA Quadro M4000 8GB	2x8GB RDIMM DDR4-2400 ECC	Onboard	4	1x512GB SSD 2.5" SATA6Gbs	HH DVD±RW	9-in-1	650W 92%	None	None	USB / USB Optical	Windows 10 DG Windows 7 Pro 64	3-year	09/16
30B5005GUS	US	Xeon E5-1620 v4 4C/3.5GHz/ 10MB/140W/DDR4-2400	NVIDIA Quadro K620 2GB	1x8GB RDIMM DDR4-2400 ECC	Onboard	4	1x1TB HDD 7.2K 3.5" SATA6Gbs	HH DVD±RW	9-in-1	490W 90%	None	None	USB / USB Optical	Windows 10 DG Windows 7 Pro 64	3-year	09/16
30B5005HUS	US	Xeon E5-1630 v4 4C/3.7GHz/ 10MB/140W/DDR4-2400	NVIDIA Quadro M2000 4GB	1x8GB RDIMM DDR4-2400 ECC	Onboard	4	1x256GB SSD 2.5" SATA6Gbs Opal	HH DVD±RW	9-in-1	650W 92%	None	None	USB / USB Optical	Windows 10 DG Windows 7 Pro 64	3-year	09/16
30B5005KUS	US	Xeon E5-1620 v4 4C/3.5GHz/ 10MB/140W/DDR4-2400	Open	2x8GB RDIMM DDR4-2400 ECC	9364-8i PCIe	4	1x1TB SSD M.2 PCIe NVMe Opal	HH DVD±RW	9-in-1	650W 92%	None	None	USB / USB Optical	Windows 10 DG Windows 7 Pro 64	3-year	12/16
30B5005LUS	US	Xeon E5-1650 v4 6C/3.6GHz/ 15MB/140W/DDR4-2400	Open	2x8GB RDIMM DDR4-2400 ECC	Onboard	4	1x1TB SSD M.2 PCIe NVMe Opal	HH DVD±RW	9-in-1	650W 92%	None	None	USB / USB Optical	Windows 10 DG Windows 7 Pro 64	3-year	12/16
30B5005MUS	US	Xeon E5-1620 v4 4C/3.5GHz/ 10MB/140W/DDR4-2400	Open	2x8GB RDIMM DDR4-2400 ECC	Onboard	4	1x1TB SSD M.2 PCIe NVMe Opal	HH DVD±RW	9-in-1	650W 92%	None	None	USB / USB Optical	Windows 10 DG Windows 7 Pro 64	3-year	12/16
30B5005NUS	US	Xeon E5-1607 v4 4C/3.1GHz/ 10MB/140W/DDR4-2133	Open	2x8GB RDIMM DDR4-2400 ECC	Onboard	4	1x1TB SSD M.2 PCIe NVMe Opal	HH DVD±RW	9-in-1	650W 92%	None	None	USB / USB Optical	Windows 10 DG Windows 7 Pro 64	3-year	12/16
30B5005PUS	US	Xeon E5-1607 v4 4C/3.1GHz/ 10MB/140W/DDR4-2133	NVIDIA Quadro P5000 16GB	2x8GB RDIMM DDR4-2400 ECC	Onboard	4	1x1TB SSD M.2 PCIe NVMe Opal	HH DVD±RW	9-in-1	650W 92%	None	None	USB / USB Optical	Windows 10 DG Windows 7 Pro 64	3-year	12/16
30B5005QUS	US	Xeon E5-1650 v4 6C/3.6GHz/ 15MB/140W/DDR4-2400	NVIDIA Quadro P5000 16GB	2x8GB RDIMM DDR4-2400 ECC	Onboard	4	1x1TB SSD M.2 PCIe NVMe Opal	HH DVD±RW	9-in-1	650W 92%	None	None	USB / USB Optical	Windows 10 DG Windows 7 Pro 64	3-year	12/16
30B5005RUS	US	Xeon E5-1630 v4 4C/3.7GHz/ 10MB/140W/DDR4-2400	Open	2x8GB RDIMM DDR4-2400 ECC	Onboard	4	1x1TB SSD M.2 PCIe NVMe Opal	HH DVD±RW	9-in-1	650W 92%	None	None	USB / USB Optical	Windows 10 DG Windows 7 Pro 64	3-year	12/16
30B5005SUS	US	Xeon E5-1620 v4 4C/3.5GHz/ 10MB/140W/DDR4-2400	Open	2x8GB RDIMM DDR4-2400 ECC	Onboard	4	1x1TB SSD M.2 PCIe NVMe Opal	HH DVD±RW	9-in-1	650W 92%	None	None	USB / USB Optical	Windows 10 DG Windows 7 Pro 64	3-year	12/16

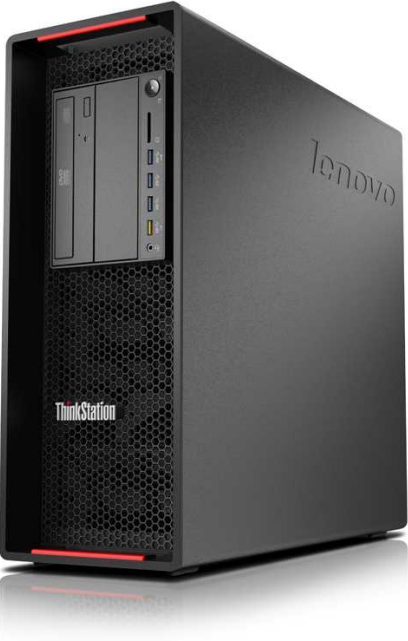

ThinkStation P700 Platform Specifications

Components	Specification
Chipset	Intel C612 Platform Controller Hub (PCH)
System mgmt	Intel Active Management Technology 9
Processor	Up to two 145W Intel Xeon E5-2600 v3 family processors, Or up to one 140W Intel Xeon E5-1600 v3 family processor:
	E5-2699 v3 18C/2.3GHz/45MB/145W/DDR4-2133
	E5-2698 v3 16C/2.3GHz/40MB/135W/DDR4-2133
	E5-2697 v3 14C/2.6GHz/35MB/145W/DDR4-2133
	E5-2695 v3 14C/2.3GHz/35MB/120W/DDR4-2133
	E5-2690 v3 12C/2.6GHz/30MB/135W/DDR4-2133
	E5-2685 v3 12C/2.6GHz/30MB/120W/DDR4-2133
	E5-2683 v3 14C/2GHz/35MB/120W/DDR4-2133
	E5-2680 v3 12C/2.5GHz/30MB/120W/DDR4-2133
	E5-2670 v3 12C/2.3GHz/30MB/120W/DDR4-2133
	E5-2667 v3 8C/3.2GHz/20MB/135W/DDR4-2133
	E5-2660 v3 10C/2.6GHz/25MB/105W/DDR4-2133
	E5-2650L v3 12C/1.8GHz/30MB/65W/DDR4-2133
	E5-2650 v3 10C/2.3GHz/25MB/105W/DDR4-2133
	E5-2643 v3 6C/3.4GHz/20MB/135W/DDR4-2133
	E5-2640 v3 8C/2.6GHz/20MB/90W/DDR4-1866
	E5-2637 v3 4C/3.5GHz/15MB/135W/DDR4-2133
	E5-2630L v3 8C/1.8GHz/20MB/55W/DDR4-1866
	E5-2630 v3 8C/2.4GHz/20MB/85W/DDR4-1866
	E5-2623 v3 4C/3GHz/10MB/105W/DDR4-1866
	E5-2620 v3 6C/2.4GHz/15MB/85W/DDR4-1866
	E5-2609 v3 6C/1.9GHz/15MB/85W/DDR4-1600
	E5-2603 v3 6C/1.6GHz/15MB/85W/DDR4-1600
	E5-1680 v3 8C/3.2GHz/20MB/140W/DDR4-2133
	E5-1660 v3 8C/3GHz/20MB/140W/DDR4-2133
E5-1650 v3 6C/3.5GHz/15MB/140W/DDR4-2133	
E5-1630 v3 4C/3.7GHz/10MB/140W/DDR4-2133	
E5-1620 v3 4C/3.5GHz/10MB/140W/DDR4-2133	
E5-1607 v3 4C/3.1GHz/10MB/140W/DDR4-1866	
E5-1603 v3 4C/2.8GHz/10MB/140W/DDR4-1866	
Coprocessor	None
Memory DIMM slots	12 DIMM sockets (6 DIMMs per processor), 8-channel capable (4-channel per processor). Supports RDIMM and LRDIMM (cannot be intermixed), ECC, DDR4-2133.
Memory capacity	768GB (LRDIMM)/384GB, 2nd CPU is needed
Graphics, GPU computing, coprocessors	Three PCIe 3.0 x16 slots, two via CPU1, one via CPU2 Up to 3 graphics, GPU computing adapters per system, 2nd CPU is needed
	PSU Maximum quantity of PCIe x16 adapters per system (by power) 650W/1x150W+2x75W (supports onboard SATA controller and up to 85W CPU) 850W/1x225W+2x75W, or 2x150W+1x75W
Disk drive controller	RAID 0, 1, 5, 10 with onboard SATA controller in chipset, SATA 6Gb/s. RAID 0, 1, 5, 10 with optional LSI RAID flex adapter, 12Gb/s SAS and SATA. RAID 0, 1, 5, 6, 10 with optional LSI 9364-8i PCIe adapter, 1GB memory, optional 1GB flash with super capacitor, 12Gb/s SAS and SATA
Drive Bays	Two external 5.25" bays, four internal 3.5" bays (see right)
Flex connector	One flex connectors (see right), supports one of the following: • Up to one LSI RAID flex adapter for SATA/SAS RAID • Up to one Multi-I/O flex adapters for two PCIe SSD • Up to one M.2 flex adapters for two M.2 SSD
Network interfaces	Integrated two Gigabit Ethernet ports, supports Wake-on-LAN. Optional discrete Ethernet is available
HD Audio	Realtek ALC662 codec
TPM	TCG 1.2-compliant
Power supply	One fixed 650 watts or 850 watts, autosensing, 92%, 80 PLUS Platinum qualified
Front ports	Four USB 3.0 (one Diagnostic, one Always On), one combo audio/microphone jack (3.5mm)
Rear ports	Four USB 2.0, four USB 3.0 (blue), one serial (9-pin), two ethernet (RJ-45), three analog audio ports (line-in, line-out, mic-in), two PS/2
IEEE 1394	Up to one 6-pin port on rear, one 6-pin port on front, 1394a-2000, 400Mbps
Thunderbolt	1 Thunderbolt via optional PCIe adapter. Uses slot 6.
Mechanical	• 36-liter: 175mm/6.89" W x 470mm/18.5" D x 440mm/17.32" H (with feet) • Tool-less parts: power supply, disk drive, fans, adapter retention • 52.25 lb (23.7kg) max configuration
Base warranty	3-year limited onsite service with 9x5/NBD

Drive Bays and Expansion slots



2 x 5.25", for half-height optical, or up to one optional flex module (Flex module supports one or more of the following options: 9.5mm optical/29-in-1 USB 3.0 reader/front IEEE 1394/front eSATA), or up to two optional front HDD bays



CPU 2
CPU 1

Expansion slots 1-6 (top-down)

Flex connector

HDD 1HDD 3
HDD 2HDD 4

Slot 1: PCIe 3.0 x16, Half length, full height, by CPU2
Slot 2: PCIe 3.0 x16, Full length, full height, by CPU1
Slot 3: PCIe 3.0 x8, Full length, full height, by CPU2
Slot 4: PCIe 3.0 x16, Full length, full height, by CPU1
Slot 5: PCI, Full length, full height, by PCH
Slot 6: PCIe 2.0 x4, Half length, full height, by PCH

Note:

- When LSI RAID flex adapter or 9364-8i adapter is installed, each HDD bay (HDD 1 - 4) can support 2 disk drives (1 x 3.5" drives + 2.5" SATA/SAS SSD, or 2 x 2.5" SATA/SAS SSD).
- More than 4 drives requires LSI RAID flex adapter or 9364-8i adapter.

Supporting NVIDIA graphics and GPU computing list

Adapter	Cores	Memory	Power	SLI	Connector***
NVS 310	48	1GB	19.5W		2xDP
NVS 315	48	1024MB	19.5W		2xDVI-I SL/2xDP
NVS 510	192	2048MB	33.4W		4xmini DP
Quadro 410	192	512MB	36.7W		DVI-I DL+DP
Quadro K600	192	1GB	41W		DVI-I DL+DP
Quadro K2000	384	2GB	51.1W		DVI-I DL+2xDP
Quadro K2000D	384	2GB	51.1W		DVI-I DL+DVI-D DL+mini DP
Quadro K4000	768	3GB	80W		DVI-I DL+2xDP
Quadro K5000	1536	4GB	122W		DVI-I DL+DVI-D DL+2xDP
Quadro K6000	2880	12GB	225W		DVI-I DL+DVI-D DL+2xDP
Quadro K420	192	2GB	41W		DVI-I DL+DP
Quadro K620	384	2GB	45W		DVI-I DL+DP
Quadro K2200	640	4GB	68W		DVI-I DL+2xDP
Quadro K4200	1344	4GB	108W		DVI-I DL+2xDP
Quadro K5200	2304	8GB	150W	SLI	DVI-I DL+DVI-D DL+2xDP
Quadro M4000	1664	8GB	120W		4xDP
Quadro M5000	2048	8GB	150W		DVI-I DL+4xDP
Quadro M6000	3072	12GB	250W		DVI-I DL+4xDP
Tesla K20	2496	5GB	225W		
GRID K2	3072	8GB	225W		

** DL = Dual link, SL = Single Link, DP = DisplayPort 1.2

Supporting storage list

(SAS drive needs LSI RAID flex adapter or 9364-8i adapter)

3.5" SATA (7.2K 6Gbs HDD)	500GB/1TB/2TB/3TB/4TB/1TB hybrid/2TB hybrid
2.5" SAS (15K 12Gbs HDD)	300GB/450GB/600GB
2.5" SAS SSD (12Gbs)	200GB/400GB/800GB
2.5" SATA SSD (6Gbs)	128GB/180GB/240GB/256GB/480GB/512GB/1TB (Optional OPAL)
M.2 SSD	256 GB/512GB (Optional NVMe)
PCIe SSD adapter	410GB/1.6TB

Environment specification and certifications

Temperature	
Operating:	50 °F to 95 °F (10 °C to 35 °C)
Storage:	-10 °C to 60 °C, no package -40 °C to 60 °C, with package
Altitude	
Operating:	-50~10000ft (-15.2~3048m)
Humidity	
Operating:	10%~80%, non-condensing
Storage:	10%~90%, non-condensing

RoHS-compliant/EPEAT Gold rating on all model, ENERGY STAR 6.1 qualified on selected models.

For the latest list of ISV certifications, please visit www.lenovo.com/support/ISV
For a list of all supported options, please visit https://download.lenovo.com/pccbbs/options_iso/ocm_april_2016.xlsx sheet

Model	Region	Processor	Graphics	Memory (Capacity/Type)	RAID Controller	Max Drives in 3.5" Bays	Storage	Optical	Media Reader	Power Supply	Add-on Ports	Keyboard / Mouse	Operating System	Warranty	Global	Ann Date (mm/yy)
30A9001CUS	US	1xE5-2609 v3 6C/1.9GHz/15MB/85W/DDR4-1600	Open	1x4GB RDIMM DDR4-2133 ECC	Onboard	4	1x1TB HDD 7.2K 3.5" SATA6Gbs	HH DVD±RW	9-in-1	650W 92%	None	USB / USB Optical	Windows 8.1 Pro 64-bit	3-year	No	10/14
30A9001DUS	US	1xE5-2620 v3 6C/2.4GHz/15MB/85W/DDR4-1866	Open	2x4GB RDIMM DDR4-2133 ECC	Onboard	4	1x180GB SSD 2.5" SATA6Gbs	HH DVD±RW	9-in-1	650W 92%	None	USB / USB Optical	Windows 8.1 Pro 64-bit	3-year	No	10/14
30A9001EUS	US	1xE5-2640 v3 8C/2.6GHz/20MB/90W/DDR4-1866	Open	2x4GB RDIMM DDR4-2133 ECC	Onboard	4	1x256GB SSD M.2 PCIe	HH DVD±RW	9-in-1	850W 92%	None	USB / USB Optical	Windows 8.1 Pro 64-bit	3-year	No	10/14
30A9002EUS	US	1xE5-2609 v3 6C/1.9GHz/15MB/85W/DDR4-1600	Open	1x8GB RDIMM DDR4-2133 ECC	Onboard	4	1x1TB Hybrid HDD 7.2K 3.5" SATA6Gbs	HH DVD±RW	9-in-1	850W 92%	None	USB / USB Optical	Windows 10 DG Windows 7 Pro 64	3-year	No	09/15
30A9002FUS	US	1xE5-2620 v3 6C/2.4GHz/15MB/85W/DDR4-1866	Open	1x8GB RDIMM DDR4-2133 ECC	Onboard	4	1x256GB SSD M.2 PCIe Opal	HH DVD±RW	9-in-1	850W 92%	None	USB / USB Optical	Windows 10 DG Windows 7 Pro 64	3-year	No	09/15
30A9002GUS	US	1xE5-2643 v3 6C/3.4GHz/20MB/135W/DDR4-2133	Open	1x8GB RDIMM DDR4-2133 ECC	Onboard	4	1x256GB SSD M.2 PCIe Opal	HH DVD±RW	9-in-1	850W 92%	None	USB / USB Optical	Windows 10 DG Windows 7 Pro 64	3-year	No	09/15
30A9002HUS	US	2xE5-2667 v3 8C/3.2GHz/20MB/135W/DDR4-2133	Open	2x8GB RDIMM DDR4-2133 ECC	Onboard	4	1x256GB SSD M.2 PCIe Opal	HH DVD±RW	9-in-1	850W 92%	None	USB / USB Optical	Windows 10 DG Windows 7 Pro 64	3-year	No	09/15
30A9002PUS	US	2xE5-2630 v3 8C/2.4GHz/20MB/85W/DDR4-1866	NVIDIA Quadro K2200 4GB	4x8GB RDIMM DDR4-2133 ECC	Onboard	4	1x512GB SSD 2.5" SATA6Gbs	HH DVD±RW	9-in-1	650W 92%	None	USB / USB Optical	Windows 10 DG Windows 7 Pro 64	3-year	No	02/16
30A9002UUS	US	1xE5-2609 v3 6C/1.9GHz/15MB/85W/DDR4-1600	Open	1x4GB RDIMM DDR4-2133 ECC	Onboard	4	1x1TB HDD 7.2K 3.5" SATA6Gbs	HH DVD±RW	9-in-1	650W 92%	None	USB / USB Optical	Windows 10 DG Windows 7 Pro 64	3-year	No	03/16
30A9002VUS	US	1xE5-2637 v3 4C/3.5GHz/15MB/135W/DDR4-2133	Open	2x8GB RDIMM DDR4-2133 ECC	Onboard	4	1x256GB SSD M.2 PCIe Opal	HH DVD±RW	9-in-1	850W 92%	None	USB / USB Optical	Windows 10 DG Windows 7 Pro 64	3-year	No	03/16
30A9002WUS	US	2xXeon E5-2650L v3 12C/1.8GHz/30MB/65W/DDR4-2133	Open	2x8GB RDIMM DDR4-2133 ECC	LSI Flex	8	1x1TB HDD 7.2K 3.5" SATA6Gbs	HH DVD±RW	9-in-1	850W 92%	None	USB / USB Optical	Windows 10 DG Windows 7 Pro 64	3-year	No	03/16
30A9002XUS	US	1xE5-2620 v3 6C/2.4GHz/15MB/85W/DDR4-1866	Open	1x8GB RDIMM DDR4-2133 ECC	Onboard	4	1x180GB SSD 2.5" SATA6Gbs Opal	HH DVD±RW	9-in-1	650W 92%	None	USB / USB Optical	Windows 10 DG Windows 7 Pro 64	3-year	No	03/16
30A9002YUS	US	1xE5-2620 v3 6C/2.4GHz/15MB/85W/DDR4-1866	NVIDIA Quadro K4200 4GB	1x8GB RDIMM DDR4-2133 ECC	Onboard	4	1x1TB HDD 7.2K 3.5" SATA6Gbs	HH DVD±RW	9-in-1	850W 92%	None	USB / USB Optical	Windows 10 DG Windows 7 Pro 64	3-year	No	03/16
30A90030US	US	1xE5-2630 v3 8C/2.4GHz/20MB/85W/DDR4-1866	NVIDIA Quadro K4200 4GB	1x8GB RDIMM DDR4-2133 ECC	Onboard	4	1x2TB HDD 7.2K 3.5" SATA6Gbs	HH DVD±RW	9-in-1	850W 92%	None	USB / USB Optical	Windows 10 DG Windows 7 Pro 64	3-year	No	03/16

Model	Region	Processor	Graphics	Memory (Capacity/Type)	RAID Controller	Max Drives in 3.5" Bays	Storage	Optical	Media Reader	Power Supply	Add-on Ports	Keyboard / Mouse	Operating System	Warranty	Global	Ann Date (mm/yy)
30A8000LUS	US	2xE5-2620 v3 6C/2.4GHz/15MB/85W/DDR4-1866	NVIDIA Quadro K2200 4GB	2x8GB RDIMM DDR4-2133 ECC	Onboard	4	2x500GB HDD 7.2K 3.5" SATA6Gbs	HH DVD±RW	None	850W 92%	None	USB / USB Optical	Windows 8.1 Pro 64-bit	3-year	No	10/14
30A8000MUS	US	2xE5-2623 v3 4C/3GHz/10MB/105W/DDR4-1866	NVIDIA Quadro K4200 4GB	2x8GB RDIMM DDR4-2133 ECC	Onboard	4	2x180GB SSD 2.5" SATA6Gbs	HH DVD±RW	None	850W 92%	None	USB / USB Optical	Windows 8.1 Pro 64-bit	3-year	No	10/14
30A8003AUS	US	1xE5-2609 v3 6C/1.9GHz/15MB/85W/DDR4-1600	Open	2x4GB RDIMM DDR4-2133 ECC	Onboard	4	1x1TB HDD 7.2K 3.5" SATA6Gbs	HH DVD±RW	9-in-1	650W 92%	None	USB / USB Optical	Windows 8.1 Pro 64-bit	3-year	No	10/14
30A8003BUS	US	1xE5-2620 v3 6C/2.4GHz/15MB/85W/DDR4-1866	NVIDIA Quadro K620 2GB	2x4GB RDIMM DDR4-2133 ECC	Onboard	4	1x1TB HDD 7.2K 3.5" SATA6Gbs	HH DVD±RW	9-in-1	650W 92%	None	USB / USB Optical	Windows 8.1 Pro 64-bit	3-year	No	10/14
30A8003CUS	US	1xE5-2630 v3 8C/2.4GHz/20MB/85W/DDR4-1866	NVIDIA Quadro K2200 4GB	2x4GB RDIMM DDR4-2133 ECC	Onboard	4	1x180GB SSD 2.5" SATA6Gbs	HH DVD±RW	9-in-1	650W 92%	None	USB / USB Optical	Windows 8.1 Pro 64-bit	3-year	No	10/14

ThinkStation P710 Platform Specifications

Components	Specification																																																																																																												
Chipset	Intel C612 Platform Controller Hub (PCH)																																																																																																												
System mgmt	Intel Active Management Technology 9																																																																																																												
Processor	Up to two 145W Intel Xeon E5-2600 v4 family processors. Each processor supports up to 22 cores up to 2.2GHz, 16 cores up to 2.6GHz, 14 cores up to 2.6GHz, 12 cores up to 2.2GHz, 10 cores up to 2.4GHz, 8 cores up to 3.2GHz, 6 cores up to 3.4GHz, 4 cores up to 3.5GHz. Or up to two Intel Xeon E5-2620 v3 or E5-2609 v3 processors (not available in EMEA)																																																																																																												
Coprocessor	None																																																																																																												
Memory DIMM slots	12 DIMM sockets (6 DIMMs per processor), 8-channel capable (4-channel per processor). RDIMM, ECC, DDR4-2400																																																																																																												
Memory capacity	384GB, 2nd CPU is needed																																																																																																												
Graphics, GPU computing	Three PCIe 3.0 x16 slots, two via CPU1, one via CPU2. Up to three graphics and GPU computing adapters, 2nd CPU is needed																																																																																																												
	PSU Maximum quantity of PCIe x16 adapters per system (by power) 650W 1x150W+2x75W with onboard SATA controller and up to two 120W CPU each 850W 1x300W+2x75W (up to two 120W CPU each), or 2x150W+1x75W																																																																																																												
Supporting Graphics and GPU computing	<table border="1"> <thead> <tr> <th>Adapter</th> <th>Cores</th> <th>Memory</th> <th>Power</th> <th>SLI</th> <th>Connector***</th> </tr> </thead> <tbody> <tr> <td>NVS 310</td> <td>48</td> <td>1GB</td> <td>19.5W</td> <td></td> <td>2xDP</td> </tr> <tr> <td>NVS 315</td> <td>48</td> <td>1GB</td> <td>19.5W</td> <td></td> <td>2xDVI-I SL/2xDP</td> </tr> <tr> <td>NVS 510</td> <td>192</td> <td>2GB</td> <td>35W</td> <td></td> <td>4xmini DP</td> </tr> <tr> <td>NVS 810</td> <td>1024</td> <td>4GB</td> <td>68W</td> <td></td> <td>8xmini DP</td> </tr> <tr> <td>Quadro K420</td> <td>192</td> <td>2GB</td> <td>41W</td> <td></td> <td>DVI-I DL+DP</td> </tr> <tr> <td>Quadro K620</td> <td>384</td> <td>2GB</td> <td>45W</td> <td></td> <td>DVI-I DL+DP</td> </tr> <tr> <td>Quadro K1200</td> <td>512</td> <td>4GB</td> <td>45W</td> <td></td> <td>4xmini DP</td> </tr> <tr> <td>Quadro K2200</td> <td>640</td> <td>4GB</td> <td>68W</td> <td></td> <td>DVI-I DL+2xDP</td> </tr> <tr> <td>Quadro K4200</td> <td>1344</td> <td>4GB</td> <td>108W</td> <td></td> <td>DVI-I DL+2xDP</td> </tr> <tr> <td>Quadro K5200</td> <td>2304</td> <td>8GB</td> <td>150W</td> <td>SLI</td> <td>DVI-I DL+DVI-D DL+2xDP</td> </tr> <tr> <td>Quadro M2000</td> <td>768</td> <td>4GB</td> <td>75W</td> <td></td> <td>4xDP</td> </tr> <tr> <td>Quadro M4000</td> <td>1664</td> <td>8GB</td> <td>120W</td> <td></td> <td>4xDP</td> </tr> <tr> <td>Quadro M5000</td> <td>2048</td> <td>8GB</td> <td>150W</td> <td>SLI</td> <td>DVI-I DL+4xDP</td> </tr> <tr> <td>Quadro M6000</td> <td>3072</td> <td>24GB</td> <td>250W</td> <td>SLI</td> <td>DVI-I DL+4xDP</td> </tr> <tr> <td>Quadro P5000</td> <td>2560</td> <td>16GB</td> <td>180W</td> <td></td> <td>DVI-D DL+4xDP</td> </tr> <tr> <td>Quadro P6000</td> <td>3840</td> <td>24GB</td> <td>250W</td> <td></td> <td>DVI-D DL+4xDP</td> </tr> <tr> <td>Tesla K40</td> <td>2880</td> <td>12GB</td> <td>235W</td> <td></td> <td></td> </tr> </tbody> </table>	Adapter	Cores	Memory	Power	SLI	Connector***	NVS 310	48	1GB	19.5W		2xDP	NVS 315	48	1GB	19.5W		2xDVI-I SL/2xDP	NVS 510	192	2GB	35W		4xmini DP	NVS 810	1024	4GB	68W		8xmini DP	Quadro K420	192	2GB	41W		DVI-I DL+DP	Quadro K620	384	2GB	45W		DVI-I DL+DP	Quadro K1200	512	4GB	45W		4xmini DP	Quadro K2200	640	4GB	68W		DVI-I DL+2xDP	Quadro K4200	1344	4GB	108W		DVI-I DL+2xDP	Quadro K5200	2304	8GB	150W	SLI	DVI-I DL+DVI-D DL+2xDP	Quadro M2000	768	4GB	75W		4xDP	Quadro M4000	1664	8GB	120W		4xDP	Quadro M5000	2048	8GB	150W	SLI	DVI-I DL+4xDP	Quadro M6000	3072	24GB	250W	SLI	DVI-I DL+4xDP	Quadro P5000	2560	16GB	180W		DVI-D DL+4xDP	Quadro P6000	3840	24GB	250W		DVI-D DL+4xDP	Tesla K40	2880	12GB	235W		
	Adapter	Cores	Memory	Power	SLI	Connector***																																																																																																							
	NVS 310	48	1GB	19.5W		2xDP																																																																																																							
	NVS 315	48	1GB	19.5W		2xDVI-I SL/2xDP																																																																																																							
	NVS 510	192	2GB	35W		4xmini DP																																																																																																							
	NVS 810	1024	4GB	68W		8xmini DP																																																																																																							
	Quadro K420	192	2GB	41W		DVI-I DL+DP																																																																																																							
	Quadro K620	384	2GB	45W		DVI-I DL+DP																																																																																																							
	Quadro K1200	512	4GB	45W		4xmini DP																																																																																																							
	Quadro K2200	640	4GB	68W		DVI-I DL+2xDP																																																																																																							
	Quadro K4200	1344	4GB	108W		DVI-I DL+2xDP																																																																																																							
	Quadro K5200	2304	8GB	150W	SLI	DVI-I DL+DVI-D DL+2xDP																																																																																																							
	Quadro M2000	768	4GB	75W		4xDP																																																																																																							
	Quadro M4000	1664	8GB	120W		4xDP																																																																																																							
	Quadro M5000	2048	8GB	150W	SLI	DVI-I DL+4xDP																																																																																																							
	Quadro M6000	3072	24GB	250W	SLI	DVI-I DL+4xDP																																																																																																							
	Quadro P5000	2560	16GB	180W		DVI-D DL+4xDP																																																																																																							
Quadro P6000	3840	24GB	250W		DVI-D DL+4xDP																																																																																																								
Tesla K40	2880	12GB	235W																																																																																																										
Disk drive controller	RAID 0, 1, 5, 10 with onboard SATA controller in chipset, SATA 6Gb/s. RAID 0, 1, 5, 10 with optional LSI RAID flex adapter, 12Gb/s SAS and SATA. RAID 0, 1, 5, 6, 10 with optional LSI 9364-8i PCIe adapter, 1GB memory, 12Gb/s SAS and SATA																																																																																																												
Drive Bays	Two external 5.25" flex bays, four 3.5" internal bays. Each 3.5" bay can support dual drives on selected models (see right)																																																																																																												
Flex bay	Two 5.25" flex bays for optical drives, Front Access Storage Enclosure drives, Flex Bay Storage Enclosure drives, or flex module. <ul style="list-style-type: none"> Up to two half-height optical drives or up to one 9.5mm optical drive, DVD-ROM, DVD±RW, or Blu-Ray burner Up to one Front Access Storage Enclosure for one 3.5" or 2.5" SATA drive. Up to two Flex Bay Storage Enclosure for two 3.5" or 2.5" SATA drives. 																																																																																																												
Supporting storage	3.5" SATA HDD, 7.2K 6Gbs	500GB/1TB/2TB/3TB/4TB/6TB/1TB hybrid/2TB hybrid																																																																																																											
	2.5" SAS HDD, 15K 12Gbs	300GB/600GB																																																																																																											
	2.5" SAS SSD, 12Gbs	200GB/400GB/800GB																																																																																																											
	2.5" SAS HDD, 10K 12Gbs	300GB																																																																																																											
	2.5" SATA SSD, 6Gbs	180GB/240GB/256GB/480GB/512GB/1TB, optional OPAL																																																																																																											
	PCIe SSD, 2.5"	400GB																																																																																																											
	PCIe SSD, M.2	256 GB/512GB/1TB																																																																																																											
PCIe SSD adapter	400GB (up to 4 per system, 2nd CPU is needed)																																																																																																												
Flex connector	One flex connectors (see right), supports one of the following: <ul style="list-style-type: none"> Up to one LSI RAID flex adapter for SATA/SAS RAID Up to one Multi-I/O flex adapters for two PCIe SSD Up to one M.2 flex adapters for two M.2 PCIe SSD 																																																																																																												
Network interfaces	Integrated two-port gigabit ethernet (Intel i218LM and i210AT), supports Wake-on-LAN. Optional discrete ethernet adapters are available																																																																																																												
HD Audio	Realtek ALC662 codec																																																																																																												

Components	Specification												
TPM	TCG 1.2-compliant												
Power supply	One fixed 650 watts or 850 watts, autosensing, 92%, 80 PLUS Platinum qualified												
Front ports	Four USB 3.0 (one Diagnostic, one Always On), one combo audio/microphone jack (3.5mm)												
Rear ports	Four USB 2.0, four USB 3.0 (blue), one serial (9-pin), two ethernet (RJ-45), three analog audio ports (line-in, line-out, mic-in), two PS/2												
Add-on ports	Supports the following optional ports: Two IEEE 1394 (one on rear and one on front flex module) via PCIe adapter, up to one adapter per system. Two rear USB 3.0 per PCIe adapter, up to three adapters per system. One rear Thunderbolt via PCIe adapter. One front eSATA (on flex module), or one rear eSATA via cable (also needs one PCIe slot), up to one eSATA port per system. One internal USB 3.0 port via cable, cannot be intermixed with 29-in-1 reader												
	Media reader	9-in-1 USB 2.0 card reader. Optional 29-in-1 USB 3.0 card reader on flex module											
Mechanical	<ul style="list-style-type: none"> 36-liter: 175mm/6.89" W x 485mm/19.1" D x 446mm/17.6" H (with feet) Tool-less parts: all except CPU fansink 52.25 lb (23.7kg) max configuration 												
	Environmental specification	<table border="1"> <tbody> <tr> <td>Temperature - operating</td> <td>50 °F to 95 °F (10 °C to 35 °C)</td> </tr> <tr> <td>Temperature - non operating (no package)</td> <td>14 °F to 140 °F (-10 °C to 60 °C)</td> </tr> <tr> <td>Temperature - non operating (with package)</td> <td>-40 °F to 140 °F (-40 °C to 60 °C)</td> </tr> <tr> <td>Altitude - operating</td> <td>(Unpressurized): 0-10000ft (0-3048m)</td> </tr> <tr> <td>Humidity - operating</td> <td>10%-80%, non-condensing</td> </tr> <tr> <td>Humidity - storage (with package)</td> <td>10%-90%, non-condensing</td> </tr> </tbody> </table> <p>RoHS-compliant, GREENGUARD on all models. EPEAT Gold rating, ENERGY STAR 6.1 qualified on selected models.</p>	Temperature - operating	50 °F to 95 °F (10 °C to 35 °C)	Temperature - non operating (no package)	14 °F to 140 °F (-10 °C to 60 °C)	Temperature - non operating (with package)	-40 °F to 140 °F (-40 °C to 60 °C)	Altitude - operating	(Unpressurized): 0-10000ft (0-3048m)	Humidity - operating	10%-80%, non-condensing	Humidity - storage (with package)
Temperature - operating	50 °F to 95 °F (10 °C to 35 °C)												
Temperature - non operating (no package)	14 °F to 140 °F (-10 °C to 60 °C)												
Temperature - non operating (with package)	-40 °F to 140 °F (-40 °C to 60 °C)												
Altitude - operating	(Unpressurized): 0-10000ft (0-3048m)												
Humidity - operating	10%-80%, non-condensing												
Humidity - storage (with package)	10%-90%, non-condensing												
Base warranty	3-year limited onsite service with 9x5/NBD												

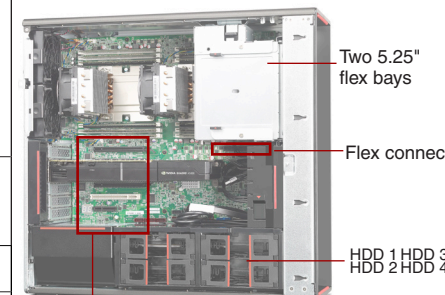

Expansion slots
Slot 1: PCIe 3.0 x16, half length, full height, CPU2 needed (full length, full height if no flex adapter)
Slot 2: PCIe 3.0 x16, full length, full height
Slot 3: PCIe 3.0 x8, full length, full height, CPU2 needed
Slot 4: PCIe 3.0 x16, full length, full height
Slot 5: PCI, full length, full height
Slot 6: PCIe 2.0 x4, half length, full height
Also supports one flex connector

Expansion slots 1-6 (top-down)

Drive Bays
HDD 1-4: Standard 3.5" HDD bay, up to four 3.5" or 2.5" disk drives. On selected models, each 3.5" bay can supports 2.5" (9mm or less) drive plus 3.5" drive, or two 2.5" (15mm or less) drives.
Flex bay: Two 5.25" flex bays, for HH optical drives. Or up to one optional flex module (Flex module supports one or more of the following options: 9.5mm optical/29-in-1 USB 3.0 reader/front IEEE 1394/front eSATA). Or up to two HDD bays for two drives, 3.5" or 2.5" each, SATA only.

For the list of ISV certifications, please visit www.thinkworkstations.com/isv-certifications/
For a list of all supported options, please visit https://download.lenovo.com/pccbbs/options_iso/ocm_december_2016.xlsx sheet

Model	Region	Processor	Graphics	Memory (Capacity/Type)	RAID Controller	Max Drives in 3.5" Bays	Storage (Capacity/Type/Interface)	Optical	Media Reader	Power Supply	Add-on Ports	Discrete ethernet	Keyboard / Mouse	Operating System	Warranty	Ann Date (mm/yy)
30B7000RUS	US	2xXeon E5-2623 v4 4C/2.6GHz/10MB/85W/DDR4-2133	Open	2x8GB RDIMM DDR4-2400 ECC	Onboard	4	1x256GB SSD 2.5" SATA6Gbs Opal	HH DVD±RW	9-in-1	650W 92%	None	None	USB / USB Optical	Windows 10 Pro 64	3-year	04/16
30B7000SUS	US	1xXeon E5-2623 v4 4C/2.6GHz/10MB/85W/DDR4-2133	Open	2x8GB RDIMM DDR4-2400 ECC	Onboard	4	1x256GB SSD 2.5" SATA6Gbs Opal	HH DVD±RW	9-in-1	650W 92%	None	None	USB / USB Optical	Windows 10 Pro 64	3-year	04/16
30B7000TUS	US	2xXeon E5-2620 v4 8C/2.1GHz/20MB/85W/DDR4-2133	Open	2x8GB RDIMM DDR4-2400 ECC	Onboard	4	1x1TB HDD 7.2K 3.5" SATA6Gbs	HH DVD±RW	9-in-1	850W 92%	None	None	USB / USB Optical	Windows 10 Pro 64	3-year	04/16
30B7000UUS	US	2xXeon E5-2637 v4 4C/3.5GHz/15MB/135W/DDR4-2400	Open	2x8GB RDIMM DDR4-2400 ECC	Onboard	4	1x256GB SSD 2.5" SATA6Gbs Opal	HH DVD±RW	9-in-1	850W 92%	None	None	USB / USB Optical	Windows 10 Pro 64	3-year	04/16
30B7000VUS	US	1xXeon E5-2637 v4 4C/3.5GHz/15MB/135W/DDR4-2400	Open	2x8GB RDIMM DDR4-2400 ECC	Onboard	4	1x256GB SSD 2.5" SATA6Gbs Opal	HH DVD±RW	9-in-1	850W 92%	None	None	USB / USB Optical	Windows 10 Pro 64	3-year	04/16
30B7000WUS	US	2xXeon E5-2643 v4 6C/3.4GHz/20MB/135W/DDR4-2400	NVIDIA Quadro M4000 8GB	4x8GB RDIMM DDR4-2400 ECC	Onboard	4	1x1TB SSD 2.5" SATA6Gbs	HH DVD±RW	9-in-1	850W 92%	None	None	USB / USB Optical	Windows 10 Pro 64	3-year	04/16
30B7000XUS	US	2xXeon E5-2623 v4 4C/2.6GHz/10MB/85W/DDR4-2133	NVIDIA Quadro M2000 4GB	2x8GB RDIMM DDR4-2400 ECC	Onboard	4	1x256GB SSD 2.5" SATA6Gbs Opal	HH DVD±RW	9-in-1	650W 92%	None	None	USB / USB Optical	Windows 10 Pro 64	3-year	04/16
30B7000YUS	US	1xXeon E5-2620 v4 8C/2.1GHz/20MB/85W/DDR4-2133	Open	2x8GB RDIMM DDR4-2400 ECC	Onboard	4	1x1TB HDD 7.2K 3.5" SATA6Gbs	HH DVD±RW	9-in-1	850W 92%	None	None	USB / USB Optical	Windows 10 Pro 64	3-year	04/16
30B7001MUS	US	1xXeon E5-2650 v4 12C/2.2GHz/30MB/105W/DDR4-2400	NVIDIA Quadro M4000 8GB	2x8GB RDIMM DDR4-2400 ECC	Onboard	4	1x1TB HDD 7.2K 3.5" SATA6Gbs+1x256GB SSD M.2 PCIe	HH DVD±RW	9-in-1	850W 92%	None	None	USB / USB Optical	Windows 10 Pro 64	3-year	07/16
30B7001NUS	US	2xXeon E5-2620 v4 8C/2.1GHz/20MB/85W/DDR4-2133	Open	2x8GB RDIMM DDR4-2400 ECC	Onboard	4	1x1TB HDD 7.2K 3.5" SATA6Gbs+1x256GB SSD M.2 PCIe	HH DVD±RW	9-in-1	850W 92%	None	None	USB / USB Optical	Windows 10 Pro 64	3-year	07/16
30B7001PUS	US	2xXeon E5-2620 v4 8C/2.1GHz/20MB/85W/DDR4-2133	NVIDIA Quadro M2000 4GB	2x8GB RDIMM DDR4-2400 ECC	Onboard	4	1x1TB HDD 7.2K 3.5" SATA6Gbs+1x256GB SSD M.2 PCIe	HH DVD±RW	9-in-1	850W 92%	None	None	USB / USB Optical	Windows 10 Pro 64	3-year	07/16
30B70023US	US	2xXeon E5-2620 v4 8C/2.1GHz/20MB/85W/DDR4-2133	Open	2x8GB RDIMM DDR4-2400 ECC	Onboard	4	1x1TB HDD 7.2K 3.5" SATA6Gbs+1x256GB SSD M.2 PCIe	HH DVD±RW	9-in-1	850W 92%	None	None	USB / USB Optical	Windows 10 DG Windows 7 Pro 64	3-year	09/16
30B70024US	US	1xXeon E5-2650 v4 12C/2.2GHz/30MB/105W/DDR4-2400	NVIDIA Quadro M4000 8GB	2x8GB RDIMM DDR4-2400 ECC	Onboard	4	1x1TB HDD 7.2K 3.5" SATA6Gbs+1x256GB SSD M.2 PCIe	HH DVD±RW	9-in-1	850W 92%	None	None	USB / USB Optical	Windows 10 DG Windows 7 Pro 64	3-year	09/16
30B70025US	US	2xXeon E5-2620 v4 8C/2.1GHz/20MB/85W/DDR4-2133	NVIDIA Quadro M2000 4GB	2x8GB RDIMM DDR4-2400 ECC	Onboard	4	1x1TB HDD 7.2K 3.5" SATA6Gbs+1x256GB SSD M.2 PCIe	HH DVD±RW	9-in-1	850W 92%	None	None	USB / USB Optical	Windows 10 DG Windows 7 Pro 64	3-year	09/16
30B70029US	US	2xXeon E5-2623 v4 4C/2.6GHz/10MB/85W/DDR4-2133	NVIDIA Quadro P5000 16GB	2x8GB RDIMM DDR4-2400 ECC	Onboard	4	1x1TB SSD M.2 PCIe NVMe Opal	HH DVD±RW	9-in-1	850W 92%	1xeSATA Rear	None	USB / USB Optical	Windows 10 DG Windows 7 Pro 64	3-year	12/16

Model	Region	Processor	Graphics	Memory (Capacity/Type)	RAID Controller	Max Drives in 3.5" Bays	Storage (Capacity/Type/Interface)	Optical	Media Reader	Power Supply	Add-on Ports	Discrete ethernet	Keyboard / Mouse	Operating System	Warranty	Ann Date (mm/yy)
30B7002AUS	US	1xXeon E5-2623 v4 4C/2.6GHz/10MB/85W/DDR4-2133	NVIDIA Quadro M2000 4GB	2x8GB RDIMM DDR4-2400 ECC	Onboard	4	1x512GB SSD 2.5" SATA6Gbs	HH DVD±RW	9-in-1	850W 92%	None	None	USB / USB Optical	Windows 10 DG Windows 7 Pro 64	3-year	12/16
30B7002BUS	US	1xXeon E5-2623 v4 4C/2.6GHz/10MB/85W/DDR4-2133	NVIDIA Quadro P5000 16GB	2x8GB RDIMM DDR4-2400 ECC	Onboard	4	1x1TB SSD M.2 PCIe NVMe Opal	HH DVD±RW	9-in-1	850W 92%	1xeSATA Rear	None	USB / USB Optical	Windows 10 DG Windows 7 Pro 64	3-year	12/16
30B7002CUS	US	1xXeon E5-2623 v4 4C/2.6GHz/10MB/85W/DDR4-2133	NVIDIA Quadro M2000 4GB	2x8GB RDIMM DDR4-2400 ECC	Onboard	4	1x256GB SSD 2.5" SATA6Gbs Opal	HH DVD±RW	9-in-1	650W 92%	None	None	USB / USB Optical	Windows 10 DG Windows 7 Pro 64	3-year	12/16
30B7002DUS	US	2xXeon E5-2637 v4 4C/3.5GHz/15MB/135W/DDR4-2400	NVIDIA Quadro P5000 16GB	2x16GB RDIMM DDR4-2400 ECC	Onboard	4	1x1TB SSD M.2 PCIe NVMe Opal	HH DVD±RW	9-in-1	850W 92%	1xeSATA Rear	None	USB / USB Optical	Windows 10 DG Windows 7 Pro 64	3-year	12/16
30B7002EUS	US	1xXeon E5-2623 v4 4C/2.6GHz/10MB/85W/DDR4-2133	NVIDIA Quadro M2000 4GB	2x8GB RDIMM DDR4-2400 ECC	Onboard	4	1x256GB SSD 2.5" SATA6Gbs Opal	HH DVD±RW	9-in-1	850W 92%	None	None	USB / USB Optical	Windows 10 DG Windows 7 Pro 64	3-year	12/16
30B7002FUS	US	2xXeon E5-2643 v4 6C/3.4GHz/20MB/135W/DDR4-2400	NVIDIA Quadro M4000 8GB	4x8GB RDIMM DDR4-2400 ECC	Onboard	4	1x1TB HDD 7.2K 3.5" SATA6Gbs	HH DVD±RW	9-in-1	850W 92%	None	None	USB / USB Optical	Windows 10 DG Windows 7 Pro 64	3-year	12/16
30B7002GUS	US	1xXeon E5-2623 v4 4C/2.6GHz/10MB/85W/DDR4-2133	Open	2x8GB RDIMM DDR4-2400 ECC	Onboard	4	1x1TB SSD M.2 PCIe NVMe Opal	HH DVD±RW	9-in-1	850W 92%	1xeSATA Rear	None	USB / USB Optical	Windows 10 DG Windows 7 Pro 64	3-year	12/16

ThinkStation P910 Platform Specifications

Components	Specification					
Chipset	Intel C612 Platform Controller Hub (PCH)					
System mgmt	Intel Active Management Technology 9					
Processor	Up to two 160W Intel Xeon E5-2600 v4 family processors. Each processor supports up to 22 cores up to 2.2GHz, 16 cores up to 2.6GHz, 14 cores up to 2.6GHz, 12 cores up to 3GHz, 10 cores up to 2.4GHz, 8 cores up to 3.2GHz, 6 cores up to 3.4GHz, 4 cores up to 3.5GHz. Or up to two Intel Xeon E5-2620 v3 or E5-2609 v3 processors (not available in EMEA)					
Coprocessor	Optional. Up to one Intel Xeon Phi Coprocessor 3120A, PCIe 2.0 x16 adapter, 57 cores, 1.1GHz, 28.5MB L2 cache, 6GB memory, 300W					
Memory DIMM slots	16 DIMM sockets (8 DIMMs per processor), 8-channel capable (4-channel per processor). RDIMM or LRDIMM (cannot be intermixed), ECC, DDR4, 2400MHz					
Memory capacity	896GB (LRDIMM, 14x64GB)/512GB (RDIMM, 16x32GB), 2nd CPU is needed					
Graphics and GPU computing	Four PCIe 3.0 x16 slots for graphics and GPU computing cards, two slots per processor					
	Installed CPU	Maximum quantity of PCIe x16 adapters per system (by power)				
	1	1x300W+1x75W or 2x150W				
2	2x300W+2x75W, or 1x300W+2x150W+1x75W, or 4x150W					
Supporting Graphics and GPU computing	Adapter	Cores	Memory	Power	SLI	Connector***
	NVS 310	48	1GB	19.5W		2xDP
	NVS 315	48	1GB	19.5W		2xDVI-I SL/2xDP
	NVS 510	192	2GB	35W		4xmini DP
	NVS 810	1024	4GB	68W		8xmini DP
	Quadro K420	192	2GB	41W		DVI-I DL+DP
	Quadro K620	384	2GB	45W		DVI-I DL+DP
	Quadro K1200	512	4GB	45W		4xmini DP
	Quadro K2200	640	4GB	68W		DVI-I DL+2xDP
	Quadro K4200	1344	4GB	108W		DVI-I DL+2xDP
	Quadro K5200	2304	8GB	150W	SLI	DVI-I DL+DVI-D DL+2xDP
	Quadro M2000	768	4GB	75W		4xDP
	Quadro M4000	1664	8GB	120W		4xDP
	Quadro M5000	2048	8GB	150W	SLI	DVI-I DL+4xDP
	Quadro M6000	3072	24GB	250W	SLI	DVI-I DL+4xDP
	Quadro P5000	2560	16GB	180W		DVI-D DL+4xDP
Quadro P6000	3840	24GB	250W		DVI-D DL+4xDP	
Tesla K40	2880	12GB	235W			
Disk drive controller	RAID 0, 1, 5, 10 with onboard SATA controller in chipset, 6Gb/s SATA. RAID 0, 1, 5, 10 with optional LSI RAID flex adapter, 12Gb/s SAS and SATA. RAID 0, 1, 5, 6, 10 with optional LSI 9364-8i PCIe adapter, 1GB memory, 12Gb/s SAS and SATA					
Drive Bays	Three external 5.25" bays, four internal 3.5" dual drives bays (see right)					
Flex bay	Three 5.25" flex bays for optical drives, Front Access Storage Enclosure drives, Flex Bay Storage Enclosure drives, or flex module. • Up to three half-height optical drives or up to one 9.5mm optical drive, DVD-ROM, DVD±RW, or Blu-Ray burner • Up to one Front Access Storage Enclosure for one 3.5" or 2.5" SATA drive. • Up to two Flex Bay Storage Enclosure for two 3.5" or 2.5" SATA drives.					
Supporting storage	3.5" SATA HDD, 7.2K 6Gbs	500GB/1TB/2TB/3TB/4TB/6TB/1TB hybrid/2TB hybrid				
	2.5" SAS HDD, 15K 12Gbs	300GB/600GB				
	2.5" SAS HDD, 10K 12Gbs	300GB				
	2.5" SAS SSD, 12Gbs	200GB/400GB/800GB				
	2.5" SATA SSD, 6Gbs	180GB/240GB/256GB/480GB/512GB/1TB, optional OPAL				
	PCIe SSD, 2.5"	400GB				
	PCIe SSD, M.2	256 GB/512GB/1TB				
	PCIe SSD adapter	400GB (up to 4 per system, 2nd CPU is needed)				
Flex connector	Two flex connectors (see right), one per processor. Supports one of the following: • Up to one LSI RAID flex adapter for SATA/SAS RAID. • Up to two Multi-I/O adapters for four PCIe SSD (two PCIe SSD per adapter). • Up to two M.2 flex adapters for four M.2 PCIe SSD (two M.2 PCIe SSD per adapter)					
Network interfaces	Integrated two-port gigabit ethernet (Intel i218LM and i210AT), Supports Wake-on-LAN. Optional discrete ethernet adapters are available					
HD Audio	Realtek ALC662 codec					

Components	Specification
TPM	TCG 1.2-compliant
Power supply	One fixed 1300 watts, autosensing, 92% PSU, 80 PLUS Platinum qualified <i>Note: PSU will automatically operate in 1120W (restricted mode) if the system line input is 100-110V. For other supported system line input voltages, the PSU will operate at the full 1300W.</i>
Front ports	Four USB 3.0 (one Diagnostic, one Always On), one combo audio/microphone jack (3.5mm)
Rear ports	Four USB 2.0, four USB 3.0 (blue), one serial (9-pin), two ethernet (RJ-45), three analog audio ports (line-in, line-out, mic-in), two PS/2
Add-on ports	Supports the following optional ports: Two IEEE 1394 (one on rear and one on front flex module) via PCIe adapter, up to one adapter per system. Two rear USB 3.0 per USB add-on PCIe adapter, up to 3 adapters per system. One rear Thunderbolt via PCIe adapter. One front eSATA (on flex module), or one rear eSATA via cable (also needs one PCIe slot), up to one eSATA port per system. One internal USB 3.0 port via cable, cannot be intermixed with 29-in-1 reader
Media reader	9-in-1 USB 2.0 card reader. Optional 29-in-1 USB 3.0 card reader on flex module
Mechanical	• 55-liter: 200mm/7.87" W x 620mm/24.4" D x 446mm/17.56" H (with feet) • Tool-less parts: all except CPU fansink • 71.3 lb (32.3kg) max configuration
	Environmental specification
Base warranty	RoHS-compliant, GREENGUARD on all models. EPEAT Gold rating, ENERGY STAR 6.1 qualified on selected models. 3-year limited onsite service with 9x5/NBD

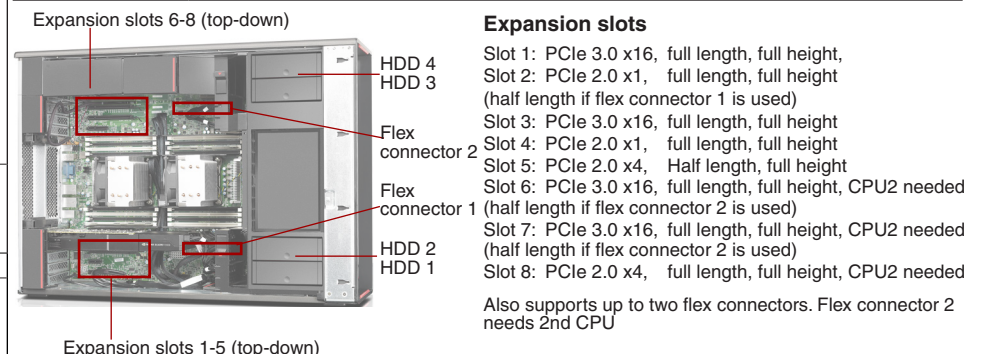

Drive bays
HDD 1-4: Standard 3.5" HDD bay, up to four 3.5" or 2.5" disk drives. Each 3.5" bay supports 2.5" (9mm or less) drive plus 3.5" drive, or two 2.5" (15mm or less) drives. More than 4 drives requires LSI RAID flex adapter or 9364-8i adapter,

Flex bay: Three 5.25" flex bays, for HH optical drives.
Or up to one optional flex module (Flex module supports one or more of the following options: 9.5mm optical/29-in-1 USB 3.0 reader/front IEEE 1394/front eSATA).
Or up to two HDD bays for two drives, 3.5" or 2.5" each, SATA only.

For the list of ISV certifications, please visit www.thinkworkstations.com/isv-certifications/
For a list of all supported options, please visit https://download.lenovo.com/pccbbs/options_iso/ocm_december_2016.xlsx sheet

ThinkStation P910 - TopSeller - 30B9

Product Specifications Reference (PSREF)

Model	Region	Processor	Graphics	Memory (Capacity/Type)	RAID Controller	Max Drives in 3.5" Bays	Storage (Capacity/Type/Interface)	Optical	Media Reader	Power Supply	Add-on Ports	Discrete Ethernet	Keyboard / Mouse	Operating System	Warranty	Ann Date (mm/yy)
30B9000EUS	US	1xXeon E5-2643 v4 6C/3.4GHz/20MB/135W/DDR4-2400	Open	2x8GB RDIMM DDR4-2400 ECC	Onboard	4	1x512GB SSD 2.5" SATA6Gbs	HH DVD±RW	9-in-1	1300W 92%	None	None	USB / None	Windows 10 Pro 64	3-year	04/16
30B9000FUS	US	2xXeon E5-2650 v4 12C/2.2GHz/30MB/105W/DDR4-2400	NVIDIA Quadro M5000 8GB	4x8GB RDIMM DDR4-2400 ECC	Onboard	4	1x1TB SSD 2.5" SATA6Gbs	HH DVD±RW	9-in-1	1300W 92%	None	None	USB / None	Windows 10 Pro 64	3-year	04/16
30B9000GUS	US	2xXeon E5-2643 v4 6C/3.4GHz/20MB/135W/DDR4-2400	Open	4x8GB RDIMM DDR4-2400 ECC	Onboard	4	1x1TB SSD 2.5" SATA6Gbs	HH DVD±RW	9-in-1	1300W 92%	None	None	USB / None	Windows 10 Pro 64	3-year	04/16
30B9000HUS	US	1xXeon E5-2623 v4 4C/2.6GHz/10MB/85W/DDR4-2133	Open	2x8GB RDIMM DDR4-2400 ECC	Onboard	4	1x512GB SSD 2.5" SATA6Gbs	HH DVD±RW	9-in-1	1300W 92%	None	None	USB / None	Windows 10 Pro 64	3-year	04/16
30B9001NUS	US	2xXeon E5-2650 v4 12C/2.2GHz/30MB/105W/DDR4-2400	NVIDIA Quadro M4000 8GB	4x8GB RDIMM DDR4-2400 ECC	Onboard	4	1x1TB HDD 7.2K 3.5" SATA6Gbs+1x512GB SSD M.2 PCIe	HH DVD±RW	9-in-1	1300W 92%	None	None	USB / USB Optical	Windows 10 Pro 64	3-year	07/16
30B9001PUS	US	2xXeon E5-2650 v4 12C/2.2GHz/30MB/105W/DDR4-2400	Open	4x8GB RDIMM DDR4-2400 ECC	Onboard	4	1x1TB HDD 7.2K 3.5" SATA6Gbs+1x512GB SSD M.2 PCIe	HH DVD±RW	9-in-1	1300W 92%	None	None	USB / USB Optical	Windows 10 Pro 64	3-year	07/16
30B9001UUS	US	2xXeon E5-2650 v4 12C/2.2GHz/30MB/105W/DDR4-2400	NVIDIA Quadro M4000 8GB	4x8GB RDIMM DDR4-2400 ECC	Onboard	4	1x1TB HDD 7.2K 3.5" SATA6Gbs+1x512GB SSD M.2 PCIe	HH DVD±RW	9-in-1	1300W 92%	None	None	USB / USB Optical	Windows 10 DG Windows 7 Pro 64	3-year	09/16
30B9001VUS	US	2xXeon E5-2650 v4 12C/2.2GHz/30MB/105W/DDR4-2400	Open	4x8GB RDIMM DDR4-2400 ECC	Onboard	4	1x1TB HDD 7.2K 3.5" SATA6Gbs+1x512GB SSD M.2 PCIe	HH DVD±RW	9-in-1	1300W 92%	None	None	USB / USB Optical	Windows 10 DG Windows 7 Pro 64	3-year	09/16
30B9001WUS	US	1xXeon E5-2643 v4 6C/3.4GHz/20MB/135W/DDR4-2400	Open	2x8GB RDIMM DDR4-2400 ECC	Onboard	4	1x512GB SSD 2.5" SATA6Gbs	HH DVD±RW	9-in-1	1300W 92%	None	None	USB / None	Windows 10 DG Windows 7 Pro 64	3-year	09/16
30B9001XUS	US	2xXeon E5-2650 v4 12C/2.2GHz/30MB/105W/DDR4-2400	NVIDIA Quadro M5000 8GB	4x8GB RDIMM DDR4-2400 ECC	Onboard	4	1x1TB SSD 2.5" SATA6Gbs	HH DVD±RW	9-in-1	1300W 92%	None	None	USB / None	Windows 10 DG Windows 7 Pro 64	3-year	09/16
30B9001YUS	US	2xXeon E5-2643 v4 6C/3.4GHz/20MB/135W/DDR4-2400	Open	4x8GB RDIMM DDR4-2400 ECC	Onboard	4	1x1TB SSD 2.5" SATA6Gbs	HH DVD±RW	9-in-1	1300W 92%	None	None	USB / None	Windows 10 DG Windows 7 Pro 64	3-year	09/16
30B90020US	US	1xXeon E5-2623 v4 4C/2.6GHz/10MB/85W/DDR4-2133	Open	2x8GB RDIMM DDR4-2400 ECC	Onboard	4	1x512GB SSD 2.5" SATA6Gbs	HH DVD±RW	9-in-1	1300W 92%	None	None	USB / None	Windows 10 DG Windows 7 Pro 64	3-year	09/16
30B9002DUS	US	2xXeon E5-2620 v4 8C/2.1GHz/20MB/85W/DDR4-2133	Open	2x16GB RDIMM DDR4-2400 ECC	Onboard	4	1x1TB SSD M.2 PCIe NVMe Opal	HH DVD±RW	9-in-1	1300W 92%	None	None	USB / USB Optical	Windows 10 DG Windows 7 Pro 64	3-year	12/16
30B9002EUS	US	2xXeon E5-2620 v4 8C/2.1GHz/20MB/85W/DDR4-2133	NVIDIA Quadro P5000 16GB	2x16GB RDIMM DDR4-2400 ECC	Onboard	4	1x1TB SSD M.2 PCIe NVMe Opal	HH DVD±RW	9-in-1	1300W 92%	None	None	USB / USB Optical	Windows 10 DG Windows 7 Pro 64	3-year	12/16
30B9002FUS	US	2xXeon E5-2620 v4 8C/2.1GHz/20MB/85W/DDR4-2133	NVIDIA Quadro P6000 24GB	2x16GB RDIMM DDR4-2400 ECC	Onboard	4	1x1TB SSD M.2 PCIe NVMe Opal	HH DVD±RW	9-in-1	1300W 92%	None	None	USB / USB Optical	Windows 10 DG Windows 7 Pro 64	3-year	12/16



Availability: All offers subject to availability. Lenovo reserves the right to alter product offerings and specifications at any time, without notice. Lenovo is not responsible for photographic or typographic errors.

Warranty: For a copy of applicable product warranties, write to: Warranty Support Dept., EMEA Services, Lenovo, Eisteinova 21, 851 01 Bratislava, Slovakia. Lenovo makes no representation or warranty regarding third party products or services.

¹ **Limited warranty:** Support unrelated to a warranty issue may be subject to additional charges.

² **Hard drive:** GB = billion bytes, TB = trillion bytes. Accessible capacity is less.

³ **Systems with limited onsite service** are designed to be repaired during the applicable warranty period primarily with customer-replaceable parts provided by Lenovo. Lenovo will only send a technician onsite to perform a repair if (a) remote telephone diagnosis and/or customer part replacement are unable to resolve the problem, or (b) the part is one of the few designated by Lenovo for onsite replacement. For a list of onsite replaceable parts, contact Lenovo. Support unrelated to a warranty issue may be subject to additional charges. Support phone list available at www-307.ibm.com/pc/support/site.wss/document.do?Indocid=MIGR-70552

⁴ **SATA/SAS:** The system configuration supports the installation of SATA, SAS, or mixing of SATA and SAS. But mixing of SATA and SAS disks into one RAID array will not be supported.

⁵ **Included software** may differ from its retail version (if available), and may not include user manuals or all program functionality. License agreements may apply.

⁶ **Multi-Burner Plus** is a DVD±RW device that reads and writes to DVD-RAM, DVD-R, DVD-RW, DVD+R, and DVD+RW. It also reads and writes to CD-R and CD-RW media. Super Multi-Burner DL also writes to DVD+R double layer media.

⁷ **Lenovo Services:** These services are available for machines normally used for business, professional, or trade purposes, rather than personal, family, or household purposes. Not all machine types and models are covered. Service period begins with the equipment date of purchase. Service must be purchased during the original limited product warranty period. Service levels are response time objectives and are not guarantees. If the machine problem turns out to be a Customer Replaceable Unit (CRU), a part will be express shipped to you for quick replacement. See Lenovo Warranty Services terms and conditions for complete details and restrictions.

⁸ **RAID:** Supported RAID levels for a system will vary from the stated capabilities of the RAID controller due to dependencies on the number and capacity of physical disks in the system and on customer requirements for performance, fault tolerance, or data redundancy.

RAID levels and requirements:

- **RAID 0 (striping)** provides increased performance by writing data across multiple drives.
- **RAID 1 (mirroring)** provides fault tolerance by writing the data on two drives.
- **RAID 5 (striping with parity)** uses distributed parity data to provide fault tolerance more efficiently than RAID 1. Requires three or more drives.
- **RAID 10 (or RAID 1+0)** combines RAID 1 and RAID 0 to create a stripe of mirrors that is fault tolerant while offering increased performance. Requires four drives.

⁹ **International Warranty Service** is available in any country in which this product is sold and serviced. Service delivery methods and parts availability vary by country, may be different from that in the country of purchase, and are subject to change without notice. Fees and restrictions may apply in some countries.

¹⁴ **Response times may vary.** May exclude some holidays. Telephone support may be subject to additional charges.

²⁰ **Operating System:** Level of support varies by operating system. Operating systems not preloaded on the system may not provide full feature functionality. Refer to lenovo.com/pc/support and enter your machine type and model number for more information.

This publication was developed for products and services offered in the United States. Lenovo may not offer the products, services or features discussed in this document in other countries. Lenovo may withdraw an offering at any time. Information is subject to change without notice. Consult your local representative for information on offerings available in your area.

Lenovo reserves the right to change specifications and other product information at any time without prior notice. Lenovo is not responsible for photographic or typographical errors. LENOVO PROVIDES THIS PUBLICATION "AS IS" WITHOUT WARRANTY OF ANY KIND, EITHER EXPRESS OR IMPLIED, INCLUDING THE IMPLIED WARRANTIES OF MERCHANTABILITY OR FITNESS FOR A PARTICULAR PURPOSE. Some jurisdictions do not allow disclaimer of express or implied warranties in certain transactions; therefore this disclaimer may not apply to you.

Trademarks: Lenovo, the Lenovo logo, New World, New Thinking., Access Connections, Rescue and Recovery, ThinkCentre, ThinkPad, ThinkServer, ThinkStation, ThinkVantage, and ThinkVision are trademarks of Lenovo. Microsoft, Windows, and Vista are registered trademarks of Microsoft Corporation. Intel, the Intel logo, Intel Inside logo, Intel Core and Core Inside are trademarks of Intel Corporation in the US and other countries. Other company, product, or service names may be trademarks or service marks of others.

Visit www.lenovo.com/safecomputing periodically for the latest information on safe and effective computing.

Visit www.lenovo.com/thinkstation/europe for the latest version of Product Specifications Reference.

© Lenovo
All rights reserved.

Lenovo
1009 Think Place
Morrisville, NC 27560
U.S.A.

Lenovo™ **ThinkServer**

PSREF



Product Specifications Reference

Version 502, February 2017

U.S.

Visit <http://psref.lenovo.com> for the latest version

Contents

Cover	1	ThinkServer RS140 - TopSeller - 70F9 - 1 of 2	36
Contents	2	ThinkServer RS140 - TopSeller - 70F9 - 2 of 2	37
Summary Of Change	3	ThinkServer RS140 - 70F2	38
Racks	5	ThinkServer RS140 - 70F8	39
ThinkServer RD350	5	ThinkServer RS160	40
ThinkServer RD350 Platform Specifications	6	ThinkServer RS160 Platform Specifications	41
ThinkServer RD350 - TopSeller - 70D6	7	ThinkServer RS160 - TopSeller - 70TE	42
ThinkServer RD350 - TopSeller - 70D8	8	ThinkServer RS160 - TopSeller - 70TG	43
ThinkServer RD350 - TopSeller - 70QK	9	Towers	44
ThinkServer RD350 - TopSeller - 70QM	10	ThinkServer TD340	44
ThinkServer RD450	11	ThinkServer TD340 Platform Specifications	45
ThinkServer RD450 Platform Specifications	12	ThinkServer TD340 - TopSeller - 70B5	46
ThinkServer RD450 - TopSeller - 70DA	13	ThinkServer TD340 - TopSeller - 70B7 - 1 of 2	47
ThinkServer RD450 - TopSeller - 70DC	14	ThinkServer TD340 - TopSeller - 70B7 - 2 of 2	48
ThinkServer RD450 - TopSeller - 70DE	15	ThinkServer TD340 - 70B6	49
ThinkServer RD450 - TopSeller - 70DV	16	ThinkServer TD350	50
ThinkServer RD450 - TopSeller - 70Q9	17	ThinkServer TD350 Platform Specifications	51
ThinkServer RD450 - TopSeller - 70QQ	18	ThinkServer TD350 - TopSeller - 70DG	52
ThinkServer RD450 - TopSeller - 70QS	19	ThinkServer TD350 - TopSeller - 70DJ	53
ThinkServer RD450 - TopSeller - 70QW	20	ThinkServer TS150	54
ThinkServer RD550	21	ThinkServer TS150 Platform Specifications	54
ThinkServer RD550 Platform Specifications	22	ThinkServer TS150 - TopSeller - 70LV	55
ThinkServer RD550 - TopSeller - 70CV	23	ThinkServer TS150 - TopSeller - 70LX	56
ThinkServer RD550 - TopSeller - 70CX	24	ThinkServer TS440	57
ThinkServer RD650	25	ThinkServer TS440 Platform Specifications	58
ThinkServer RD650 Platform Specifications	26	ThinkServer TS440 - TopSeller - 70AN	59
ThinkServer RD650 - TopSeller - 70D0	27	ThinkServer TS440 - TopSeller - 70AQ - 1 of 2	60
ThinkServer RD650 - TopSeller - 70D2	28	ThinkServer TS440 - TopSeller - 70AQ - 2 of 2	61
ThinkServer RD650 - TopSeller - 70D4	29	ThinkServer TS440 - 70AL	62
ThinkServer RD650 - TopSeller - 70DR	30	ThinkServer TS440 - 70AM	63
ThinkServer RD650 - TopSeller - 70DT	31	Legal Information	64
ThinkServer RS140	32		
ThinkServer RS140 Platform Specifications	33		
ThinkServer RS140 - TopSeller - 70F3 - 1 of 2	34		
ThinkServer RS140 - TopSeller - 70F3 - 2 of 2	35		

Summary of Changes

This section describes the changes made in this version of ThinkServer PSREF and in previous version
This edition might also include minor corrections and editorial changes which are not identified

February 15, 2017 - Version 502

Additions in this update

- ▶ Add ThinkServer RS160 models announced September 2016

Withdrawals in this update

- ▶ ThinkServer TS140 had been end of life

October 12, 2016 - Version 496

Additions in this update

- ▶ New ThinkServer RS160 product announced September 2016
- ▶ New ThinkServer TS150 models announced August and October 2016

September 14, 2016 - Version 495

Additions in this update

- ▶ New ThinkServer RS160 product announced September 2016
- ▶ New ThinkServer TS140 models announced September 2016

April 6, 2016 - Version 487

Additions in this update

- ▶ New ThinkServer TD350, RD350, and RD450 models announced April 2016
- ▶ Add Intel Xeon E5-2600 v4 processors

March 23, 2016 - Version 486

Additions in this update

- ▶ New ThinkServer TS140 models announced March 2016

February 24, 2016 - Version 485

Additions in this update

- ▶ Add 8TB SATA and SAS 72K 6Gbs hard drive on ThinkServer RD350/RD450/RD550/RD650/TD350

December 30, 2015 - Version 483

Additions in this update

- ▶ Updates ThinkServer RS140, TD340 specifications
- ▶ Updates the most recent ThinkServer RS140, TD340 models

December 9, 2015 - Version 482

Additions in this update

- ▶ Updates ThinkServer TS140, TS440 specifications
- ▶ Updates the most recent ThinkServer TS140, TS440, RD350, RD450, RD550, RD650 models

October 28, 2015 - Version 480

Additions in this update

- ▶ New ThinkServer TS140 models announced October 2015

July 30, 2015 - Version 476

Additions in this update

- ▶ New ThinkServer TD350, RD550, and RD650 models announced July 2015

May 6, 2015 - Version 473

Additions in this update

- ▶ Add 95mm optical support on TD350
- ▶ Add Red Hat Enterprise Linux 7 support on RD350/RD450/RD550/RD650/TD350
- ▶ Add 32 x 25" bay support on TD350
- ▶ Add AnyBay and 25" PCIe SSD support on RD550/RD650

April 15, 2015 - Version 471

Additions in this update

- ▶ New ThinkServer TD350 models announced March 2015

March 25, 2015 - Version 470

Additions in this update

- ▶ New ThinkServer TS140 and TS440 models announced March 2015



ThinkServer RD350 Platform Specifications

Product Specifications Reference (PSREF)

Components	Specification																																								
Dimensions	1U rack. Height: 43 mm (1.7 in), width: 482 mm (19 in), depth: 781.5 mm (30.77 in)																																								
Weight	Minimum configuration: 13 kg (28.66 lb), maximum: 19.1 kg (42.11 lb)																																								
Processor	Up to two 105W Intel Xeon E5-2600 v4 or E5-2600 v3 family processors.																																								
	<table border="1"> <tbody> <tr><td>E5-2660 v4</td><td>14C/2GHz/35MB/105W/DDR4-2400</td></tr> <tr><td>E5-2650 v4</td><td>12C/2.2GHz/30MB/105W/DDR4-2400</td></tr> <tr><td>E5-2640 v4</td><td>10C/2.4GHz/25MB/90W/DDR4-2133</td></tr> <tr><td>E5-2630 v4</td><td>10C/2.2GHz/20MB/85W/DDR4-2133</td></tr> <tr><td>E5-2623 v4</td><td>4C/2.6GHz/10MB/85W/DDR4-2133</td></tr> <tr><td>E5-2620 v4</td><td>8C/2.1GHz/20MB/85W/DDR4-2133</td></tr> <tr><td>E5-2609 v4</td><td>8C/1.7GHz/20MB/85W/DDR4-1866</td></tr> <tr><td>E5-2603 v4</td><td>6C/1.7GHz/15MB/85W/DDR4-1866</td></tr> <tr><td>E5-2650L v4</td><td>14C/1.7GHz/35MB/65W/DDR4-2400</td></tr> <tr><td>E5-2630L v4</td><td>10C/1.8GHz/25MB/55W/DDR4-2133</td></tr> <tr><td>E5-2660 v3</td><td>10C/2.6GHz/25MB/105W/DDR4-2133</td></tr> <tr><td>E5-2650 v3</td><td>10C/2.3GHz/25MB/105W/DDR4-2133</td></tr> <tr><td>E5-2640 v3</td><td>8C/2.6GHz/20MB/90W/DDR4-1866</td></tr> <tr><td>E5-2630 v3</td><td>8C/2.4GHz/20MB/85W/DDR4-1866</td></tr> <tr><td>E5-2623 v3</td><td>4C/3GHz/10MB/105W/DDR4-1866</td></tr> <tr><td>E5-2620 v3</td><td>6C/2.4GHz/15MB/85W/DDR4-1866</td></tr> <tr><td>E5-2609 v3</td><td>6C/1.9GHz/15MB/85W/DDR4-1600</td></tr> <tr><td>E5-2603 v3</td><td>6C/1.6GHz/15MB/85W/DDR4-1600</td></tr> <tr><td>E5-2650L v3</td><td>12C/1.8GHz/30MB/65W/DDR4-2133</td></tr> <tr><td>E5-2630L v3</td><td>8C/1.8GHz/20MB/55W/DDR4-1866</td></tr> </tbody> </table>	E5-2660 v4	14C/2GHz/35MB/105W/DDR4-2400	E5-2650 v4	12C/2.2GHz/30MB/105W/DDR4-2400	E5-2640 v4	10C/2.4GHz/25MB/90W/DDR4-2133	E5-2630 v4	10C/2.2GHz/20MB/85W/DDR4-2133	E5-2623 v4	4C/2.6GHz/10MB/85W/DDR4-2133	E5-2620 v4	8C/2.1GHz/20MB/85W/DDR4-2133	E5-2609 v4	8C/1.7GHz/20MB/85W/DDR4-1866	E5-2603 v4	6C/1.7GHz/15MB/85W/DDR4-1866	E5-2650L v4	14C/1.7GHz/35MB/65W/DDR4-2400	E5-2630L v4	10C/1.8GHz/25MB/55W/DDR4-2133	E5-2660 v3	10C/2.6GHz/25MB/105W/DDR4-2133	E5-2650 v3	10C/2.3GHz/25MB/105W/DDR4-2133	E5-2640 v3	8C/2.6GHz/20MB/90W/DDR4-1866	E5-2630 v3	8C/2.4GHz/20MB/85W/DDR4-1866	E5-2623 v3	4C/3GHz/10MB/105W/DDR4-1866	E5-2620 v3	6C/2.4GHz/15MB/85W/DDR4-1866	E5-2609 v3	6C/1.9GHz/15MB/85W/DDR4-1600	E5-2603 v3	6C/1.6GHz/15MB/85W/DDR4-1600	E5-2650L v3	12C/1.8GHz/30MB/65W/DDR4-2133	E5-2630L v3	8C/1.8GHz/20MB/55W/DDR4-1866
	E5-2660 v4	14C/2GHz/35MB/105W/DDR4-2400																																							
	E5-2650 v4	12C/2.2GHz/30MB/105W/DDR4-2400																																							
	E5-2640 v4	10C/2.4GHz/25MB/90W/DDR4-2133																																							
	E5-2630 v4	10C/2.2GHz/20MB/85W/DDR4-2133																																							
	E5-2623 v4	4C/2.6GHz/10MB/85W/DDR4-2133																																							
	E5-2620 v4	8C/2.1GHz/20MB/85W/DDR4-2133																																							
	E5-2609 v4	8C/1.7GHz/20MB/85W/DDR4-1866																																							
	E5-2603 v4	6C/1.7GHz/15MB/85W/DDR4-1866																																							
	E5-2650L v4	14C/1.7GHz/35MB/65W/DDR4-2400																																							
	E5-2630L v4	10C/1.8GHz/25MB/55W/DDR4-2133																																							
	E5-2660 v3	10C/2.6GHz/25MB/105W/DDR4-2133																																							
	E5-2650 v3	10C/2.3GHz/25MB/105W/DDR4-2133																																							
	E5-2640 v3	8C/2.6GHz/20MB/90W/DDR4-1866																																							
	E5-2630 v3	8C/2.4GHz/20MB/85W/DDR4-1866																																							
	E5-2623 v3	4C/3GHz/10MB/105W/DDR4-1866																																							
	E5-2620 v3	6C/2.4GHz/15MB/85W/DDR4-1866																																							
	E5-2609 v3	6C/1.9GHz/15MB/85W/DDR4-1600																																							
	E5-2603 v3	6C/1.6GHz/15MB/85W/DDR4-1600																																							
E5-2650L v3	12C/1.8GHz/30MB/65W/DDR4-2133																																								
E5-2630L v3	8C/1.8GHz/20MB/55W/DDR4-1866																																								
Chipset	Intel C612 Platform Controller Hub (PCH)																																								
Memory DIMMs	16 DIMM sockets. 4 channels per processor, 2 DIMMs per channel. RDIMM or LRDIMM (cannot be intermixed), DDR4-2133 or DDR4-2400																																								
Memory capacity	512GB (RDIMM, 32GB x 16)/1024GB (LRDIMM, 64GB x 16), 2nd CPU is needed																																								
Memory protection	ECC, memory mirroring, lockstep, and memory sparing																																								
RAID controller	<table border="1"> <thead> <tr> <th>RAID controller</th> <th>Drive type</th> <th>RAID support</th> <th>Compatible models</th> </tr> </thead> <tbody> <tr> <td>Onboard RAID110i</td> <td>6Gbs SATA</td> <td>0/1/10, 5 with optional key</td> <td>4x3.5" HS/ES, 8x2.5" HS</td> </tr> <tr> <td>RAID500 PCIe</td> <td>6Gbs SAS/SATA</td> <td>0/1/10, 5/50 with optional key</td> <td>4x3.5" HS, 8x2.5" HS</td> </tr> <tr> <td>RAID520i PCIe</td> <td>12Gbs SAS/SATA</td> <td>0/1/10, 5/50 with optional key</td> <td>4x3.5" HS/ES, 8x2.5" HS</td> </tr> <tr> <td>RAID710 PCIe (1GB memory)</td> <td>6Gbs SAS/SATA</td> <td>0/1/10/5/50/6/60</td> <td>4x3.5" HS, 8x2.5" HS</td> </tr> <tr> <td>RAID720i PCIe</td> <td>12Gbs SAS/SATA</td> <td>0/1/10/5/50, 6/60 with optional cache</td> <td>4x3.5" HS/ES, 8x2.5" HS</td> </tr> </tbody> </table>	RAID controller	Drive type	RAID support	Compatible models	Onboard RAID110i	6Gbs SATA	0/1/10, 5 with optional key	4x3.5" HS/ES, 8x2.5" HS	RAID500 PCIe	6Gbs SAS/SATA	0/1/10, 5/50 with optional key	4x3.5" HS, 8x2.5" HS	RAID520i PCIe	12Gbs SAS/SATA	0/1/10, 5/50 with optional key	4x3.5" HS/ES, 8x2.5" HS	RAID710 PCIe (1GB memory)	6Gbs SAS/SATA	0/1/10/5/50/6/60	4x3.5" HS, 8x2.5" HS	RAID720i PCIe	12Gbs SAS/SATA	0/1/10/5/50, 6/60 with optional cache	4x3.5" HS/ES, 8x2.5" HS																
	RAID controller	Drive type	RAID support	Compatible models																																					
	Onboard RAID110i	6Gbs SATA	0/1/10, 5 with optional key	4x3.5" HS/ES, 8x2.5" HS																																					
	RAID500 PCIe	6Gbs SAS/SATA	0/1/10, 5/50 with optional key	4x3.5" HS, 8x2.5" HS																																					
	RAID520i PCIe	12Gbs SAS/SATA	0/1/10, 5/50 with optional key	4x3.5" HS/ES, 8x2.5" HS																																					
	RAID710 PCIe (1GB memory)	6Gbs SAS/SATA	0/1/10/5/50/6/60	4x3.5" HS, 8x2.5" HS																																					
RAID720i PCIe	12Gbs SAS/SATA	0/1/10/5/50, 6/60 with optional cache	4x3.5" HS/ES, 8x2.5" HS																																						
	Optional cache for RAID 710: CacheVault flash cache with super capacitor, CacheCade Pro, or FastPath.																																								
	Optional cache for RAID 720/AnyRAID 720i and 720ix: 1GB read-only memory or 1GB/2GB/4GB flash with super capacitor. Flash options include CacheVault, CacheCade Pro, and FastPath. 720ix must have cache.																																								
	<i>Note: RAID 50 and 60 are available on 8 x 2.5" models only.</i>																																								
Disk drive bays	Up to 4x3.5" hot-swap, 4x3.5" easy-swap, or 8x2.5" hot-swap disk bays on front. Supports external RDX tape drive via USB.																																								
Maximum internal storage	3.5" model: up to 32TB with 7.2K SATA or SAS HDD, up to 7.2TB with 10K SAS HDD, up to 2.4TB with 15K SAS HDD, or up to 6.4TB with SATA SSD. 3.5" ES model: up to 12TB with 7.2K SATA, up to 24TB with 7.2K SAS. 2.5" model: up to 16TB with 7.2K SATA HDD, up to 14.4TB with 10K SAS HDD, up to 4.8TB with 15K SAS HDD, or up to 12.8TB with SATA or SAS SSD																																								
SD module	Up to 2 SDHC flash cards via optional SD module, 8GB or 32GB each																																								
Optical drive	Optional one 9.5mm optical, DVD-ROM or DVD±RW.																																								
Network interfaces	One dedicated management port, two Gigabit Ethernet ports (RJ-45). Supports optional discrete network adapters via PCIe slots																																								
Security features	Power-on and administrator password. Optional TPM (TCG 1.2-compliant) Supports ThinkServer System Manager (TSM), optional TSM Premium. UEFI. Onboard Aspeed AST2400 graphics/management processor, IPMI 2.0-compliant baseboard management controller (BMC).																																								
Systems management	Control Panel LEDs shows the status of power, ID, network, system. Supports ThinkServer management software: Diagnostics, Deployment Manager, Energy Manager, System Manager, Partner Pack for VMware vCenter and Microsoft System Center Operations Manager, Power Planner																																								

Components	Specification														
Operating systems supported	Microsoft Windows Server 2016/2012 R2/2012/2008 R2. Windows Small Business Server 2011. Red Hat Enterprise Linux 6.5/6.6/7. SUSE Linux Enterprise Server 11. VMware vSphere (ESXi) 5.1 P5/5.5 U2/6.0														
Base warranty	1 or 3-year limited onsite service with 9x5/NBD														
Power supply	Up to two redundant hot-swap 450W/550W/750W power supplies. 450 W is 80 PLUS Gold qualified. 550W is 80 PLUS Platinum qualified. 750W is 80 PLUS Platinum or Titanium qualified. 750W Titanium is 200V - 240V, others are 110V - 240V.														
	<table border="1"> <thead> <tr> <th rowspan="2">Disk bay configuration</th> <th colspan="3">PSU requirements</th> </tr> <tr> <th>450W</th> <th>550W</th> <th>750W</th> </tr> </thead> <tbody> <tr> <td>4x3.5"</td> <td>•</td> <td>•</td> <td>•</td> </tr> <tr> <td>8x2.5"</td> <td>•</td> <td>•</td> <td>•</td> </tr> </tbody> </table>	Disk bay configuration	PSU requirements			450W	550W	750W	4x3.5"	•	•	•	8x2.5"	•	•
Disk bay configuration	PSU requirements														
	450W	550W	750W												
4x3.5"	•	•	•												
8x2.5"	•	•	•												
Graphics	Onboard Aspeed AST2400 with 16MB memory, one DisplayPort on front, one VGA on rear.														
Front ports	Two USB 2.0. One DisplayPort (one VGA on E5-2600 v4 models instead)														
Rear ports	One VGA, two USB 3.0, one RJ-45 (dedicated mgmt), two ethernet, one serial (9-pin)														
Cooling	6 (5+1, dual processors) or 4 (3+1, single processor) fans, non-hot swap														
Noise emissions	Operating: < 6.5 Bels. Idle: < 5.4 Bels (Maximum configuration)														
Environmental specification	Temperature - operating	50 °F to 95 °F (10 °C to 35 °C)													
	Temperature - non operating (no package)	-10 °C to 60 °C													
	Temperature - non operating (with package)	-40 °C to 70 °C													
	Altitude - operating	(Unpressurized): 0-10000ft (0-3048m)													
	Humidity - operating	8%-90%, non-condensing													
	Humidity - storage (with package)	8%-90%, non-condensing													

Expansion slots

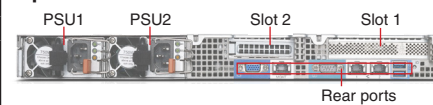

Up to two PCIe 3.0 x 16 slots:

Slot 1	PCIe 3.0 x16, half length, full height, by CPU1
Slot 2 for dual processors model	PCIe 3.0 x16, low-profile, half length, requires 2nd riser card and 2nd CPU
Slot 2 for single processor model	PCIe 3.0 x16 (x8 electrical), low-profile, half length, by CPU1, requires 2nd riser card

For a list of all supported options, please see https://download.lenovo.com/pccbbs/options_iso/ocm_september_2016_thinkserver.xlsx sheet

Model	Region	Processor	2nd CPU	Memory	RAID Controller	Disk Bays	Storage	Slots	Optical	Add-on NIC	TPM	System Mgmt	OS	Warranty	Power Supply	Ann Date (m/y)
70D6001YUX	US	1xE5-2603 v3 6C/1.6GHz/15MB/85W/DDR4-1600	4XG0F28848	1x4GB RDIMM DDR4-2133 ECC	RAID 110i	4x3.5" HS	Open	None	9.5mm DVD±RW	None	TPM	TSM	None	3-year	550Wx1 Platinum	12/14
70D60020UX	US	1xE5-2609 v3 6C/1.9GHz/15MB/85W/DDR4-1600	4XG0F28847	1x8GB RDIMM DDR4-2133 ECC	RAID 110i	4x3.5" HS	Open	1xFHHL	9.5mm DVD±RW	None	TPM	TSM	None	3-year	550Wx1 Platinum	12/14
70D60021UX	US	1xE5-2620 v3 6C/2.4GHz/15MB/85W/DDR4-1866	4XG0F28846	1x8GB RDIMM DDR4-2133 ECC	RAID 110i	4x3.5" HS	Open	1xFHHL	9.5mm DVD±RW	None	TPM	TSM	None	3-year	550Wx1 Platinum	12/14
70D60022UX	US	2xE5-2640 v3 8C/2.6GHz/20MB/90W/DDR4-1866	-	2x8GB RDIMM DDR4-2133 ECC	RAID 110i	4x3.5" HS	Open	1xFHHL+1xLP (2x16)	9.5mm DVD±RW	None	TPM	TSM	None	3-year	550Wx1 Platinum	12/14
70D60023UX	US	1xE5-2650 v3 10C/2.3GHz/25MB/105W/DDR4-2133	4XG0F28843	1x8GB RDIMM DDR4-2133 ECC	RAID 110i	4x3.5" HS	Open	1xFHHL	9.5mm DVD±RW	None	TPM	TSM	None	3-year	550Wx1 Platinum	12/14
70D60024UX	US	1xE5-2660 v3 10C/2.6GHz/25MB/105W/DDR4-2133	4XG0F28842	1x8GB RDIMM DDR4-2133 ECC	RAID 110i	4x3.5" HS	Open	1xFHHL	9.5mm DVD±RW	None	TPM	TSM	None	3-year	550Wx1 Platinum	12/14
70D60025UX	US	1xE5-2603 v3 6C/1.6GHz/15MB/85W/DDR4-1600	4XG0F28848	1x8GB RDIMM DDR4-2133 ECC	RAID 110i	4x3.5" HS	Open	1xFHHL	9.5mm DVD±RW	None	TPM	TSM	None	3-year	550Wx1 Platinum	12/14
70D60026UX	US	1xE5-2630 v3 8C/2.4GHz/20MB/85W/DDR4-1866	4XG0F28845	1x8GB RDIMM DDR4-2133 ECC	RAID 110i	4x3.5" HS	Open	1xFHHL	9.5mm DVD±RW	None	TPM	TSM	None	3-year	550Wx1 Platinum	12/14
70D60035UX	US	1xE5-2620 v3 6C/2.4GHz/15MB/85W/DDR4-1866	4XG0F28846	2x8GB RDIMM DDR4-2133 ECC	RAID 110i	4x3.5" HS	2x1TB HDD 7.2K 3.5" SATA6Gbs	1xFHHL	9.5mm DVD±RW	None	TPM	TSM Premium	None	3-year	750Wx2 Platinum	02/15
70D6003DUX	US	2xE5-2620 v3 6C/2.4GHz/15MB/85W/DDR4-1866	-	2x16GB RDIMM DDR4-2133 ECC	RAID 110i	4x3.5" HS	Open	1xFHHL+1xLP (2x16)	9.5mm DVD±RW	None	TPM	TSM	None	3-year	550Wx2 Platinum	09/15
70D6003PUX	US	1xE5-2609 v3 6C/1.9GHz/15MB/85W/DDR4-1600	4XG0F28847	4x16GB RDIMM DDR4-2133 ECC	RAID 110i	4x3.5" HS	4x1TB HDD 7.2K 3.5" SATA6Gbs	None	None	None	TPM	TSM Premium	None	3-year	550Wx2 Platinum	11/15

Model	Region	Processor	2nd CPU	Memory	RAID Controller	Disk Bays	Storage	Slots	Optical	Add-on NIC	TPM	System Mgmt	OS	Warranty	Power Supply	Ann Date (m/y)
70D8001TUX	US	1xE5-2603 v3 6C/1.6GHz/15MB/85W/DDR4-1600	4XG0F28848	1x4GB RDIMM DDR4-2133 ECC	RAID 110i	8x2.5" HS	Open	None	9.5mm DVD±RW	None	TPM	TSM	None	3-year	550Wx1 Platinum	12/14
70D8001UUX	US	1xE5-2609 v3 6C/1.9GHz/15MB/85W/DDR4-1600	4XG0F28847	1x8GB RDIMM DDR4-2133 ECC	RAID 110i	8x2.5" HS	Open	1xFHHL	9.5mm DVD±RW	None	TPM	TSM	None	3-year	550Wx1 Platinum	12/14
70D8001VUX	US	1xE5-2620 v3 6C/2.4GHz/15MB/85W/DDR4-1866	4XG0F28846	1x8GB RDIMM DDR4-2133 ECC	RAID 110i	8x2.5" HS	Open	1xFHHL	9.5mm DVD±RW	None	TPM	TSM	None	3-year	550Wx1 Platinum	12/14
70D8001WUX	US	1xE5-2640 v3 8C/2.6GHz/20MB/90W/DDR4-1866	4XG0F28844	1x8GB RDIMM DDR4-2133 ECC	RAID 110i	8x2.5" HS	Open	1xFHHL	9.5mm DVD±RW	None	TPM	TSM	None	3-year	550Wx1 Platinum	12/14
70D8001XUX	US	1xE5-2650 v3 10C/2.3GHz/25MB/105W/DDR4-2133	4XG0F28843	1x8GB RDIMM DDR4-2133 ECC	RAID 110i	8x2.5" HS	Open	1xFHHL	9.5mm DVD±RW	None	TPM	TSM	None	3-year	550Wx1 Platinum	12/14
70D8001YUX	US	1xE5-2660 v3 10C/2.6GHz/25MB/105W/DDR4-2133	4XG0F28842	1x8GB RDIMM DDR4-2133 ECC	RAID 110i	8x2.5" HS	Open	1xFHHL	9.5mm DVD±RW	None	TPM	TSM	None	3-year	550Wx1 Platinum	12/14
70D80020UX	US	1xE5-2603 v3 6C/1.6GHz/15MB/85W/DDR4-1600	4XG0F28848	1x8GB RDIMM DDR4-2133 ECC	RAID 110i	8x2.5" HS	Open	1xFHHL	9.5mm DVD±RW	None	TPM	TSM	None	3-year	550Wx1 Platinum	12/14
70D80021UX	US	1xE5-2630 v3 8C/2.4GHz/20MB/85W/DDR4-1866	4XG0F28845	1x8GB RDIMM DDR4-2133 ECC	RAID 110i	8x2.5" HS	Open	1xFHHL	9.5mm DVD±RW	None	TPM	TSM	None	3-year	550Wx1 Platinum	12/14

Model	Region	Processor	2nd CPU	Memory	RAID Controller	Disk Bays	Storage	Slots	Optical	Add-on NIC	TPM	System Mgmt	OS	Warranty	Power Supply	Ann Date (m/y)
70QK000VUX	US	1xE5-2603 v4 6C/1.7GHz/15MB/85W/DDR4-1866	4XG0G89089	1x16GB RDIMM DDR4-2400 ECC	RAID 110i	4x3.5" HS	Open	1xFHHL	None	None	TPM	TSM	None	3-year	750Wx1 Platinum	04/16
70QK000WUX	US	1xE5-2609 v4 8C/1.7GHz/20MB/85W/DDR4-1866	4XG0G89084	1x16GB RDIMM DDR4-2400 ECC	RAID 110i	4x3.5" HS	Open	1xFHHL	None	None	TPM	TSM	None	3-year	750Wx1 Platinum	04/16
70QK000XUX	US	1xE5-2620 v4 8C/2.1GHz/20MB/85W/DDR4-2133	4XG0G89079	1x16GB RDIMM DDR4-2400 ECC	RAID 110i	4x3.5" HS	Open	1xFHHL	None	None	TPM	TSM	None	3-year	750Wx1 Platinum	04/16
70QK000YUX	US	1xE5-2630 v4 10C/2.2GHz/20MB/85W/DDR4-2133	4XG0G89074	1x16GB RDIMM DDR4-2400 ECC	RAID 110i	4x3.5" HS	Open	1xFHHL	None	None	TPM	TSM	None	3-year	750Wx1 Platinum	04/16
70QK0010UX	US	1xE5-2640 v4 10C/2.4GHz/25MB/90W/DDR4-2133	4XG0G89069	1x16GB RDIMM DDR4-2400 ECC	RAID 110i	4x3.5" HS	Open	1xFHHL	None	None	TPM	TSM	None	3-year	750Wx1 Platinum	04/16
70QK0011UX	US	1xE5-2650 v4 12C/2.2GHz/30MB/105W/DDR4-2400	4XG0G89064	1x16GB RDIMM DDR4-2400 ECC	RAID 110i	4x3.5" HS	Open	1xFHHL	None	None	TPM	TSM	None	3-year	750Wx1 Platinum	04/16
70QK0012UX	US	1xE5-2660 v4 14C/2GHz/35MB/105W/DDR4-2400	4XG0G89059	1x16GB RDIMM DDR4-2400 ECC	RAID 110i	4x3.5" HS	Open	1xFHHL	None	None	TPM	TSM	None	3-year	750Wx1 Platinum	04/16
70QK0013UX	US	1xE5-2609 v4 8C/1.7GHz/20MB/85W/DDR4-1866	4XG0G89084	4x16GB RDIMM DDR4-2400 ECC	RAID 110i	4x3.5" HS	4x1TB HDD 7.2K 3.5" SATA6Gbs	1xFHHL	None	None	TPM	TSM Premium	None	3-year	750Wx2 Platinum	04/16
70QK0014UX	US	2xE5-2620 v4 8C/2.1GHz/20MB/85W/DDR4-2133	-	2x16GB RDIMM DDR4-2400 ECC	RAID 110i	4x3.5" HS	Open	1xFHHL+1xLP (2x16)	None	None	TPM	TSM Premium	None	3-year	750Wx2 Platinum	04/16

Model	Region	Processor	2nd CPU	Memory	RAID Controller	Disk Bays	Storage	Slots	Optical	Add-on NIC	TPM	System Mgmt	OS	Warranty	Power Supply	Ann Date (m/y)
70QM0010UX	US	1xE5-2603 v4 6C/1.7GHz/15MB/85W/DDR4-1866	4XG0G89089	1x16GB RDIMM DDR4-2400 ECC	RAID 110i	8x2.5" HS	Open	1xFHHL	None	None	TPM	TSM	None	3-year	750Wx1 Platinum	04/16
70QM0011UX	US	1xE5-2609 v4 8C/1.7GHz/20MB/85W/DDR4-1866	4XG0G89084	1x16GB RDIMM DDR4-2400 ECC	RAID 110i	8x2.5" HS	Open	1xFHHL	None	None	TPM	TSM	None	3-year	750Wx1 Platinum	04/16
70QM0012UX	US	1xE5-2620 v4 8C/2.1GHz/20MB/85W/DDR4-2133	4XG0G89079	1x16GB RDIMM DDR4-2400 ECC	RAID 110i	8x2.5" HS	Open	1xFHHL	None	None	TPM	TSM	None	3-year	750Wx1 Platinum	04/16
70QM0013UX	US	1xE5-2630L v4 10C/1.8GHz/25MB/55W/DDR4-2133	4XG0G89104	1x16GB RDIMM DDR4-2400 ECC	RAID 110i	8x2.5" HS	Open	1xFHHL	None	None	TPM	TSM	None	3-year	750Wx1 Platinum	04/16
70QM0014UX	US	1xE5-2630 v4 10C/2.2GHz/20MB/85W/DDR4-2133	4XG0G89074	1x16GB RDIMM DDR4-2400 ECC	RAID 110i	8x2.5" HS	Open	1xFHHL	None	None	TPM	TSM	None	3-year	750Wx1 Platinum	04/16
70QM0015UX	US	1xE5-2640 v4 10C/2.4GHz/25MB/90W/DDR4-2133	4XG0G89069	1x16GB RDIMM DDR4-2400 ECC	RAID 110i	8x2.5" HS	Open	1xFHHL	None	None	TPM	TSM	None	3-year	750Wx1 Platinum	04/16
70QM0016UX	US	1xE5-2650 v4 12C/2.2GHz/30MB/105W/DDR4-2400	4XG0G89064	1x16GB RDIMM DDR4-2400 ECC	RAID 110i	8x2.5" HS	Open	1xFHHL	None	None	TPM	TSM	None	3-year	750Wx1 Platinum	04/16
70QM0017UX	US	1xE5-2660 v4 14C/2GHz/35MB/105W/DDR4-2400	4XG0G89059	1x16GB RDIMM DDR4-2400 ECC	RAID 110i	8x2.5" HS	Open	1xFHHL	None	None	TPM	TSM	None	3-year	750Wx1 Platinum	04/16



ThinkServer RD450 Platform Specifications

Product Specifications Reference (PSREF)

Components	Specification																																								
Dimensions	2U rack. Height: 87 mm (3.4 in), width: 482 mm (19 in), depth: 764 mm (30 in)																																								
Weight	Minimum configuration: 16 kg (35.3 lb), maximum: 27 kg (59.52 lb)																																								
Processor	Up to two 105W Intel Xeon E5-2600 v4 or E5-2600 v3 family processors.																																								
	E5-2660 v4	14C/2GHz/35MB/105W/DDR4-2400																																							
	E5-2650 v4	12C/2.2GHz/30MB/105W/DDR4-2400																																							
	E5-2640 v4	10C/2.4GHz/25MB/90W/DDR4-2133																																							
	E5-2630 v4	10C/2.2GHz/20MB/85W/DDR4-2133																																							
	E5-2623 v4	4C/2.6GHz/10MB/85W/DDR4-2133																																							
	E5-2620 v4	8C/2.1GHz/20MB/85W/DDR4-2133																																							
	E5-2609 v4	8C/1.7GHz/20MB/85W/DDR4-1866																																							
	E5-2603 v4	6C/1.7GHz/15MB/85W/DDR4-1866																																							
	E5-2650L v4	14C/1.7GHz/35MB/65W/DDR4-2400																																							
	E5-2630L v4	10C/1.8GHz/25MB/55W/DDR4-2133																																							
	E5-2660 v3	10C/2.6GHz/25MB/105W/DDR4-2133																																							
	E5-2650 v3	10C/2.3GHz/25MB/105W/DDR4-2133																																							
	E5-2640 v3	8C/2.6GHz/20MB/90W/DDR4-1866																																							
	E5-2630 v3	8C/2.4GHz/20MB/85W/DDR4-1866																																							
	E5-2623 v3	4C/3GHz/10MB/105W/DDR4-1866																																							
	E5-2620 v3	6C/2.4GHz/15MB/85W/DDR4-1866																																							
E5-2609 v3	6C/1.9GHz/15MB/85W/DDR4-1600																																								
E5-2603 v3	6C/1.6GHz/15MB/85W/DDR4-1600																																								
E5-2650L v3	12C/1.8GHz/30MB/65W/DDR4-2133																																								
E5-2630L v3	8C/1.8GHz/20MB/55W/DDR4-1866																																								
Chipset	Intel C612 Platform Controller Hub (PCH)																																								
Memory DIMMs	16 DIMM sockets with 8 channels. 4 channels per processor, 2 DIMMs per channel. RDIMM or LRDIMM (cannot be intermixed), DDR4, DDR4-2133 or DDR4-2400																																								
Memory capacity	512GB (RDIMM, 32GB x 16)/1024GB (LRDIMM, 64GB x 16), 2nd CPU is needed																																								
Memory protection	ECC, memory mirroring, lockstep, and memory sparing																																								
RAID controller	<table border="1"> <thead> <tr> <th>RAID controller</th> <th>Drive type</th> <th>RAID support</th> <th>Compatible models</th> </tr> </thead> <tbody> <tr> <td>Onboard RAID110i</td> <td>6Gbs SATA</td> <td>0/1/10, 5 with optional key</td> <td>8x3.5" HS/ES, 8x2.5" HS</td> </tr> <tr> <td>RAID500 PCIe</td> <td>6Gbs SAS/SATA</td> <td>0/1/10, 5/50 with optional key</td> <td>8x3.5" HS</td> </tr> <tr> <td>RAID520i PCIe</td> <td>12Gbs SAS/SATA</td> <td>0/1/10, 5/50 with optional key</td> <td>8x3.5" HS/ES, 8x2.5" HS</td> </tr> <tr> <td>RAID710 PCIe (1GB memory)</td> <td>6Gbs SAS/SATA</td> <td>0/1/10/5/50/6/60</td> <td>8x3.5" HS</td> </tr> <tr> <td>RAID720i PCIe</td> <td>12Gbs SAS/SATA</td> <td>0/1/10/5/50, 6/60 with optional cache</td> <td>8x3.5" HS/ES, 8x2.5" HS</td> </tr> <tr> <td>AnyRAID 110i</td> <td>6Gbs SATA</td> <td>0/1/10, 5 with optional key</td> <td>8x2.5" HS</td> </tr> <tr> <td>AnyRAID 510i</td> <td>6Gbs SAS/SATA</td> <td>0/1/10, 5/50 with optional key</td> <td>8x2.5" HS</td> </tr> <tr> <td>AnyRAID 720i</td> <td>12Gbs SAS/SATA</td> <td>0/1/10/5/50, 6/60 with optional cache</td> <td>8x2.5" HS</td> </tr> <tr> <td>AnyRAID 720ix</td> <td>12Gbs SAS/SATA</td> <td>0/1/10/5/50/6/60</td> <td>16/24x2.5" HS, 8x2.5" HS+optional tape</td> </tr> </tbody> </table>	RAID controller	Drive type	RAID support	Compatible models	Onboard RAID110i	6Gbs SATA	0/1/10, 5 with optional key	8x3.5" HS/ES, 8x2.5" HS	RAID500 PCIe	6Gbs SAS/SATA	0/1/10, 5/50 with optional key	8x3.5" HS	RAID520i PCIe	12Gbs SAS/SATA	0/1/10, 5/50 with optional key	8x3.5" HS/ES, 8x2.5" HS	RAID710 PCIe (1GB memory)	6Gbs SAS/SATA	0/1/10/5/50/6/60	8x3.5" HS	RAID720i PCIe	12Gbs SAS/SATA	0/1/10/5/50, 6/60 with optional cache	8x3.5" HS/ES, 8x2.5" HS	AnyRAID 110i	6Gbs SATA	0/1/10, 5 with optional key	8x2.5" HS	AnyRAID 510i	6Gbs SAS/SATA	0/1/10, 5/50 with optional key	8x2.5" HS	AnyRAID 720i	12Gbs SAS/SATA	0/1/10/5/50, 6/60 with optional cache	8x2.5" HS	AnyRAID 720ix	12Gbs SAS/SATA	0/1/10/5/50/6/60	16/24x2.5" HS, 8x2.5" HS+optional tape
	RAID controller	Drive type	RAID support	Compatible models																																					
	Onboard RAID110i	6Gbs SATA	0/1/10, 5 with optional key	8x3.5" HS/ES, 8x2.5" HS																																					
	RAID500 PCIe	6Gbs SAS/SATA	0/1/10, 5/50 with optional key	8x3.5" HS																																					
	RAID520i PCIe	12Gbs SAS/SATA	0/1/10, 5/50 with optional key	8x3.5" HS/ES, 8x2.5" HS																																					
	RAID710 PCIe (1GB memory)	6Gbs SAS/SATA	0/1/10/5/50/6/60	8x3.5" HS																																					
	RAID720i PCIe	12Gbs SAS/SATA	0/1/10/5/50, 6/60 with optional cache	8x3.5" HS/ES, 8x2.5" HS																																					
	AnyRAID 110i	6Gbs SATA	0/1/10, 5 with optional key	8x2.5" HS																																					
	AnyRAID 510i	6Gbs SAS/SATA	0/1/10, 5/50 with optional key	8x2.5" HS																																					
	AnyRAID 720i	12Gbs SAS/SATA	0/1/10/5/50, 6/60 with optional cache	8x2.5" HS																																					
AnyRAID 720ix	12Gbs SAS/SATA	0/1/10/5/50/6/60	16/24x2.5" HS, 8x2.5" HS+optional tape																																						
Optional cache for RAID 710: CacheVault flash cache with super capacitor, CacheCade Pro, or FastPath.																																									
Optional cache for RAID 720/AnyRAID 720i and 720ix: 1GB read-only memory or 1GB/2GB/4GB flash with super capacitor. Flash options include CacheVault, CacheCade Pro, and FastPath. 720ix must have cache.																																									
Disk drive bays	Up to 8x3.5" hot-swap, 8x3.5" easy-swap, or 24x2.5" hot-swap disk bays on front. Up to one internal LTO-6 SAS tape drive on 8x2.5" and 720ix model, or external RDX tape drive via USB.																																								
Maximum internal storage	3.5" HS model: up to 64TB with 7.2K SATA or SAS HDD, up to 14.4TB with 10K SAS HDD, up to 4.8TB with 15K SAS HDD, or up to 12.8TB with SATA SSD. 3.5" ES model: up to 24TB with 7.2K SATA, up to 48TB with 7.2K SAS. 2.5" HS model: up to 48TB with 7.2K SATA HDD, up to 43.2TB with 10K SAS HDD, up to 14.4TB with 15K SAS HDD, or up to 38.4TB with SATA or SAS SSD																																								
SD module	Up to 2 SDHC flash cards via optional SD module, 8GB or 32GB each																																								
PCIe SSD adapter	Supports 1.6TB or 3.2TB SSD via PCIe adapter																																								
Optical drive	Optional one 9.5mm optical on 3.5" or 8/16 x 2.5" models, DVD-ROM or DVD±RW.																																								

Components	Specification																																		
Network interfaces	One dedicated management port, two Gigabit Ethernet ports. Supports optional discrete network adapters via PCIe slots																																		
Security features	Power-on and administrator password. Optional TPM (TCG 1.2-compliant)																																		
Systems management	Supports ThinkServer System Manager (TSM), optional TSM Premium. UEFI. Onboard Aspeed AST2400 graphics/management processor, IPMI 2.0-compliant baseboard management controller (BMC). Control Panel LEDs shows the status of power, ID, network, system. Supports ThinkServer management software: Diagnostics, Deployment Manager, Energy Manager, System Manager, Partner Pack for VMware vCenter and Microsoft System Center Operations Manager, Power Planner																																		
Operating systems supported	Microsoft Windows Server 2016/2012 R2/2012/2008 R2. Windows Small Business Server 2011. Red Hat Enterprise Linux 6.5/6.6/7. SUSE Linux Enterprise Server 11. VMware vSphere (ESXi) 5.1 P5/5.5 U2/6.0																																		
Base warranty	1 or 3-year limited onsite service with 9x5/NBD																																		
Power supply	Up to two redundant hot-swap 450W/550W/750W/1100W power supplies. 450 W is 80 PLUS Gold qualified. 550W and 1100W are 80 PLUS Platinum qualified. 750W is 80 PLUS Platinum or Titanium qualified. 750W Titanium is 200V - 240V, others are 110V - 240V.																																		
	<table border="1"> <thead> <tr> <th>Disk bay configuration</th> <th colspan="4">PSU requirements</th> </tr> <tr> <th></th> <th>450W</th> <th>550W</th> <th>750W</th> <th>1100W</th> </tr> </thead> <tbody> <tr> <td>8x3.5"</td> <td>•</td> <td>•</td> <td>•</td> <td>•</td> </tr> <tr> <td>8x2.5"</td> <td>•</td> <td>•</td> <td>•</td> <td>•</td> </tr> <tr> <td>8x2.5" + Tape</td> <td>•</td> <td>•</td> <td>•</td> <td>•</td> </tr> <tr> <td>16x2.5"</td> <td>•</td> <td>•</td> <td>•</td> <td>•</td> </tr> <tr> <td>24x2.5"</td> <td>•</td> <td>•</td> <td>•</td> <td>•</td> </tr> </tbody> </table>	Disk bay configuration	PSU requirements					450W	550W	750W	1100W	8x3.5"	•	•	•	•	8x2.5"	•	•	•	•	8x2.5" + Tape	•	•	•	•	16x2.5"	•	•	•	•	24x2.5"	•	•	•
Disk bay configuration	PSU requirements																																		
	450W	550W	750W	1100W																															
8x3.5"	•	•	•	•																															
8x2.5"	•	•	•	•																															
8x2.5" + Tape	•	•	•	•																															
16x2.5"	•	•	•	•																															
24x2.5"	•	•	•	•																															
Graphics	Onboard Aspeed AST2400 with 16MB memory																																		
Front ports	Two USB 2.0. One DisplayPort (one VGA on E5-2600 v4 models instead)																																		
Rear ports	One VGA, two USB 3.0, one RJ-45 (dedicated mgmt), two ethernet, one serial (9-pin)																																		
Cooling	4 (3+1, dual processors) or 3 (2+1, single processor) fans, non-hot swap																																		
Noise emissions	Operating: < 6.5 Bels. Idle: < 5.6 Bels (Maximum configuration)																																		
Environmental specification	Temperature - operating	50 °F to 95 °F (10 °C to 35 °C)																																	
	Temperature - non operating (no package)	-10 °C to 60 °C																																	
	Temperature - non operating (with package)	-40 °C to 70 °C																																	
	Altitude - operating	(Unpressurized): 0-10000ft (0-3048m)																																	
	Humidity - operating	8%-90%, non-condensing																																	
Humidity - storage (with package)	8%-90%, non-condensing																																		

Expansion slots



Slot 1 (riser card 1)	PCIe 3.0 x8, half length, full height, CPU1
Slot 2 (riser card 1)	PCIe 3.0 x8, half length, full height, CPU1
Slot 3 (riser card 2)	PCIe 3.0 x8, low-profile, half length, CPU2, requires 2nd riser card and 2nd CPU
Slot 4 (riser card 2)	PCIe 3.0 x8, low-profile, half length, CPU2, requires 2nd riser card and 2nd CPU
Slot 5 (riser card 2)	PCIe 3.0 x8, low-profile, half length, CPU1, requires 2nd riser card
Slot 6 (onboard)	PCIe 3.0 x16 (x8 elec), low-profile, half length, requires 2nd CPU

For a list of all supported options, please see https://download.lenovo.com/pccbbs/options_iso/ocm_september_2016_thinkserver.xlsx sheet

Model	Region	Processor	2nd CPU	Memory	RAID Controller	Disk Bays	Storage	Slots	Optical	Add-on NIC	TPM	System Mgmt	OS	Warranty	Power Supply	Ann Date (m/y)
70DA000XUX	US	1xE5-2603 v3 6C/1.6GHz/15MB/85W/DDR4-1600	4XG0F28860	1x4GB RDIMM DDR4-2133 ECC	110i (AnyRAID)	8x2.5" HS	Open	None	9.5mm DVD±RW	None	TPM	TSM	None	3-year	550Wx1 Platinum	12/14
70DA000YUX	US	1xE5-2609 v3 6C/1.9GHz/15MB/85W/DDR4-1600	4XG0F28859	1x8GB RDIMM DDR4-2133 ECC	110i (AnyRAID)	8x2.5" HS	Open	2xFH HL	9.5mm DVD±RW	None	TPM	TSM	None	3-year	550Wx1 Platinum	12/14
70DA0010UX	US	1xE5-2620 v3 6C/2.4GHz/15MB/85W/DDR4-1866	4XG0F28858	1x8GB RDIMM DDR4-2133 ECC	110i (AnyRAID)	8x2.5" HS	Open	2xFH HL	9.5mm DVD±RW	None	TPM	TSM	None	3-year	550Wx1 Platinum	12/14
70DA0011UX	US	1xE5-2630 v3 8C/2.4GHz/20MB/85W/DDR4-1866	4XG0F28857	1x8GB RDIMM DDR4-2133 ECC	110i (AnyRAID)	8x2.5" HS	Open	2xFH HL	9.5mm DVD±RW	None	TPM	TSM	None	3-year	550Wx1 Platinum	12/14
70DA0012UX	US	1xE5-2640 v3 8C/2.6GHz/20MB/90W/DDR4-1866	4XG0F28856	1x8GB RDIMM DDR4-2133 ECC	110i (AnyRAID)	8x2.5" HS	Open	2xFH HL	9.5mm DVD±RW	None	TPM	TSM	None	3-year	550Wx1 Platinum	12/14
70DA0013UX	US	1xE5-2660 v3 10C/2.6GHz/25MB/105W/DDR4-2133	4XG0F28854	1x8GB RDIMM DDR4-2133 ECC	110i (AnyRAID)	8x2.5" HS	Open	2xFH HL	9.5mm DVD±RW	None	TPM	TSM	None	3-year	550Wx1 Platinum	12/14
70DA0014UX	US	1xE5-2603 v3 6C/1.6GHz/15MB/85W/DDR4-1600	4XG0F28860	1x8GB RDIMM DDR4-2133 ECC	110i (AnyRAID)	8x2.5" HS	Open	2xFH HL	None	None	TPM	TSM	None	3-year	550Wx1 Platinum	12/14

Model	Region	Processor	2nd CPU	Memory	RAID Controller	Disk Bays	Storage	Slots	Optical	Add-on NIC	TPM	System Mgmt	OS	Warranty	Power Supply	Ann Date (m/y)
70DC001CUX	US	1xE5-2603 v3 6C/1.6GHz/15MB/85W/DDR4-1600	4XG0F28860	1x4GB RDIMM DDR4-2133 ECC	Onboard 110i (PCIe)	8x3.5" HS	Open	None	9.5mm DVD±RW	None	TPM	TSM	None	3-year	550Wx1 Platinum	12/14
70DC001DUX	US	1xE5-2609 v3 6C/1.9GHz/15MB/85W/DDR4-1600	4XG0F28859	1x8GB RDIMM DDR4-2133 ECC	Onboard 110i (PCIe)	8x3.5" HS	Open	2xFH HL	9.5mm DVD±RW	None	TPM	TSM	None	3-year	550Wx1 Platinum	12/14
70DC001EUX	US	1xE5-2620 v3 6C/2.4GHz/15MB/85W/DDR4-1866	4XG0F28858	1x8GB RDIMM DDR4-2133 ECC	Onboard 110i (PCIe)	8x3.5" HS	Open	2xFH HL	9.5mm DVD±RW	None	TPM	TSM	None	3-year	550Wx1 Platinum	12/14
70DC001FUX	US	1xE5-2630 v3 8C/2.4GHz/20MB/85W/DDR4-1866	4XG0F28857	1x8GB RDIMM DDR4-2133 ECC	Onboard 110i (PCIe)	8x3.5" HS	Open	2xFH HL	9.5mm DVD±RW	None	TPM	TSM	None	3-year	550Wx1 Platinum	12/14
70DC001GUX	US	1xE5-2640 v3 8C/2.6GHz/20MB/90W/DDR4-1866	4XG0F28856	1x8GB RDIMM DDR4-2133 ECC	Onboard 110i (PCIe)	8x3.5" HS	Open	2xFH HL	9.5mm DVD±RW	None	TPM	TSM	None	3-year	550Wx1 Platinum	12/14
70DC001HUX	US	1xE5-2650 v3 10C/2.3GHz/25MB/105W/DDR4-2133	4XG0F28855	1x8GB RDIMM DDR4-2133 ECC	Onboard 110i (PCIe)	8x3.5" HS	Open	2xFH HL	9.5mm DVD±RW	None	TPM	TSM	None	3-year	550Wx1 Platinum	12/14
70DC001JUX	US	1xE5-2660 v3 10C/2.6GHz/25MB/105W/DDR4-2133	4XG0F28854	1x8GB RDIMM DDR4-2133 ECC	Onboard 110i (PCIe)	8x3.5" HS	Open	2xFH HL	9.5mm DVD±RW	None	TPM	TSM	None	3-year	550Wx1 Platinum	12/14
70DC001KUX	US	1xE5-2603 v3 6C/1.6GHz/15MB/85W/DDR4-1600	4XG0F28860	1x8GB RDIMM DDR4-2133 ECC	Onboard 110i (PCIe)	8x3.5" HS	Open	2xFH HL	9.5mm DVD±RW	None	TPM	TSM	None	3-year	550Wx1 Platinum	12/14
70DC002EUX	US	1xE5-2620 v3 6C/2.4GHz/15MB/85W/DDR4-1866	4XG0F28858	2x8GB RDIMM DDR4-2133 ECC	Onboard 110i (PCIe)	8x3.5" HS	2x1TB HDD 7.2K 3.5" SATA6Gbs	2xFH HL	9.5mm DVD±RW	None	TPM	TSM Premium	None	3-year	750Wx2 Platinum	02/15
70DC002GUX	US	2xE5-2620 v3 6C/2.4GHz/15MB/85W/1866MH	-	2x16GB RDIMM DDR4-2133 ECC	Onboard 110i (PCIe)	8x3.5" HS	Open	2xFH HL+4xLP HL	9.5mm DVD±RW	None	TPM	TSM Premium	None	3-year	750Wx2 Platinum	09/15
70DC002UUX	US	1xE5-2630 v3 8C/2.4GHz/20MB/85W/DDR4-1866	4XG0F28857	4x16GB RDIMM DDR4-2133 ECC	Onboard 110i (PCIe)	8x3.5" HS	4x1TB HDD 7.2K 3.5" SATA6Gbs	None	None	None	TPM	TSM Premium	None	3-year	550Wx2 Platinum	11/15

Model	Region	Processor	2nd CPU	Memory	RAID Controller	Disk Bays	Storage	Slots	Optical	Add-on NIC	TPM	System Mgmt	OS	Warranty	Power Supply	Ann Date (m/y)
70DE000BUX	US	1xE5-2650 v3 10C/2.3GHz/25MB/105W/DDR4-2133	4XG0F28855	1x16GB RDIMM DDR4-2133 ECC	720ix+1GB RAM (AnyRAID)	24x2.5" HS	Open	2xFH HL	None	None	TPM	TSM Premium	None	3-year	750Wx1 Platinum	12/14
70DE000CUX	US	2xE5-2620 v3 6C/2.4GHz/15MB/85W/1866MH	-	8x16GB RDIMM DDR4-2133 ECC	720ix+1GB RAM (AnyRAID)	24x2.5" HS	8x300GB HDD 10K 2.5" SAS6Gbs	2xFH HL+4xLP HL	None	None	TPM	TSM Premium	None	3-year	750Wx2 Platinum	12/14
70DE000HUX	US	1xE5-2609 v3 6C/1.9GHz/15MB/85W/DDR4-1600	4XG0F28859	1x4GB RDIMM DDR4-2133 ECC	720ix+1GB RAM (AnyRAID)	24x2.5" HS	Open	None	None	None	TPM	TSM	None	3-year	750Wx1 Platinum	12/14
70DE000JUX	US	1xE5-2620 v3 6C/2.4GHz/15MB/85W/DDR4-1866	4XG0F28858	1x8GB RDIMM DDR4-2133 ECC	720ix+1GB RAM (AnyRAID)	24x2.5" HS	Open	2xFH HL	None	None	TPM	TSM	None	3-year	750Wx1 Platinum	12/14
70DE000KUX	US	1xE5-2640 v3 8C/2.6GHz/20MB/90W/DDR4-1866	4XG0F28856	1x8GB RDIMM DDR4-2133 ECC	720ix+1GB RAM (AnyRAID)	24x2.5" HS	Open	2xFH HL	None	None	TPM	TSM	None	3-year	750Wx1 Platinum	12/14

Model	Region	Processor	2nd CPU	Memory	RAID Controller	Disk Bays	Storage	Slots	Optical	Add-on NIC	TPM	System Mgmt	OS	Warranty	Power Supply	Ann Date (m/y)
70DV0008UX	US	1xE5-2603 v3 6C/1.6GHz/15MB/85W/DDR4-1600	4XG0F28860	1x4GB RDIMM DDR4-2133 ECC	720ix+1GB RAM (AnyRAID)	16x2.5" HS	Open	None	None	None	TPM	TSM	None	3-year	750Wx1 Platinum	12/14
70DV0009UX	US	1xE5-2620 v3 6C/2.4GHz/15MB/85W/DDR4-1866	4XG0F28858	1x8GB RDIMM DDR4-2133 ECC	720ix+1GB RAM (AnyRAID)	16x2.5" HS	Open	2xFH HL	None	None	TPM	TSM	None	3-year	750Wx1 Platinum	12/14
70DV000AUX	US	1xE5-2640 v3 8C/2.6GHz/20MB/90W/DDR4-1866	4XG0F28856	1x8GB RDIMM DDR4-2133 ECC	720ix+1GB RAM (AnyRAID)	16x2.5" HS	Open	2xFH HL	None	None	TPM	TSM	None	3-year	750Wx1 Platinum	12/14

Model	Region	Processor	2nd CPU	Memory	RAID Controller	Disk Bays	Storage	Slots	Optical	Add-on NIC	TPM	System Mgmt	OS	Warranty	Power Supply	Ann Date (m/y)
70Q9001DUX	US	1xE5-2603 v4 6C/1.7GHz/15MB/85W/DDR4-1866	4XG0G89090	1x16GB RDIMM DDR4-2400 ECC	110i (PCIe)	8x2.5" HS	Open	2xFH HL	None	None	TPM	TSM	None	3-year	750Wx1 Platinum	03/16
70Q9001EUX	US	1xE5-2609 v4 8C/1.7GHz/20MB/85W/DDR4-1866	4XG0G89085	1x16GB RDIMM DDR4-2400 ECC	110i (PCIe)	8x2.5" HS	Open	2xFH HL	None	None	TPM	TSM	None	3-year	750Wx1 Platinum	03/16
70Q9001FUX	US	1xE5-2620 v4 8C/2.1GHz/20MB/85W/DDR4-2133	4XG0G89080	1x16GB RDIMM DDR4-2400 ECC	110i (PCIe)	8x2.5" HS	Open	2xFH HL	None	None	TPM	TSM	None	3-year	750Wx1 Platinum	03/16
70Q9001GUX	US	1xE5-2630 v4 10C/2.2GHz/20MB/85W/DDR4-2133	4XG0G89075	1x16GB RDIMM DDR4-2400 ECC	110i (PCIe)	8x2.5" HS	Open	2xFH HL	None	None	TPM	TSM	None	3-year	750Wx1 Platinum	03/16
70Q9001HUX	US	1xE5-2640 v4 10C/2.4GHz/25MB/90W/DDR4-2133	4XG0G89070	1x16GB RDIMM DDR4-2400 ECC	110i (PCIe)	8x2.5" HS	Open	2xFH HL	None	None	TPM	TSM	None	3-year	750Wx1 Platinum	03/16
70Q9001JUX	US	1xE5-2650 v4 12C/2.2GHz/30MB/105W/DDR4-2400	4XG0G89065	1x16GB RDIMM DDR4-2400 ECC	110i (PCIe)	8x2.5" HS	Open	2xFH HL	None	None	TPM	TSM	None	3-year	750Wx1 Platinum	03/16
70Q9001KUX	US	1xE5-2660 v4 14C/2GHz/35MB/105W/DDR4-2400	4XG0G89060	1x16GB RDIMM DDR4-2400 ECC	110i (PCIe)	8x2.5" HS	Open	2xFH HL	None	None	TPM	TSM	None	3-year	750Wx1 Platinum	03/16

Model	Region	Processor	2nd CPU	Memory	RAID Controller	Disk Bays	Storage	Slots	Optical	Add-on NIC	TPM	System Mgmt	OS	Warranty	Power Supply	Ann Date (m/y)
70QQ0013UX	US	1xE5-2603 v4 6C/1.7GHz/15MB/85W/DDR4-1866	4XG0G89090	1x16GB RDIMM DDR4-2400 ECC	110i (PCIe)	8x3.5" HS	Open	2xFH HL	None	None	TPM	TSM	None	3-year	750Wx1 Platinum	03/16
70QQ0014UX	US	1xE5-2609 v4 8C/1.7GHz/20MB/85W/DDR4-1866	4XG0G89085	1x16GB RDIMM DDR4-2400 ECC	110i (PCIe)	8x3.5" HS	Open	2xFH HL	None	None	TPM	TSM	None	3-year	750Wx1 Platinum	03/16
70QQ0015UX	US	1xE5-2620 v4 8C/2.1GHz/20MB/85W/DDR4-2133	4XG0G89080	1x16GB RDIMM DDR4-2400 ECC	110i (PCIe)	8x3.5" HS	Open	2xFH HL	None	None	TPM	TSM	None	3-year	750Wx1 Platinum	03/16
70QQ0016UX	US	1xE5-2630 v4 10C/2.2GHz/20MB/85W/DDR4-2133	4XG0G89075	1x16GB RDIMM DDR4-2400 ECC	110i (PCIe)	8x3.5" HS	Open	2xFH HL	None	None	TPM	TSM	None	3-year	750Wx1 Platinum	03/16
70QQ0017UX	US	1xE5-2640 v4 10C/2.4GHz/25MB/90W/DDR4-2133	4XG0G89070	1x16GB RDIMM DDR4-2400 ECC	110i (PCIe)	8x3.5" HS	Open	2xFH HL	None	None	TPM	TSM	None	3-year	750Wx1 Platinum	03/16
70QQ0018UX	US	1xE5-2650 v4 12C/2.2GHz/30MB/105W/DDR4-2400	4XG0G89065	1x16GB RDIMM DDR4-2400 ECC	110i (PCIe)	8x3.5" HS	Open	2xFH HL	None	None	TPM	TSM	None	3-year	750Wx1 Platinum	03/16
70QQ0019UX	US	1xE5-2660 v4 14C/2GHz/35MB/105W/DDR4-2400	4XG0G89060	1x16GB RDIMM DDR4-2400 ECC	110i (PCIe)	8x3.5" HS	Open	2xFH HL	None	None	TPM	TSM	None	3-year	750Wx1 Platinum	03/16
70QQ001AUX	US	1xE5-2630 v4 10C/2.2GHz/20MB/85W/DDR4-2133	4XG0G89075	4x16GB RDIMM DDR4-2400 ECC	110i (PCIe)	8x3.5" HS	4x1TB HDD 7.2K 3.5" SATA6Gbs	2xFH HL	None	None	TPM	TSM Premium	None	3-year	750Wx2 Platinum	03/16
70QQ001BUX	US	2xE5-2620 v4 8C/2.1GHz/20MB/85W/DDR4-2133	-	2x16GB RDIMM DDR4-2400 ECC	110i (PCIe)	8x3.5" HS	Open	2xFH HL+4xLP HL	None	None	TPM	TSM Premium	None	3-year	750Wx2 Platinum	03/16

Model	Region	Processor	2nd CPU	Memory	RAID Controller	Disk Bays	Storage	Slots	Optical	Add-on NIC	TPM	System Mgmt	OS	Warranty	Power Supply	Ann Date (m/y)
70QS0000UX	US	1xE5-2603 v4 6C/1.7GHz/15MB/85W/DDR4-1866	4XG0G89090	1x16GB RDIMM DDR4-2400 ECC	720ix+1GB Flash (AnyRAID)	24x2.5" HS	Open	2xFH HL	None	None	TPM	TSM	None	3-year	750Wx1 Platinum	03/16
70QS0001UX	US	1xE5-2609 v4 8C/1.7GHz/20MB/85W/DDR4-1866	4XG0G89085	1x16GB RDIMM DDR4-2400 ECC	720ix+1GB Flash (AnyRAID)	24x2.5" HS	Open	2xFH HL	None	None	TPM	TSM	None	3-year	750Wx1 Platinum	03/16
70QS0002UX	US	1xE5-2620 v4 8C/2.1GHz/20MB/85W/DDR4-2133	4XG0G89080	1x16GB RDIMM DDR4-2400 ECC	720ix+1GB Flash (AnyRAID)	24x2.5" HS	Open	2xFH HL	None	None	TPM	TSM	None	3-year	750Wx1 Platinum	03/16
70QS0003UX	US	1xE5-2630 v4 10C/2.2GHz/20MB/85W/DDR4-2133	4XG0G89075	1x16GB RDIMM DDR4-2400 ECC	720ix+1GB Flash (AnyRAID)	24x2.5" HS	Open	2xFH HL	None	None	TPM	TSM	None	3-year	750Wx1 Platinum	03/16
70QS0004UX	US	1xE5-2640 v4 10C/2.4GHz/25MB/90W/DDR4-2133	4XG0G89070	1x16GB RDIMM DDR4-2400 ECC	720ix+1GB Flash (AnyRAID)	24x2.5" HS	Open	2xFH HL	None	None	TPM	TSM	None	3-year	750Wx1 Platinum	03/16
70QS0005UX	US	1xE5-2650 v4 12C/2.2GHz/30MB/105W/DDR4-2400	4XG0G89065	1x16GB RDIMM DDR4-2400 ECC	720ix+1GB Flash (AnyRAID)	24x2.5" HS	Open	2xFH HL	None	None	TPM	TSM	None	3-year	750Wx1 Platinum	03/16
70QS0006UX	US	1xE5-2660 v4 14C/2GHz/35MB/105W/DDR4-2400	4XG0G89060	1x16GB RDIMM DDR4-2400 ECC	720ix+1GB Flash (AnyRAID)	24x2.5" HS	Open	2xFH HL	None	None	TPM	TSM	None	3-year	750Wx1 Platinum	03/16

Model	Region	Processor	2nd CPU	Memory	RAID Controller	Disk Bays	Storage	Slots	Optical	Add-on NIC	TPM	System Mgmt	OS	Warranty	Power Supply	Ann Date (m/y)
70QW0004UX	US	1xE5-2603 v4 6C/1.7GHz/15MB/85W/DDR4-1866	4XG0G89090	1x16GB RDIMM DDR4-2400 ECC	720ix+1GB Flash (AnyRAID)	16x2.5" HS	Open	2xFH HL	None	None	TPM	TSM	None	3-year	750Wx1 Platinum	03/16
70QW0005UX	US	1xE5-2609 v4 8C/1.7GHz/20MB/85W/DDR4-1866	4XG0G89085	1x16GB RDIMM DDR4-2400 ECC	720ix+1GB Flash (AnyRAID)	16x2.5" HS	Open	2xFH HL	None	None	TPM	TSM	None	3-year	750Wx1 Platinum	03/16
70QW0006UX	US	1xE5-2620 v4 8C/2.1GHz/20MB/85W/DDR4-2133	4XG0G89080	1x16GB RDIMM DDR4-2400 ECC	720ix+1GB Flash (AnyRAID)	16x2.5" HS	Open	2xFH HL	None	None	TPM	TSM	None	3-year	750Wx1 Platinum	03/16
70QW0007UX	US	1xE5-2630 v4 10C/2.2GHz/20MB/85W/DDR4-2133	4XG0G89075	1x16GB RDIMM DDR4-2400 ECC	720ix+1GB Flash (AnyRAID)	16x2.5" HS	Open	2xFH HL	None	None	TPM	TSM	None	3-year	750Wx1 Platinum	03/16
70QW0008UX	US	1xE5-2640 v4 10C/2.4GHz/25MB/90W/DDR4-2133	4XG0G89070	1x16GB RDIMM DDR4-2400 ECC	720ix+1GB Flash (AnyRAID)	16x2.5" HS	Open	2xFH HL	None	None	TPM	TSM	None	3-year	750Wx1 Platinum	03/16
70QW0009UX	US	1xE5-2650 v4 12C/2.2GHz/30MB/105W/DDR4-2400	4XG0G89065	1x16GB RDIMM DDR4-2400 ECC	720ix+1GB Flash (AnyRAID)	16x2.5" HS	Open	2xFH HL	None	None	TPM	TSM	None	3-year	750Wx1 Platinum	03/16
70QW000AUX	US	1xE5-2660 v4 14C/2GHz/35MB/105W/DDR4-2400	4XG0G89060	1x16GB RDIMM DDR4-2400 ECC	720ix+1GB Flash (AnyRAID)	16x2.5" HS	Open	2xFH HL	None	None	TPM	TSM	None	3-year	750Wx1 Platinum	03/16

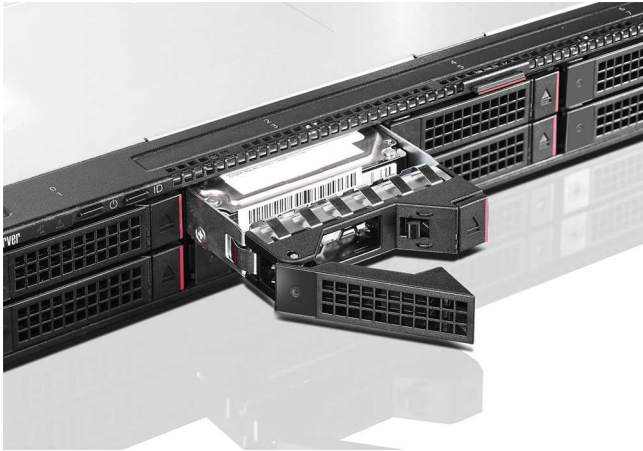

ThinkServer RD550 Platform Specifications

Product Specifications Reference (PSREF)

Components	Specification																								
Dimensions	1U rack. Height: 43 mm (1.7 in), width: 482 mm (19 in), depth: 780 mm (30.7 in)																								
Weight	Minimum configuration: 13.5 kg (29.76 lb), maximum: 21 kg (46.3 lb)																								
Processor	Up to two 145W Intel Xeon E5-2600 v3 family (code name: Haswell) processors with 18 cores up to 2.3GHz, 16 cores up to 2.3GHz, 14 cores up to 2.6GHz, 12 cores up to 2.6GHz, 10 cores up to 2.6GHz, 8 cores up to 3.2GHz, 6 cores up to 3.4GHz, 4 cores up to 3.5GHz. Two QPI link up to 9.6 GT/s. Up to 2133MHz memory speed. Up to 45MB cache																								
Chipset	Intel C612 Platform Controller Hub (PCH)																								
Memory DIMMs	24 DIMM sockets (12 DIMMs per processor), 8-channel capable (4-channel per processor). RDIMM and LRDIMM (cannot be intermixed), DDR4, up to 2133MHz																								
Memory capacity	384GB (RDIMM, 16GB x 24)/768GB (LRDIMM, 32GB x 24)																								
Memory protection	ECC, memory mirroring, lockstep, and memory sparing																								
AnyRAID support	RAID 0, 1, 10 with AnyRAID 110i. 6Gb/s SATA, optional key for RAID 5. RAID 0, 1, 10 with AnyRAID 510i. 6Gb/s SAS/SATA, optional key for RAID 5/50. RAID 0, 1, 10, 5, 50, 6, 60 with AnyRAID 720i/720ix. 12Gb/s SAS/SATA. 720i needs cache for RAID 6/60 support. 720ix must have cache. Optional cache for 720i/720ix: 1GB read-only memory. 1GB/2GB/4GB flash with super capacitor. Flash options include CacheVault, CacheCade Pro, and FastPath <i>Note: At least 6 disk drives is required for RAID 50 and 60.</i>																								
Disk drive bays	Up to 4 3.5" or 12 2.5" hot-swap disk bays on front. Up to 2 of 12 2.5" bays can support easy-swap PCIe SSD via optional Anybay kit (consumes one PCIe slot). Up to 2 2.5" rear mounted hot-swap disk bays on 3.5" models, optional. Up to 2 M.2 SSD drives via optional M.2 module. Supports external RDX tape drive via USB. <table border="1"> <thead> <tr> <th rowspan="2">Disk bay configuration</th> <th colspan="4">AnyRAID requirements and optional drives supported</th> </tr> <tr> <th>RAID110i</th> <th>RAID510i</th> <th>RAID720i</th> <th>RAID720ix</th> </tr> </thead> <tbody> <tr> <td>4x3.5"</td> <td>• (optional rear bay/M.2)</td> <td>• (optional rear bay/M.2)</td> <td>• (optional rear bay/M.2)</td> <td></td> </tr> <tr> <td>8x2.5"</td> <td>•</td> <td>•</td> <td>•</td> <td></td> </tr> <tr> <td>12x2.5"</td> <td></td> <td></td> <td></td> <td>• (optional Anybay/M.2)</td> </tr> </tbody> </table> <i>Note: 1. Rear disk drive and M.2 SSD can not be supported simultaneously. Only one can be selected per system. 2. On AnyRAID 110i and 8x2.5" model, 6 of 8 drives can be configured as RAID</i>	Disk bay configuration	AnyRAID requirements and optional drives supported				RAID110i	RAID510i	RAID720i	RAID720ix	4x3.5"	• (optional rear bay/M.2)	• (optional rear bay/M.2)	• (optional rear bay/M.2)		8x2.5"	•	•	•		12x2.5"				• (optional Anybay/M.2)
Disk bay configuration	AnyRAID requirements and optional drives supported																								
	RAID110i	RAID510i	RAID720i	RAID720ix																					
4x3.5"	• (optional rear bay/M.2)	• (optional rear bay/M.2)	• (optional rear bay/M.2)																						
8x2.5"	•	•	•																						
12x2.5"				• (optional Anybay/M.2)																					
Internal disk drive	3.5" HDD up to 8TB (SATA/SAS). 2.5" HDD up to 1.8TB (SAS)/2TB (SATA). 2.5" SSD up to 1.6TB (SATA/SAS). Easy-swap PCIe SSD up to 1.6TB. M.2 SSD up to 120GB. 2.5" SSD and HDD are compatible with 3.5" bay																								
SD module	Up to 2 SDHC flash cards via optional SD module, 8GB or 32GB each																								
Optical drive	Optional one 9.5mm optical drive on 3.5" model. DVD-ROM or DVD±RW																								
Network interfaces	One dedicated management port. One (3.5" model) or two (2.5" model) AnyFabric slots for customized LOM. Optional discrete network adapters via PCIe slots																								
Security features	Power-on and administrator password. Optional TPM (TCG 1.2-compliant)																								
Systems management	Supports ThinkServer System Manager (TSM), optional TSM Premium. UEFI. Onboard Aspeed AST2400 graphics/management processor, IPMI 2.0-compliant baseboard management controller (BMC). Control Panel LEDs shows the status of power, ID, network, system. Supports ThinkServer management software: Diagnostics, Deployment Manager, Energy Manager, System Manager, Partner Pack for VMware vCenter and Microsoft System Center Operations Manager, Power Planner																								

Components	Specification															
Operating systems supported	Microsoft Windows Server 2016/2012 R2/2012/2008 R2. Windows Small Business Server 2011. Red Hat Enterprise Linux 6.5/6.6/7. SUSE Linux Enterprise Server 11. VMware vSphere (ESXi) 5.1 P5/5.5 U2/6.0															
Base warranty	3-year limited onsite service with 9x5/NBD. Some parts are Customer Replaceable Units															
Power supply	Up to two redundant hot-swap 550W/750W/1100W power supplies. 550W and 1100W are 80 PLUS Platinum qualified. 750W is 80 PLUS Platinum or Titanium qualified. <table border="1"> <thead> <tr> <th rowspan="2">Disk bay configuration</th> <th colspan="3">PSU requirements</th> </tr> <tr> <th>550W</th> <th>750W</th> <th>1100W</th> </tr> </thead> <tbody> <tr> <td>4x3.5"</td> <td>•</td> <td>•</td> <td>•</td> </tr> <tr> <td>12x2.5"</td> <td>•</td> <td>•</td> <td>•</td> </tr> </tbody> </table> <i>Note: 750W Titanium is 200V - 240V, others are 110V - 240V.</i>	Disk bay configuration	PSU requirements			550W	750W	1100W	4x3.5"	•	•	•	12x2.5"	•	•	•
Disk bay configuration	PSU requirements															
	550W	750W	1100W													
4x3.5"	•	•	•													
12x2.5"	•	•	•													
Graphics	Onboard Aspeed AST2400 with 16MB memory, one DisplayPort on front, one DisplayPort on rear. Maximum resolution: 1920x1200@60Hz															
Front ports	(Only 3.5" model) Two USB 2.0, one DisplayPort															
Rear ports	One DisplayPort, two USB 3.0, one RJ-45 (dedicate mgmt), one serial (9-pin)															
Cooling	8 (7+1, dual processors) or 6 (5+1, single processor), hot-swap															
Noise emissions	Operating: < 6.5 Bels. Idle: < 6 Bels (Maximum configuration)															
Environmental specification	<table border="1"> <tbody> <tr> <td>Temperature - operating</td> <td>41 °F to 113 °F (5 °C to 45 °C)</td> </tr> <tr> <td>Temperature - non operating (no package)</td> <td>-10 °C to 60 °C</td> </tr> <tr> <td>Temperature - non operating (with package)</td> <td>-40 °C to 60 °C</td> </tr> <tr> <td>Altitude - operating</td> <td>(Unpressurized): 0-10000ft (0-3048m)</td> </tr> <tr> <td>Humidity - operating</td> <td>8%-90%, non-condensing</td> </tr> <tr> <td>Humidity - storage (with package)</td> <td>8%-90%, non-condensing</td> </tr> </tbody> </table> <i>Note: 45 °C continuous operation configuration limitation: no 145W CPU/no 135W 4, 6, or 8 cores CPU/no GPU card/redundant PSU/no FLFH card/no PCIe SSD adapter/no 1100W PSU.</i>	Temperature - operating	41 °F to 113 °F (5 °C to 45 °C)	Temperature - non operating (no package)	-10 °C to 60 °C	Temperature - non operating (with package)	-40 °C to 60 °C	Altitude - operating	(Unpressurized): 0-10000ft (0-3048m)	Humidity - operating	8%-90%, non-condensing	Humidity - storage (with package)	8%-90%, non-condensing			
Temperature - operating	41 °F to 113 °F (5 °C to 45 °C)															
Temperature - non operating (no package)	-10 °C to 60 °C															
Temperature - non operating (with package)	-40 °C to 60 °C															
Altitude - operating	(Unpressurized): 0-10000ft (0-3048m)															
Humidity - operating	8%-90%, non-condensing															
Humidity - storage (with package)	8%-90%, non-condensing															

Expansion slots

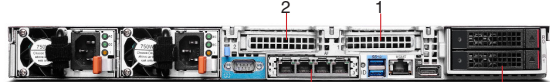
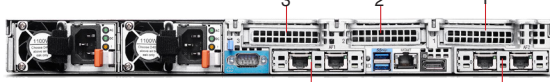
3.5" model	 <p>AnyFabric slot 1 (Network adapter is optional) Optional 2 x 2.5" rear bays</p>
Slot 1 (riser card 1)	PCIe 3.0 x 16, low-profile, half length
Slot 2 (riser card 2)	PCIe 3.0 x 16, low-profile, half length, requires 2nd riser card and 2nd CPU
2.5" model	 <p>AnyFabric slot 1 (Network adapter is optional) AnyFabric slot 2 (Network adapter is optional)</p>
Slot 1 (riser card 1)	PCIe 3.0 x 16 (x8 wired), low-profile, half length
Slot 2 (riser card 1)	PCIe 3.0 x 16 (x8 wired), low-profile, half length
Slot 3 (riser card 2)	PCIe 3.0 x 16, low-profile, half length, requires 2nd riser card and 2nd CPU

Model	Region	Processor	2nd CPU	Memory	RAID Controller	Disk Bays	Storage	Slots	Optical	Add-on NIC	TPM	System Mgmt	OS	Warranty	Power Supply	Ann Date (m/y)
70CV001CUX	US	1xXeon E5-2609 v3 6C/1.9GHz/15MB/85W/DDR4-1600	4XG0F28803	1x8GB RDIMM DDR4-2133 ECC	AnyRAID 110i	4x3.5" HS	Open	1xLP HL	9.5mm DVD±RW	None	TPM	TSM	None	3-year	750Wx1 Platinum	09/14
70CV001DUX	US	1xXeon E5-2620 v3 6C/2.4GHz/15MB/85W/DDR4-1866	4XG0F28802	1x8GB RDIMM DDR4-2133 ECC	AnyRAID 110i	4x3.5" HS	Open	1xLP HL	9.5mm DVD±RW	None	TPM	TSM	None	3-year	750Wx1 Platinum	09/14
70CV001EUX	US	1xXeon E5-2640 v3 8C/2.6GHz/20MB/90W/DDR4-1866	4XG0F28800	1x8GB RDIMM DDR4-2133 ECC	AnyRAID 510i	4x3.5" HS	Open	1xLP HL	9.5mm DVD±RW	None	TPM	TSM	None	3-year	750Wx1 Platinum	09/14
70CV001FUX	US	1xXeon E5-2650 v3 10C/2.3GHz/25MB/105W/DDR4-2133	4XG0F28799	1x8GB RDIMM DDR4-2133 ECC	AnyRAID 510i	4x3.5" HS	Open	1xLP HL	9.5mm DVD±RW	None	TPM	TSM	None	3-year	750Wx1 Platinum	09/14
70CV001GUX	US	1xXeon E5-2670 v3 12C/2.3GHz/30MB/120W/DDR4-2133	4XG0F28797	1x8GB RDIMM DDR4-2133 ECC	AnyRAID 720i+1GB RAM	4x3.5" HS	Open	1xLP HL	9.5mm DVD±RW	None	TPM	TSM	None	3-year	750Wx1 Platinum	09/14
70CV001JUX	US	1xXeon E5-2609 v3 6C/1.9GHz/15MB/85W/DDR4-1600	4XG0F28803	1x8GB RDIMM DDR4-2133 ECC	AnyRAID 510i	4x3.5" HS	Open	1xLP HL	9.5mm DVD±RW	None	TPM	TSM	None	3-year	750Wx1 Platinum	10/14
70CV001KUX	US	1xXeon E5-2620 v3 6C/2.4GHz/15MB/85W/DDR4-1866	4XG0F28802	1x8GB RDIMM DDR4-2133 ECC	AnyRAID 510i	4x3.5" HS	Open	1xLP HL	9.5mm DVD±RW	None	TPM	TSM	None	3-year	750Wx1 Platinum	10/14
70CV001LUX	US	1xXeon E5-2630 v3 8C/2.4GHz/20MB/85W/DDR4-1866	4XG0F28801	1x8GB RDIMM DDR4-2133 ECC	AnyRAID 510i	4x3.5" HS	Open	1xLP HL	9.5mm DVD±RW	None	TPM	TSM	None	3-year	750Wx1 Platinum	10/14
70CV001MUX	US	2xXeon E5-2630 v3 8C/2.4GHz/20MB/85W/DDR4-1866	-	2x8GB RDIMM DDR4-2133 ECC	AnyRAID 510i	4x3.5" HS	Open	2xLP HL	9.5mm DVD±RW	None	TPM	TSM	None	3-year	750Wx1 Platinum	10/14
70CV001NUX	US	1xXeon E5-2603 v3 6C/1.6GHz/15MB/85W/DDR4-1600	4XG0F28804	1x8GB RDIMM DDR4-2133 ECC	AnyRAID 110i	4x3.5" HS	Open	No	None	None	TPM	TSM	None	3-year	550Wx1 Platinum	10/14
70CV001SUX	US	1xXeon E5-2630 v3 8C/2.4GHz/20MB/85W/DDR4-1866	4XG0F28801	2x8GB RDIMM DDR4-2133 ECC	AnyRAID 110i	4x3.5" HS	2x1TB HDD 7.2K 3.5" SATA6Gbs	1xLP HL	9.5mm DVD±RW	GbEx4 RJ-45 AnyFabric	TPM	TSM Premium	None	3-year	750Wx2 Platinum	02/15
70CV001TUX	US	2xXeon E5-2620 v3 6C/2.4GHz/15MB/85W/DDR4-1866	-	2x16GB RDIMM DDR4-2133 ECC	AnyRAID 110i	4x3.5" HS	Open	2xLP HL	9.5mm DVD±RW	GbEx4 RJ-45 AnyFabric	TPM	TSM Premium	None	3-year	750Wx2 Platinum	09/15

Model	Region	Processor	2nd CPU	Memory	RAID Controller	Disk Bays	Storage	Slots	Optical	Add-on NIC	TPM	System Mgmt	OS	Warranty	Power Supply	Ann Date (m/y)
70CX001XUX	US	1xXeon E5-2620 v3 6C/2.4GHz/15MB/85W/DDR4-1866	4XG0F28802	1x8GB RDIMM DDR4-2133 ECC	AnyRAID 510i+Key	8x2.5" HS	Open	2xLP HL	None	None	TPM	TSM	None	3-year	750Wx1 Platinum	09/14
70CX001YUX	US	1xXeon E5-2640 v3 8C/2.6GHz/20MB/90W/DDR4-1866	4XG0F28800	1x8GB RDIMM DDR4-2133 ECC	AnyRAID 510i+Key	8x2.5" HS	Open	2xLP HL	None	None	TPM	TSM	None	3-year	750Wx1 Platinum	09/14
70CX0020UX	US	1xXeon E5-2650 v3 10C/2.3GHz/25MB/105W/DDR4-2133	4XG0F28799	1x8GB RDIMM DDR4-2133 ECC	AnyRAID 720ix+1GB RAM	12x2.5" HS	Open	2xLP HL	None	None	TPM	TSM	None	3-year	750Wx1 Platinum	09/14
70CX0021UX	US	1xXeon E5-2670 v3 12C/2.3GHz/30MB/120W/DDR4-2133	4XG0F28797	1x8GB RDIMM DDR4-2133 ECC	AnyRAID 720ix+1GB RAM	12x2.5" HS	Open	2xLP HL	None	None	TPM	TSM	None	3-year	750Wx1 Platinum	09/14
70CX0023UX	US	1xXeon E5-2620 v3 6C/2.4GHz/15MB/85W/DDR4-1866	4XG0F28802	1x8GB RDIMM DDR4-2133 ECC	AnyRAID 720ix+1GB RAM	12x2.5" HS	Open	2xLP HL	None	None	TPM	TSM	None	3-year	750Wx1 Platinum	10/14
70CX0024UX	US	1xXeon E5-2630 v3 8C/2.4GHz/20MB/85W/DDR4-1866	4XG0F28801	1x8GB RDIMM DDR4-2133 ECC	AnyRAID 720ix+1GB RAM	12x2.5" HS	Open	2xLP HL	None	None	TPM	TSM	None	3-year	750Wx1 Platinum	10/14
70CX0025UX	US	1xXeon E5-2630 v3 8C/2.4GHz/20MB/85W/DDR4-1866	4XG0F28801	1x8GB RDIMM DDR4-2133 ECC	AnyRAID 510i	8x2.5" HS	Open	2xLP HL	None	None	TPM	TSM	None	3-year	750Wx1 Platinum	10/14
70CX0027UX	US	1xXeon E5-2603 v3 6C/1.6GHz/15MB/85W/DDR4-1600	4XG0F28804	1x8GB RDIMM DDR4-2133 ECC	AnyRAID 110i	8x2.5" HS	Open	No	None	None	TPM	TSM	None	3-year	750Wx1 Platinum	10/14
70CX002VUX	US	1xXeon E5-2620 v3 6C/2.4GHz/15MB/85W/DDR4-1866	4XG0F28802	2x16GB RDIMM DDR4-2133 ECC	AnyRAID 510i+Key	8x2.5" HS	2x300GB HDD 15K 2.5" SAS12Gbs	No	None	GbEx4 RJ-45 AnyFabric	TPM	TSM Premium	None	3-year	750Wx2 Platinum	02/16

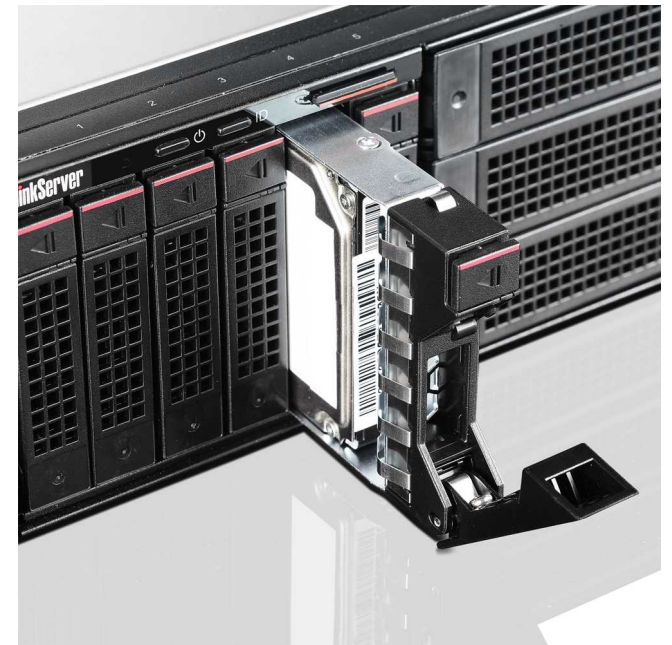

ThinkServer RD650 Platform Specifications

Product Specifications Reference (PSREF)

Components	Specification																																							
Dimensions	2U rack. Height: 87 mm (3.4 in), width: 482 mm (19 in), depth: 764 mm (30 in)																																							
Weight	Minimum configuration: 16 kg (35.3 lb), maximum: 32 kg (70.5 lb)																																							
Processor	Up to two 145W Intel Xeon E5-2600 v3 family (code name: Haswell) processors with 18 cores up to 2.3GHz, 16 cores up to 2.3GHz, 14 cores up to 2.6GHz, 12 cores up to 2.6GHz, 10 cores up to 2.6GHz, 8 cores up to 3.2GHz, 6 cores up to 3.4GHz, 4 cores up to 3.5GHz. Two QPI link up to 9.6 GT/s. Up to 2133MHz memory speed. Up to 45MB cache																																							
Chipset	Intel C612 Platform Controller Hub (PCH)																																							
Memory DIMMs	24 DIMM sockets (12 DIMMs per processor), 8-channel capable (4-channel per processor). RDIMM and LRDIMM (cannot be intermixed), DDR4, 2133MHz																																							
Memory capacity	384GB (RDIMM, 16GB x 24)/768GB (LRDIMM, 32GB x 24)																																							
Memory protection	ECC, memory mirroring, lockstep, and memory sparing																																							
AnyRAID support	RAID 0, 1, 10 with AnyRAID 110i. 6Gb/s SATA, optional key for RAID 5. RAID 0, 1, 10 with AnyRAID 510i. 6Gb/s SAS/SATA, optional key for RAID 5/50. RAID 0, 1, 10, 5, 50, 6, 60 with AnyRAID 720i/720ix. 12Gb/s SAS/SATA. 720i needs cache for RAID 6/60 support. 720ix must have cache. Optional cache for 720i/720ix: 1GB read-only memory. 1GB/2GB/4GB flash with super capacitor. Flash options include CacheVault, CacheCade Pro, and FastPath																																							
Disk drive bays	Up to 12 3.5", 24 2.5", or 6 2.5" plus 9 3.5" hot-swap disk bays on front. Up to 4 2.5" bays on 24 2.5" or 2.5" + 3.5" models can support easy-swap PCIe SSD via optional Anybay kit (consumes two PCIe slots). Up to 2 2.5" rear mounted hot-swap disk bays, optional. Up to 2 M.2 SSD drives via optional M.2 module. Up to one internal LTO-6 SAS tape drive on 8 x 2.5" and 720ix model, or external RDX tape drive via USB.																																							
	<table border="1"> <thead> <tr> <th rowspan="2">Disk bay configuration</th> <th colspan="4">AnyRAID requirements and optional drives supported</th> </tr> <tr> <th>RAID110i</th> <th>RAID510i</th> <th>RAID720i</th> <th>RAID720ix</th> </tr> </thead> <tbody> <tr> <td>6x3.5"</td> <td>•</td> <td>•</td> <td>•</td> <td></td> </tr> <tr> <td>12x3.5"</td> <td></td> <td></td> <td></td> <td>• (optional rear bay/M.2)</td> </tr> <tr> <td>8x2.5"</td> <td></td> <td>•</td> <td>•</td> <td>• (optional tape/rear bay/M.2)</td> </tr> <tr> <td>16x2.5"</td> <td></td> <td></td> <td></td> <td>• (optional rear bay/M.2)</td> </tr> <tr> <td>24x2.5"</td> <td></td> <td></td> <td></td> <td>• (optional Anybay/rear bay/M.2)</td> </tr> <tr> <td>6x2.5"+9x3.5"</td> <td></td> <td></td> <td></td> <td>• (optional Anybay/rear bay/M.2)</td> </tr> </tbody> </table>	Disk bay configuration	AnyRAID requirements and optional drives supported				RAID110i	RAID510i	RAID720i	RAID720ix	6x3.5"	•	•	•		12x3.5"				• (optional rear bay/M.2)	8x2.5"		•	•	• (optional tape/rear bay/M.2)	16x2.5"				• (optional rear bay/M.2)	24x2.5"				• (optional Anybay/rear bay/M.2)	6x2.5"+9x3.5"				• (optional Anybay/rear bay/M.2)
Disk bay configuration	AnyRAID requirements and optional drives supported																																							
	RAID110i	RAID510i	RAID720i	RAID720ix																																				
6x3.5"	•	•	•																																					
12x3.5"				• (optional rear bay/M.2)																																				
8x2.5"		•	•	• (optional tape/rear bay/M.2)																																				
16x2.5"				• (optional rear bay/M.2)																																				
24x2.5"				• (optional Anybay/rear bay/M.2)																																				
6x2.5"+9x3.5"				• (optional Anybay/rear bay/M.2)																																				
Internal disk drive	3.5" HDD up to 8TB (SATA/SAS). 2.5" HDD up to 1.8TB (SAS)/2TB (SATA). 2.5" SSD up to 1.6TB (SATA/SAS). Easy-swap PCIe SSD up to 1.6TB. PCIe SSD adapter up to 3.2TB. M.2 SSD up to 120GB. 2.5" SSD and HDD are compatible with 3.5" bay																																							
SD module	Up to 2 SDHC flash cards via optional SD module, 8GB or 32GB each																																							
Optical drive	Optional one 9.5mm optical drive on 8 or 16 x 2.5" model, DVD-ROM or DVD±RW																																							
Network interfaces	One dedicated management port, one AnyFabric slot for customized LOM. Discrete network options is also available via PCIe slots																																							
Security features	Power-on and administrator password. Optional TPM (TCG 1.2-compliant) Supports ThinkServer System Manager (TSM), optional TSM Premium. UEFI. Onboard Aspeed AST2400 graphics/management processor, IPMI 2.0-compliant baseboard management controller (BMC). Control Panel LEDs shows the status of power, ID, network, system. Supports ThinkServer management software: Diagnostics, Deployment Manager, Energy Manager, System Manager, Partner Pack for VMware vCenter and Microsoft System Center Operations Manager, Power Planner																																							

Components	Specification																																							
Operating systems supported	Microsoft Windows Server 2016/2012 R2/2012/2008 R2. Windows Small Business Server 2011. Red Hat Enterprise Linux 6.5/6.6/7. SUSE Linux Enterprise Server 11. VMware vSphere (ESXi) 5.1 P5/5.5 U2/6.0																																							
Base warranty	3-year limited onsite service with 9x5/NBD.																																							
Power supply	Up to two redundant hot-swap 550W/750W/1100W/1600W power supplies. 550W, 1100W, and 1600W are 80 PLUS Platinum qualified. 750W is 80 PLUS Platinum or Titanium qualified.																																							
	<table border="1"> <thead> <tr> <th rowspan="2">Disk bay configuration</th> <th colspan="4">PSU requirements</th> </tr> <tr> <th>550W</th> <th>750W</th> <th>1100W</th> <th>1600W</th> </tr> </thead> <tbody> <tr> <td>6x3.5"</td> <td>•</td> <td>•</td> <td>•</td> <td>•</td> </tr> <tr> <td>12x3.5"</td> <td colspan="4">• (up to 135W CPU)</td> </tr> <tr> <td>8x2.5"</td> <td>•</td> <td>•</td> <td>•</td> <td>•</td> </tr> <tr> <td>16x2.5"</td> <td colspan="4">• (up to 105W CPU+24 DIMMs or 135W+16 DIMMs)</td> </tr> <tr> <td>24x2.5"</td> <td>•</td> <td>•</td> <td>•</td> <td>•</td> </tr> <tr> <td>2.5"+3.5"</td> <td>•</td> <td>•</td> <td>•</td> <td>•</td> </tr> </tbody> </table> <p>Note: 1. 750W Titanium is 200V - 240V, others are 110V - 240V. 2. 1600W will automatically operate in 1100W if the system line input is 100-127V.</p>	Disk bay configuration	PSU requirements				550W	750W	1100W	1600W	6x3.5"	•	•	•	•	12x3.5"	• (up to 135W CPU)				8x2.5"	•	•	•	•	16x2.5"	• (up to 105W CPU+24 DIMMs or 135W+16 DIMMs)				24x2.5"	•	•	•	•	2.5"+3.5"	•	•	•	•
Disk bay configuration	PSU requirements																																							
	550W	750W	1100W	1600W																																				
6x3.5"	•	•	•	•																																				
12x3.5"	• (up to 135W CPU)																																							
8x2.5"	•	•	•	•																																				
16x2.5"	• (up to 105W CPU+24 DIMMs or 135W+16 DIMMs)																																							
24x2.5"	•	•	•	•																																				
2.5"+3.5"	•	•	•	•																																				
Graphics	Onboard Aspeed AST2400 with 16MB memory, one DisplayPort on rear																																							
Front ports	(Only 2.5" bay models) Two USB 2.0, one DisplayPort																																							
Rear ports	One DisplayPort, two USB 3.0, one RJ-45 (dedicate mgmt), one serial (9-pin)																																							
Cooling	Six (5+1, dual processors) or four (3+1, single processor), hot-swap																																							
Noise emissions	Operating: < 6.5 Bels. Idle: < 6 Bels (Maximum configuration)																																							
Environmental specification	<table border="1"> <tbody> <tr> <td>Temperature - operating</td> <td>41 °F to 113 °F (5 °C to 45 °C)</td> </tr> <tr> <td>Temperature - non operating (no package)</td> <td>-10 °C to 60 °C</td> </tr> <tr> <td>Temperature - non operating (with package)</td> <td>-40 °C to 60 °C</td> </tr> <tr> <td>Altitude - operating</td> <td>(Unpressurized): 0-10000ft (0-3048m)</td> </tr> <tr> <td>Humidity - operating</td> <td>8%-90%, non-condensing</td> </tr> <tr> <td>Humidity - storage (with package)</td> <td>8%-90%, non-condensing</td> </tr> </tbody> </table> <p>Note: 45 °C continuous operation configuration limitation: no 135W or 145W CPU/no GPU card/redundant PSU/no FLFH card/no PCIe SSD adapter.</p>	Temperature - operating	41 °F to 113 °F (5 °C to 45 °C)	Temperature - non operating (no package)	-10 °C to 60 °C	Temperature - non operating (with package)	-40 °C to 60 °C	Altitude - operating	(Unpressurized): 0-10000ft (0-3048m)	Humidity - operating	8%-90%, non-condensing	Humidity - storage (with package)	8%-90%, non-condensing																											
Temperature - operating	41 °F to 113 °F (5 °C to 45 °C)																																							
Temperature - non operating (no package)	-10 °C to 60 °C																																							
Temperature - non operating (with package)	-40 °C to 60 °C																																							
Altitude - operating	(Unpressurized): 0-10000ft (0-3048m)																																							
Humidity - operating	8%-90%, non-condensing																																							
Humidity - storage (with package)	8%-90%, non-condensing																																							

Expansion slots

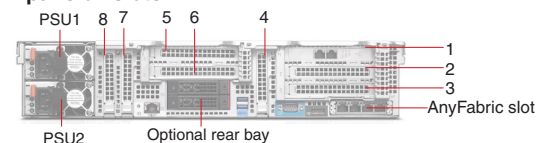

Slot 1 (riser card 1)	PCIe 3.0 x 16, half length, full height
Slot 2 (riser card 1)	PCIe 3.0 x 16, half length, full height
Slot 3 (riser card 1)	PCIe 3.0 x 16, half length, full height
Slot 4 (onboard)	PCIe 3.0 x 16, low-profile, half length, requires 2nd CPU
Slot 5 (riser card 2)	PCIe 3.0 x 16, half length, full height, requires 2nd riser card and 2nd CPU
Slot 6 (riser card 2)	PCIe 3.0 x 16, half length, full height, requires 2nd riser card and 2nd CPU
Slot 7 (onboard)	PCIe 3.0 x 16, low-profile, half length, requires 2nd CPU
Slot 8 (onboard)	PCIe 3.0 x 16, low-profile, half length, requires 2nd CPU

Notes:
On 2.5" disk bay models, slots 1 and 2 can be replaced with one PCIe 3.0 x 16 slot, double wide, full length, full height. Slots 5 and 6 can be replaced with one PCIe 3.0 x 16 slot, double wide, full length, full height.

Model	Region	Processor	2nd CPU	Memory	RAID Controller	Disk Bays	Storage	Slots	Optical	Add-on NIC	TPM	System Mgmt	OS	Warranty	Power Supply	Ann Date (m/y)
70D0000FUX	US	1xE5-2609 v3 6C/1.9GHz/15MB/85W/DDR4-1600	4XG0F28820	1x8GB RDIMM DDR4-2133 ECC	AnyRAID 720ix+1GB RAM	12x3.5" HS	Open	3xFH HL	None	None	TPM	TSM	None	3-year	1100Wx1 Platinum	09/14
70D0000GUX	US	1xE5-2620 v3 6C/2.4GHz/15MB/85W/DDR4-1866	4XG0F28819	1x8GB RDIMM DDR4-2133 ECC	AnyRAID 720ix+1GB RAM	12x3.5" HS	Open	3xFH HL	None	None	TPM	TSM	None	3-year	1100Wx1 Platinum	09/14
70D0000HUX	US	1xE5-2640 v3 8C/2.6GHz/20MB/90W/DDR4-1866	4XG0F28817	1x8GB RDIMM DDR4-2133 ECC	AnyRAID 720ix+1GB RAM	12x3.5" HS	Open	3xFH HL	None	None	TPM	TSM	None	3-year	1100Wx1 Platinum	09/14
70D0000JUX	US	1xE5-2650 v3 10C/2.3GHz/25MB/105W/DDR4-2133	4XG0F28816	1x8GB RDIMM DDR4-2133 ECC	AnyRAID 720ix+1GB RAM	12x3.5" HS	Open	3xFH HL	None	None	TPM	TSM	None	3-year	1100Wx1 Platinum	09/14
70D0000KUX	US	1xE5-2690 v3 12C/2.6GHz/30MB/135W/DDR4-2133	4XG0F28811	1x8GB RDIMM DDR4-2133 ECC	AnyRAID 720ix+1GB RAM	12x3.5" HS	Open	3xFH HL	None	None	TPM	TSM	None	3-year	1100Wx1 Platinum	09/14
70D00025UX	US	1xE5-2630 v3 8C/2.4GHz/20MB/85W/DDR4-1866	4XG0F28818	1x8GB RDIMM DDR4-2133 ECC	AnyRAID 720ix+1GB RAM	12x3.5" HS	Open	3xFH HL	None	None	TPM	TSM	None	3-year	1100Wx1 Platinum	10/14
70D00026UX	US	1xE5-2603 v3 6C/1.6GHz/15MB/85W/DDR4-1600	4XG0F28821	1x8GB RDIMM DDR4-2133 ECC	AnyRAID 110i	6x3.5" HS	Open	No	None	None	TPM	TSM	None	3-year	550Wx1 Platinum	10/14
70D0002BUX	US	1xE5-2630 v3 8C/2.4GHz/20MB/85W/DDR4-1866	4XG0F28818	1x8GB RDIMM DDR4-2133 ECC	AnyRAID 720ix+1GB RAM	12x3.5" HS	Open	3xFH HL	None	None	TPM	TSM	None	3-year	750Wx1 Platinum	02/15

Model	Region	Processor	2nd CPU	Memory	RAID Controller	Disk Bays	Storage	Slots	Optical	Add-on NIC	TPM	System Mgmt	OS	Warranty	Power Supply	Ann Date (m/y)
70D20024UX	US	1xE5-2603 v3 6C/1.6GHz/15MB/85W/DDR4-1600	4XG0F28821	1x8GB RDIMM DDR4-2133 ECC	AnyRAID 720ix+1GB RAM	24x2.5" HS	Open	No	None	None	TPM	TSM	None	3-year	750Wx1 Platinum	10/14

Model	Region	Processor	2nd CPU	Memory	RAID Controller	Disk Bays	Storage	Slots	Optical	Add-on NIC	TPM	System Mgmt	OS	Warranty	Power Supply	Ann Date (m/y)
70D4000CUX	US	1xE5-2620 v3 6C/2.4GHz/15MB/85W/DDR4-1866	4XG0F28819	1x8GB RDIMM DDR4-2133 ECC	AnyRAID 720ix+1GB RAM	6+9 HS	Open	3xFH HL	None	None	TPM	TSM	None	3-year	1100Wx1 Platinum	09/14
70D4000DUX	US	1xE5-2640 v3 8C/2.6GHz/20MB/90W/DDR4-1866	4XG0F28817	1x8GB RDIMM DDR4-2133 ECC	AnyRAID 720ix+1GB RAM	6+9 HS	Open	3xFH HL	None	None	TPM	TSM	None	3-year	1100Wx1 Platinum	09/14
70D4000EUX	US	1xE5-2650 v3 10C/2.3GHz/25MB/105W/DDR4-2133	4XG0F28816	1x8GB RDIMM DDR4-2133 ECC	AnyRAID 720ix+1GB RAM	6+9 HS	Open	3xFH HL	None	None	TPM	TSM	None	3-year	1100Wx1 Platinum	09/14
70D4000FUX	US	1xE5-2690 v3 12C/2.6GHz/30MB/135W/DDR4-2133	4XG0F28811	1x8GB RDIMM DDR4-2133 ECC	AnyRAID 720ix+1GB RAM	6+9 HS	Open	3xFH HL	None	None	TPM	TSM	None	3-year	1100Wx1 Platinum	09/14
70D4001RUX	US	1xE5-2603 v3 6C/1.6GHz/15MB/85W/DDR4-1600	4XG0F28821	1x8GB RDIMM DDR4-2133 ECC	AnyRAID 720ix+1GB RAM	6+9 HS	Open	No	None	None	TPM	TSM	None	3-year	750Wx1 Platinum	10/14
70D4001UUX	US	1xE5-2650 v3 10C/2.3GHz/25MB/105W/DDR4-2133	4XG0F28816	1x8GB RDIMM DDR4-2133 ECC	AnyRAID 720ix+1GB RAM	6+9 HS	Open	3xFH HL	None	None	TPM	TSM	None	3-year	750Wx1 Platinum	02/15
70D40025UX	US	2xE5-2620 v3 6C/2.4GHz/15MB/85W/DDR4-1866	-	2x16GB RDIMM DDR4-2133 ECC	AnyRAID 720ix+1GB Flash	6+9 HS	Open	5xFH HL+3xLP HL	None	10GbEx2 RJ-45 AnyFabric	TPM	TSM Premium	None	3-year	750Wx2 Platinum	09/15
70D40026UX	US	2xE5-2690 v3 12C/2.6GHz/30MB/135W/DDR4-2133	-	8x16GB RDIMM DDR4-2133 ECC	AnyRAID 720ix+1GB RAM	6+9 HS	4x600GB HDD 10K 2.5" SAS12Gbs	3xLP HL	None	GbEx4 RJ-45 AnyFabric	TPM	TSM Premium	None	3-year	1100Wx2 Platinum	02/16
70D40027UX	US	1xE5-2650 v3 10C/2.3GHz/25MB/105W/DDR4-2133	4XG0F28816	4x16GB RDIMM DDR4-2133 ECC	AnyRAID 720ix+1GB RAM	6+9 HS	2x300GB HDD 15K 2.5" SAS12Gbs+2x2TB HDD 7.2K 3.5" SATA6Gbs	No	None	GbEx4 RJ-45 AnyFabric	TPM	TSM Premium	None	3-year	1100Wx2 Platinum	02/16
70D40028UX	US	2xE5-2650 v3 10C/2.3GHz/25MB/105W/DDR4-2133	-	8x16GB RDIMM DDR4-2133 ECC	AnyRAID 720ix+1GB RAM	6+9 HS (AnyBay)	2x120GB 2.5" SSD SATA6Gbs	3xFH HL+3xLP HL	None	GbEx4 RJ-45 AnyFabric	TPM	TSM Premium	None	3-year	750Wx2 Platinum	11/15
70D40029UX	US	2xE5-2690 v3 12C/2.6GHz/30MB/135W/DDR4-2133	-	8x16GB RDIMM DDR4-2133 ECC	AnyRAID 720ix+1GB RAM	6+9 HS (AnyBay)	2x120GB 2.5" SSD SATA6Gbs	3xFH HL+3xLP HL	None	GbEx4 RJ-45 AnyFabric	TPM	TSM Premium	None	3-year	750Wx2 Platinum	11/15

Model	Region	Processor	2nd CPU	Memory	RAID Controller	Disk Bays	Storage	Slots	Optical	Add-on NIC	TPM	System Mgmt	OS	Warranty	Power Supply	Ann Date (m/y)
70DR000QUX	US	1xE5-2609 v3 6C/1.9GHz/15MB/85W/DDR4-1600	4XG0F28820	1x8GB RDIMM DDR4-2133 ECC	AnyRAID 510i	8x2.5" HS	Open	3xFH HL	9.5mm DVD±RW	None	TPM	TSM	None	3-year	1100Wx1 Platinum	09/14
70DR000RUX	US	1xE5-2620 v3 6C/2.4GHz/15MB/85W/DDR4-1866	4XG0F28819	1x8GB RDIMM DDR4-2133 ECC	AnyRAID 510i	8x2.5" HS	Open	3xFH HL	9.5mm DVD±RW	None	TPM	TSM	None	3-year	1100Wx1 Platinum	09/14
70DR000SUX	US	1xE5-2640 v3 8C/2.6GHz/20MB/90W/DDR4-1866	4XG0F28817	1x8GB RDIMM DDR4-2133 ECC	AnyRAID 510i	8x2.5" HS	Open	3xFH HL	9.5mm DVD±RW	None	TPM	TSM	None	3-year	1100Wx1 Platinum	09/14
70DR000TUX	US	1xE5-2650 v3 10C/2.3GHz/25MB/105W/DDR4-2133	4XG0F28816	1x8GB RDIMM DDR4-2133 ECC	AnyRAID 510i	8x2.5" HS	Open	3xFH HL	9.5mm DVD±RW	None	TPM	TSM	None	3-year	1100Wx1 Platinum	09/14
70DR002KUX	US	1xE5-2630 v3 8C/2.4GHz/20MB/85W/DDR4-1866	4XG0F28818	1x8GB RDIMM DDR4-2133 ECC	AnyRAID 510i	8x2.5" HS	Open	3xFH HL	None	None	TPM	TSM	None	3-year	1100Wx1 Platinum	10/14
70DR002LUX	US	2xE5-2630 v3 8C/2.4GHz/20MB/85W/DDR4-1866	-	2x8GB RDIMM DDR4-2133 ECC	AnyRAID 510i	8x2.5" HS	Open	3xFH HL+3xLP HL	None	None	TPM	TSM	None	3-year	1100Wx1 Platinum	10/14
70DR002MUX	US	1xE5-2603 v3 6C/1.6GHz/15MB/85W/DDR4-1600	4XG0F28821	1x8GB RDIMM DDR4-2133 ECC	AnyRAID 510i	8x2.5" HS	Open	3xFH HL	None	None	TPM	TSM	None	3-year	750Wx1 Platinum	10/14
70DR002RUX	US	1xE5-2620 v3 6C/2.4GHz/15MB/85W/DDR4-1866	4XG0F28819	2x8GB RDIMM DDR4-2133 ECC	AnyRAID 720i+1GB RAM	8x2.5" HS	2x300GB HDD 10K 2.5" SAS6Gbs	3xFH HL	None	GbEx4 RJ-45 AnyFabric	TPM	TSM Premium	None	3-year	750Wx2 Platinum	02/15
70DR002SUX	US	1xE5-2620 v3 6C/2.4GHz/15MB/85W/DDR4-1866	4XG0F28819	1x8GB RDIMM DDR4-2133 ECC	AnyRAID 510i	8x2.5" HS	Open	3xFH HL	None	None	TPM	TSM	None	3-year	750Wx1 Platinum	02/15

Model	Region	Processor	2nd CPU	Memory	RAID Controller	Disk Bays	Storage	Slots	Optical	Add-on NIC	TPM	System Mgmt	OS	Warranty	Power Supply	Ann Date (m/y)
70DT000CUX	US	1xE5-2603 v3 6C/1.6GHz/15MB/85W/DDR4-1600	4XG0F28821	1x8GB RDIMM DDR4-2133 ECC	AnyRAID 720ix+1GB Flash	16x2.5" HS	Open	No	None	None	TPM	TSM	None	3-year	750Wx1 Platinum	10/14



ThinkServer RS140 Platform Specifications

Components	Specification															
Dimensions	1U rack. Height: 43.5 mm (1.71 in), width: 430 mm (16.9 in), depth: 411 mm (16.2 in)															
Weight	Maximum configuration: 16.2 lb (7.36kg)															
Processor	Supports one of the following Intel processors (code name: Haswell): <ul style="list-style-type: none"> Xeon E3-1200 v3: up to 4C/3.7GHz/8MB/84W/1600MHz Core i3: up to 2C/3.7GHz/4MB/54W/1600MHz Pentium: up to 2C/3.4GHz/3MB/53W/1600MHz Celeron: up to 2C/2.9GHz/2MB/53W/1333MHz <i>Note: Supports processors with integrated graphics only.</i>															
Chipset	Intel C226 Platform Controller Hub (PCH)															
Memory DIMMs	4 DIMM sockets, 2-channel capable. UDIMM, DDR3															
Memory capacity	32GB (4 x 8GB)															
Memory protection	ECC															
RAID controller	RAID 0, 1, 5, 10 with onboard RAID 100, 6Gb/s SATA. RAID 0, 1, 10 with RAID 500, PCIe adapter, 6Gb/s SAS/SATA, optional key for RAID5. RAID 0, 1, 10, 5, 6 with RAID 700, PCIe adapter, 6Gb/s SAS/SATA, optional Intelligent Battery Backup Unit (iBBU08) <i>Note: RAID 5, 6, and 10 needs 4 x 2.5" bays.</i>															
Disk drive bays	Up to 2 3.5" disk bays or up to 4 2.5" disk bays. Direct cabled, non-hot swap. Supports optional external USB RDX tape drive															
Supporting disk drives	<table border="1"> <thead> <tr> <th>For 3.5" bay</th> <th>3.5" SATA HDD</th> <th>7.2K 6Gbs: 500GB/1TB/2TB/3TB/4TB/6TB</th> </tr> </thead> <tbody> <tr> <td></td> <td>3.5" SAS HDD</td> <td>7.2K 6Gbs: 1TB/2TB/3TB/4TB</td> </tr> <tr> <th>For 2.5" bay</th> <th>2.5" SATA HDD</th> <th>7.2K 6Gbs: 500GB/1TB</th> </tr> <tr> <td></td> <td>2.5" SAS HDD</td> <td>10K 6Gbs: 300GB/600GB/900GB. 15K 6Gbs: 146GB/300GB</td> </tr> <tr> <td></td> <td>2.5" SATA SSD</td> <td>6Gbs: 120GB/240GB/300GB/480GB/600GB</td> </tr> </tbody> </table>	For 3.5" bay	3.5" SATA HDD	7.2K 6Gbs: 500GB/1TB/2TB/3TB/4TB/6TB		3.5" SAS HDD	7.2K 6Gbs: 1TB/2TB/3TB/4TB	For 2.5" bay	2.5" SATA HDD	7.2K 6Gbs: 500GB/1TB		2.5" SAS HDD	10K 6Gbs: 300GB/600GB/900GB. 15K 6Gbs: 146GB/300GB		2.5" SATA SSD	6Gbs: 120GB/240GB/300GB/480GB/600GB
For 3.5" bay	3.5" SATA HDD	7.2K 6Gbs: 500GB/1TB/2TB/3TB/4TB/6TB														
	3.5" SAS HDD	7.2K 6Gbs: 1TB/2TB/3TB/4TB														
For 2.5" bay	2.5" SATA HDD	7.2K 6Gbs: 500GB/1TB														
	2.5" SAS HDD	10K 6Gbs: 300GB/600GB/900GB. 15K 6Gbs: 146GB/300GB														
	2.5" SATA SSD	6Gbs: 120GB/240GB/300GB/480GB/600GB														
Optical drive	Up to one 9.5mm optical. DVD-ROM or DVD±RW															
Network interfaces	Two Gigabit Ethernet ports by Intel I210, on riser card. One Gigabit Ethernet port by Intel I217, dedicate/share management															
Security features	Power-on and administrator password. TPM (TCG 1.2-compliant).															
Systems management	Intel Active Management Technology 9 on models with Xeon processor. Remote presence is supported on models with Xeon processors. Supports ThinkServer EasyStartup/EasyUpdate															
Operating systems supported	Microsoft Windows Server 2016/2012 R2/2012/2008 R2. Windows Small Business Server 2011. Red Hat Enterprise Linux 6.5. SUSE Linux Enterprise Server 11 SP3. VMware vSphere (ESXi) 5.5 <i>Note: VMware requires add-on network adapter.</i>															

Components	Specification	
Base warranty	1 or 3-year limited onsite service with 9x5/NBD.	
Power supply	One fixed 300 watts power supply, 80 PLUS Gold qualified	
Graphics	Integrated Intel HD Graphics in processor	
Front ports	Two USB 2.0	
Rear ports	Four USB 3.0, two USB 2.0, one serial (9-pin), two ethernet (RJ-45), one RJ-45 (dedicate/share mgmt), one VGA, one DisplayPort. Optional two serial ports via PCIe adapter	
Noise emissions	Operating: < 5.2 Bels. Idle: < 5.0 Bels (Mainstream configuration)	
Environmental specification	RoHS-compliant.	
	Temperature - operating	50 °F to 95 °F (10 °C to 35 °C)
	Temperature - storage (with package)	-40 °C to 70 °C
	Altitude - operating	Supported Altitude (unpressurized): 0-10000ft (0-3048m)
	Humidity - operating	10%-80%, non-condensing
	Humidity - storage (with package)	10%-90%, non-condensing

Expansion slots and disk bays

Supports one PCI-Express slot via riser card, half-length, full-height, PCIe 3.0 x8

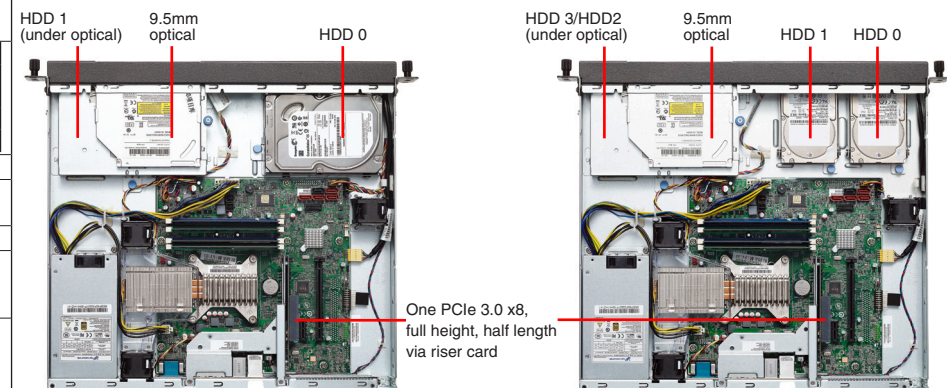

Model	Region	Processor	Memory	RAID Controller	Disk Bays	Storage	Optical	Add-on NIC	Add-on Ports	System Mgmt	OS	Warranty	Power Supply	Ann Date (m/y)
70F30006UX	US	Core i3-4130 2C/3.4GHz/3MB/54W/DDR3-1600	1x4GB UDIMM DDR3-1600 ECC	RAID 100	4x2.5" DC	Open	9.5mm DVD±RW	None	None	AMT9	None	1-year	300W Gold Fixed	06/14
70F30007UX	US	Xeon E3-1225 v3 4C/3.2GHz/8MB/84W/DDR3-1600	1x4GB UDIMM DDR3-1600 ECC	RAID 100	4x2.5" DC	Open	9.5mm DVD±RW	None	None	AMT9	None	1-year	300W Gold Fixed	06/14
70F30008UX	US	Xeon E3-1245 v3 4C/3.4GHz/8MB/84W/DDR3-1600	1x4GB UDIMM DDR3-1600 ECC	RAID 100	4x2.5" DC	Open	9.5mm DVD±RW	None	None	AMT9	None	1-year	300W Gold Fixed	06/14
70F30009UX	US	Xeon E3-1225 v3 4C/3.2GHz/8MB/84W/DDR3-1600	1x4GB UDIMM DDR3-1600 ECC	RAID 500	4x2.5" DC	Open	9.5mm DVD±RW	None	None	AMT9	None	1-year	300W Gold Fixed	06/14
70F3000AUX	US	Xeon E3-1245 v3 4C/3.4GHz/8MB/84W/DDR3-1600	1x4GB UDIMM DDR3-1600 ECC	RAID 500	4x2.5" DC	Open	9.5mm DVD±RW	None	None	AMT9	None	1-year	300W Gold Fixed	06/14
70F3000BUX	US	Xeon E3-1245 v3 4C/3.4GHz/8MB/84W/DDR3-1600	1x8GB UDIMM DDR3-1600 ECC	RAID 500+Key	4x2.5" DC	Open	9.5mm DVD±RW	None	None	AMT9	None	1-year	300W Gold Fixed	06/14
70F3000CUX	US	Xeon E3-1245 v3 4C/3.4GHz/8MB/84W/DDR3-1600	1x8GB UDIMM DDR3-1600 ECC	RAID 700	4x2.5" DC	Open	9.5mm DVD±RW	None	None	AMT9	None	1-year	300W Gold Fixed	06/14
70F3000DUS	US	Xeon E3-1225 v3 4C/3.2GHz/8MB/84W/DDR3-1600	2x4GB UDIMM DDR3-1600 ECC	RAID 500+Key	4x2.5" DC	2x500GB HDD 7.2K 2.5" SATA6Gbs	9.5mm DVD±RW	None	None	AMT9	2012 R2 Standard	1-year	300W Gold Fixed	06/14
70F3000EUS	US	Xeon E3-1245 v3 4C/3.4GHz/8MB/84W/DDR3-1600	2x8GB UDIMM DDR3-1600 ECC	RAID 700	4x2.5" DC	4x500GB HDD 7.2K 2.5" SATA6Gbs	9.5mm DVD±RW	None	None	AMT9	2012 R2 Standard	1-year	300W Gold Fixed	06/14
70F30017UX	US	Core i3-4150 2C/3.5GHz/3MB/54W/DDR3-1600	1x4GB UDIMM DDR3-1600 ECC	RAID 100	4x2.5" DC	Open	9.5mm DVD±RW	None	None	AMT9	None	1-year	300W Gold Fixed	09/14
70F30018UX	US	Xeon E3-1226 v3 4C/3.3GHz/8MB/84W/DDR3-1600	1x4GB UDIMM DDR3-1600 ECC	RAID 100	4x2.5" DC	Open	9.5mm DVD±RW	None	None	AMT9	None	1-year	300W Gold Fixed	09/14
70F30019UX	US	Xeon E3-1246 v3 4C/3.5GHz/8MB/84W/DDR3-1600	1x4GB UDIMM DDR3-1600 ECC	RAID 100	4x2.5" DC	Open	9.5mm DVD±RW	None	None	AMT9	None	1-year	300W Gold Fixed	09/14
70F3001AUX	US	Xeon E3-1226 v3 4C/3.3GHz/8MB/84W/DDR3-1600	1x4GB UDIMM DDR3-1600 ECC	RAID 500	4x2.5" DC	Open	9.5mm DVD±RW	None	None	AMT9	None	1-year	300W Gold Fixed	09/14
70F3001BUX	US	Xeon E3-1246 v3 4C/3.5GHz/8MB/84W/DDR3-1600	1x4GB UDIMM DDR3-1600 ECC	RAID 500	4x2.5" DC	Open	9.5mm DVD±RW	None	None	AMT9	None	1-year	300W Gold Fixed	09/14
70F3001EUS	US	Xeon E3-1226 v3 4C/3.3GHz/8MB/84W/DDR3-1600	1x4GB UDIMM DDR3-1600 ECC	RAID 100	4x2.5" DC	2x500GB HDD 7.2K 2.5" SATA6Gbs	9.5mm DVD±RW	None	None	AMT9	2012 R2 Foundations	1-year	300W Gold Fixed	09/14
70F3001FUS	US	Xeon E3-1226 v3 4C/3.3GHz/8MB/84W/DDR3-1600	1x4GB UDIMM DDR3-1600 ECC	RAID 100	4x2.5" DC	2x500GB HDD 7.2K 2.5" SATA6Gbs	9.5mm DVD±RW	None	None	AMT9	2012 R2 Essentials	1-year	300W Gold Fixed	09/14
70F3001GUS	US	Xeon E3-1226 v3 4C/3.3GHz/8MB/84W/DDR3-1600	1x4GB UDIMM DDR3-1600 ECC	RAID 100	4x2.5" DC	2x120GB SSD 2.5" SATA6Gbs	9.5mm DVD±RW	None	None	AMT9	2012 R2 Foundations	1-year	300W Gold Fixed	09/14

Model	Region	Processor	Memory	RAID Controller	Disk Bays	Storage	Optical	Add-on NIC	Add-on Ports	System Mgmt	OS	Warranty	Power Supply	Ann Date (m/y)
70F3001HUS	US	Xeon E3-1226 v3 4C/3.3GHz/8MB/84W/DDR3-1600	1x4GB UDIMM DDR3-1600 ECC	RAID 100	4x2.5" DC	2x120GB SSD 2.5" SATA6Gbs	9.5mm DVD±RW	None	None	AMT9	2012 R2 Essentials	1-year	300W Gold Fixed	09/14

Model	Region	Processor	Memory	RAID Controller	Disk Bays	Storage	Optical	Add-on NIC	Add-on Ports	System Mgmt	OS	Warranty	Power Supply	Ann Date (m/y)
70F90007UX	US	Core i3-4130 2C/3.4GHz/3MB/54W/DDR3-1600	1x4GB UDIMM DDR3-1600 ECC	RAID 100	2x3.5" DC	Open	9.5mm DVD±RW	None	None	AMT9	None	1-year	300W Gold Fixed	06/14
70F90008UX	US	Xeon E3-1225 v3 4C/3.2GHz/8MB/84W/DDR3-1600	1x4GB UDIMM DDR3-1600 ECC	RAID 100	2x3.5" DC	Open	9.5mm DVD±RW	None	None	AMT9	None	1-year	300W Gold Fixed	06/14
70F90009UX	US	Xeon E3-1245 v3 4C/3.4GHz/8MB/84W/DDR3-1600	1x4GB UDIMM DDR3-1600 ECC	RAID 100	2x3.5" DC	Open	9.5mm DVD±RW	None	None	AMT9	None	1-year	300W Gold Fixed	06/14
70F9000AUX	US	Core i3-4130 2C/3.4GHz/3MB/54W/DDR3-1600	1x4GB UDIMM DDR3-1600 ECC	RAID 500	2x3.5" DC	Open	9.5mm DVD±RW	None	None	AMT9	None	1-year	300W Gold Fixed	06/14
70F9000BUX	US	Xeon E3-1225 v3 4C/3.2GHz/8MB/84W/DDR3-1600	1x4GB UDIMM DDR3-1600 ECC	RAID 500	2x3.5" DC	Open	9.5mm DVD±RW	None	None	AMT9	None	1-year	300W Gold Fixed	06/14
70F9000CUX	US	Xeon E3-1245 v3 4C/3.4GHz/8MB/84W/DDR3-1600	1x4GB UDIMM DDR3-1600 ECC	RAID 500	2x3.5" DC	Open	9.5mm DVD±RW	None	None	AMT9	None	1-year	300W Gold Fixed	06/14
70F9000DUX	US	Xeon E3-1225 v3 4C/3.2GHz/8MB/84W/DDR3-1600	2x4GB UDIMM DDR3-1600 ECC	RAID 500	2x3.5" DC	Open	9.5mm DVD±RW	None	None	AMT9	None	1-year	300W Gold Fixed	06/14
70F9000EUX	US	Xeon E3-1245 v3 4C/3.4GHz/8MB/84W/DDR3-1600	2x8GB UDIMM DDR3-1600 ECC	RAID 500	2x3.5" DC	Open	9.5mm DVD±RW	None	None	AMT9	None	1-year	300W Gold Fixed	06/14
70F9000FUS	US	Xeon E3-1225 v3 4C/3.2GHz/8MB/84W/DDR3-1600	2x4GB UDIMM DDR3-1600 ECC	RAID 500	2x3.5" DC	2x500GB HDD 7.2K 3.5" SATA6Gbs	9.5mm DVD±RW	None	None	AMT9	2012 R2 Standard	1-year	300W Gold Fixed	06/14
70F9000GUS	US	Xeon E3-1245 v3 4C/3.4GHz/8MB/84W/DDR3-1600	2x8GB UDIMM DDR3-1600 ECC	RAID 500	2x3.5" DC	2x500GB HDD 7.2K 3.5" SATA6Gbs	9.5mm DVD±RW	None	None	AMT9	2012 R2 Standard	1-year	300W Gold Fixed	06/14
70F9000HUS	US	Xeon E3-1225 v3 4C/3.2GHz/8MB/84W/DDR3-1600	2x4GB UDIMM DDR3-1600 ECC	RAID 500	2x3.5" DC	2x500GB HDD 7.2K 3.5" SATA6Gbs	9.5mm DVD±RW	None	None	AMT9	2012 R2 Essentials	1-year	300W Gold Fixed	06/14
70F9001MUX	US	Core i3-4150 2C/3.5GHz/3MB/54W/DDR3-1600	1x4GB UDIMM DDR3-1600 ECC	RAID 100	2x3.5" DC	Open	9.5mm DVD±RW	None	None	AMT9	None	1-year	300W Gold Fixed	09/14
70F9001NUX	US	Xeon E3-1226 v3 4C/3.3GHz/8MB/84W/DDR3-1600	1x4GB UDIMM DDR3-1600 ECC	RAID 100	2x3.5" DC	Open	9.5mm DVD±RW	None	None	AMT9	None	1-year	300W Gold Fixed	09/14
70F9001PUX	US	Xeon E3-1246 v3 4C/3.5GHz/8MB/84W/DDR3-1600	1x4GB UDIMM DDR3-1600 ECC	RAID 100	2x3.5" DC	Open	9.5mm DVD±RW	None	None	AMT9	None	1-year	300W Gold Fixed	09/14
70F9001QUX	US	Xeon E3-1226 v3 4C/3.3GHz/8MB/84W/DDR3-1600	1x4GB UDIMM DDR3-1600 ECC	RAID 500	2x3.5" DC	Open	9.5mm DVD±RW	None	None	AMT9	None	1-year	300W Gold Fixed	09/14
70F9001RUX	US	Xeon E3-1246 v3 4C/3.5GHz/8MB/84W/DDR3-1600	1x4GB UDIMM DDR3-1600 ECC	RAID 500	2x3.5" DC	Open	9.5mm DVD±RW	None	None	AMT9	None	1-year	300W Gold Fixed	09/14
70F9001UUS	US	Xeon E3-1226 v3 4C/3.3GHz/8MB/84W/DDR3-1600	1x4GB UDIMM DDR3-1600 ECC	RAID 100	2x3.5" DC	2x500GB HDD 7.2K 3.5" SATA6Gbs	9.5mm DVD±RW	None	None	AMT9	2012 R2 Foundations	1-year	300W Gold Fixed	09/14

Model	Region	Processor	Memory	RAID Controller	Disk Bays	Storage	Optical	Add-on NIC	Add-on Ports	System Mgmt	OS	Warranty	Power Supply	Ann Date (m/y)
70F9001VUS	US	Xeon E3-1226 v3 4C/3.3GHz/8MB/84W/DDR3-1600	1x4GB UDIMM DDR3-1600 ECC	RAID 100	2x3.5" DC	2x500GB HDD 7.2K 3.5" SATA6Gbs	9.5mm DVD±RW	None	None	AMT9	2012 R2 Essentials	1-year	300W Gold Fixed	09/14

ThinkServer RS140 - 70F2

Product Specifications Reference (PSREF)

Model	Region	Processor	Memory	RAID Controller	Disk Bays	Storage	Optical	Add-on NIC	Add-on Ports	System Mgmt	OS	Warranty	Power Supply	Ann Date (m/y)
70F20001UX	US	Xeon E3-1225 v3 4C/3.2GHz/8MB/84W/DDR3-1600	2x4GB UDIMM DDR3-1600 ECC	RAID 100	4x2.5" DC	Open	None	None	None	AMT9	None	3-year	300W Gold Fixed	06/14
70F20002UX	US	Xeon E3-1245 v3 4C/3.4GHz/8MB/84W/DDR3-1600	2x8GB UDIMM DDR3-1600 ECC	RAID 700	4x2.5" DC	Open	None	None	None	AMT9	None	3-year	300W Gold Fixed	06/14

ThinkServer RS140 - 70F8

Product Specifications Reference (PSREF)

Model	Region	Processor	Memory	RAID Controller	Disk Bays	Storage	Optical	Add-on NIC	Add-on Ports	System Mgmt	OS	Warranty	Power Supply	Ann Date (m/y)
70F80000UX	US	Xeon E3-1225 v3 4C/3.2GHz/8MB/84W/DDR3-1600	2x4GB UDIMM DDR3-1600 ECC	RAID 100	2x3.5" DC	Open	9.5mm DVD±RW	None	None	AMT9	None	3-year	300W Gold Fixed	06/14
70F80001UX	US	Xeon E3-1245 v3 4C/3.4GHz/8MB/84W/DDR3-1600	2x8GB UDIMM DDR3-1600 ECC	RAID 500	2x3.5" DC	Open	9.5mm DVD±RW	None	None	AMT9	None	3-year	300W Gold Fixed	06/14



ThinkServer RS160 Platform Specifications

Product Specifications Reference (PSREF)

Components	Specification	Components	Specification		
Dimensions	1U rack. Height: 43.2 mm (1.7 in), width: 438.5 mm (17.26 in), depth: 393.7 mm (15.5 in)	Power supply	One fixed 300 watts power supply, Non-hot swap. 80 PLUS Gold qualified		
Weight	Minimum configuration: 6.2 kg (13.67 lb), maximum: 7.6 kg (16.76 lb)	Graphics	Onboard Aspeed AST2400		
Processor	Up to one Intel Xeon E3-1200 v5, Core i3, Pentium, or Celeron family processor. <i>Processors in italic will be available on November 2016.</i>	Front ports	Two USB 2.0		
	Xeon E3-1280 v5	4C/3.7GHz/8MB/80W/DDR4-2133	Rear ports	One VGA, four USB 3.0, one RJ-45 (dedicated mgmt), two ethernet, one serial (9-pin)	
	Xeon E3-1270 v5	4C/3.6GHz/8MB/80W/DDR4-2133	Cooling	3 fans for processor, PCIe slot, and disk drives	
	Xeon E3-1240 v5	4C/3.5GHz/8MB/80W/DDR4-2133	Noise emissions	Operating: < 5.9 Bels. Idle: < 5.2 Bels (Maximum configuration)	
	Xeon E3-1230 v5	4C/3.4GHz/8MB/80W/DDR4-2133	Environmental specification	Temperature - operating	50 °F to 95 °F (10 °C to 35 °C)
	Xeon E3-1220 v5	4C/3GHz/8MB/80W/DDR4-2133		Temperature - non operating (with package)	-40 °C to 60 °C
	Core i3-6320	2C/3.9GHz/4MB/51W/DDR4-2133		Altitude - operating	(Unpressurized): 0-10000ft (0-3048m)
	Core i3-6300	2C/3.8GHz/4MB/51W/DDR4-2133		Humidity - operating	8%-80%, non-condensing
	Core i3-6100	2C/3.7GHz/3MB/51W/DDR4-2133		Humidity - storage (with package)	10%-90%, non-condensing
	Pentium G4520	2C/3.6GHz/3MB/51W/DDR4-2133		Expansion slots	
	Pentium G4500	2C/3.5GHz/3MB/51W/DDR4-2133	Supports one PCIe slot via optional riser card		
	Pentium G4400	2C/3.3GHz/3MB/54W/DDR4-2133	Slot 1 (riser card 1) PCIe 3.0 x16, half length, half height		
	<i>Xeon E3-1260L v5</i>	<i>4C/2.9GHz/8MB/45W/DDR4-2133</i>			
	<i>Xeon E3-1240L v5</i>	<i>4C/2.1GHz/8MB/25W/DDR4-2133</i>			
	<i>Xeon E3-1225 v5</i>	<i>4C/3.3GHz/8MB/80W/DDR4-2133</i>			
	<i>Celeron G3920</i>	<i>2C/2.9GHz/2MB/51W/DDR4-2133</i>			
	<i>Celeron G3900</i>	<i>2C/2.8GHz/2MB/51W/DDR4-2133</i>			
	<i>Celeron G3900T</i>	<i>2C/2.6GHz/2MB/35W/DDR4-2133</i>			
Chipset	Intel C232 Platform Controller Hub (PCH)				
Memory DIMMs	4 DIMM sockets with 2 channels, 2 DIMMs per channel. UDIMM . DDR4-2133				
Memory capacity	64GB (16GB x 4)				
Memory protection	ECC				
RAID controller	RAID controller	Drive type	RAID support	Compatible models	
	Onboard RAID12i	6Gbs SATA	0/1/5/10	2x3.5", 4x2.5"	
	RAID520i PCIe	12Gbs SAS/SATA	0/1/10, 5 with optional key	2x3.5", 4x2.5"	
RAID720i PCIe	12Gbs SAS/SATA	0/1/10/5, 6 with optional cache	2x3.5", 4x2.5"		
Optional cache for RAID720i: 1GB DDR3 memory. 1GB, 2GB, or 4GB flash with super capacitor. Flash options include CacheVault, CacheCade Pro, and FastPath.					
Disk drive bays	Supports two 3.5" or four 2.5" disk drive bays. Non-hot swap. Cables are connected to onboard SATA connectors or PCIe RAID controller. Also supports one M.2 SATA SSD				
Supporting storage	3.5" HDD, 7.2K SATA6Gbs	1TB/2TB/4TB/6TB/8TB			
	3.5" HDD, 7.2K SAS12Gbs	1TB/2TB/4TB/6TB/8TB			
	2.5" HDD, 7.2K SATA6Gbs	1TB/2TB			
	2.5" HDD, 10K SAS12Gbs	300GB/600GB/900GB/1.2TB			
	2.5" SSD, SATA6Gbs	120GB/240GB/480GB/960GB			
M.2 SATA SSD	32GB/128GB (128GB M.2 SATA SSD will be available on November 2016)				
Optical drive	Optional one 9.5mm optical. DVD-ROM or DVD±RW				
Network interfaces	One dedicated management port, two Gigabit Ethernet ports. Supports optional discrete network adapters via riser card				
Security features	Power-on and administrator password. Optional TPM (TCG 1.2-compliant)				
Systems management	UEFI. Onboard Aspeed AST2400 graphics/management processor, IPMI 2.0-compliant baseboard management controller (BMC). Control Panel LEDs shows the status of power, ID, disk drives, network, system. Supports the following management software: EasyStartup, Power Planner. On November 2016, EasyUpdate, Lenovo ThinkServer Diagnostics Standalone, ToolsCenter Suite CLI inventory module on ThinkServer, and Lenovo xClarity Administrator will be available				
Operating systems	Microsoft Windows Server 2016 (Standard and Essentials)/2012 R2/2012. Windows 10 Pro. Red Hat Enterprise Linux 6.7/6.8/7.2. SUSE Linux Enterprise Server 11/12. VMware vSphere (ESXi) 6.0Ub/U2				
Base warranty	1 or 3-year limited onsite service with 9x5/NBD				

Model	Region	Processor	Memory	RAID Controller	Disk Bays	Storage(HDD/SSD)	Optical	Add-on NIC	Slots	TPM	OS	Warranty	Power Supply	Ann Date (m/y)
70TE000DUX	US	Xeon E3-1220 v5 4C/3GHz/8MB/80W/DDR4-2133	1x8GB UDIMM DDR4-2133 ECC	RAID 121i	4x2.5" NHS	Open	None	None	None	TPM	None	1-year	300W 85% Fixed	09/16
70TE000EUX	US	Xeon E3-1230 v5 4C/3.4GHz/8MB/80W/DDR4-2133	1x8GB UDIMM DDR4-2133 ECC	RAID 121i	4x2.5" NHS	Open	None	None	None	TPM	None	1-year	300W 85% Fixed	09/16
70TE000FUX	US	Xeon E3-1240 v5 4C/3.5GHz/8MB/80W/DDR4-2133	1x8GB UDIMM DDR4-2133 ECC	RAID 121i	4x2.5" NHS	Open	None	None	None	TPM	None	1-year	300W 85% Fixed	09/16
70TE000GUX	US	Xeon E3-1270 v5 4C/3.6GHz/8MB/80W/DDR4-2133	1x8GB UDIMM DDR4-2133 ECC	RAID 121i	4x2.5" NHS	Open	None	None	None	TPM	None	1-year	300W 85% Fixed	09/16
70TE000HUX	US	Xeon E3-1280 v5 4C/3.7GHz/8MB/80W/DDR4-2133	1x8GB UDIMM DDR4-2133 ECC	RAID 121i	4x2.5" NHS	Open	None	None	None	TPM	None	1-year	300W 85% Fixed	09/16
70TER001UX	US	Xeon E3-1220 v5 4C/3GHz/8MB/80W/DDR4-2133	1x8GB UDIMM DDR4-2133 ECC	RAID 121i	4x2.5" NHS	Open	None	None	1xHHHL	TPM	None	1-year	300W 85% Fixed	09/16
70TER002UX	US	Xeon E3-1230 v5 4C/3.4GHz/8MB/80W/DDR4-2133	1x8GB UDIMM DDR4-2133 ECC	RAID 121i	4x2.5" NHS	Open	None	None	1xHHHL	TPM	None	1-year	300W 85% Fixed	09/16
70TER003UX	US	Xeon E3-1270 v5 4C/3.6GHz/8MB/80W/DDR4-2133	1x8GB UDIMM DDR4-2133 ECC	RAID 121i	4x2.5" NHS	Open	None	None	1xHHHL	TPM	None	1-year	300W 85% Fixed	09/16

Model	Region	Processor	Memory	RAID Controller	Disk Bays	Storage(HDD/SSD)	Optical	Add-on NIC	Slots	TPM	OS	Warranty	Power Supply	Ann Date (m/y)
70TG000JUX	US	Pentium G4400 2C/3.3GHz/3MB/54W/DDR4-2133	1x8GB UDIMM DDR4-2133 ECC	RAID 121i	2x3.5" NHS	Open	None	None	None	TPM	None	1-year	300W 85% Fixed	09/16
70TG000KUX	US	Xeon E3-1220 v5 4C/3GHz/8MB/80W/DDR4-2133	1x8GB UDIMM DDR4-2133 ECC	RAID 121i	2x3.5" NHS	Open	None	None	None	TPM	None	1-year	300W 85% Fixed	09/16
70TG000LUX	US	Xeon E3-1230 v5 4C/3.4GHz/8MB/80W/DDR4-2133	1x8GB UDIMM DDR4-2133 ECC	RAID 121i	2x3.5" NHS	Open	None	None	None	TPM	None	1-year	300W 85% Fixed	09/16
70TG000MUX	US	Xeon E3-1240 v5 4C/3.5GHz/8MB/80W/DDR4-2133	1x8GB UDIMM DDR4-2133 ECC	RAID 121i	2x3.5" NHS	Open	None	None	None	TPM	None	1-year	300W 85% Fixed	09/16
70TG000NUX	US	Xeon E3-1270 v5 4C/3.6GHz/8MB/80W/DDR4-2133	1x8GB UDIMM DDR4-2133 ECC	RAID 121i	2x3.5" NHS	Open	None	None	None	TPM	None	1-year	300W 85% Fixed	09/16
70TG000PUX	US	Xeon E3-1280 v5 4C/3.7GHz/8MB/80W/DDR4-2133	1x8GB UDIMM DDR4-2133 ECC	RAID 121i	2x3.5" NHS	Open	None	None	None	TPM	None	1-year	300W 85% Fixed	09/16
70TGR001UX	US	Pentium G4400 2C/3.3GHz/3MB/54W/DDR4-2133	1x8GB UDIMM DDR4-2133 ECC	RAID 121i	2x3.5" NHS	Open	None	None	1xHHHL	TPM	None	1-year	300W 85% Fixed	09/16
70TGR002UX	US	Xeon E3-1220 v5 4C/3GHz/8MB/80W/DDR4-2133	1x8GB UDIMM DDR4-2133 ECC	RAID 121i	2x3.5" NHS	Open	None	None	1xHHHL	TPM	None	1-year	300W 85% Fixed	09/16
70TGR003UX	US	Xeon E3-1230 v5 4C/3.4GHz/8MB/80W/DDR4-2133	1x8GB UDIMM DDR4-2133 ECC	RAID 121i	2x3.5" NHS	Open	None	None	1xHHHL	TPM	None	1-year	300W 85% Fixed	09/16

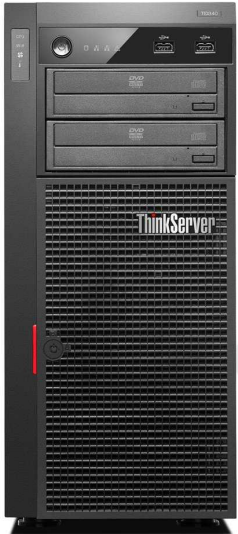

ThinkServer TD340 Platform Specifications

Components	Specification																																									
Dimensions	Tower or 5U rack. Height: 430 mm (16.9 in), width: 195 mm (7.68 in), depth: 595 mm (23.4 in)																																									
Weight	Maximum: 26 kg (57.3 lb)																																									
Processor	Up to two 95W Intel Xeon E5-2400 v2 family (code name: Ivy Bridge EN) processors with 10 cores up to 2.4GHz, 8 cores up to 2.5GHz, 6 cores up to 2.5GHz, 4 cores up to 2.4GHz. One QPI link up to 8.0 GT/s. Up to 1600MHz memory speed. Up to 25MB cache. Or up to two Intel Xeon E5-2420 (code name: Sandy Bridge EN) processors with 6 cores, 1.9GHz, 15MB cache, 95W, up to 1333MHz memory speed, one 7.2GT/s QPI link																																									
Chipset	Intel C606 Platform Controller Hub (PCH)																																									
Memory DIMMs	12 DIMM sockets (6 DIMMs per processor). 6-channel capable (3-channel per processor). RDIMM, LV RDIMM and LV UDIMM (cannot be intermixed). DDR3. Up to 1866MHz (RDIMM), 1600MHz (LV RDIMM) or 1600MHz (LV UDIMM)																																									
Memory capacity	192GB (RDIMM and LV RDIMM), 16GB x 12/48GB (LV UDIMM, 4GB x 12)																																									
Memory protection	ECC, memory mirroring, memory sparing																																									
AnyRAID support	Supports one of the following: RAID 0, 1, 10 with onboard RAID 100, 6Gb/s SATA, optional key for RAID 5. RAID 0, 1, 10 with onboard RAID 300, 6Gb/s SAS/SATA, optional key for RAID 5. RAID 0, 1, 10 with RAID 500, PCIe adapter, 6Gb/s SAS/SATA, optional key for RAID 5, 50. RAID 0, 1, 10, 5, 50, 6, 60 with RAID 700, PCIe adapter, 512MB cache, optional intelligent Battery Backup Unit (iBBU08). RAID 0, 1, 10, 5, 50, 6, 60 with RAID 710, PCIe adapter, 1GB cache, optional CacheVault flash cache with super capacitor/CacheCade Pro 2.0/FastPath key <i>Note: At least 6 disk drives is required for RAID 50 and 60.</i>																																									
Disk drive bays	Up to 8 3.5" hot-swap bays, or up to 16 2.5" hot-swap bays, or up to 4 3.5" non-hot swap bays. On front. Supports internal RDX tape drive, consumes 5.25" bay, also supports optional external SAS tape drive, additional SAS HBA card is needed. <table border="1"> <thead> <tr> <th rowspan="2">Disk bay configuration</th> <th colspan="5">RAID controller requirements</th> </tr> <tr> <th>RAID100</th> <th>RAID300</th> <th>RAID500</th> <th>RAID700</th> <th>RAID710</th> </tr> </thead> <tbody> <tr> <td>4x3.5" non-hot swap</td> <td>•</td> <td></td> <td></td> <td></td> <td></td> </tr> <tr> <td>4x3.5" HS</td> <td>•</td> <td>•</td> <td>•</td> <td>•</td> <td>•</td> </tr> <tr> <td>8x3.5" HS</td> <td></td> <td>•</td> <td>•</td> <td>•</td> <td>•</td> </tr> <tr> <td>8x2.5" HS</td> <td></td> <td>•</td> <td>•</td> <td>•</td> <td>•</td> </tr> <tr> <td>16x2.5" HS</td> <td></td> <td></td> <td>•</td> <td>•</td> <td>•</td> </tr> </tbody> </table>	Disk bay configuration	RAID controller requirements					RAID100	RAID300	RAID500	RAID700	RAID710	4x3.5" non-hot swap	•					4x3.5" HS	•	•	•	•	•	8x3.5" HS		•	•	•	•	8x2.5" HS		•	•	•	•	16x2.5" HS			•	•	•
Disk bay configuration	RAID controller requirements																																									
	RAID100	RAID300	RAID500	RAID700	RAID710																																					
4x3.5" non-hot swap	•																																									
4x3.5" HS	•	•	•	•	•																																					
8x3.5" HS		•	•	•	•																																					
8x2.5" HS		•	•	•	•																																					
16x2.5" HS			•	•	•																																					
Supporting disk drives	<table border="1"> <tbody> <tr> <td>3.5" SATA HDD (both HS and NHS)</td> <td>7.2K 6Gbs: 7.2K 6Gbs: 500GB/1TB/2TB/3TB/4TB</td> </tr> <tr> <td>3.5" SAS HDD (HS)</td> <td>7.2K 6Gbs: 1TB/2TB/3TB/4TB. 15K 6Gbs: 300GB/600GB</td> </tr> <tr> <td>2.5" SATA HDD (HS)</td> <td>7.2K 6Gbs: 500GB/1TB. 10K 6Gbs: 300GB/600GB/900GB</td> </tr> <tr> <td>2.5" SAS HDD (HS)</td> <td>15K 6Gbs: 146GB/300GB/600GB</td> </tr> <tr> <td>2.5" SATA SSD (HS, also supports 3.5" HS bay)</td> <td>6Gbs: 120GB/240GB/300GB/480GB/600GB</td> </tr> <tr> <td>2.5" SAS SSD (HS, also supports 3.5" HS bay)</td> <td>12Gbs: 200GB/400GB/800GB</td> </tr> <tr> <td>PCIe SSD</td> <td>1.4TB, via PCIe 2.0 x8 adapter</td> </tr> </tbody> </table> <p><i>Note: Supports up to 2 SSD drives on 8 x 3.5" HS model, up to 4 SSD drives on 16 x 2.5" HS model.</i></p>	3.5" SATA HDD (both HS and NHS)	7.2K 6Gbs: 7.2K 6Gbs: 500GB/1TB/2TB/3TB/4TB	3.5" SAS HDD (HS)	7.2K 6Gbs: 1TB/2TB/3TB/4TB. 15K 6Gbs: 300GB/600GB	2.5" SATA HDD (HS)	7.2K 6Gbs: 500GB/1TB. 10K 6Gbs: 300GB/600GB/900GB	2.5" SAS HDD (HS)	15K 6Gbs: 146GB/300GB/600GB	2.5" SATA SSD (HS, also supports 3.5" HS bay)	6Gbs: 120GB/240GB/300GB/480GB/600GB	2.5" SAS SSD (HS, also supports 3.5" HS bay)	12Gbs: 200GB/400GB/800GB	PCIe SSD	1.4TB, via PCIe 2.0 x8 adapter																											
3.5" SATA HDD (both HS and NHS)	7.2K 6Gbs: 7.2K 6Gbs: 500GB/1TB/2TB/3TB/4TB																																									
3.5" SAS HDD (HS)	7.2K 6Gbs: 1TB/2TB/3TB/4TB. 15K 6Gbs: 300GB/600GB																																									
2.5" SATA HDD (HS)	7.2K 6Gbs: 500GB/1TB. 10K 6Gbs: 300GB/600GB/900GB																																									
2.5" SAS HDD (HS)	15K 6Gbs: 146GB/300GB/600GB																																									
2.5" SATA SSD (HS, also supports 3.5" HS bay)	6Gbs: 120GB/240GB/300GB/480GB/600GB																																									
2.5" SAS SSD (HS, also supports 3.5" HS bay)	12Gbs: 200GB/400GB/800GB																																									
PCIe SSD	1.4TB, via PCIe 2.0 x8 adapter																																									
Optical drive	Two 5.25" bays for optical drive. DVD-ROM or DVD±RW. Half-height																																									
Network interfaces	Two Gigabit Ethernet port via two Intel 82574L. One port is shared with ThinkServer Management Module. Supports optional discrete network adapters via PCIe slots																																									

Components	Specification	
Security features	Power-on and administrator password. Optional TPM (TCG 1.2-compliant)	
Intelligent Diagnostics Module (IDM)	Supports IDM or IDM Premium on selected models, IDM LED lights indicate failing component category, IDM Premium LED lights indicate individual failing part	
Systems management	Supports ThinkServer Management Module (TMM), optional TMM Premium for remote presence. Onboard Aspeed AST2300 graphics/management processor, IPMI 2.0-compliant baseboard management controller (BMC). Front control panel LEDs shows the status of power, hard drive activity, network, system. Supports EasyStartup, EasyManage, EasyUpdate.	
Operating systems supported	Microsoft Windows Server 2012 R2/2012/2008 R2/2008. Windows Small Business Server 2011. Red Hat Enterprise Linux 7.1/7/6.7/6.5/6.4/5.10/5.9. SUSE Linux Enterprise Server 11/10. VMware vSphere (ESXi) 5.5/5.1	
Base warranty	1 or 3-year limited onsite service with 9x5/NBD.	
Power supply	One fixed 625 watts, universal, 80 PLUS Bronze qualified. Or up to two redundant 800 watts, two maximum, rear access, hot-swap, 80 PLUS Gold qualified, redundant with two power supplies	
Graphics	Onboard Aspeed AST2300 graphics/management processor	
Front ports	Two USB 2.0	
Rear ports	Four USB 2.0, one serial (9-pin), two ethernet (RJ-45, one for dedicate/share mgmt), one analog VGA DB-15 connector	
Noise emissions	Operating: < 42 dB(A). Idle: < 38 dB(A) (Maximum configuration)	
Environmental specification	Energy Star Server 1.1 qualified for 625W models, Energy Star Server 2.0 qualified for 800W models. RoHS-compliant.	
	Temperature - operating	50 °F to 95 °F (10 °C to 35 °C)
	Temperature - storage (with package)	-40 °C to 60 °C
	Altitude - operating	Supported Altitude (unpressurized): 0-10000ft (0-3048m)
	Humidity - operating	10%~80%, non-condensing
	Humidity - storage (with package)	8%~90%, non-condensing



Expansion slots

Slot 1 (PCH)	32-bit PCI 2.3, half-length, full-height
Slot 2 (CPU1)	PCIe 3.0 x8 (x4 elec), half-length, full-height
Slot 3 (CPU2)	PCIe 3.0 x8, half-length, full-height
Slot 4 (CPU2)	PCIe 3.0 x8, half-length, full-height
Slot 5 (CPU1)	PCIe 3.0 x16, half-length, full-height
Slot 6 (CPU2)	PCIe 3.0 x8, half-length, full-height

ThinkServer TD340 - TopSeller - 70B5

Product Specifications Reference (PSREF)

Model	Region	Processor	Memory	RAID Controller	Disk Bays	Storage	Optical	Add-on NIC	TPM	Diagnostics	System Mgmt	OS	Warranty	Power Supply	Ann Date (m/y)
70B5001TUX	US	1xE5-2403 v2 4C/1.8GHz/10MB/80W/DDR3-1333	1x8GB RDIMM DDR3-1600 ECC	RAID 300	4x3.5" HS	Open	HH DVD±RW	None	TPM	IDM Premium	TMM	None	1-year	625W Bronze Fixed	05/14

Model	Region	Processor	Memory	RAID Controller	Disk Bays	Storage	Optical	Add-on NIC	TPM	Diagnostics	System Mgmt	OS	Warranty	Power Supply	Ann Date (m/y)
70B7002GUX	US	1xE5-2403 v2 4C/1.8GHz/10MB/80W/DDR3-1333	1x8GB RDIMM DDR3-1600 ECC	RAID 300	4x3.5" HS	Open	HH DVD±RW	None	TPM	IDM	TMM	None	1-year	800Wx1 Gold	01/14
70B7002HUX	US	1xE5-2407 v2 4C/2.4GHz/10MB/80W/DDR3-1333	1x8GB RDIMM DDR3-1600 ECC	RAID 300	4x3.5" HS	Open	HH DVD±RW	None	TPM	IDM	TMM	None	1-year	800Wx1 Gold	01/14
70B7002JUX	US	1xE5-2403 v2 4C/1.8GHz/10MB/80W/DDR3-1333	1x8GB RDIMM DDR3-1600 ECC	RAID 300	4x3.5" HS	Open	HH DVD±RW	None	TPM	IDM Premium	TMM	None	3-year	800Wx1 Gold	01/14
70B7002KUX	US	1xE5-2407 v2 4C/2.4GHz/10MB/80W/DDR3-1333	1x8GB RDIMM DDR3-1600 ECC	RAID 300	4x3.5" HS	Open	HH DVD±RW	None	TPM	IDM Premium	TMM	None	3-year	800Wx1 Gold	01/14
70B7002LUX	US	1xE5-2420 v2 6C/2.2GHz/15MB/80W/DDR3-1600	1x8GB RDIMM DDR3-1600 ECC	RAID 300	4x3.5" HS	Open	HH DVD±RW	None	TPM	IDM Premium	TMM	None	3-year	800Wx1 Gold	01/14
70B7002MUX	US	1xE5-2430 v2 6C/2.5GHz/15MB/80W/DDR3-1600	1x8GB RDIMM DDR3-1600 ECC	RAID 300	4x3.5" HS	Open	HH DVD±RW	None	TPM	IDM Premium	TMM	None	3-year	800Wx1 Gold	01/14
70B7002NUX	US	1xE5-2440 v2 8C/1.9GHz/20MB/95W/DDR3-1600	1x8GB RDIMM DDR3-1600 ECC	RAID 300	4x3.5" HS	Open	HH DVD±RW	None	TPM	IDM Premium	TMM	None	3-year	800Wx1 Gold	01/14
70B7002PUX	US	1xE5-2450 v2 8C/2.5GHz/20MB/95W/DDR3-1600	1x8GB RDIMM DDR3-1600 ECC	RAID 300	4x3.5" HS	Open	HH DVD±RW	None	TPM	IDM Premium	TMM	None	3-year	800Wx1 Gold	01/14
70B7002QUX	US	1xE5-2470 v2 10C/2.4GHz/25MB/95W/DDR3-1600	1x8GB RDIMM DDR3-1600 ECC	RAID 300	4x3.5" HS	Open	HH DVD±RW	None	TPM	IDM Premium	TMM	None	3-year	800Wx1 Gold	01/14
70B7002RUX	US	1xE5-2420 v2 6C/2.2GHz/15MB/80W/DDR3-1600	1x8GB RDIMM DDR3-1600 ECC	RAID 300	8x3.5" HS	Open	HH DVD±RW	None	TPM	IDM Premium	TMM	None	3-year	800Wx1 Gold	01/14
70B7002SUX	US	1xE5-2430 v2 6C/2.5GHz/15MB/80W/DDR3-1600	1x8GB RDIMM DDR3-1600 ECC	RAID 300	8x3.5" HS	Open	HH DVD±RW	None	TPM	IDM Premium	TMM	None	3-year	800Wx1 Gold	01/14
70B7002TUX	US	1xE5-2440 v2 8C/1.9GHz/20MB/95W/DDR3-1600	1x8GB RDIMM DDR3-1600 ECC	RAID 300	8x3.5" HS	Open	HH DVD±RW	None	TPM	IDM Premium	TMM	None	3-year	800Wx1 Gold	01/14
70B7002UUX	US	1xE5-2450 v2 8C/2.5GHz/20MB/95W/DDR3-1600	1x8GB RDIMM DDR3-1600 ECC	RAID 300	8x3.5" HS	Open	HH DVD±RW	None	TPM	IDM Premium	TMM	None	3-year	800Wx1 Gold	01/14
70B7002VUX	US	1xE5-2470 v2 10C/2.4GHz/25MB/95W/DDR3-1600	1x8GB RDIMM DDR3-1600 ECC	RAID 300	8x3.5" HS	Open	HH DVD±RW	None	TPM	IDM Premium	TMM	None	3-year	800Wx1 Gold	01/14
70B7002WUX	US	1xE5-2420 v2 6C/2.2GHz/15MB/80W/DDR3-1600	1x8GB RDIMM DDR3-1600 ECC	RAID 300	8x2.5" HS	Open	HH DVD±RW	None	TPM	IDM Premium	TMM	None	3-year	800Wx1 Gold	01/14
70B7002XUX	US	1xE5-2430 v2 6C/2.5GHz/15MB/80W/DDR3-1600	1x8GB RDIMM DDR3-1600 ECC	RAID 300	8x2.5" HS	Open	HH DVD±RW	None	TPM	IDM Premium	TMM	None	3-year	800Wx1 Gold	01/14
70B7002YUX	US	1xE5-2440 v2 8C/1.9GHz/20MB/95W/DDR3-1600	1x8GB RDIMM DDR3-1600 ECC	RAID 300	8x2.5" HS	Open	HH DVD±RW	None	TPM	IDM Premium	TMM	None	3-year	800Wx1 Gold	01/14

Model	Region	Processor	Memory	RAID Controller	Disk Bays	Storage	Optical	Add-on NIC	TPM	Diagnostics	System Mgmt	OS	Warranty	Power Supply	Ann Date (m/y)
70B70030UX	US	1xE5-2450 v2 8C/2.5GHz/20MB/95W/DDR3-1600	1x8GB RDIMM DDR3-1600 ECC	RAID 300	8x2.5" HS	Open	HH DVD±RW	None	TPM	IDM Premium	TMM	None	3-year	800Wx1 Gold	01/14
70B70031UX	US	1xE5-2470 v2 10C/2.4GHz/25MB/95W/DDR3-1600	1x8GB RDIMM DDR3-1600 ECC	RAID 300	8x2.5" HS	Open	HH DVD±RW	None	TPM	IDM Premium	TMM	None	3-year	800Wx1 Gold	01/14
70B70032UX	US	1xE5-2420 v2 6C/2.2GHz/15MB/80W/DDR3-1600	1x8GB RDIMM DDR3-1600 ECC	RAID 700	16x2.5" HS	Open	HH DVD±RW	None	TPM	IDM Premium	TMM	None	3-year	800Wx1 Gold	01/14
70B70033UX	US	1xE5-2430 v2 6C/2.5GHz/15MB/80W/DDR3-1600	1x8GB RDIMM DDR3-1600 ECC	RAID 700	16x2.5" HS	Open	HH DVD±RW	None	TPM	IDM Premium	TMM	None	3-year	800Wx1 Gold	01/14
70B70034UX	US	1xE5-2440 v2 8C/1.9GHz/20MB/95W/DDR3-1600	1x8GB RDIMM DDR3-1600 ECC	RAID 700	16x2.5" HS	Open	HH DVD±RW	None	TPM	IDM Premium	TMM	None	3-year	800Wx1 Gold	01/14
70B70035UX	US	1xE5-2450 v2 8C/2.5GHz/20MB/95W/DDR3-1600	1x8GB RDIMM DDR3-1600 ECC	RAID 710	16x2.5" HS	Open	HH DVD±RW	None	TPM	IDM Premium	TMM	None	3-year	800Wx1 Gold	01/14
70B70036UX	US	1xE5-2470 v2 10C/2.4GHz/25MB/95W/DDR3-1600	1x8GB RDIMM DDR3-1600 ECC	RAID 710	16x2.5" HS	Open	HH DVD±RW	None	TPM	IDM Premium	TMM	None	3-year	800Wx1 Gold	01/14
70B7004DUX	US	2xE5-2420 v2 6C/2.2GHz/15MB/80W/DDR3-1600	2x16GB RDIMM DDR3-1866 ECC	RAID 300	8x3.5" HS	Open	HH DVD±RW	None	TPM	IDM Premium	TMM Premium	None	3-year	800Wx2 Gold	09/15

Model	Region	Processor	Memory	RAID Controller	Disk Bays	Storage	Optical	Add-on NIC	TPM	Diagnostics	System Mgmt	OS	Warranty	Power Supply	Ann Date (m/y)
70B60002UX	US	1xE5-2420 v2 6C/2.2GHz/15MB/80W/DDR3-1600	4x8GB RDIMM DDR3-1600 ECC	RAID 500+Key	4x3.5" HS	4x2TB HDD 7.2K 3.5" SATA6Gbs	HH DVD±RW	2xGbE	TPM	IDM Premium	TMM Premium	None	3-year	800Wx2 Gold	01/14
70B60003UX	US	2xE5-2440 v2 8C/1.9GHz/20MB/95W/DDR3-1600	8x8GB RDIMM DDR3-1600 ECC	RAID 700	8x3.5" HS	8x2TB 3.5" SAS6Gbs 7.2K	HH DVD±RW	2xGbE	TPM	IDM Premium	TMM Premium	None	3-year	800Wx2 Gold	01/14
70B60004UX	US	2xE5-2450 v2 8C/2.5GHz/20MB/95W/DDR3-1600	12x8GB RDIMM DDR3-1600 ECC	RAID 710+CacheVault	16x2.5" HS	8x300GB HDD 15K 2.5" SAS6Gbs	HH DVD±RW	4xGbE	TPM	IDM Premium	TMM Premium	None	3-year	800Wx2 Gold	01/14
70B60005UX	US	1xE5-2407 v2 4C/2.4GHz/10MB/80W/DDR3-1333	1x8GB RDIMM DDR3-1600 ECC	RAID 300+Key	4x3.5" HS	Open	HH DVD±RW	None	TPM	IDM Premium	TMM	None	3-year	800Wx1 Gold	04/14
70B60006UX	US	1xE5-2420 v2 6C/2.2GHz/15MB/80W/DDR3-1600	1x8GB RDIMM DDR3-1600 ECC	RAID 500	8x3.5" HS	Open	HH DVD±RW	None	TPM	IDM Premium	TMM	None	3-year	800Wx1 Gold	04/14
70B60007UX	US	1xE5-2420 v2 6C/2.2GHz/15MB/80W/DDR3-1600	1x8GB RDIMM DDR3-1600 ECC	RAID 700	8x3.5" HS	Open	HH DVD±RW	None	TPM	IDM Premium	TMM Premium	None	3-year	800Wx2 Gold	04/14
70B60008UX	US	1xE5-2440 v2 8C/1.9GHz/20MB/95W/DDR3-1600	1x8GB RDIMM DDR3-1600 ECC	RAID 700	8x2.5" HS	Open	HH DVD±RW	None	TPM	IDM Premium	TMM	None	3-year	800Wx1 Gold	04/14
70B60009UX	US	1xE5-2450 v2 8C/2.5GHz/20MB/95W/DDR3-1600	1x16GB RDIMM DDR3-1600 ECC	RAID 710	16x2.5" HS	Open	HH DVD±RW	None	TPM	IDM Premium	TMM Premium	None	3-year	800Wx2 Gold	04/14



ThinkServer TD350 Platform Specifications

Product Specifications Reference (PSREF)

Components	Specification
Dimensions	Tower or 4U rack. Tower: Height: 459 mm (18.1 in), width: 251 mm (9.9 in), depth: 686 mm (27 in) Rack: height: 173 mm (6.8 in), width: 482 mm (19 in), depth: 686 mm (27 in)
Weight	Minimum configuration: 22 kg (48.5 lb), maximum: 41.4 kg (91.27 lb)
Processor	Up to two 135W Intel Xeon E5-2600 v4 or E5-2600 v3 family processors.
	E5-2698 v4 20C/2.2GHz/50MB/135W/DDR4-2400
	E5-2695 v4 18C/2.1GHz/45MB/120W/DDR4-2400
	E5-2690 v4 14C/2.6GHz/35MB/135W/DDR4-2400
	E5-2683 v4 16C/2.1GHz/40MB/120W/DDR4-2400
	E5-2680 v4 14C/2.4GHz/35MB/120W/DDR4-2400
	E5-2667 v4 8C/3.2GHz/25MB/135W/DDR4-2400
	E5-2660 v4 14C/2GHz/35MB/105W/DDR4-2400
	E5-2650L v4 14C/1.7GHz/35MB/65W/DDR4-2400
	E5-2650 v4 12C/2.2GHz/30MB/105W/DDR4-2400
	E5-2643 v4 6C/3.4GHz/20MB/135W/DDR4-2400
	E5-2640 v4 10C/2.4GHz/25MB/90W/DDR4-2133
	E5-2637 v4 4C/3.5GHz/15MB/135W/DDR4-2400
	E5-2630L v4 10C/1.8GHz/25MB/55W/DDR4-2133
	E5-2630 v4 10C/2.2GHz/20MB/85W/DDR4-2133
	E5-2623 v4 4C/2.6GHz/10MB/85W/DDR4-2133
	E5-2620 v4 8C/2.1GHz/20MB/85W/DDR4-2133
	E5-2609 v4 8C/1.7GHz/20MB/85W/DDR4-1866
	E5-2603 v4 6C/1.7GHz/15MB/85W/DDR4-1866
	E5-2698 v3 16C/2.3GHz/40MB/135W/DDR4-2133
	E5-2695 v3 14C/2.3GHz/35MB/120W/DDR4-2133
	E5-2690 v3 12C/2.6GHz/30MB/135W/DDR4-2133
	E5-2685 v3 12C/2.6GHz/30MB/120W/DDR4-2133
	E5-2683 v3 14C/2GHz/35MB/120W/DDR4-2133
	E5-2680 v3 12C/2.5GHz/30MB/120W/DDR4-2133
	E5-2670 v3 12C/2.3GHz/30MB/120W/DDR4-2133
	E5-2667 v3 8C/3.2GHz/20MB/135W/DDR4-2133
	E5-2660 v3 10C/2.6GHz/25MB/105W/DDR4-2133
	E5-2650L v3 12C/1.8GHz/30MB/65W/DDR4-2133
	E5-2650 v3 10C/2.3GHz/25MB/105W/DDR4-2133
	E5-2643 v3 6C/3.4GHz/20MB/135W/DDR4-2133
	E5-2640 v3 8C/2.6GHz/20MB/90W/DDR4-1866
	E5-2637 v3 4C/3.5GHz/15MB/135W/DDR4-2133
E5-2630L v3 8C/1.8GHz/20MB/55W/DDR4-1866	
E5-2630 v3 8C/2.4GHz/20MB/85W/DDR4-1866	
E5-2623 v3 4C/3GHz/10MB/105W/DDR4-1866	
E5-2620 v3 6C/2.4GHz/15MB/85W/DDR4-1866	
E5-2609 v3 6C/1.9GHz/15MB/85W/DDR4-1600	
E5-2603 v3 6C/1.6GHz/15MB/85W/DDR4-1600	
Chipset	Intel C612 Platform Controller Hub (PCH)
Memory DIMMs	16 DIMM sockets (8 DIMMs per processor), 8-channel capable (4-channel per processor). RDIMM and LRDIMM (cannot be intermixed), DDR4, up to 2400MHz
Memory capacity	512GB (RDIMM, 32GB x 16)/1024GB (LRDIMM, 64GB x 16), 2nd CPU is needed
Memory protection	ECC, memory mirroring, lockstep, and memory sparing
RAID controller	RAID controller Drive type RAID support Compatible models
	Onboard RAID110i 6Gbs SATA 0/1/10.5 with optional key 5x3.5" HS/ES, 8x2.5" HS
	RAID520i PCIe 12Gbs SAS/SATA 0/1/10.5/50 with optional key 5x3.5" HS, 8x2.5" HS
	RAID720i PCIe 12Gbs SAS/SATA 0/1/10.5/50, 6/60 with optional cache 5x3.5" HS, 8x2.5" HS
	AnyRAID 510i 6Gbs SAS/SATA 0/1/10.5/50 with optional key 5x3.5" HS, 8x2.5" HS
	AnyRAID 720i 12Gbs SAS/SATA 0/1/10.5/50, 6/60 with optional cache 5x3.5" HS, 8x2.5" HS
	AnyRAID 720ix 12Gbs SAS/SATA 0/1/10.5/50/6/60 15x3.5" HS, 16/32x2.5" HS
Disk drive bays	Optional cache for RAID 720/AnyRAID 720i and 720ix: 1GB read-only memory or 1GB/2GB/4GB flash with super capacitor. Flash options include CacheVault, Cache-Cade Pro, and FastPath. 720ix must have cache. Up to 15 3.5" or 32 2.5" hot-swap bays, or up to 5 3.5" easy-swap bays, on front. Up to 2 M.2 SSD drives via optional M.2 module. Up to one internal LTO-6 SAS tape drive on 720ix model, or external RDX tape drive via USB.

Components	Specification			
Maximum internal storage	3.5" model: up to 120TB with 7.2K SATA or SAS HDD, up to 27TB with 10K SAS HDD, up to 9TB with 15K SAS HDD, or up to 24TB with SATA or SAS SSD. 2.5" model: up to 64TB with 7.2K SATA HDD, up to 57.6TB with 10K SAS HDD, up to 19.2TB with 15K SAS HDD, or up to 51.2TB with SATA or SAS SSD			
SD module	Up to 2 SDHC flash cards via optional SD module, 8GB or 32GB each			
Optical drive	Two 5.25" bays for optical drive. DVD-ROM or DVD±RW. Half-height or 9.5mm			
Network interfaces	One dedicate management port, two gigabit ethernet ports. Supports optional discrete network adapters via PCIe slots			
Security features	Power-on and administrator password. Optional TPM (TCG 1.2 or 2.0-compliant)			
Systems management	Supports ThinkServer System Manager (TSM), optional TSM Premium for remote presence. UEFI. Onboard Aspeed AST2400 graphics/management processor, IPMI 2.0-compliant baseboard management controller (BMC). Control Panel LEDs shows the status of power, ID, network, system. Supports ThinkServer Diagnostics, ThinkServer Deployment Manager, ThinkServer Energy Manager, ThinkServer System Manager CLI, Lenovo ThinkServer Partner Pack for VMware vCenter and Microsoft System Center Operations Manager, ThinkServer Power Planner.			
	Operating systems supported	Microsoft Windows Server 2016/2012 R2/2012/2008 R2. Windows Small Business Server 2011. Red Hat Enterprise Linux 6.5/6.6/7. SUSE Linux Enterprise Server 11. VMware vSphere (ESXi) 5.1 P5/5.5 U2/6.0		
Base warranty	1 or 3-year limited onsite service with 9x5/NBD.			
Power supply	Up to two redundant hot-swap 450W/550W/750W/1100W power supplies. 450 W is 80 PLUS Gold qualified. 550W and 1100W are 80 PLUS Platinum qualified. 750W is 80 PLUS Platinum or Titanium qualified. 750W Titanium is 200V - 240V, others are 110V - 240V.			
	Disk bay configuration	PSU requirements		
	450W	550W	750W	1100W
	5x3.5" ES • (up to 1 CPU)	•	•	•
	5x3.5" HS • (up to 1 CPU)	•	•	•
15x3.5" HS	•	•	•	
8x2.5" HS • (up to 1 CPU)	•	•	•	
16x2.5" HS • (up to 1 CPU)	•	•	•	
32x2.5" HS	•	•	•	
Graphics	Onboard Aspeed AST2400 with 16MB memory, one VGA on rear			
Front ports	Two USB 2.0			
Rear ports	One VGA, four USB 3.0, one RJ-45 (dedicate/share mgmt), two ethernet (RJ-45), one serial (9-pin)			
Cooling	4 (3+1), hot-swap			
Noise emissions	Operating: < 6.5 Bels. Idle: < 6 Bels (Maximum configuration)			
Environmental specification	ASHRAE Class	A4	A3	A2
	Temperature - operating	41 °F to 113 °F (5 °C to 45 °C)	41 °F to 104 °F (5 °C to 40 °C)	50 °F to 95 °F (10 °C to 35 °C)
	Temperature - storage (with package)	-40 °C to 60 °C		
	Altitude - operating	(Unpressurized): 0-10000ft (0-3048m)		
	Humidity - operating (non-condensing)	8%~90%	8%~85%	20%~80%
Humidity - storage (with package)	8%~90%, non-condensing			
ASHRAE Class A4: ES or 8x2.5" HS bays/Lenovo-qualified CPU; maximum of 120W thermal design power; not low-power type (no L-suffix in the CPU name)/No internal tape/Two PSU installed for redundancy/Lenovo-qualified PCIe card; power consumption of each PCIe card does not exceed 15W. 32 x 2.5" models support ASHRAE Class A2, the other models support ASHRAE Class A3.				

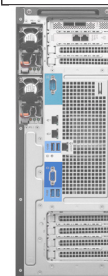

Expansion slots	
Slot 1 (CPU1)	PCIe 3.0 x16, full height, full length, double-wide
Slot 2 (CPU1)	PCIe 3.0 x16 (x8 elec), full height, full length
Slot 3 (CPU1)	PCIe 3.0 x16 (x8 elec), full height, full length
Slot 4 (CPU2)	PCIe 3.0 x16 (x8 elec), full height, full length
Slot 5 (CPU2)	PCIe 3.0 x16, full height, full length
Slot 6 (CPU2)	PCIe 3.0 x16 (x8 elec), full height, full length
Slot 7 (CPU2)	PCIe 3.0 x16 (x8 elec), full height, full length

For a list of all supported options, please see https://download.lenovo.com/pccbbs/options_iso/ocm_september_2016_thinkserver.xlsx sheet

Model	Region	Processor	2nd CPU	Memory	RAID Controller	Disk Bays	Storage	Optical	Add-on NIC	Add-on Ports	TPM	System Mgmt	OS	Warranty	Power Supply	Ann Date (m/y)
70DG0003UX	US	2xE5-2620 v3 6C/2.4GHz/15MB/85W/DDR4-1866	-	4x8GB RDIMM DDR4-2133 ECC	AnyRAID 110i+Key	5x3.5" HS	Open	HH DVD±RW	None	None	TPM 1.2	TSM	None	3-year	750Wx1 Platinum	09/14
70DG0007UX	US	1xE5-2603 v3 6C/1.6GHz/15MB/85W/DDR4-1600	4XG0F28787	1x8GB RDIMM DDR4-2133 ECC	AnyRAID 110i+Key	5x3.5" HS	Open	HH DVD±RW	None	None	TPM 1.2	TSM	None	3-year	550Wx1 Platinum	09/14
70DG0008UX	US	1xE5-2609 v3 6C/1.9GHz/15MB/85W/DDR4-1600	4XG0F28786	1x8GB RDIMM DDR4-2133 ECC	AnyRAID 110i+Key	5x3.5" HS	Open	HH DVD±RW	None	None	TPM 1.2	TSM	None	3-year	550Wx1 Platinum	09/14
70DG0009UX	US	1xE5-2620 v3 6C/2.4GHz/15MB/85W/DDR4-1866	4XG0F28785	1x8GB RDIMM DDR4-2133 ECC	AnyRAID 720ix+1GB RAM	15x3.5" HS	Open	HH DVD±RW	None	None	TPM 1.2	TSM	None	3-year	750Wx1 Platinum	09/14
70DG000AUX	US	1xE5-2640 v3 8C/2.6GHz/20MB/90W/DDR4-1866	4XG0F28783	1x8GB RDIMM DDR4-2133 ECC	AnyRAID 720ix+1GB RAM	15x3.5" HS	Open	HH DVD±RW	None	None	TPM 1.2	TSM	None	3-year	750Wx1 Platinum	09/14
70DG000BUX	US	1xE5-2650 v3 10C/2.3GHz/25MB/105W/DDR4-2133	4XG0F28782	1x8GB RDIMM DDR4-2133 ECC	AnyRAID 720ix+1GB RAM	15x3.5" HS	Open	HH DVD±RW	None	None	TPM 1.2	TSM	None	3-year	750Wx1 Platinum	09/14
70DG000CUX	US	1xE5-2670 v3 12C/2.3GHz/30MB/120W/DDR4-2133	4XG0F28780	1x8GB RDIMM DDR4-2133 ECC	AnyRAID 720ix+1GB RAM	15x3.5" HS	Open	HH DVD±RW	None	None	TPM 1.2	TSM	None	3-year	750Wx1 Platinum	09/14
70DG006NUX	US	1xE5-2603 v4 6C/1.7GHz/15MB/85W/DDR4-1866	4XG0G89088	1x16GB RDIMM DDR4-2400 ECC	Onboard 110i	5x3.5" HS	Open	None	None	None	TPM 1.2	TSM	None	3-year	750Wx1 Platinum	04/16
70DG006PUX	US	1xE5-2609 v4 8C/1.7GHz/20MB/85W/DDR4-1866	4XG0G89083	1x16GB RDIMM DDR4-2400 ECC	Onboard 110i	5x3.5" HS	Open	None	None	None	TPM 1.2	TSM	None	3-year	750Wx1 Platinum	04/16
70DG006QUX	US	1xE5-2620 v4 8C/2.1GHz/20MB/85W/DDR4-2133	4XG0G89078	1x16GB RDIMM DDR4-2400 ECC	Onboard 110i	5x3.5" HS	Open	None	None	None	TPM 1.2	TSM	None	3-year	750Wx1 Platinum	04/16
70DG006RUX	US	1xE5-2630 v4 10C/2.2GHz/20MB/85W/DDR4-2133	4XG0G89073	1x16GB RDIMM DDR4-2400 ECC	AnyRAID 720ix+1GB Flash	15x3.5" HS	Open	None	None	None	TPM 1.2	TSM	None	3-year	750Wx1 Platinum	04/16
70DG006SUX	US	1xE5-2640 v4 10C/2.4GHz/25MB/90W/DDR4-2133	4XG0G89068	1x16GB RDIMM DDR4-2400 ECC	AnyRAID 720ix+1GB Flash	15x3.5" HS	Open	None	None	None	TPM 1.2	TSM	None	3-year	750Wx1 Platinum	04/16
70DG006TUX	US	1xE5-2650 v4 12C/2.2GHz/30MB/105W/DDR4-2400	4XG0G89063	1x16GB RDIMM DDR4-2400 ECC	AnyRAID 720ix+1GB Flash	15x3.5" HS	Open	None	None	None	TPM 1.2	TSM	None	3-year	750Wx1 Platinum	04/16
70DG006UUX	US	1xE5-2660 v4 14C/2GHz/35MB/105W/DDR4-2400	4XG0G89058	1x16GB RDIMM DDR4-2400 ECC	AnyRAID 720ix+1GB Flash	15x3.5" HS	Open	None	None	None	TPM 1.2	TSM	None	3-year	750Wx1 Platinum	04/16
70DG006VUX	US	1xE5-2680 v4 14C/2.4GHz/35MB/120W/DDR4-2400	4XG0G89055	1x16GB RDIMM DDR4-2400 ECC	AnyRAID 720ix+1GB Flash	15x3.5" HS	Open	None	None	None	TPM 1.2	TSM	None	3-year	750Wx1 Platinum	04/16
70DG006WUX	US	2xE5-2620 v4 8C/2.1GHz/20MB/85W/DDR4-2133	-	2x16GB RDIMM DDR4-2400 ECC	AnyRAID 110i	5x3.5" HS	Open	None	None	None	TPM 1.2	TSM Premium	None	3-year	750Wx2 Platinum	04/16

Model	Region	Processor	2nd CPU	Memory	RAID Controller	Disk Bays	Storage	Optical	Add-on NIC	Add-on Ports	TPM	System Mgmt	OS	Warranty	Power Supply	Ann Date (m/y)
70DJ006NUX	US	1xE5-2640 v4 10C/2.4GHz/25MB/90W/DDR4-2133	4XG0G89068	1x16GB RDIMM DDR4-2400 ECC	AnyRAID 720i+1GB RAM	8x2.5" HS	Open	None	None	None	TPM 2.0	TSM	None	3-year	750Wx1 Platinum	04/16

ThinkServer TS150 Platform Specifications

Product Specifications Reference (PSREF)

Components	Specification																																										
Dimensions	Tower or 4U rack. Height: 375 mm (14.76 in), width: 175 mm (6.89 in), depth: 431 mm (16.97 in)																																										
Weight	Maximum configuration: 27.6 lb (12.5kg)																																										
Processor	Up to one Intel Xeon E3-1200 v5, Core i3, Pentium, or Celeron family processor.																																										
	<table border="1"> <tbody> <tr><td>Xeon E3-1280 v5</td><td>4C/3.7GHz/8MB/80W/DDR4-2133</td></tr> <tr><td>Xeon E3-1270 v5</td><td>4C/3.6GHz/8MB/80W/DDR4-2133</td></tr> <tr><td>Xeon E3-1240 v5</td><td>4C/3.5GHz/8MB/80W/DDR4-2133</td></tr> <tr><td>Xeon E3-1230 v5</td><td>4C/3.4GHz/8MB/80W/DDR4-2133</td></tr> <tr><td>Xeon E3-1220 v5</td><td>4C/3GHz/8MB/80W/DDR4-2133</td></tr> <tr><td>Xeon E3-1275 v5</td><td>4C/3.6GHz/8MB/80W/DDR4-2133</td></tr> <tr><td>Xeon E3-1245 v5</td><td>4C/3.5GHz/8MB/80W/DDR4-2133</td></tr> <tr><td>Xeon E3-1225 v5</td><td>4C/3.3GHz/8MB/80W/DDR4-2133</td></tr> <tr><td>Core i3-6320</td><td>2C/3.9GHz/4MB/51W/DDR4-2133</td></tr> <tr><td>Core i3-6300</td><td>2C/3.8GHz/4MB/51W/DDR4-2133</td></tr> <tr><td>Core i3-6300T</td><td>2C/3.3GHz/4MB/35W/DDR4-2133</td></tr> <tr><td>Core i3-6100</td><td>2C/3.7GHz/3MB/51W/DDR4-2133</td></tr> <tr><td>Core i3-6100T</td><td>2C/3.2GHz/3MB/35W/DDR4-2133</td></tr> <tr><td>Pentium G4520</td><td>2C/3.6GHz/3MB/51W/DDR4-2133</td></tr> <tr><td>Pentium G4500</td><td>2C/3.5GHz/3MB/51W/DDR4-2133</td></tr> <tr><td>Pentium G4500T</td><td>2C/3GHz/3MB/35W/DDR4-2133</td></tr> <tr><td>Pentium G4400</td><td>2C/3.3GHz/3MB/54W/DDR4-2133</td></tr> <tr><td>Pentium G4400T</td><td>2C/2.9GHz/3MB/35W/DDR4-2133</td></tr> <tr><td>Celeron G3920</td><td>2C/2.9GHz/2MB/51W/DDR4-2133</td></tr> <tr><td>Celeron G3900</td><td>2C/2.8GHz/2MB/51W/DDR4-2133</td></tr> <tr><td>Celeron G3900T</td><td>2C/2.6GHz/2MB/35W/DDR4-2133</td></tr> </tbody> </table>	Xeon E3-1280 v5	4C/3.7GHz/8MB/80W/DDR4-2133	Xeon E3-1270 v5	4C/3.6GHz/8MB/80W/DDR4-2133	Xeon E3-1240 v5	4C/3.5GHz/8MB/80W/DDR4-2133	Xeon E3-1230 v5	4C/3.4GHz/8MB/80W/DDR4-2133	Xeon E3-1220 v5	4C/3GHz/8MB/80W/DDR4-2133	Xeon E3-1275 v5	4C/3.6GHz/8MB/80W/DDR4-2133	Xeon E3-1245 v5	4C/3.5GHz/8MB/80W/DDR4-2133	Xeon E3-1225 v5	4C/3.3GHz/8MB/80W/DDR4-2133	Core i3-6320	2C/3.9GHz/4MB/51W/DDR4-2133	Core i3-6300	2C/3.8GHz/4MB/51W/DDR4-2133	Core i3-6300T	2C/3.3GHz/4MB/35W/DDR4-2133	Core i3-6100	2C/3.7GHz/3MB/51W/DDR4-2133	Core i3-6100T	2C/3.2GHz/3MB/35W/DDR4-2133	Pentium G4520	2C/3.6GHz/3MB/51W/DDR4-2133	Pentium G4500	2C/3.5GHz/3MB/51W/DDR4-2133	Pentium G4500T	2C/3GHz/3MB/35W/DDR4-2133	Pentium G4400	2C/3.3GHz/3MB/54W/DDR4-2133	Pentium G4400T	2C/2.9GHz/3MB/35W/DDR4-2133	Celeron G3920	2C/2.9GHz/2MB/51W/DDR4-2133	Celeron G3900	2C/2.8GHz/2MB/51W/DDR4-2133	Celeron G3900T	2C/2.6GHz/2MB/35W/DDR4-2133
	Xeon E3-1280 v5	4C/3.7GHz/8MB/80W/DDR4-2133																																									
	Xeon E3-1270 v5	4C/3.6GHz/8MB/80W/DDR4-2133																																									
	Xeon E3-1240 v5	4C/3.5GHz/8MB/80W/DDR4-2133																																									
	Xeon E3-1230 v5	4C/3.4GHz/8MB/80W/DDR4-2133																																									
	Xeon E3-1220 v5	4C/3GHz/8MB/80W/DDR4-2133																																									
	Xeon E3-1275 v5	4C/3.6GHz/8MB/80W/DDR4-2133																																									
	Xeon E3-1245 v5	4C/3.5GHz/8MB/80W/DDR4-2133																																									
	Xeon E3-1225 v5	4C/3.3GHz/8MB/80W/DDR4-2133																																									
	Core i3-6320	2C/3.9GHz/4MB/51W/DDR4-2133																																									
	Core i3-6300	2C/3.8GHz/4MB/51W/DDR4-2133																																									
	Core i3-6300T	2C/3.3GHz/4MB/35W/DDR4-2133																																									
	Core i3-6100	2C/3.7GHz/3MB/51W/DDR4-2133																																									
	Core i3-6100T	2C/3.2GHz/3MB/35W/DDR4-2133																																									
	Pentium G4520	2C/3.6GHz/3MB/51W/DDR4-2133																																									
	Pentium G4500	2C/3.5GHz/3MB/51W/DDR4-2133																																									
	Pentium G4500T	2C/3GHz/3MB/35W/DDR4-2133																																									
	Pentium G4400	2C/3.3GHz/3MB/54W/DDR4-2133																																									
	Pentium G4400T	2C/2.9GHz/3MB/35W/DDR4-2133																																									
Celeron G3920	2C/2.9GHz/2MB/51W/DDR4-2133																																										
Celeron G3900	2C/2.8GHz/2MB/51W/DDR4-2133																																										
Celeron G3900T	2C/2.6GHz/2MB/35W/DDR4-2133																																										
Chipset	Intel C236 Platform Controller Hub (PCH)																																										
Memory DIMMs	4 DIMM sockets with 2 channels, 2 DIMMs per channel. UDIMM . DDR4-2133																																										
Memory capacity	64GB (16GB x 4)																																										
Memory protection	ECC																																										
RAID controller	<table border="1"> <thead> <tr> <th>RAID controller</th> <th>Drive type</th> <th>RAID support</th> </tr> </thead> <tbody> <tr> <td>Onboard RAID12i1</td> <td>6Gbs SATA</td> <td>0/1/5/10</td> </tr> <tr> <td>RAID520i PCIe</td> <td>12Gbs SAS/SATA</td> <td>0/1/10, 5 with optional key</td> </tr> </tbody> </table>	RAID controller	Drive type	RAID support	Onboard RAID12i1	6Gbs SATA	0/1/5/10	RAID520i PCIe	12Gbs SAS/SATA	0/1/10, 5 with optional key																																	
	RAID controller	Drive type	RAID support																																								
Onboard RAID12i1	6Gbs SATA	0/1/5/10																																									
RAID520i PCIe	12Gbs SAS/SATA	0/1/10, 5 with optional key																																									
Disk bays	Supports up to four 3.5" or hybrid 3.5" + 2.5" disk drives , or up to five 2.5" disk drives. one 9.5mm optical (see right). Non-hot swap. Cables are connected to onboard SATA connectors or PCIe RAID controller. Supports one optional internal USB RDX Tape drive																																										
Supporting storage	<table border="1"> <tbody> <tr> <td>3.5" HDD, 7.2K SATA6Gbs</td> <td>500GB/1TB/2TB/3TB/4TB/5TB/6TB</td> </tr> <tr> <td>2.5" HDD, 7.2K SATA6Gbs</td> <td>500GB/1TB/2TB</td> </tr> <tr> <td>2.5" SSD, SATA6Gbs</td> <td>120GB/240GB/480GB/600GB/800GB/960GB</td> </tr> </tbody> </table>	3.5" HDD, 7.2K SATA6Gbs	500GB/1TB/2TB/3TB/4TB/5TB/6TB	2.5" HDD, 7.2K SATA6Gbs	500GB/1TB/2TB	2.5" SSD, SATA6Gbs	120GB/240GB/480GB/600GB/800GB/960GB																																				
	3.5" HDD, 7.2K SATA6Gbs	500GB/1TB/2TB/3TB/4TB/5TB/6TB																																									
	2.5" HDD, 7.2K SATA6Gbs	500GB/1TB/2TB																																									
2.5" SSD, SATA6Gbs	120GB/240GB/480GB/600GB/800GB/960GB																																										
SD module	Optional. Up to 2 SDHC flash cards via SD module, 8GB each																																										
Optical drive	Up to two half-height optical drives or one 9.5mm optical. DVD-ROM or DVD±RW																																										
Network interfaces	One Gigabit Ethernet port, Intel i219LM. Supports optional discrete network adapters via PCIe slots																																										
Security features	Power-on and administrator password. TPM (TCG 1.2-compliant)																																										
Systems management	UEFI, system LEDs, EasyStartup, EasyUpdate, Power Planner, and Diagnostics. Intel Active Management Technology 11 on models with Xeon processors. Intel Standard Manageability on models with Core i3, Pentium, or Celeron processors. KVM is supported on models with Xeon E3-12x5 v5 processors																																										
Operating systems	Microsoft Windows Server 2016/2012 R2/2012, Windows MultiPoint Server 2012, Windows 10 Pro. Red Hat Enterprise Linux 6.7/7.2. SUSE Linux Enterprise Server 11/12. VMware vSphere (ESXi) 5.5U3/6.0U2																																										
Base warranty	1 or 3-year limited onsite service with 9x5/NBD																																										
Power supply	Supports one of the following: <ul style="list-style-type: none"> One fixed 250 watts, autosensing, 85%, 80 PLUS Bronze qualified One fixed 400 watts, autosensing, 92%, 80 PLUS Platinum qualified 																																										
	<table border="1"> <thead> <tr> <th rowspan="2">CPU</th> <th colspan="4">Up to 80W</th> </tr> <tr> <th colspan="2">Not supported</th> <th colspan="2">Support</th> </tr> </thead> <tbody> <tr> <td>Discrete graphics adapter</td> <td></td> <td></td> <td></td> <td></td> </tr> <tr> <td>Disk drives</td> <td>2 x 3.5"</td> <td>4 x 3.5" + 1 x 2.5"</td> <td>2 x 3.5"</td> <td>4 x 3.5" + 1 x 2.5"</td> </tr> <tr> <td>250W fixed PSU</td> <td>•</td> <td>•</td> <td>•</td> <td>•</td> </tr> <tr> <td>400W fixed PSU</td> <td>•</td> <td>•</td> <td>•</td> <td>•</td> </tr> </tbody> </table>	CPU	Up to 80W				Not supported		Support		Discrete graphics adapter					Disk drives	2 x 3.5"	4 x 3.5" + 1 x 2.5"	2 x 3.5"	4 x 3.5" + 1 x 2.5"	250W fixed PSU	•	•	•	•	400W fixed PSU	•	•	•	•													
	CPU		Up to 80W																																								
		Not supported		Support																																							
	Discrete graphics adapter																																										
Disk drives	2 x 3.5"	4 x 3.5" + 1 x 2.5"	2 x 3.5"	4 x 3.5" + 1 x 2.5"																																							
250W fixed PSU	•	•	•	•																																							
400W fixed PSU	•	•	•	•																																							

Components	Specification	
Graphics	Integrated Intel HD Graphics on Xeon E3-12x5 v5, Core i3, Pentium, and Celeron processors. Uses main memory, works along with discrete graphics to support multi-display, enables two display connectors (1 DP, 1 VGA) on rear ports. Also supports the following discrete graphics adapter options: <ul style="list-style-type: none"> NVIDIA Quadro NVS 315, 1GB NVIDIA Quadro K620, 2GB 	
HD Audio	Realtek ALC662 codec	
Front ports	Two USB 3.0	
Rear ports	One VGA, one DisplayPort, six USB 3.0, one RJ-45, one serial (9-pin), three analog audio ports (line-in, line-out, mic-in). Optional parallel or serial ports via PCIe adapters	
Noise emissions	Operating: < 35 dB(A). Idle: < 34 dB(A) (Maximum configuration)	
Environmental specification	Temperature - operating	50 °F to 95 °F (10 °C to 35 °C)
	Temperature - non operating (with package)	-40 °C to 60 °C
	Altitude - operating	(Unpressurized): 0-10000ft (0-3048m)
	Humidity - operating	8%-80%, non-condensing
	Humidity - storage (with package)	10%-90%, non-condensing

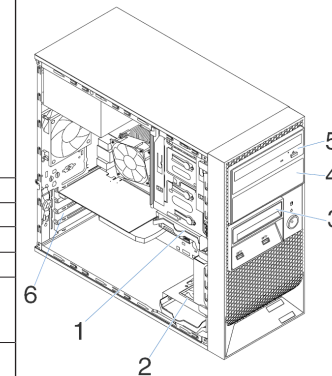

Disk Bays and PCIe Slots

Disk bays configuration	4 x 3.5"	4 x 2.5"	4 x hybrid 3.5" + 2.5"
Bay 1	1st HDD bay	1st HDD bay	1st HDD bay, 3.5"/2.5"
Bay 2	2nd HDD bay	2nd HDD bay	2nd HDD bay, 3.5"/2.5"
Bay 3	Not supported	3rd HDD bay	Not supported on standard models. Supports one 2.5" disk drive for special bid only
Bay 4	2nd half-height optical, or RDX tape drive, or 3rd HDD bay	2nd half-height optical, or RDX tape drive, or 4th HDD bay	2nd half-height optical, or RDX tape drive, or 3rd HDD bay (3.5"/2.5")
Bay 5	1st half-height optical, or 9.5mm optical + 4th HDD bay	1st half-height optical, or 9.5mm optical +5th HDD bay	1st half-height optical, or 9.5mm optical + 4th HDD bay (3.5"/2.5")
6	Four PCIe slots (top-down): Slot 1: PCIe 3.0 x16, full height, half length (near CPU) Slot 2: PCIe 3.0 x1, full height, half length Slot 3: PCIe 3.0 x16 (x4 elec), full height, half length Slot 4: PCIe 3.0 x1, full height, half length		

Model	Region	Processor	Memory	RAID Controller	Disk Bays	Storage	Optical	Add-on NIC	Add-on Ports	System Mgmt	OS	Warranty	Power Supply	Ann Date (m/y)
70LV002XUX	US	Xeon E3-1225 v5 4C/3.3GHz/8MB/80W/DDR4-2133	1x8GB UDIMM DDR4-2133 ECC	RAID 121i	5x2.5" DC	Open	None	None	None	AMT	None	1-year	250W 85% Fixed	08/16
70LV002YUX	US	Xeon E3-1245 v5 4C/3.5GHz/8MB/80W/DDR4-2133	1x8GB UDIMM DDR4-2133 ECC	RAID 121i	5x2.5" DC	Open	None	None	None	AMT	None	1-year	250W 85% Fixed	08/16
70LV0030UX	US	Xeon E3-1275 v5 4C/3.6GHz/8MB/80W/DDR4-2133	1x8GB UDIMM DDR4-2133 ECC	RAID 121i	5x2.5" DC	Open	None	None	None	AMT	None	1-year	250W 85% Fixed	08/16
70LV0031UX	US	Xeon E3-1225 v5 4C/3.3GHz/8MB/80W/DDR4-2133	1x8GB UDIMM DDR4-2133 ECC	RAID 121i	4x3.5" DC	Open	None	None	None	AMT	None	1-year	250W 85% Fixed	08/16
70LV0032UX	US	Xeon E3-1245 v5 4C/3.5GHz/8MB/80W/DDR4-2133	1x8GB UDIMM DDR4-2133 ECC	RAID 121i	4x3.5" DC	Open	None	None	None	AMT	None	1-year	250W 85% Fixed	08/16
70LV0033UX	US	Xeon E3-1275 v5 4C/3.6GHz/8MB/80W/DDR4-2133	1x8GB UDIMM DDR4-2133 ECC	RAID 121i	4x3.5" DC	Open	None	None	None	AMT	None	1-year	250W 85% Fixed	08/16
70LV0034UX	US	Core i3-6100T 2C/3.2GHz/3MB/35W/DDR4-2133	1x8GB UDIMM DDR4-2133 ECC	RAID 121i	4x3.5" DC/3 available	Open	HH DVD±RW	None	None	ISM	None	1-year	250W 85% Fixed	08/16
70LV0035UX	US	Core i3-6100T 2C/3.2GHz/3MB/35W/DDR4-2133	1x8GB UDIMM DDR4-2133 ECC	RAID 121i	4x3.5" DC	Open	None	None	None	ISM	None	1-year	250W 85% Fixed	08/16
70LV0036UX	US	Xeon E3-1225 v5 4C/3.3GHz/8MB/80W/DDR4-2133	1x8GB UDIMM DDR4-2133 ECC	RAID 121i	4x3.5" DC	Open	9.5mm DVD±RW	None	None	AMT	None	1-year	250W 85% Fixed	08/16
70LV0037UX	US	Xeon E3-1245 v5 4C/3.5GHz/8MB/80W/DDR4-2133	1x8GB UDIMM DDR4-2133 ECC	RAID 121i	4x3.5" DC	Open	9.5mm DVD±RW	None	None	AMT	None	1-year	250W 85% Fixed	08/16
70LV0038UX	US	Xeon E3-1275 v5 4C/3.6GHz/8MB/80W/DDR4-2133	1x8GB UDIMM DDR4-2133 ECC	RAID 121i	4x3.5" DC	Open	9.5mm DVD±RW	None	None	AMT	None	1-year	250W 85% Fixed	08/16
70LV0039UX	US	Xeon E3-1225 v5 4C/3.3GHz/8MB/80W/DDR4-2133	1x8GB UDIMM DDR4-2133 ECC	RAID 121i	5x2.5" DC	Open	9.5mm DVD±RW	None	None	AMT	None	1-year	250W 85% Fixed	08/16
70LV003AUX	US	Xeon E3-1245 v5 4C/3.5GHz/8MB/80W/DDR4-2133	1x8GB UDIMM DDR4-2133 ECC	RAID 121i	5x2.5" DC	Open	9.5mm DVD±RW	None	None	AMT	None	1-year	250W 85% Fixed	08/16
70LV003BUX	US	Xeon E3-1275 v5 4C/3.6GHz/8MB/80W/DDR4-2133	1x8GB UDIMM DDR4-2133 ECC	RAID 121i	5x2.5" DC	Open	9.5mm DVD±RW	None	None	AMT	None	1-year	250W 85% Fixed	08/16

ThinkServer TS150 - TopSeller - 70LX

Product Specifications Reference (PSREF)

Model	Region	Processor	Memory	RAID Controller	Disk Bays	Storage	Optical	Add-on NIC	Add-on Ports	System Mgmt	OS	Warranty	Power Supply	Ann Date (m/y)
70LX0017UX	US	Xeon E3-1275 v5 4C/3.6GHz/8MB/80W/DDR4-2133	1x8GB UDIMM DDR4-2133 ECC	RAID 121i	4x3.5" DC	Open	None	None	None	AMT	None	1-year	400W 92% Fixed	08/16
70LX0018UX	US	Xeon E3-1275 v5 4C/3.6GHz/8MB/80W/DDR4-2133	1x8GB UDIMM DDR4-2133 ECC	RAID 121i	5x2.5" DC	Open	None	None	None	AMT	None	1-year	400W 92% Fixed	08/16



ThinkServer TS440 Platform Specifications

Components	Specification																							
Dimensions	Tower or 5U rack. Height: 430 mm (16.9 in), width: 195 mm (7.68 in), depth: 595 mm (23.4 in)																							
Weight	Maximum configuration: 61.7 lb (28kg)																							
Processor	Supports one of the following Intel processors (code name: Haswell): • Xeon E3-1200 v3: up to 4C/3.7GHz/8MB/84W/1600MHz																							
Chipset	Intel C226 Platform Controller Hub (PCH)																							
Memory DIMMs	4 DIMM sockets, 2-channel capable. UDIMM, DDR3, up to 1600MHz																							
Memory capacity	32GB																							
Memory protection	ECC																							
RAID controller	Supports one of the following onboard or PCIe RAID adapters: • RAID 0, 1, 5, 10 with onboard RAID 100, 6Gb/s SATA. • RAID 0, 1, 10 with RAID 500, PCIe adapter, 6Gb/s SAS/SATA, optional key for RAID5/50. • RAID 0, 1, 5, 6, 10, 50, 60 with RAID 700, PCIe adapter, 6Gb/s SAS/SATA, optional Intelligent Battery Backup Unit (iBBU08). <i>Note: RAID 50 and 60 are supported on 8 hard drive bays models only.</i>																							
Disk drive bays	Up to 4 3.5" disk bays, non-hot swap, direct cable. Or up to 8 3.5" disk bays, hot-swap. Or up to 8 2.5" disk bays, hot-swap. On front. Supports internal RDX tape drive, consumes 5.25" bay, also supports optional external USB RDX tape drive. <table border="1" data-bbox="283 581 919 695"> <thead> <tr> <th rowspan="2">Disk bay configuration</th> <th colspan="3">RAID controller requirements and optional drives supported</th> </tr> <tr> <th>RAID100</th> <th>RAID500</th> <th>RAID700</th> </tr> </thead> <tbody> <tr> <td>4x3.5" non-hot swap</td> <td>•</td> <td></td> <td></td> </tr> <tr> <td>4x3.5" HS</td> <td>•</td> <td>•</td> <td>•</td> </tr> <tr> <td>8x3.5" HS</td> <td></td> <td>•</td> <td>•</td> </tr> <tr> <td>8x2.5" HS</td> <td></td> <td>•</td> <td>•</td> </tr> </tbody> </table>	Disk bay configuration	RAID controller requirements and optional drives supported			RAID100	RAID500	RAID700	4x3.5" non-hot swap	•			4x3.5" HS	•	•	•	8x3.5" HS		•	•	8x2.5" HS		•	•
Disk bay configuration	RAID controller requirements and optional drives supported																							
	RAID100	RAID500	RAID700																					
4x3.5" non-hot swap	•																							
4x3.5" HS	•	•	•																					
8x3.5" HS		•	•																					
8x2.5" HS		•	•																					
Maximum internal storage	3.5" non-hot swap model: up to 24TB with 7.2K SATA HDD. 3.5" hot swap model: up to 48TB with 7.2K SATA HDD, up to 32TB with 7.2K SAS HDD, up to 4.8TB with 15K SAS HDD, up to 2.4TB with SATA SSD 2.5" hot swap model: up to 8TB with 7.2K SATA HDD, up to 7.2TB with 10K SAS HDD, up to 4.8TB with 15K SAS HDD, up to 2.4TB with SATA SSD <i>Note: Supports up to 4 SSD drives.</i>																							
Optical drive	Two 5.25" bays for optical. DVD-ROM or DVD±RW. Half-height																							
Network interfaces	One onboard gigabit ethernet, Intel I217, shared with AMT. Supports optional discrete network adapters via PCIe slots																							
Security features	Power-on and administrator password. TPM (TCG 1.2-compliant). Optional padlock loop, Kensington cable lock																							
Systems management	Intel Active Management Technology 9 on models with Xeon processor. Remote presence is supported on models with Xeon E3-12x5 v3 or E3-12x6 v3 processor																							
Operating systems supported	Microsoft Windows Server 2016/2012 R2/2012/2008 R2. Windows Small Business Server 2011. Windows 8.1/8/7(except Home edition). Red Hat Enterprise Linux 6.4/6.5/6.7/7/7.1. SUSE Linux Enterprise Server 11/12. VMware vSphere (ESXi) 5.1 U1/5.1 U2/5.5/5.5 U1/5.5 U2/5.5 U3, Citrix Xen server 6.2 <i>Note: VMware requires processors with Intel HD, add-on network adapters, and PCIe RAID adapters.</i>																							

Components	Specification	
Base warranty	1 or 3-year limited onsite service with 9x5/NBD.	
Power supply	Supports one of the following, depending on models: • One fixed 450 watts, universal, 80 PLUS Platinum qualified. • Up to two redundant 450 watts, two maximum, rear access, hot-swap, 80 PLUS Gold qualified, redundant with two power supplies	
Graphics	Integrated Intel HD Graphics on Xeon E3-12x6 v3, Xeon E3-12x5 v3 processors. Uses main memory, works along with discrete graphics to support multi-display, enables one VGA connector on rear. Also supports the following optional discrete graphics adapters: • NVIDIA Quadro NVS 300, PCIe adapter, 512MB • NVIDIA Quadro NVS 315, PCIe adapter, 1GB	
Front ports	Two USB 3.0 (blue)	
Rear ports	One VGA for models with Intel HD Graphics, two USB 2.0, four USB 3.0 (blue), one serial (9-pin), one ethernet (RJ-45). Optional parallel or serial ports via PCI or PCIe adapters	
Noise emissions	Operating: < 42 dB(A). Idle: < 38 dB(A) (Maximum configuration)	
Environmental specification	GREENGUARD certified, Energy Star Server 1.1 qualified, RoHS-compliant	
	Temperature - operating	50 °F to 95 °F (10 °C to 35 °C)
	Temperature - storage (with package)	-40 °C to 70 °C
	Altitude - operating	Supported Altitude (unpressurized): 0-10000ft (0-3048m)
	Humidity - operating	10%-80%, non-condensing
	Humidity - storage (with package)	10%-90%, non-condensing

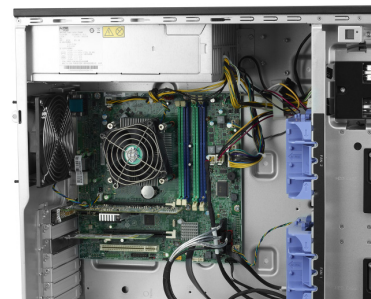

Expansion slots

- Four PCIe slots (top-down):
Slot 1: PCIe 3.0 x16, full height, half length (near CPU)
Slot 2: PCIe 3.0 x1, full height, half length
Slot 3: PCIe 2.0 x16 (x4 elec), full height, half length
Slot 4: PCI 2.3, full height, half length
Note: All PCI/PCIe adapters are optional.

ThinkServer TS440 - TopSeller - 70AN

Product Specifications Reference (PSREF)

Model	Region	Processor	Memory	RAID Controller	Disk Bays	Storage	Optical	Add-on NIC	System Mgmt	OS	Warranty	Power Supply	Ann Date (m/y)
70AN0001UX	US	Xeon E3-1225 v3 4C/3.2GHz/8MB/84W/DDR3-1600	1x4GB UDIMM DDR3-1600 ECC	RAID 100	4x3.5" HS	Open	HH DVD	None	AMT9	None	1-year	450W Platinum Fixed	09/13
70AN0002UX	US	Xeon E3-1225 v3 4C/3.2GHz/8MB/84W/DDR3-1600	1x4GB UDIMM DDR3-1600 ECC	RAID 100	4x3.5" HS	Open	HH DVD	None	AMT9	None	3-year	450W Platinum Fixed	09/13
70AN000KUX	US	Xeon E3-1226 v3 4C/3.3GHz/8MB/84W/DDR3-1600	1x4GB UDIMM DDR3-1600 ECC	RAID 100	4x3.5" HS	Open	HH DVD	None	AMT9	None	1-year	450W Platinum Fixed	09/14

Model	Region	Processor	Memory	RAID Controller	Disk Bays	Storage	Optical	Add-on NIC	System Mgmt	OS	Warranty	Power Supply	Ann Date (m/y)
70AQ0005US	US	Xeon E3-1225 v3 4C/3.2GHz/8MB/84W/DDR3-1600	1x4GB UDIMM DDR3-1600 ECC	RAID 100	4x3.5" HS	2x500GB HDD 7.2K 3.5" SATA6Gbs	HH DVD±RW	None	AMT9	2012 Foundations	3-year	450Wx1 Gold	09/13
70AQ0006US	US	Xeon E3-1225 v3 4C/3.2GHz/8MB/84W/DDR3-1600	1x4GB UDIMM DDR3-1600 ECC	RAID 100	4x3.5" HS	2x500GB HDD 7.2K 3.5" SATA6Gbs	HH DVD±RW	None	AMT9	2012 Essentials	3-year	450Wx1 Gold	09/13
70AQ0007US	US	Xeon E3-1225 v3 4C/3.2GHz/8MB/84W/DDR3-1600	1x4GB UDIMM DDR3-1600 ECC	RAID 100	4x3.5" HS	2x500GB HDD 7.2K 3.5" SATA6Gbs	HH DVD±RW	None	AMT9	2012 Standard	3-year	450Wx1 Gold	09/13
70AQ0009UX	US	Xeon E3-1225 v3 4C/3.2GHz/8MB/84W/DDR3-1600	1x4GB UDIMM DDR3-1600 ECC	RAID 100	4x3.5" HS	Open	HH DVD±RW	None	AMT9	None	1-year	450Wx1 Gold	09/13
70AQ000AUX	US	Xeon E3-1225 v3 4C/3.2GHz/8MB/84W/DDR3-1600	1x4GB UDIMM DDR3-1600 ECC	RAID 100	4x3.5" HS	Open	HH DVD±RW	None	AMT9	None	3-year	450Wx1 Gold	09/13
70AQ000BUX	US	Xeon E3-1245 v3 4C/3.4GHz/8MB/84W/DDR3-1600	1x4GB UDIMM DDR3-1600 ECC	RAID 100	4x3.5" HS	Open	HH DVD±RW	None	AMT9	None	3-year	450Wx1 Gold	09/13
70AQ000CUX	US	Xeon E3-1245 v3 4C/3.4GHz/8MB/84W/DDR3-1600	1x4GB UDIMM DDR3-1600 ECC	RAID 500	8x3.5" HS	Open	HH DVD±RW	None	AMT9	None	3-year	450Wx1 Gold	09/13
70AQ000DUX	US	Xeon E3-1225 v3 4C/3.2GHz/8MB/84W/DDR3-1600	1x4GB UDIMM DDR3-1600 ECC	RAID 500	8x3.5" HS	Open	HH DVD±RW	None	AMT9	None	3-year	450Wx1 Gold	09/13
70AQ000EUX	US	Xeon E3-1225 v3 4C/3.2GHz/8MB/84W/DDR3-1600	1x4GB UDIMM DDR3-1600 ECC	RAID 500	8x2.5" HS	Open	HH DVD±RW	None	AMT9	None	3-year	450Wx1 Gold	09/13
70AQ000FUX	US	Xeon E3-1245 v3 4C/3.4GHz/8MB/84W/DDR3-1600	1x4GB UDIMM DDR3-1600 ECC	RAID 500	8x2.5" HS	Open	HH DVD±RW	None	AMT9	None	3-year	450Wx1 Gold	09/13
70AQ000GUX	US	Xeon E3-1275 v3 4C/3.5GHz/8MB/84W/DDR3-1600	1x4GB UDIMM DDR3-1600 ECC	RAID 100	4x3.5" HS	Open	HH DVD±RW	None	AMT9	None	3-year	450Wx1 Gold	09/13
70AQ000HUX	US	Xeon E3-1225 v3 4C/3.2GHz/8MB/84W/DDR3-1600	1x4GB UDIMM DDR3-1600 ECC	RAID 700	8x3.5" HS	Open	HH DVD±RW	None	AMT9	None	3-year	450Wx1 Gold	09/13
70AQ000NUX	US	Xeon E3-1225 v3 4C/3.2GHz/8MB/84W/DDR3-1600	1x4GB UDIMM DDR3-1600 ECC	RAID 500	4x3.5" HS	Open	HH DVD	None	AMT9	None	1-year	450Wx1 Gold	09/13
70AQ000PUX	US	Xeon E3-1225 v3 4C/3.2GHz/8MB/84W/DDR3-1600	1x4GB UDIMM DDR3-1600 ECC	RAID 500	4x3.5" HS	Open	HH DVD	None	AMT9	None	3-year	450Wx1 Gold	09/13
70AQ000XUX	US	Xeon E3-1225 v3 4C/3.2GHz/8MB/84W/DDR3-1600	1x4GB UDIMM DDR3-1600 ECC	RAID 500	8x3.5" HS	Open	HH DVD±RW	None	AMT9	None	1-year	450Wx1 Gold	05/14
70AQ000YUX	US	Xeon E3-1245 v3 4C/3.4GHz/8MB/84W/DDR3-1600	1x4GB UDIMM DDR3-1600 ECC	RAID 500	8x3.5" HS	Open	HH DVD±RW	None	AMT9	None	1-year	450Wx1 Gold	05/14
70AQ001JUX	US	Xeon E3-1226 v3 4C/3.3GHz/8MB/84W/DDR3-1600	1x4GB UDIMM DDR3-1600 ECC	RAID 100	4x3.5" HS	Open	HH DVD±RW	None	AMT9	None	1-year	450Wx1 Gold	09/14

Model	Region	Processor	Memory	RAID Controller	Disk Bays	Storage	Optical	Add-on NIC	System Mgmt	OS	Warranty	Power Supply	Ann Date (m/y)
70AQ001KUX	US	Xeon E3-1226 v3 4C/3.3GHz/8MB/84W/DDR3-1600	1x4GB UDIMM DDR3-1600 ECC	RAID 500	8x3.5" HS	Open	HH DVD±RW	None	AMT9	None	1-year	450Wx1 Gold	09/14
70AQ001LUX	US	Xeon E3-1226 v3 4C/3.3GHz/8MB/84W/DDR3-1600	1x4GB UDIMM DDR3-1600 ECC	RAID 100	4x3.5" HS	Open	HH DVD	None	AMT9	None	1-year	450Wx1 Gold	09/14
70AQ001MUS	US	Xeon E3-1226 v3 4C/3.3GHz/8MB/84W/DDR3-1600	1x4GB UDIMM DDR3-1600 ECC	RAID 100	4x3.5" HS	2x500GB HDD 7.2K 3.5" SATA6Gbs	HH DVD±RW	None	AMT9	2012 R2 Foundations	1-year	450Wx1 Gold	09/14
70AQ001NUS	US	Xeon E3-1226 v3 4C/3.3GHz/8MB/84W/DDR3-1600	1x4GB UDIMM DDR3-1600 ECC	RAID 100	4x3.5" HS	2x500GB HDD 7.2K 3.5" SATA6Gbs	HH DVD±RW	None	AMT9	2012 R2 Essentials	1-year	450Wx1 Gold	09/14
70AQ001PUS	US	Xeon E3-1226 v3 4C/3.3GHz/8MB/84W/DDR3-1600	1x4GB UDIMM DDR3-1600 ECC	RAID 100	4x3.5" HS	2x500GB HDD 7.2K 3.5" SATA6Gbs	HH DVD±RW	None	AMT9	2012 R2 Standard	1-year	450Wx1 Gold	09/14
70AQ001QUX	US	Xeon E3-1246 v3 4C/3.5GHz/8MB/84W/DDR3-1600	1x4GB UDIMM DDR3-1600 ECC	RAID 100	4x3.5" HS	Open	HH DVD±RW	None	AMT9	None	1-year	450Wx1 Gold	09/14
70AQ001RUX	US	Xeon E3-1246 v3 4C/3.5GHz/8MB/84W/DDR3-1600	1x4GB UDIMM DDR3-1600 ECC	RAID 500	8x3.5" HS	Open	HH DVD±RW	None	AMT9	None	1-year	450Wx1 Gold	09/14
70AQ001SUX	US	Xeon E3-1246 v3 4C/3.5GHz/8MB/84W/DDR3-1600	1x4GB UDIMM DDR3-1600 ECC	RAID 500	8x2.5" HS	Open	HH DVD±RW	None	AMT9	None	1-year	450Wx1 Gold	09/14
70AQ001TUX	US	Xeon E3-1276 v3 4C/3.6GHz/8MB/84W/DDR3-1600	1x4GB UDIMM DDR3-1600 ECC	RAID 700	8x3.5" HS	Open	HH DVD±RW	None	AMT9	None	1-year	450Wx1 Gold	09/14
70AQ001UUX	US	Xeon E3-1276 v3 4C/3.6GHz/8MB/84W/DDR3-1600	1x4GB UDIMM DDR3-1600 ECC	RAID 700	8x2.5" HS	Open	HH DVD±RW	None	AMT9	None	1-year	450Wx1 Gold	09/14

Model	Region	Processor	Memory	RAID Controller	Disk Bays	Storage	Optical	Add-on NIC	System Mgmt	OS	Warranty	Power Supply	Ann Date (m/y)
70AL0000US	US	Xeon E3-1225 v3 4C/3.2GHz/8MB/84W/DDR3-1600	3x8GB UDIMM DDR3-1600 ECC	RAID 100	4x3.5" HS	3x3TB HDD 7.2K 3.5" SATA6Gbs	HH DVD±RW	2xGbE	AMT9	2012 Foundations	1-year	450W Platinum Fixed	09/13
70AL0001US	US	Xeon E3-1245 v3 4C/3.4GHz/8MB/84W/DDR3-1600	1x4GB UDIMM DDR3-1600 ECC	RAID 500	8x2.5" HS	1x500GB HDD 7.2K 2.5" SATA6Gbs	2xHH DVD±RW	4xGbE	AMT9	2012 Foundations	1-year	450W Platinum Fixed	09/13
70AL0002UX	US	Xeon E3-1225 v3 4C/3.2GHz/8MB/84W/DDR3-1600	1x4GB UDIMM DDR3-1600 ECC	RAID 100	4x3.5" HS	1x500GB HDD 7.2K 3.5" SATA6Gbs	HH DVD	None	AMT9	None	3-year	450W Platinum Fixed	09/13
70AL0003UX	US	Xeon E3-1225 v3 4C/3.2GHz/8MB/84W/DDR3-1600	1x4GB UDIMM DDR3-1600 ECC	RAID 100	4x3.5" HS	Open	HH DVD	None	AMT9	None	3-year	450W Platinum Fixed	09/13

Model	Region	Processor	Memory	RAID Controller	Disk Bays	Storage	Optical	Add-on NIC	System Mgmt	OS	Warranty	Power Supply	Ann Date (m/y)
70AM0000US	US	Xeon E3-1225 v3 4C/3.2GHz/8MB/84W/DDR3-1600	2x2GB UDIMM DDR3-1600 ECC	RAID 100	4x3.5" DC	2x500GB HDD 7.2K 3.5" SATA6Gbs	HH DVD	1xGbE	AMT9	2012 Foundations	1-year	450Wx1 Gold	09/13
70AM0001US	US	Xeon E3-1275 v3 4C/3.5GHz/8MB/84W/DDR3-1600	4x2GB UDIMM DDR3-1600 ECC	RAID 500+Key	8x3.5" HS	8x2TB HDD 7.2K 3.5" SATA6Gbs	2xHH DVD±RW	1xGbE	AMT9	2012 Foundations	1-year	450Wx2 Gold	09/13
70AM0002UX	US	Xeon E3-1280 v3 4C/3.6GHz/8MB/82W/DDR3-1600	3x4GB UDIMM DDR3-1600 ECC	RAID 700	8x2.5" HS	3x600GB HDD 10K 2.5" SAS6Gbs	HH DVD	4xGbE	AMT9	None	1-year	450Wx1 Gold	09/13
70AM0003US	US	Xeon E3-1285 v3 4C/3.6GHz/8MB/84W/DDR3-1600	4x8GB UDIMM DDR3-1600 ECC	RAID 700	8x2.5" HS	8x900GB HDD 10K 2.5" SAS6Gbs	HH DVD±RW	2xGbE	AMT9	2012 Foundations	1-year	450Wx2 Gold	09/13
70AM0004UX	US	Xeon E3-1225 v3 4C/3.2GHz/8MB/84W/DDR3-1600	1x4GB UDIMM DDR3-1600 ECC	RAID 100	4x3.5" HS	Open	HH DVD	None	AMT9	None	3-year	450Wx1 Gold	09/13

Availability: All offers subject to availability. Lenovo reserves the right to alter product offerings and specifications at any time, without notice. Lenovo is not responsible for photographic or typographic errors.

Warranty: For a copy of applicable product warranties, write to: Warranty Support Dept., EMEA Services, Lenovo, Eisteinova 21, 851 01 Bratislava, Slovakia. Lenovo makes no representation or warranty regarding third party products or services.

- ¹ **Limited warranty:** Support unrelated to a warranty issue may be subject to additional charges.
- ² **Hard drive:** GB = billion bytes, TB = trillion bytes. Accessible capacity is less.
- ³ **Systems with limited onsite service** are designed to be repaired during the applicable warranty period primarily with customer-replaceable parts provided by Lenovo. Lenovo will only send a technician onsite to perform a repair if (a) remote telephone diagnosis and/or customer part replacement are unable to resolve the problem, or (b) the part is one of the few designated by Lenovo for onsite replacement. For a list of onsite replaceable parts, contact Lenovo. Support unrelated to a warranty issue may be subject to additional charges. Support phone list available at www-307.ibm.com/pc/support/site.wss/document.do?Indocid=MIGR-70552
- ⁴ **SATA/SAS:** The system configuration supports the installation of either SATA or SAS disks. A configuration including both SATA and SAS disks is not supported.
- ⁷ **Lenovo Services:** These services are available for machines normally used for business, professional, or trade purposes, rather than personal, family, or household purposes. Not all machine types and models are covered. Service period begins with the equipment date of purchase. Service must be purchased during the original limited product warranty period. Service levels are response time objectives and are not guarantees. If the machine problem turns out to be a Customer Replaceable Unit (CRU), a part will be express shipped to you for quick replacement. See Lenovo Warranty Services terms and conditions for complete details and restrictions.

⁸ **RAID:** Supported RAID levels for a system will vary from the stated capabilities of the RAID controller due to dependencies on the number and capacity of physical disks in the system and on customer requirements for performance, fault tolerance, or data redundancy.

RAID levels and requirements:

- **RAID 0 (striping)** provides increased performance by writing data across multiple drives.
- **RAID 1 (mirroring)** provides fault tolerance by writing the data on two drives.
- **RAID 5 (striping with parity)** uses distributed parity data to provide fault tolerance more efficiently than RAID 1. Requires three or more drives.
- **RAID 6 (striped set with dual distributed parity)** provides fault tolerance from two drive failures; array continues to operate with up to two failed drives. Requires four drives.
- **RAID 10 (or RAID 1+0)** combines RAID 1 and RAID 0 to create a stripe of mirrors that is fault tolerant while offering increased performance. Requires four drives.
- **RAID 50 (or RAID 5+0)** combines RAID 5 and RAID 0 to create block-level striping with distributed parity improving performance over RAID 5. Requires six drives.
- **RAID 60 (or RAID 6+0)** combines RAID 6 and RAID 0 to create block-level striping with distributed double parity improving performance over RAID 6. Requires eight drives.

¹⁴ **Response times may vary.** Response time is an average target and omitted service level. May exclude some holidays. Telephone support may be subject to additional charges.

ThinkServer™

This publication was developed for products and services offered in Europe, Middle East, and Africa. Lenovo may not offer the products, services or features discussed in this document in other countries. Lenovo may withdraw an offering at any time. Information is subject to change without notice. Consult your local representative for information on offerings available in your area.

Lenovo reserves the right to change specifications and other product information at any time without prior notice. Lenovo is not responsible for photographic or typographical errors. LENOVO PROVIDES THIS PUBLICATION "AS IS" WITHOUT WARRANTY OF ANY KIND, EITHER EXPRESS OR IMPLIED, INCLUDING THE IMPLIED WARRANTIES OF MERCHANTABILITY OR FITNESS FOR A PARTICULAR PURPOSE. Some jurisdictions do not allow disclaimer of express or implied warranties in certain transactions; therefore this disclaimer may not apply to you.

Trademarks: Lenovo, the Lenovo logo, New World, New Thinking., Access Connections, Rescue and Recovery, ThinkCentre, ThinkPad, ThinkServer, ThinkStation, ThinkVantage, and ThinkVision are trademarks of Lenovo. Microsoft, Windows, and Vista are registered trademarks of Microsoft Corporation. Intel, the Intel logo, Intel Inside logo, Intel Core and Core Inside are trademarks of Intel Corporation in the US and other countries. Other company, product, or service names may be trademarks or service marks of others.

Visit www.lenovo.com/safecomputing periodically for the latest information on safe and effective computing.

Visit www.lenovo.com/psref for the latest version of Product Specifications Reference.

© Lenovo
All rights reserved.

Lenovo
1009 Think Place
Morrisville, NC 27560
U.S.A.

LenovoTM

ThinkVision

PSREF



Product Specifications Reference

Version 501, January 2017

U.S.

Visit <http://psref.lenovo.com> for the latest version

Contents

Cover		
Contents		
Summary Of Change		
17 Inch - 20 Inch		
ThinkVision E1922s		
ThinkVision E1922s Platform Specifications		
ThinkVision E2054		
ThinkVision E2054 Platform Specifications		
ThinkVision LT1913p Square		
ThinkVision LT1913p Square Platform Specifications		
ThinkVision LT2024		
ThinkVision LT2024 Platform Specifications		
ThinkVision T1714		
ThinkVision T1714 Platform Specifications		
ThinkVision T1714p		
ThinkVision T1714p Platform Specifications		
ThinkVision T2054p		
ThinkVision T2054p Platform Specifications		
21 Inch - 24 Inch		
ThinkVision LT2423		
ThinkVision LT2423 Platform Specifications		
ThinkVision P24q		
ThinkVision P24q Platform Specifications		
ThinkVision T2224d		
ThinkVision T2224d Platform Specifications		
ThinkVision T2224p		
ThinkVision T2224p Platform Specifications		
ThinkVision T2224z		
ThinkVision T2224z Platform Specifications		
ThinkVision T2254p		
ThinkVision T2254p Platform Specifications		
ThinkVision T2324d		
ThinkVision T2324d Platform Specifications		
ThinkVision T2324p		
ThinkVision T2324p Platform Specifications		
1 ThinkVision T2364t	34	
2 ThinkVision T2364t Platform Specifications	35	
3 ThinkVision T2424p	36	
4 ThinkVision T2424p Platform Specifications	37	
4 ThinkVision T2424z	38	
5 ThinkVision T2424z Platform Specifications	39	
6 ThinkVision T2454p	40	
7 ThinkVision T2454p Platform Specifications	41	
8 ThinkVision X24	42	
9 ThinkVision X24 Platform Specifications	43	
10 ThinkVision X24 Pro	44	
11 ThinkVision X24 Pro Platform Specifications	45	
12 Above 25 Inch	46	
13 ThinkVision P27	46	
14 ThinkVision P27 Platform Specifications	47	
15 ThinkVision P27q	48	
16 ThinkVision P27q Platform Specifications	49	
17 ThinkVision Pro2820	50	
18 ThinkVision Pro2820 Platform Specifications	51	
18 ThinkVision X1	52	
19 ThinkVision X1 Platform Specifications	53	
20 Legal Information	54	
21		
22		
23		
24		
25		
26		
27		
28		
29		
30		
31		
32		
33		

Summary of Changes

This section describes the technical changes made in this edition.

This edition might also include minor corrections and editorial changes which are not identified.

January 25, 2017 - Version 501

Additions in this update

▶ **New product(s)**
ThinkVision P24q
ThinkVision P27q

▶ **New model(s)**
None

▶ **Others**
None

Changes in this update

None

Withdrawals in this update

None



<p>Name E1922s Wide Flat Panel Monitor Case color Black Type-model 60G2AAT6US / 60G2AAR6US / 60G2AAT6EU Panel TFT-LCD, twisted nematic (TN), White LED backlight Viewable image size 18.5" (470mm) diagonal Max view area (W x H) 16.1" x 9.1" / 409.8mm x 230.4mm Native resolution 1366x768 Aspect ratio 16:9 Pixel pitch (mm) 0.3mm Dot/Pixel per Inch 85 dpi Brightness 200 nits or cd/m² (typical) Contrast ratio 600:1 (typical) Pixel response time 5ms (typical) Color gamut 72% Viewing angle at 10:1 CR 180° (+/- 90°) horizontal, 100° (+/- 50°) vertical Stand Tilt adjustable stand Bezel width Sides: 0.73" (18.5mm) Dimensions (HxWxD) 13.44" H x 17.65" W x 6.58" D; 341.5mm H x 448.4mm W x 167.2mm D Power supply 13.7 watts typical, 17 watts maximum, <0.5 watts standby/suspend, universal, integrated (no external brick-like power supply) Weight 6.03 lb; 2.74 kg Limited warranty⁴ 3 year (includes backlight) Available date March 2014</p>	<p style="text-align: center;">Features</p> <ul style="list-style-type: none"> • Widescreen 18.5-inch monitor • Supports HD 1366x768 resolution • Supports VESA mount (100mm) • Mercury free panel and arsenic free glass • Kensington lock slot ready for enhanced security • Support Lenovo Tiny PC via VESA mount • Microsoft® Windows® 7 certified • Microsoft Windows 8 / Windows 8.1 certified 				
<p>VESA-compliant² VESA DPMS-compliant Power management ENERGY STAR® 7.0 Ergonomics ISO 9241-307 Emission standards FCC Class B Environmental TCO (TCO Displays 7.0), WEEE, RoHS, EPEAT™ Gold rating</p>	<div style="text-align: center;">  <p>ThinkVision E1922s Wide Monitor</p> </div>				
<p>Preset resolutions VGA: 640x350, 640x480, 720x400 SVGA: 800x600, 832x624 XGA: 1024x768, 1152x864 SXGA: 1280x1024 WXGA: 1366x768</p> <p>Presets / user settings Standard presets: 15 user settings: 16</p>					
<p>Viewing adjustments Tilt: 20° backward, -5° forward Rotating screen None On screen display On screen display with digital user controls (8 languages) Control features Direct access (control buttons on front) for automatic image setup and adjustment for brightness Multiple input None Monitor connectors VGA 15-pin D-shell, analog, blue Signal cables detachable, VGA 15-pin D-shell at each end, analog, 1.8 meter Mounting features Wall or desk mounting using the Extend Arm or third-party accessories meeting the VESA FPMPI® (100mm mount) Security Security keyhole for attachment of optional cable lock (Kensington® lock-compatible)</p>					
<p>Ship group Monitor with stand, 1.8 meter analog signal cable, 1.8 meter black power cord</p>					
<p style="text-align: center;">Limited Warranty</p> <p>See details at http://support.lenovo.com/en_US/guides-and-manuals/detail.page?DocID=UM008281</p>	<p style="text-align: center;">Accessories</p> <table border="0"> <tr> <td>Kensington MicroSaver Cable Lock</td> <td style="text-align: right;">73P2582</td> </tr> <tr> <td>Kensington Twin Head Cable Lock</td> <td style="text-align: right;">45K1620</td> </tr> </table> <p>See details at www.lenovo.com/support/monitoraccessories</p> <p>See all monitors at www.lenovo.com/thinkvision</p>	Kensington MicroSaver Cable Lock	73P2582	Kensington Twin Head Cable Lock	45K1620
Kensington MicroSaver Cable Lock	73P2582				
Kensington Twin Head Cable Lock	45K1620				



<p>Name E2054 Wide Flat Panel Monitor Case color Raven black Type-model 60DFAAR1US / 60DFAAT1US / 60DFAAT1EU Panel TFT-LCD, In-Plane Switching (IPS), LED backlight Viewable image size 19.5" (494mm) diagonal Max view area (W x H) 16.48" x 10.33" / 418.6mm x 262.4mm Native resolution 1440x900 Aspect ratio 16:10 Pixel pitch (mm) 0.097mm x 0.292mm Dot/Pixel per Inch 87 dpi Brightness 250 nits or cd/m² (typical) Contrast ratio 1000:1 (typical) Pixel response time 7ms (typical) Color gamut 72% Viewing angle at 10:1 CR 178° (+/- 89°) horizontal, 178° (+/- 89°) vertical Stand Tilt adjustable stand Bezel width <i>Top:</i> 0.71" (18.0mm) <i>Bottom:</i> 0.70" (17.9mm) <i>Sides:</i> 1.02" (26.0mm) Dimensions (HxWxD) 14.65" H x 17.95" W x 7.41" D; 372.0mm H x 456.0mm W x 188.3mm D Power supply 16 watts typical, 20 watts maximum, <0.5 watts standby/suspend, universal, integrated (no external brick-like power supply) Weight 6.17 lb; 2.8 kg Limited warranty 3 year (includes backlight) Available date November 2015</p>	<p style="text-align: center;">Features</p> <ul style="list-style-type: none"> • Widescreen 19.5-inch monitor • Supports HD 1440x900 resolution • Supports VESA mount (100mm) • Mercury free panel and arsenic free glass • Kensington lock slot ready for enhanced security • Support Lenovo Tiny PC via VESA mount • Microsoft® Windows® 7 certified • Microsoft Windows 8 / Windows 8.1 certified • Microsoft Windows 10 certified
<p>VESA-compliant VESA DPMS-compliant Power management ENERGY STAR® 6.0 Ergonomics ISO 9241-307 Emission standards FCC Class B Environmental TCO (TCO Displays 6.0), WEEE, RoHS, EPEAT™ Silver rating</p>	<div style="text-align: center;">  <p>ThinkVision E2054 Wide Monitor</p> </div>
<p>Preset resolutions VGA: 640x480, 720x400 SVGA: 800x600 XGA: 1024x768 SXGA: 1280x768, 1280x1024 WXGA: 1366x768 WXGA+: 1440x900 Presets / user settings Standard presets: 18 user settings: 10</p>	
<p>Viewing adjustments <i>Tilt:</i> 22° backward, -5° forward Rotating screen None On screen display On screen display with digital user controls (8 languages) Control features Direct access (control buttons on front) for automatic image setup and adjustment for brightness Multiple input None Monitor connectors VGA 15-pin D-shell, analog, blue Signal cables detachable, VGA 15-pin D-shell at each end, analog, 1.8 meter Mounting features Wall or desk mounting using the Extend Arm or third-party accessories meeting the VESA FPMPI® (100mm mount) Security Security keyhole for attachment of optional cable lock (Kensington® lock-compatible)</p>	
<p>Ship group Monitor with stand, 1.8 meter analog signal cable, 1.8 meter black power cord</p>	

<p style="text-align: center;">Limited Warranty</p> <p>See details at http://support.lenovo.com/en_US/guides-and-manuals/detail.page?DocID=UM008281</p>	<p style="text-align: center;">Accessories</p> <table border="0"> <tr> <td>Kensington MicroSaver Cable Lock</td> <td style="text-align: right;">73P2582</td> </tr> <tr> <td>Kensington Twin Head Cable Lock</td> <td style="text-align: right;">45K1620</td> </tr> </table> <p>See details at www.lenovo.com/support/monitoraccessories</p> <p>See all monitors at www.lenovo.com/thinkvision</p>	Kensington MicroSaver Cable Lock	73P2582	Kensington Twin Head Cable Lock	45K1620
Kensington MicroSaver Cable Lock	73P2582				
Kensington Twin Head Cable Lock	45K1620				



<p>Name LT1913p Square Flat Panel Monitor Case color Black Type-model 60FBHAR1US / 60FBHAT1US / 60FBHAT1EU Panel TFT-LCD, In-Plane Switching (IPS), White LED backlight Viewable image size 19.0" (480.0mm) diagonal Max view area (W x H) 14.76" x 11.80" (374.7mm x 299.8mm) Optimum resolution 1280x1024 Max pixel rate 205MHz (VGA), 165MHz (DVI) Aspect ratio 5:4 Pixel pitch (mm) 0.0976 (H) x 0.2928 (V) mm Dot/Pixel per Inch 86.8 dpi Brightness 250 nits or cd/m² (typical) Contrast ratio 1000:1 (typical) Pixel response time 7ms (typical) Color gamut 72% Viewing angle at 10:1 CR 178° horizontal, 178° vertical Stand Tilt, swivel, pivot, and height adjustable stand Bezel width Sides: 0.68" (17.4mm); top: 0.68" (17.4mm); bottom: 0.68" (17.4mm) Dimensions (HxWxD) 14.63" H x 16.18" W x 10.40" D; 371.5mm H x 411.0mm W x 264.2mm D Power supply 24 watts typical, 27 watts maximum, <0.5 watts standby/suspend, universal, integrated (no external brick-like power supply) Weight 10.69 lb; 4.85kg Limited warranty⁴ 3 year (includes backlight) Available date April 2015</p>	<p>Features</p> <ul style="list-style-type: none"> • 19-inch Square IPS LED backlit panel • Supports 1280x1024 resolution • Supports ThinkCentre Tiny Clamp Bracket • Mercury and arsenic free glass • Low Halogen • Recycled content in plastic material • Microsoft® Windows® 7 certified • Microsoft Windows 8 / Windows 8.1 certified • Microsoft Windows 10 certified 								
<p>VESA-compliant² VESA DDC2B/C1, EDID 1.3 Power management ENERGY STAR® 7.0 Ergonomics ISO 9241-307 Emission standards FCC Class B Environmental TCO Displays 7.0, TCO Certified Edge 1.1, WEEE, RoHS, EPEAT™ Gold rating, ULE Gold</p> <p>Preset resolutions VGA: 640x350, 640x480, 720x400 SVGA: 800x600, 823x624 XGA: 1024x768, 1152x864, 1152x900 SXGA: 1280x1024</p> <p>Presets / user settings Standard presets: 20; user settings: 20</p>	 <p>ThinkVision LT1913p Square Monitor</p>								
<p>Viewing adjustments Tilt: 30° back, -5° forward; lift: 4.3" (110mm); swivel: +/- 45° Rotating screen Screen pivots 90 degrees from landscape to portrait On screen display On screen display with digital user controls (8 languages) Control features Direct access (buttons on front) for automatic image setup, input switch, and brightness Multiple input Dual input (two different PCs attach to two different connectors; one PC shows image; select via button) Monitor connectors (1) VGA 15-pin D-shell, analog, blue (2) Digital Visual Interface (DVI-D), digital, white, HDCP-compliant Signal cables (1) detachable, VGA 15-pin D-shell at each end, analog, 1.8 meter (2) detachable, DVI-D at each end, digital, 1.8 meter Mounting features Wall or desk mounting using the Extend Arm or third-party accessories meeting the VESA FPMPI® (100mm mount) Security Security keyhole for attachment of optional cable lock (Kensington® lock-compatible)</p> <p>Ship group Monitor, attached stand, Setup poster, Safety and Warranty Information, 1.8 meter analog signal cable, 1.8 meter DVI-D cable, 1.8 meter black power cord</p>									
<p>Limited Warranty</p> <p>See details at http://support.lenovo.com/en_US/guides-and-manuals/detail.page?DocID=UM008281</p>	<p>Accessories</p> <table border="0"> <tr> <td>Kensington MicroSaver Cable Lock</td> <td>73P2582</td> </tr> <tr> <td>Kensington Twin Head Cable Lock</td> <td>45K1620</td> </tr> <tr> <td>Lenovo Security Cable Lock</td> <td>57Y4303</td> </tr> <tr> <td>Lenovo Easy Reach Monitor Stand</td> <td>55Y9258</td> </tr> </table> <p>See details at www.lenovo.com/support/monitoraccessories</p> <p>See all monitors at www.lenovo.com/thinkvision</p>	Kensington MicroSaver Cable Lock	73P2582	Kensington Twin Head Cable Lock	45K1620	Lenovo Security Cable Lock	57Y4303	Lenovo Easy Reach Monitor Stand	55Y9258
Kensington MicroSaver Cable Lock	73P2582								
Kensington Twin Head Cable Lock	45K1620								
Lenovo Security Cable Lock	57Y4303								
Lenovo Easy Reach Monitor Stand	55Y9258								



<p>Name LT2024 Wide Flat Panel Monitor Case color Business black Type-model 60B9HAR1US Panel TFT-LCD, twisted nematic (TN), White LED backlight Viewable image size 20.0" (508mm) diagonal Max view area (W x H) 17.4" x 9.8" (442.8mm x 249.1mm) Native resolution 1600x900 Aspect ratio 16:9 Pixel pitch (mm) .276mm Dot/Pixel per Inch 92 dpi Brightness 250 nits or cd/m² (typical) Contrast ratio 1000:1 (typical) Pixel response time 5ms (typical) Color gamut 72% Viewing angle at 10:1 CR 170° (+/- 85°) horizontal, 160° (+/- 80°) vertical Stand Tilt adjustable stand Bezel width Sides: 0.567" (14.4mm) Dimensions (HxWxD) 13.68" H x 18.83" W x 6.33" D; 347.4mm H x 478.4mm W x 160.7mm D Power supply 19 watts typical, 22 watts maximum, <0.5 watts standby/suspend, universal, integrated (no external brick-like power supply) Weight 6.75 lb; 3.07 kg Limited warranty⁴ 3 year (includes backlight) Available date March 2014</p>	<p style="text-align: center;">Features</p> <ul style="list-style-type: none"> • Widescreen 20-inch monitor • Supports 1600x900 resolution • Includes dual input connection for attachment to two systems concurrently (analog and digital) • Arsenic / Mercury free glass • EPEAT Gold certified • Support Lenovo Tiny PC and 3rd party thin client • Microsoft® Windows® 7 certified • Microsoft Windows 8 / Windows 8.1 certified 				
<p>VESA-compliant² VESA DDC2B/CI Power management ENERGY STAR® qualified Ergonomics ISO 9241-307 Emission standards FCC Class B Environmental TCO Displays 6.0, TCO Certified Edge 1.2, WEEE, RoHS, EPEAT™ Gold rating</p>	<div style="text-align: center;">  <p>ThinkVision LT2024 Wide Monitor</p> </div>				
<p>Preset resolutions VGA: 640x350, 640x480, 720x400 SVGA: 800x600, 832x624 XGA: 1024x768, 1152x864 SXGA: 1280x1024 WXGA: 1366x768 WXGA+: 1440x900, 1600x900</p> <p>Presets / user settings Standard presets: 24 user settings: 24</p>					
<p>Viewing adjustments Tilt: 22° backward, -5° forward Rotating screen None On screen display On screen display with digital user controls (8 languages) Control features Direct access (buttons on front) for automatic image setup, dual input and brightness Multiple input Dual input (two different PCs attach to two different connectors; one PC shows image; select via button) Monitor connectors (1) VGA 15-pin D-shell, analog, blue (2) Digital Visual Interface (DVI-D), digital, white, HDCP-compliant Signal cables (1) detachable, VGA 15-pin D-shell at each end, analog, 1.8 meter Mounting features Wall or desk mounting using the Extend Arm or third-party accessories meeting the VESA FPMPI® (100mm mount) Security Security keyhole for attachment of optional cable lock (Kensington® lock-compatible)</p>					
<p>Ship group Monitor with stand, Safety and Warranty Information, 1.8 meter analog signal cable, 1.8 meter black power cord</p>	<p style="text-align: center;">Accessories</p> <table border="0" style="width: 100%;"> <tr> <td>Kensington MicroSaver Cable Lock</td> <td style="text-align: right;">73P2582</td> </tr> <tr> <td>Kensington Twin Head Cable Lock</td> <td style="text-align: right;">45K1620</td> </tr> </table> <p>See details at www.lenovo.com/support/monitoraccessories</p> <p>See all monitors at www.lenovo.com/thinkvision</p>	Kensington MicroSaver Cable Lock	73P2582	Kensington Twin Head Cable Lock	45K1620
Kensington MicroSaver Cable Lock	73P2582				
Kensington Twin Head Cable Lock	45K1620				
<p style="text-align: center;">Limited Warranty</p> <p>See details at http://support.lenovo.com/en_US/guides-and-manuals/detail.page?DocID=UM008281</p>					

See footnotes for important warranty information
 US model announced February 18, 2014



<p>Name T1714 Square Flat Panel Monitor Case color Black Type-model 60FDHAT1EU / 60FDHAR1US / 60FDHAT1EU Panel TFT-LCD, twisted nematic (TN), White LED backlight Viewable image size 17.0" (432mm) diagonal Max view area (W x H) 13.3" x 10.6" (337.9mm x 270.3mm) Optimum resolution 1280x1024 Aspect ratio 5:4 Pixel pitch (mm) 0.264mm Dot/Pixel per Inch 96 dpi Brightness 250 nits or cd/m² (typical) Contrast ratio 1000:1 (typical) Pixel response time 5ms (typical) Color gamut 72% Viewing angle at 10:1 CR 170° (+/- 85°) horizontal, 160° (+/- 80°) vertical Stand Tilt stand Bezel width Sides: 0.69" (17.5mm) Dimensions (HxWxD, including stand) 14.72" H x 14.74" W x 7.87" D; 373.9mm H x 374.5mm W x 200mm D Power supply 14.0 watts typical, 18.0 watts maximum, <0.5 watts standby/suspend, universal, integrated (no external brick-like power supply) Weight 5.75 lb; 2.61kg Limited warranty 3 year (includes backlight) Available date September 2015</p>	<p>Features</p> <ul style="list-style-type: none"> • 17-inch Square LCD monitor • Supports SXGA 1280x1024 resolution • Includes dual input connection for attachment to two systems concurrently (analog and digital) • Mercury Arsenic free glass • Microsoft® Windows® 7 certified • Microsoft Windows 8 certified • Microsoft Windows 8.1 certified • Microsoft Windows 10 certified 						
<p>VESA-compliant VESA DDC2B/CI Power management ENERGY STAR® 7.0 Ergonomics ISO 9241-307 Emission standards FCC Class B Environmental TCO Displays 7.0, TCO Certified Edge 2.0, WEEE, RoHS, EPEAT™ Gold rating</p>	<div style="text-align: center;">  <p>ThinkVision T1714 Monitor</p> </div>						
<p>Preset resolutions VGA: 640x350, 640x480, 720x400 SVGA: 800x600 XGA: 1024x768, 1152x864, SXGA: 1280x800, 1280x1024</p> <p>Presets / user settings Standard presets: 17; user settings: 17</p>							
<p>Viewing adjustments Tilt: 22° back, -5° forward Rotating screen None On screen display On screen display with digital user controls (8 languages) Control features Direct access (buttons on front) for automatic image setup and brightness Multiple input Dual input (two different PCs attach to two different connectors; one PC shows image; select via button) Monitor connectors (1) VGA 15-pin D-shell, analog, blue (2) Digital Visual Interface (DVI-D), digital, white, HDCP-compliant Signal cables (1) detachable, VGA 15-pin D-shell at each end, analog, 1.8 meter (2) detachable, DVI-D at each end, digital, 1.8 meter Mounting features Wall or desk mounting using the Extend Arm or third-party accessories meeting the VESA FPMPI® (100mm mount) Security Security keyhole for attachment of optional cable lock (Kensington® lock-compatible)</p>							
<p>Ship group Monitor and stand, Setup poster, Safety and Warranty Information, 1.8 meter analog signal cable, 1.8 meter DVI-D cable, 1.8 meter black power cord</p>	<p>Limited Warranty</p> <p>See details at http://support.lenovo.com/en_US/guides-and-manuals/detail.page?DocID=UM008281</p> <p>Accessories</p> <table border="0"> <tr> <td>Kensington MicroSaver Cable Lock</td> <td>73P2582</td> </tr> <tr> <td>Kensington Twin Head Cable Lock</td> <td>45K1620</td> </tr> <tr> <td>Lenovo Easy Reach Monitor Stand</td> <td>55Y9258</td> </tr> </table> <p>See details at www.lenovo.com/support/monitoraccessories</p> <p>See all monitors at www.lenovo.com/thinkvision</p>	Kensington MicroSaver Cable Lock	73P2582	Kensington Twin Head Cable Lock	45K1620	Lenovo Easy Reach Monitor Stand	55Y9258
Kensington MicroSaver Cable Lock	73P2582						
Kensington Twin Head Cable Lock	45K1620						
Lenovo Easy Reach Monitor Stand	55Y9258						



<p>Name T1714p Square Flat Panel Monitor Case color Black Type-model 60FELAT1US / 60FELAR1US / 60FELAT1EU Panel TFT-LCD, twisted nematic (TN), White LED backlight Viewable image size 17.0" (432mm) diagonal Max view area (W x H) 13.3" x 10.6" (337.9mm x 270.3mm) Optimum resolution 1280x1024 Aspect ratio 5:4 Pixel pitch (mm) 0.264mm Dot/Pixel per Inch 96 dpi Brightness 250 nits or cd/m² (typical) Contrast ratio 1000:1 (typical) Pixel response time 5ms (typical) Color gamut 72% Viewing angle at 10:1 CR 170° (+/- 85°) horizontal, 160° (+/- 80°) vertical Stand Tilt height adjustable stand Bezel width Sides: 0.69" (17.5mm) Dimensions 17.63" H x 14.74" W x 9.61" D; (HxWxD, including stand) 447.9mm H x 374.5mm W x 244.2mm D Power supply 14.0 watts typical, 18.0 watts maximum, <0.5 watts standby/suspend, universal, integrated (no external brick-like power supply) Weight 8.71 lb; 3.95kg Limited warranty 3 year (includes backlight) Available date September 2015</p>	<p>Features</p> <ul style="list-style-type: none"> • 17-inch Square LCD monitor • Supports SXGA 1280x1024 resolution • Includes dual input connection for attachment to two systems concurrently (analog and digital) • Mercury Arsenic free glass • Supports Lenovo Tiny PC and 3rd party thin client via optional Lenovo bracket • Microsoft® Windows® 7 certified • Microsoft Windows 8 certified • Microsoft Windows 8.1 certified • Microsoft Windows 10 certified 						
<p>VESA-compliant VESA DDC2B/CI Power management ENERGY STAR® 7.0 Ergonomics ISO 9241-307 Emission standards FCC Class B Environmental TCO Displays 7.0, TCO Certified Edge 2.0, WEEE, RoHS, EPEAT™ Gold rating</p>	<div style="text-align: center;">  <p>ThinkVision T1714p Monitor</p> </div>						
<p>Preset resolutions VGA: 640x350, 640x480, 720x400 SVGA: 800x600 XGA: 1024x768, 1152x864, SXGA: 1280x800, 1280x1024 Presets / user settings Standard presets: 22; user settings: 22</p>							
<p>Viewing adjustments Tilt: 22° back, -5° forward; lift: 4.3" (110mm) Rotating screen None On screen display On screen display with digital user controls (8 languages) Control features Direct access (buttons on front) for automatic image setup and brightness Multiple input Dual input (two different PCs attach to two different connectors; one PC shows image; select via button) Monitor connectors (1) VGA 15-pin D-shell, analog, blue (2) Digital Visual Interface (DVI-D), digital, white, HDCP-compliant (3) DisplayPort, digital, black, HDCP-compliant Signal cables (1) detachable, VGA 15-pin D-shell at each end, analog, 1.8 meter (2) detachable, DVI-D at each end, digital, 1.8 meter Mounting features Wall or desk mounting using the Extend Arm or third-party accessories meeting the VESA FPMPI® (100mm mount) Security Security keyhole for attachment of optional cable lock (Kensington® lock-compatible)</p>	<p>Ship group Monitor and stand, Setup poster, Safety and Warranty Information, 1.8 meter analog signal cable, 1.8 meter DVI-D cable, 1.8 meter black power cord</p>						
<p style="text-align: center;">Limited Warranty</p> <p>See details at http://support.lenovo.com/en_US/guides-and-manuals/detail.page?DocID=UM008281</p>	<p style="text-align: center;">Accessories</p> <table border="0"> <tr> <td>Kensington MicroSaver Cable Lock</td> <td style="text-align: right;">73P2582</td> </tr> <tr> <td>Kensington Twin Head Cable Lock</td> <td style="text-align: right;">45K1620</td> </tr> <tr> <td>Lenovo Easy Reach Monitor Stand</td> <td style="text-align: right;">55Y9258</td> </tr> </table> <p>See details at www.lenovo.com/support/monitoraccessories</p> <p>See all monitors at www.lenovo.com/thinkvision</p>	Kensington MicroSaver Cable Lock	73P2582	Kensington Twin Head Cable Lock	45K1620	Lenovo Easy Reach Monitor Stand	55Y9258
Kensington MicroSaver Cable Lock	73P2582						
Kensington Twin Head Cable Lock	45K1620						
Lenovo Easy Reach Monitor Stand	55Y9258						



<p>Name T2054p Wide Flat Panel Monitor Bezel color Raven black Type-model 60G1MAR2US / 60G1MAT2US / 60G1MAT2EU Panel TFT-LCD, In-Plane Switching (IPS), White LED backlight Viewable image size 19.5" (495mm) diagonal Max view area (W x H) 16.48" x 10.33" (418.6mm x 262.4mm) Native resolution 1440x900 Aspect ratio 16:10 Pixel pitch (mm) 0.2915 x 0.2915 mm Dot/Pixel per Inch 87 dpi Brightness 250 nits or cd/m² (typical) Contrast ratio 1000:1 (typical) Pixel response time 7ms (typical) Color gamut 72% Viewing angle at 10:1 CR 178° (+/- 89°) horizontal, 178° (+/- 89°) vertical Stand Tilt, swivel, and height adjustable Bezel width Sides: 0.67" (17.0mm) Dimensions (HxWxD) 13.62" H x 17.88" W x 9.55" D; 345.9mm H x 454.2mm W x 242.6mm D Power supply 14.5 watts typical, 21 watts maximum, <0.3 watts standby/suspend, universal, integrated (no external brick-like power supply) Weight 8.16 lb; 3.70 kg Limited warranty⁴ 3 year (includes backlight) Available date September 2015</p>	<p style="text-align: center;">Features</p> <ul style="list-style-type: none"> • Widescreen 19.5-inch monitor • Supports 1440x900 resolution • Supports ThinkCentre Tiny Clamp Bracket • Includes dual input connection for attachment to two systems concurrently (analog and digital) • EPEAT Gold certified • Microsoft® Windows® 7 certified • Microsoft Windows 8 / Windows 8.1 certified • Microsoft Windows 10 certified 				
<p>VESA-compliant² VESA DDC2B/CI Power management ENERGY STAR® qualified Ergonomics ISO 9241-307 Emission standards FCC Class B Environmental TCO Displays 7.0, TCO Certified Edge 2.0, WEEE, RoHS, EPEAT™ Gold rating</p>	<div style="text-align: center;">  <p>ThinkVision T2054p Wide Monitor</p> </div>				
<p>Preset resolutions VGA: 640x480, 720x400, 720x576 SVGA: 800x600 XGA: 1024x768, 1152x864 SXGA: 1280x800, 1280x1024 WXGA: 1366x768 WXGA+: 1440x900 Presets / user settings Standard presets: 22 user settings: 16</p>					
<p>Viewing adjustments Tilt: 22° backward, -5° forward; lift: 4.3" (110mm); swivel: +/-45°; detachable stand Rotating screen None On screen display On screen display with digital user controls (8 languages) Control features Direct access (buttons on front) for automatic image setup, dual input and brightness Multiple input Dual input (two different PCs attach to two different connectors; one PC shows image; select via button) Monitor connectors (1) VGA 15-pin D-shell, analog, blue (2) HDMI (1.4), digital, HDCP-compliant (3) DisplayPort, digital, black, HDCP-compliant Signal cables (1) detachable, VGA 15-pin D-shell at each end, analog, 1.8 meter (2) detachable, DisplayPort at each end, digital, 1.8 meter Mounting features Wall or desk mounting using the Extend Arm or third-party accessories, 100mm x 100mm mount Security Security keyhole for attachment of optional cable lock (Kensington® lock-compatible) Ship group Monitor with stand, Safety and Warranty Information, 1.8 meter analog signal cable, 1.8 meter DP signal cable, 1.8 meter black power cord</p>					
<p style="text-align: center;">Limited Warranty</p> <p>See details at http://support.lenovo.com/en_US/guides-and-manuals/detail.page?DocID=UM008281</p>	<p style="text-align: center;">Accessories</p> <table border="0"> <tr> <td>Kensington MicroSaver Cable Lock</td> <td style="text-align: right;">73P2582</td> </tr> <tr> <td>Kensington Twin Head Cable Lock</td> <td style="text-align: right;">45K1620</td> </tr> </table> <p>See details at www.lenovo.com/support/monitoraccessories</p> <p>See all monitors at www.lenovo.com/thinkvision</p>	Kensington MicroSaver Cable Lock	73P2582	Kensington Twin Head Cable Lock	45K1620
Kensington MicroSaver Cable Lock	73P2582				
Kensington Twin Head Cable Lock	45K1620				



<p>Name LT2423 Wide Flat Panel Monitor Case color Business black Type-model 60A8KAR2US / 60A8KAT2US / 60A8KAT2EU Panel TFT-LCD, twisted nematic (TN), White LED backlight Viewable image size 24" (610mm) diagonal Max view area (W x H) 20.9" x 11.8" (531.4mm x 298.9mm) Optimum resolution 1920x1080 Max pixel rate 205MHz Aspect ratio 16:9 Pixel pitch (mm) 0.278mm Dot/Pixel per Inch 92 dpi Brightness 250 nits or cd/m² (typical) Contrast ratio 1000:1 (typical) Contrast ratio 2000000:1 Pixel response time 5ms Color gamut 72% Viewing angle at 10:1 CR 170° horizontal, 160° vertical Stand Tilt stand Bezel width Sides: 0.67" (17.0mm); top: 0.67" (17.0mm); bottom: 1.02" (26.0mm)</p> <p>Dimensions (HxWxD, excluding stand) 13.53" H x 22.33" W x 1.97" D; (HxWxD, including stand) 343.7mm H x 567.1mm W x 50.0mm D Dimensions (HxWxD, including stand) 16.30" H x 22.33" W x 8.50" D; (HxWxD, including stand) 414.3mm H x 567.1mm W x 216.7mm D Power supply 21 watts typical, 31 watts maximum, <0.5 watts standby/suspend, universal, integrated (no external brick-like power supply)</p> <p>Weight 8.30 lb; 3.76kg Limited warranty⁴ 3 year (includes backlight) Available date July 2013</p>	<p>Features</p> <ul style="list-style-type: none"> • Widescreen 24-inch monitor • Supports 1920x1080 resolution • Two 3W stereo speakers • Audio in (3.5mm) • Supports VGA and HDMI 1.4 interfaces • Support Lenovo Tiny PC and 3rd party thin client via optional Lenovo bracket • Microsoft® Windows® 8 certified • Arsenic/Lead/Mercury free 										
<p>VESA-compliant² VESA DDC2B/CI Power management ENERGY STAR® 6.0 Ergonomics ISO 9241-307 Emission standards MPR-2, FCC Class B Environmental TCO Displays 6.0, TCO Certified Edge 1.2, WEEE, RoHS, EPEAT™ Gold rating, ULE Gold</p> <p>Preset resolutions VGA: 640x350, 640x480, 720x400 SVGA: 800x600, 832x624 XGA: 1024x768, 1152x864 SXGA: 1280x1024 WXGA: 1366x768 WXGA+: 1440x900, 1600x900 WSXGA+: 1680x1050 Full HD: 1920x1080</p> <p>Presets / user settings Standard presets: 24; User settings: 20</p>	 <p>ThinkVision LT2423 Wide Monitor</p>										
<p>Viewing adjustments Tilt: 22° back, -5° forward Rotating screen None On screen display On screen display with digital user controls (8 languages) Control features Direct access (buttons on front) for automatic image setup, input switch, and brightness Multimedia Integrated stereo speakers (3 watts x 2) Multiple input Dual input (two different PCs attach to two different connectors; one PC shows image; select via button) Monitor connectors (1) VGA 15-pin D-shell, analog, blue (2) HDMI (1.4), digital, HDCP-compliant Signal cables (1) detachable, VGA 15-pin D-shell at each end, analog, 1.8 meter Mounting features Wall or desk mounting using the Extend Arm or third-party accessories meeting the VESA FPMPI® (100mm mount) Security Security keyhole for attachment of optional cable lock (Kensington® lock-compatible)</p>											
<p>Ship group Monitor, attached stand, Setup poster, Safety and Warranty Information, 1.8 meter analog signal cable, 1.8 meter Audio cable, 1.8 meter black power cord</p>											
<p>Limited Warranty</p> <p>See details at http://support.lenovo.com/en_US/guides-and-manuals/detail.page?DocID=UM008281</p>	<p>Accessories</p> <table border="0"> <tr> <td>Kensington MicroSaver Cable Lock</td> <td>73P2582</td> </tr> <tr> <td>Kensington Twin Head Cable Lock</td> <td>45K1620</td> </tr> <tr> <td>Lenovo Security Cable Lock</td> <td>57Y4303</td> </tr> <tr> <td>ThinkCentre Extend Arm</td> <td>57Y4352</td> </tr> <tr> <td>Lenovo Easy Reach Monitor Stand</td> <td>55Y9258</td> </tr> </table> <p>See details at www.lenovo.com/support/monitoraccessories</p> <p>See all monitors at www.lenovo.com/thinkvision</p>	Kensington MicroSaver Cable Lock	73P2582	Kensington Twin Head Cable Lock	45K1620	Lenovo Security Cable Lock	57Y4303	ThinkCentre Extend Arm	57Y4352	Lenovo Easy Reach Monitor Stand	55Y9258
Kensington MicroSaver Cable Lock	73P2582										
Kensington Twin Head Cable Lock	45K1620										
Lenovo Security Cable Lock	57Y4303										
ThinkCentre Extend Arm	57Y4352										
Lenovo Easy Reach Monitor Stand	55Y9258										

See footnotes for important warranty information
 US model announced June 25, 2013



<p>Name P24q Wide Flat Panel Monitor Case color Black Type-model 61A5GAR3US / 61A5GAT3EU Panel TFT-LCD, IPS (In-Plane Switching), White LED backlight Viewable image size 23.8" (604.5mm) diagonal Max view area (W x H) 20.74" x 11.67" (526.85mm x 296.35mm) Optimum resolution 2560x1440 Max pixel rate 300MHz Aspect ratio 16:9 Pixel pitch (mm) 0.2058 x 0.2058mm Dot/Pixel per Inch 123 dpi Brightness 300 nits or cd/m² (typical) Contrast ratio 1000:1 (typical) Pixel response time 4ms Color gamut 99% sRGB Viewing angle at 10:1 CR 178° horizontal, 178° vertical Stand Tilt, swivel, pivot, and height adjustable stand Bezel width <i>Sides:</i> 0.08" (2mm) Dimensions 14.7" H x 21.26" W x 10.3" D; (HxWxD, including stand) 373.4mm H x 540.2mm W x 261.75mm D Power supply 24 watts typical, 67 watts maximum (with USB), <0.5 watts sleep/off; <0.5 watts switch off integrated (no external brick-like power supply) Weight 12.35 lb; 5.6kg (including stand) Limited warranty 3 year Available date January 2017</p>	<p>Features</p> <ul style="list-style-type: none"> • 23.8-inch IPS LED backlight monitor • Supports 2560x1440 resolution • 5-Ports USB hub, support USB 3.0 • Support ThinkCentre Tiny • Microsoft® Windows® 7 certified • Microsoft Windows 10 certified 						
<p>VESA-compliant VESA DDC2B/CI Power management ENERGY STAR® 7.0 Ergonomics ISO 9241-307 Emission standards FCC Class B Environmental TCO Displays 7.0, RoHS, EPEAT™ Gold rating, ULE Gold</p>	 <p>ThinkVision P24q Monitor</p>						
<p>Preset resolutions VGA: 640x480, 720x400 SVGA: 800x600 XGA: 1024x768 SXGA: 1280x1024 WXGA: 1366x768 WXGA+: 1440x900, 1600x900 WSXGA+: 1680x1050 Full HD: 1920x1080, 1920x1200 QHD: 2560x1440</p> <p>Presets / user settings Standard presets: 20; user settings: 24</p>							
<p>Viewing adjustments <i>Tilt:</i> 30° back, -5° forward; <i>lift:</i> 4.33" (110mm); <i>swivel:</i> +/-45° Rotating screen Screen pivots 90 degrees from landscape to portrait On screen display On screen display with digital user controls (8 languages) Control features Direct access for menu, source switch, and brightness USB hub USB Hub: one USB 3.0 upstream port, four USB 3.0 downstream ports Multimedia Audio-out, optional sound bar supported Camera None Multiple input Support HDMI, DisplayPort, mini DisplayPort, DisplayPort-out Monitor connectors (1) 2*HDMI (1.4), digital, HDCP-compliant (2) DisplayPort (1.2), digital, HDCP-compliant (3) Mini DisplayPort, digital, HDCP-compliant Signal cables (1) detachable, mini DisplayPort to DisplayPort, digital, 1.8 meter Mounting features Wall or desk mounting using the Extend Arm or third-party accessories meeting the VESA FPMPI® (100mm mount) Security Security keyhole for attachment of optional cable lock (Kensington® lock-compatible)</p>							
<p>Ship group Monitor, detachable stand, Quick start and safety poster, 1.8 meter USB 3.0 cable, 1.8 meter mini DP to DP cable, 1.8 meter black power cord</p>	<p>Limited Warranty</p> <p>See details at http://support.lenovo.com/en_US/guides-and-manuals/detail.page?DocID=UM008281</p> <p>Accessories</p> <table border="0"> <tr> <td>Kensington MicroSaver Cable Lock</td> <td>73P2582</td> </tr> <tr> <td>Kensington Twin Head Cable Lock</td> <td>45K1620</td> </tr> <tr> <td>Lenovo Security Cable Lock</td> <td>57Y4303</td> </tr> </table> <p>See details at www.lenovo.com/support/monitoraccessories</p> <p>See all monitors at www.lenovo.com/thinkvision</p>	Kensington MicroSaver Cable Lock	73P2582	Kensington Twin Head Cable Lock	45K1620	Lenovo Security Cable Lock	57Y4303
Kensington MicroSaver Cable Lock	73P2582						
Kensington Twin Head Cable Lock	45K1620						
Lenovo Security Cable Lock	57Y4303						



<p>Name T2224d Wide Flat Panel Monitor Bezel color Black Type-model 60EBJAR1US / 60EBJAT1US / 60EBJAT1EU Panel TFT-LCD, Vertical Alignment panel (VA), White LED backlight</p> <p>Viewable image size 21.5" (546mm) diagonal Max view area (W x H) 18.74" x 10.54" (476.1mm x 267.8mm) Native resolution 1920x1080 Aspect ratio 16:9 Pixel pitch (mm) 0.248 x 0.248 mm Dot/Pixel per Inch 102 dpi Brightness 250 nits or cd/m² (typical) Contrast ratio 3000:1 (typical) Pixel response time 7ms (typical); 4ms (extreme mode) Color gamut 72% Viewing angle at 10:1 CR 178° (+/- 89°) horizontal, 178° (+/- 89°) vertical Stand Tilt stand Bezel width <i>Sides:</i> 0.69" (17.6mm) Dimensions (HxWxD) 15.02" H x 20.19" W x 8.06" D; 381.4mm H x 512.9mm W x 204.9mm D</p> <p>Power supply 20 watts typical, 25 watts maximum <0.5 watts standby/suspend, universal, integrated (no external brick-like power supply)</p> <p>Weight 6.48 lb; 2.94 kg Limited warranty 3 year (includes backlight) Available date July 2016</p>	<p style="text-align: center;">Features</p> <ul style="list-style-type: none"> • Widescreen 21.5-inch monitor • Supports 1920x1080 resolution • Supports optional soundbar • Supports ThinkCentre Tiny via VESA back mount • Includes dual input connection for attachment to two systems concurrently (analog and digital) • EPEAT Gold certified • Microsoft® Windows® 7 certified • Microsoft Windows 10 certified 				
<p>VESA-compliant VESA DDC2B/CI Power management ENERGY STAR® qualified Ergonomics ISO 9241-307 Emission standards FCC Class B Environmental TCO Displays 7.0, TCO Certified Edge 2.0, WEEE, RoHS, EPEAT™ Gold rating</p>	<div style="text-align: center;">  <p>ThinkVision T2224d Wide Monitor</p> </div>				
<p>Preset resolutions VGA: 640x350, 640x480, 720x400 SVGA: 800x600, 832x624 XGA: 1024x768, 1152x864 SXGA: 1280x1024 WXGA: 1280x768, 1280x800 WXGA+: 1440x900 WSXGA+: 1680x1050 Full HD: 1920x1080</p> <p>Presets / user settings Standard presets: 22; user settings: 22</p>					
<p>Viewing adjustments <i>Tilt:</i> 22° back, -5° forward Rotating screen None On screen display On screen display with digital user controls (8 languages) Control features Direct access (buttons on front) for automatic image setup, dual input and brightness USB hub None Multiple input Dual input (two different PCs attach to two different connectors; one PC shows image; select via button) Monitor connectors (1) VGA 15-pin D-shell, analog, blue (2) DisplayPort, digital, black, HDCP-compliant</p> <p>Signal cables (1) detachable, VGA 15-pin D-shell at each end, analog, 1.8 meter (2) detachable, DisplayPort at each end, digital, 1.8 meter</p> <p>Mounting features Wall or desk mounting using the Extend Arm or third-party accessories, 100mm x 100mm mount Security Security keyhole for attachment of optional cable lock (Kensington® lock-compatible)</p>					
<p>Ship group Monitor with stand, Safety and Warranty Information, 1.8 meter analog signal cable, 1.8 meter DP signal cable, 1.8 meter black power cord</p>					
<p style="text-align: center;">Limited Warranty</p> <p>See details at http://support.lenovo.com/en_US/guides-and-manuals/detail.page?DocID=UM008281</p>	<p style="text-align: center;">Accessories</p> <table border="0" style="width: 100%;"> <tr> <td>Kensington MicroSaver Cable Lock</td> <td style="text-align: right;">73P2582</td> </tr> <tr> <td>Kensington Twin Head Cable Lock</td> <td style="text-align: right;">45K1620</td> </tr> </table> <p>See details at www.lenovo.com/support/monitoraccessories</p> <p>See all monitors at www.lenovo.com/thinkvision</p>	Kensington MicroSaver Cable Lock	73P2582	Kensington Twin Head Cable Lock	45K1620
Kensington MicroSaver Cable Lock	73P2582				
Kensington Twin Head Cable Lock	45K1620				



<p>Name T2224p Wide Flat Panel Monitor Bezel color Raven black Type-model 60F4MAR6US / 60F4MAT6US / 60CAMAT6EU Panel TFT-LCD, In-Plane Switching (IPS), White LED backlight</p> <p>Viewable image size 21.5" (546mm) diagonal Max view area (W x H) 18.74" x 10.54" (476.1mm x 267.8mm) Native resolution 1920x1080 Aspect ratio 16:9 Pixel pitch (mm) 0.248 x 0.248 mm Dot/Pixel per Inch 102 dpi Brightness 250 nits or cd/m² (typical) Contrast ratio 1000:1 (typical) Pixel response time 7ms (typical) Color gamut 72% Viewing angle at 10:1 CR 178° (+/- 89°) horizontal, 178° (+/- 89°) vertical Stand Tilt, swivel, pivot, and height adjustable stand Bezel width Sides: 0.69" (17.6mm) Dimensions (HxWxD) 13.56" H x 20.19" W x 9.55" D; 344.3mm H x 512.9mm W x 242.7mm D</p> <p>Power supply 21 watts typical, 25 watts maximum (without USB 3.0 hub), 48 watts maximum (with USB 3.0 hub), <0.5 watts standby/suspend, universal, integrated (no external brick-like power supply) Weight 10.65 lb; 4.84 kg Limited warranty 3 year (includes backlight) Available date March 2015</p>	<p style="text-align: center;">Features</p> <ul style="list-style-type: none"> • Widescreen 21.5-inch monitor • Supports 1920x1080 resolution • Supports ThinkCentre Tiny Clamp Bracket • Supports optional soundbar • Includes dual input connection for attachment to two systems concurrently (analog and digital) • EPEAT Gold certified • Microsoft® Windows® 7 certified • Microsoft Windows 8 / Windows 8.1 certified • Microsoft Windows 10 certified 				
<p>VESA-compliant VESA DDC2B/CI Power management ENERGY STAR® qualified Ergonomics ISO 9241-307 Emission standards FCC Class B Environmental TCO Displays 7.0, TCO Certified Edge 2.0, WEEE, RoHS, EPEAT™ Gold rating</p>	<div style="text-align: center;">  <p>ThinkVision T2224p Wide Monitor</p> </div>				
<p>Preset resolutions VGA: 640x350, 640x480, 720x400 SVGA: 800x600 XGA: 1024x768, 1152x864 SXGA: 1280x1024 WXGA: 1280x768, 1280x800, 1366x768 WXGA+: 1440x900 WSXGA+: 1680x1050 Full HD: 1920x1080</p> <p>Presets / user settings Standard presets: 27; user settings: 20</p>					
<p>Viewing adjustments <i>Tilt:</i> 30° back, -5° forward; <i>lift:</i> 4.3" (110mm); <i>swivel:</i> +/-45°; detachable stand Rotating screen Screen pivots 90 degrees from landscape to portrait On screen display On screen display with digital user controls (8 languages) Control features Direct access (buttons on front) for automatic image setup, dual input and brightness USB hub USB 3.0 Hub: 1 port into PC (USB 3.0); 4 ports for accessories (4 USB 3.0) Multiple input Dual input (two different PCs attach to two different connectors; one PC shows image; select via button) Monitor connectors (1) VGA 15-pin D-shell, analog, blue (2) HDMI (1.4), digital, HDCP-compliant (3) DisplayPort, digital, black, HDCP-compliant</p> <p>Signal cables (1) detachable, VGA 15-pin D-shell at each end, analog, 1.8 meter (2) detachable, DisplayPort at each end, digital, 1.8 meter</p> <p>Mounting features Wall or desk mounting using the Extend Arm or third-party accessories, 100mm x 100mm mount Security Security keyhole for attachment of optional cable lock (Kensington® lock-compatible)</p>					
<p>Ship group Monitor with stand, Safety and Warranty Information, 1.8 meter analog signal cable, 1.8 meter DP signal cable, 1.8 meter USB signal cable, 1.8 meter black power cord</p>					
<p style="text-align: center;">Limited Warranty</p> <p>See details at http://support.lenovo.com/en_US/guides-and-manuals/detail.page?DocID=UM008281</p>	<p style="text-align: center;">Accessories</p> <table border="0"> <tr> <td>Kensington MicroSaver Cable Lock</td> <td style="text-align: right;">73P2582</td> </tr> <tr> <td>Kensington Twin Head Cable Lock</td> <td style="text-align: right;">45K1620</td> </tr> </table> <p>See details at www.lenovo.com/support/monitoraccessories</p> <p>See all monitors at www.lenovo.com/thinkvision</p>	Kensington MicroSaver Cable Lock	73P2582	Kensington Twin Head Cable Lock	45K1620
Kensington MicroSaver Cable Lock	73P2582				
Kensington Twin Head Cable Lock	45K1620				



<p>Name T2224z Wide Flat Panel Monitor Bezel color Raven black Type-model 60F5MAR6US / 60F5MAT6US / 60F5MAT6EU Panel TFT-LCD, In-Plane Switching (IPS), White LED backlight</p> <p>Viewable image size 21.5" (546mm) diagonal Max view area (W x H) 18.74" x 10.54" (476.1mm x 267.8mm) Native resolution 1920x1080 Aspect ratio 16:9 Pixel pitch (mm) 0.248 x 0.248 mm Dot/Pixel per Inch 102 dpi Brightness 250 nits or cd/m² (typical) Contrast ratio 1000:1 (typical) Pixel response time 7ms (typical) Color gamut 72% Viewing angle at 10:1 CR 178° (+/- 89°) horizontal, 178° (+/- 89°) vertical Stand Tilt, swivel, pivot, and height adjustable stand Bezel width <i>Sides:</i> 0.69" (17.6mm) Dimensions (HxWxD) 14.08" H x 20.19" W x 9.55" D; 357.8mm H x 512.9mm W x 242.7mm D</p> <p>Power supply 21 watts typical, 25 watts maximum (without USB 3.0 hub), 45 watts maximum (with USB 3.0 hub), <0.5 watts standby/suspend, universal, integrated (no external brick-like power supply)</p> <p>Weight 10.63 lb; 4.83 kg Limited warranty 3 year (includes backlight) Available date March 2015</p>	<p style="text-align: center;">Features</p> <ul style="list-style-type: none"> • Widescreen 21.5-inch monitor • Supports 1920x1080 resolution • Supports ThinkCentre Tiny Clamp Bracket • Supports optional soundbar • Includes dual input connection for attachment to two systems concurrently (analog and digital) • EPEAT Gold certified • Microsoft® Windows® 7 certified • Microsoft Windows 8 / Windows 8.1 certified • Microsoft Windows 10 certified 				
<p>VESA-compliant VESA DDC2B/CI Power management ENERGY STAR® qualified Ergonomics ISO 9241-307 Emission standards FCC Class B Environmental TCO Displays 7.0, TCO Certified Edge 2.0, WEEE, RoHS, EPEAT™ Gold rating</p>	<div style="text-align: center;">  <p>ThinkVision T2224z Wide Monitor</p> </div>				
<p>Preset resolutions VGA: 640x350, 640x480, 720x400 SVGA: 800x600 XGA: 1024x768, 1152x864 SXGA: 1280x1024 WXGA: 1280x768, 1280x800, 1366x768 WXGA+: 1440x900 WSXGA+: 1680x1050 Full HD: 1920x1080</p> <p>Presets / user settings Standard presets: 27; user settings: 20</p>					
<p>Viewing adjustments <i>Tilt:</i> 30° back, -5° forward; <i>lift:</i> 4.3" (110mm); <i>swivel:</i> +/-45°; detachable stand Rotating screen Screen pivots 90 degrees from landscape to portrait On screen display On screen display with digital user controls (8 languages) Control features Direct access (buttons on front) for automatic image setup, dual input and brightness USB hub USB 3.0 Hub: 1 port into PC (USB 3.0); 2 ports for accessories (2 USB 3.0) Multimedia Integrated digital speakers (3 watts x 2) Camera Integrated camera (Full HD) and digital dual array microphone Multiple input Dual input (two different PCs attach to two different connectors; one PC shows image; select via button) Monitor connectors (1) VGA 15-pin D-shell, analog, blue (2) HDMI (1.4), digital, HDCP-compliant (3) DisplayPort, digital, black, HDCP-compliant</p> <p>Signal cables (1) detachable, VGA 15-pin D-shell at each end, analog, 1.8 meter (2) detachable, DisplayPort at each end, digital, 1.8 meter</p> <p>Mounting features Wall or desk mounting using the Extend Arm or third-party accessories, 100mm x 100mm mount Security Security keyhole for attachment of optional cable lock (Kensington® lock-compatible)</p>					
<p>Ship group Monitor with stand, Safety and Warranty Information, 1.8 meter analog signal cable, 1.8 meter DP signal cable, 1.8 meter USB signal cable, 1.8 meter black power cord</p>					
<p style="text-align: center;">Limited Warranty</p> <p>See details at http://support.lenovo.com/en_US/guides-and-manuals/detail.page?DocID=UM008281</p>	<p style="text-align: center;">Accessories</p> <table border="0"> <tr> <td>Kensington MicroSaver Cable Lock</td> <td style="text-align: right;">73P2582</td> </tr> <tr> <td>Kensington Twin Head Cable Lock</td> <td style="text-align: right;">45K1620</td> </tr> </table> <p>See details at www.lenovo.com/support/monitoraccessories</p> <p>See all monitors at www.lenovo.com/thinkvision</p>	Kensington MicroSaver Cable Lock	73P2582	Kensington Twin Head Cable Lock	45K1620
Kensington MicroSaver Cable Lock	73P2582				
Kensington Twin Head Cable Lock	45K1620				



<p>Name T2254p Wide Flat Panel Monitor Bezel color Raven black Type-model 60CCMAR2US / 60CCMAT2US / 60CCMAT2EU Panel TFT-LCD, twisted nematic (TN), White LED backlight Viewable image size 22.0" (559mm) diagonal Max view area (W x H) 18.70" x 11.70" (473.8mm x 296.1mm) Native resolution 1680x1050 Aspect ratio 16:10 Pixel pitch (mm) 0.282 x 0.282 mm Dot/Pixel per Inch 90 dpi Brightness 250 nits or cd/m² (typical) Contrast ratio 1000:1 (typical) Pixel response time 5ms (typical) Color gamut 72% Viewing angle at 10:1 CR 170° (+/- 85°) horizontal, 160° (+/- 80°) vertical Stand Tilt, swivel, pivot, and height adjustable stand Bezel width Sides: 0.67" (17.1mm) Dimensions (HxWxD) 14.63" H x 20.01" W x 9.55" D; 371.7mm H x 509.3mm W x 242.7mm D Power supply 20 watts typical, 25 watts maximum, <0.5 watts standby/suspend, universal, integrated (no external brick-like power supply) Weight 10.14 lb; 4.60 kg Limited warranty 3 year (includes backlight) Available date March 2015</p>	<p style="text-align: center;">Features</p> <ul style="list-style-type: none"> • Widescreen 22.0-inch monitor • Supports 1680x1050 resolution • Supports ThinkCentre Tiny Clamp Bracket • Supports optional soundbar • Includes dual input connection for attachment to two systems concurrently (analog and digital) • EPEAT Gold certified • Microsoft® Windows® 7 certified • Microsoft Windows 8 / Windows 8.1 certified • Microsoft Windows 10 certified 				
<p>VESA-compliant VESA DDC2B/CI Power management ENERGY STAR® qualified Ergonomics ISO 9241-307 Emission standards FCC Class B Environmental TCO Displays 7.0, TCO Certified Edge 2.0, WEEE, RoHS, EPEAT™ Gold rating</p>	<div style="text-align: center;">  <p>ThinkVision T2254p Wide Monitor</p> </div>				
<p>Preset resolutions VGA: 640x350, 640x480, 720x400 SVGA: 800x600 XGA: 1024x768, 1152x864 SXGA: 1280x1024 WXGA: 1280x768, 1280x800, 1366x768 WXGA+: 1440x900 WSXGA+: 1600x900, 1680x1050 Presets / user settings Standard presets: 28; user settings: 20</p>					
<p>Viewing adjustments Tilt: 30° back, -5° forward; lift: 4.3" (110mm); swivel: +/-45°; detachable stand Rotating screen Screen pivots 90 degrees from landscape to portrait On screen display On screen display with digital user controls (8 languages) Control features Direct access (buttons on front) for automatic image setup, dual input and brightness USB hub None Multiple input Dual input (two different PCs attach to two different connectors; one PC shows image; select via button) Monitor connectors (1) VGA 15-pin D-shell, analog, blue (2) HDMI (1.4), digital, HDCP-compliant (3) DisplayPort, digital, black, HDCP-compliant Signal cables (1) detachable, VGA 15-pin D-shell at each end, analog, 1.8 meter (2) detachable, DisplayPort at each end, digital, 1.8 meter Mounting features Wall or desk mounting using the Extend Arm or third-party accessories, 100mm x 100mm mount Security Security keyhole for attachment of optional cable lock (Kensington® lock-compatible)</p>					
<p>Ship group Monitor with stand, Safety and Warranty Information, 1.8 meter analog signal cable, 1.8 meter DP signal cable, 1.8 meter black power cord</p>					
<p style="text-align: center;">Limited Warranty</p> <p>See details at http://support.lenovo.com/en_US/guides-and-manuals/detail.page?DocID=UM008281</p>	<p style="text-align: center;">Accessories</p> <table border="0"> <tr> <td>Kensington MicroSaver Cable Lock</td> <td style="text-align: right;">73P2582</td> </tr> <tr> <td>Kensington Twin Head Cable Lock</td> <td style="text-align: right;">45K1620</td> </tr> </table> <p>See details at www.lenovo.com/support/monitoraccessories</p> <p>See all monitors at www.lenovo.com/thinkvision</p>	Kensington MicroSaver Cable Lock	73P2582	Kensington Twin Head Cable Lock	45K1620
Kensington MicroSaver Cable Lock	73P2582				
Kensington Twin Head Cable Lock	45K1620				



<p>Name T2324d Wide Flat Panel Monitor Bezel color Black Type-model 60F3JAR2US / 60F3JAT2US / 60F3JAT2EU Panel TFT-LCD, twisted nematic (TN), White LED backlight Viewable image size 23.0" (584mm) diagonal Max view area (W x H) 20.07" x 11.29" (509.8mm x 286.7mm) Native resolution 1920x1080 Aspect ratio 16:9 Pixel pitch (mm) 0.2655 x 0.2655 mm Dot/Pixel per Inch 96 dpi Brightness 250 nits or cd/m² (typical) Contrast ratio 1000:1 (typical) Pixel response time 5ms (typical) Color gamut 72% Viewing angle at 10:1 CR 170° (+/- 85°) horizontal, 160° (+/- 80°) vertical Stand Tilt stand Bezel width Sides: 0.68" (17.3mm) Dimensions (HxWxD) 15.75" H x 21.48" W x 8.06" D; 400.3mm H x 545.8mm W x 204.9mm D Power supply 20 watts typical, 27 watts maximum <0.3 watts standby/suspend, universal, integrated (no external brick-like power supply) Weight 7.06 lb; 3.20 kg Limited warranty 3 year (includes backlight) Available date June 2016</p>	<p style="text-align: center;">Features</p> <ul style="list-style-type: none"> • Widescreen 23.0-inch monitor • Supports 1920x1080 resolution • Supports optional soundbar • Supports ThinkCentre Tiny via VESA back mount • Includes dual input connection for attachment to two systems concurrently (analog and digital) • EPEAT Gold certified • Microsoft® Windows® 7 certified • Microsoft Windows 10 certified 				
<p>VESA-compliant VESA DDC2B/CI Power management ENERGY STAR® qualified Ergonomics ISO 9241-307 Emission standards FCC Class B Environmental TCO Displays 7.0, TCO Certified Edge 2.0, WEEE, RoHS, EPEAT™ Gold rating</p>	<div style="text-align: center;">  <p>ThinkVision T2324d Wide Monitor</p> </div>				
<p>Preset resolutions VGA: 640x350, 640x480, 720x400 SVGA: 800x600 XGA: 1024x768, 1152x864 SXGA: 1280x1024 WXGA: 1280x768, 1280x800, 1366x768 WXGA+: 1440x900 WSXGA+: 1680x1050 Full HD: 1920x1080</p> <p>Presets / user settings Standard presets: 26; user settings: 16</p>					
<p>Viewing adjustments Tilt: 22° back, -5° Rotating screen None On screen display On screen display with digital user controls (8 languages) Control features Direct access (buttons on front) for automatic image setup, dual input and brightness USB hub None Multiple input Dual input (two different PCs attach to two different connectors; one PC shows image; select via button) Monitor connectors (1) VGA 15-pin D-shell, analog, blue (2) DisplayPort, digital, black, HDCP-compliant Signal cables (1) detachable, VGA 15-pin D-shell at each end, analog, 1.8 meter (2) detachable, DisplayPort at each end, digital, 1.8 meter Mounting features Wall or desk mounting using the Extend Arm or third-party accessories, 100mm x 100mm mount Security Security keyhole for attachment of optional cable lock (Kensington® lock-compatible)</p>					
<p>Ship group Monitor with stand, Safety and Warranty Information, 1.8 meter analog signal cable, 1.8 meter DP signal cable, 1.8 meter black power cord</p>	<p style="text-align: center;">Limited Warranty</p> <p>See details at http://support.lenovo.com/en_US/guides-and-manuals/detail.page?DocID=UM008281</p> <p style="text-align: center;">Accessories</p> <table border="0" style="width: 100%;"> <tr> <td>Kensington MicroSaver Cable Lock</td> <td style="text-align: right;">73P2582</td> </tr> <tr> <td>Kensington Twin Head Cable Lock</td> <td style="text-align: right;">45K1620</td> </tr> </table> <p>See details at www.lenovo.com/support/monitoraccessories</p> <p>See all monitors at www.lenovo.com/thinkvision</p>	Kensington MicroSaver Cable Lock	73P2582	Kensington Twin Head Cable Lock	45K1620
Kensington MicroSaver Cable Lock	73P2582				
Kensington Twin Head Cable Lock	45K1620				



<p>Name T2324p Wide Flat Panel Monitor Bezel color Raven black Type-model 60GBMAR1US / 60GBMAT1US / 60GBMAT1EU Panel TFT-LCD, In-Plane Switching (IPS), White LED backlight</p> <p>Viewable image size 23.0" (584mm) diagonal Max view area (W x H) 20.05" x 11.28" (509.2mm x 286.4mm) Native resolution 1920x1080 Aspect ratio 16:9 Pixel pitch (mm) 0.2652 x 0.2652 mm Dot/Pixel per Inch 96 dpi Brightness 250 nits or cd/m² (typical) Contrast ratio 1000:1 (typical) Pixel response time 7ms (typical) Color gamut 72% Viewing angle at 10:1 CR 178° (+/- 89°) horizontal, 178° (+/- 89°) vertical Stand Tilt, swivel, pivot, and height adjustable stand Bezel width Sides: 0.68" (17.3mm) Dimensions (HxWxD) 14.27" H x 21.48" W x 10.39" D; 362.5mm H x 545.8mm W x 264.2mm D</p> <p>Power supply 21 watts typical, 25 watts maximum (without USB 3.0 hub), 49 watts maximum (with USB 3.0 hub), <0.5 watts standby/suspend, universal, integrated (no external brick-like power supply)</p> <p>Weight 11.90 lb; 5.40 kg Limited warranty 3 year (includes backlight) Available date March 2015</p>	<p style="text-align: center;">Features</p> <ul style="list-style-type: none"> • Widescreen 23.0-inch monitor • Supports 1920x1080 resolution • Supports ThinkCentre Tiny Clamp Bracket • Supports optional soundbar • Includes dual input connection for attachment to two systems concurrently (analog and digital) • EPEAT Gold certified • Microsoft® Windows® 7 certified • Microsoft Windows 8 / Windows 8.1 certified • Microsoft Windows 10 certified 				
<p>VESA-compliant VESA DDC2B/CI Power management ENERGY STAR® qualified Ergonomics ISO 9241-307 Emission standards FCC Class B Environmental TCO Displays 6.0, TCO Certified Edge 2.0, WEEE, RoHS, EPEAT™ Gold rating</p>	<div style="text-align: center;">  <p>ThinkVision T2324p Wide Monitor</p> </div>				
<p>Preset resolutions VGA: 640x350, 640x480, 720x400 SVGA: 800x600 XGA: 1024x768, 1152x864 SXGA: 1280x1024 WXGA: 1280x768, 1280x800, 1366x768 WXGA+: 1440x900 WSXGA+: 1680x1050 Full HD: 1920x1080</p> <p>Presets / user settings Standard presets: 24; user settings: 20</p>					
<p>Viewing adjustments Tilt: 30° back, -5° forward; lift: 4.3" (110mm); swivel: +/-45°; detachable stand Rotating screen Screen pivots 90 degrees from landscape to portrait On screen display On screen display with digital user controls (8 languages) Control features Direct access (buttons on front) for automatic image setup, dual input and brightness USB hub USB 3.0 Hub: 1 port into PC (USB 3.0); 4 ports for accessories (4 USB 3.0) Multiple input Dual input (two different PCs attach to two different connectors; one PC shows image; select via button) Monitor connectors (1) VGA 15-pin D-shell, analog, blue (2) HDMI (1.4), digital, HDCP-compliant (3) DisplayPort, digital, black, HDCP-compliant</p> <p>Signal cables (1) detachable, VGA 15-pin D-shell at each end, analog, 1.8 meter (2) detachable, DisplayPort at each end, digital, 1.8 meter</p> <p>Mounting features Wall or desk mounting using the Extend Arm or third-party accessories, 100mm x 100mm mount Security Security keyhole for attachment of optional cable lock (Kensington® lock-compatible)</p>					
<p>Ship group Monitor with stand, Safety and Warranty Information, 1.8 meter analog signal cable, 1.8 meter DP signal cable, 1.8 meter USB signal cable, 1.8 meter black power cord</p>					
<p style="text-align: center;">Limited Warranty</p> <p>See details at http://support.lenovo.com/en_US/guides-and-manuals/detail.page?DocID=UM008281</p>	<p style="text-align: center;">Accessories</p> <table border="0"> <tr> <td>Kensington MicroSaver Cable Lock</td> <td style="text-align: right;">73P2582</td> </tr> <tr> <td>Kensington Twin Head Cable Lock</td> <td style="text-align: right;">45K1620</td> </tr> </table> <p>See details at www.lenovo.com/support/monitoraccessories</p> <p>See all monitors at www.lenovo.com/thinkvision</p>	Kensington MicroSaver Cable Lock	73P2582	Kensington Twin Head Cable Lock	45K1620
Kensington MicroSaver Cable Lock	73P2582				
Kensington Twin Head Cable Lock	45K1620				



<p>Name T2364t Wide Flat Panel Monitor Bezel color Black Type-model 60E9MAR1US / 60E9MAT1US / 60E9MAT1EU Panel TFT-LCD, In-Plane Switching (IPS), White LED backlight</p> <p>Viewable image size 23.0" (584mm) diagonal Max view area (W x H) 20.05" x 11.28" (509.2mm x 286.4mm) Native resolution 1920x1080</p> <p>Touch Supports 10-point touch</p> <p>Aspect ratio 16:9 Pixel pitch (mm) 0.2652 x 0.2652 mm Dot/Pixel per Inch 95 dpi Brightness 250 nits or cd/m² (typical) Contrast ratio 1000:1 (typical) Pixel response time 7ms (typical) Color gamut 72% Viewing angle at 10:1 CR 178° (+/- 89°) horizontal, 178° (+/- 89°) vertical</p> <p>Stand Tilt adjustable stand Bezel width <i>Sides:</i> 0.079" (2.0mm) Dimensions (HxWxD) 12.53" H x 20.56" W x 2.86" D; 318.2mm H x 522.2mm W x 72.7mm D</p> <p>Power supply 22 watts typical, 45 watts maximum, <0.5 watts standby/suspend, universal, integrated (no external brick-like power supply)</p> <p>Weight 9.24 lb; 4.32 kg Limited warranty 3 year (includes backlight) Available date June 2015</p>	<p style="text-align: center;">Features</p> <ul style="list-style-type: none"> • Widescreen 23.0-inch monitor • Supports 1920x1080 resolution • Includes dual input connection for attachment to two systems concurrently • EPEAT Gold certified • 10-point touch screen • Microsoft® Windows® 7 certified • Microsoft Windows 10 certified
<p>VESA-compliant VESA DDC2B/CI Power management ENERGY STAR® qualified Ergonomics ISO 9241-307 Emission standards FCC Class B Environmental TCO Displays 7.0, TCO Certified Edge 2.0, WEEE, RoHS, EPEAT™ Gold rating</p>	<div data-bbox="954 457 1487 779" data-label="Image"> </div> <div data-bbox="943 821 1451 1066" data-label="Image"> </div> <p style="text-align: center;">ThinkVision T2364t</p>
<p>Preset resolutions VGA: 640x350, 640x480, 720x400, 700x570 SVGA: 800x600, 832x624 XGA: 1024x768, 1152x864 SXGA: 1280x1024 WXGA: 1366x768 WXGA+: 1440x900, 1600x900 WSXGA+: 1680x1050 Full HD: 1920x1080</p> <p>Presets / user settings User settings: 20</p>	<p>Viewing adjustments <i>Tilt:</i> 10° - 70° degrees; detachable stand Rotating screen None On screen display On screen display with digital user controls (8 languages) Control features Direct access (buttons on front) for automatic image setup, dual input and brightness USB hub USB 3.0 Hub: 1 port into PC (USB 3.0); 3 ports for accessories (3 USB 3.0) Multiple input Dual input (two different PCs attach to two different connectors; one PC shows image; select via button) Monitor connectors (1) VGA 15-pin D-shell, analog, blue (2) HDMI (1.4), digital, HDCP-compliant (3) DisplayPort, digital, black, HDCP-compliant</p> <p>Signal cables (1) detachable, VGA 15-pin D-shell at each end, analog, 1.8 meter (2) detachable, HDMI at each end, digital, 1.8 meter (3) detachable, DisplayPort at each end, digital, 1.8 meter</p> <p>Mounting features Wall or desk mounting using the Extend Arm or third-party accessories, 100mm x 100mm mount Security Security keyhole for attachment of optional cable lock (Kensington® lock-compatible)</p> <p>Ship group Monitor with stand, Safety and Warranty Information, 1.8 meter analog signal cable, 1.8 meter HDMI cable, 1.8 meter DisplayPort cable, 1.8 meter USB signal cable, 1.8 meter black power cord</p>

<p style="text-align: center;">Limited Warranty</p> <p>See details at http://support.lenovo.com/en_US/guides-and-manuals/detail.page?DocID=UM008281</p>	<p style="text-align: center;">Accessories</p> <table border="0"> <tr> <td>Kensington MicroSaver Cable Lock</td> <td style="text-align: right;">73P2582</td> </tr> <tr> <td>Kensington Twin Head Cable Lock</td> <td style="text-align: right;">45K1620</td> </tr> </table> <p>See details at www.lenovo.com/support/monitoraccessories</p> <p>See all monitors at www.lenovo.com/thinkvision</p>	Kensington MicroSaver Cable Lock	73P2582	Kensington Twin Head Cable Lock	45K1620
Kensington MicroSaver Cable Lock	73P2582				
Kensington Twin Head Cable Lock	45K1620				



<p>Name T2424p Wide Flat Panel Monitor Bezel color Raven black Type-model 60F7MAR1US / 60F7MAT1US / 60C8MAT1EU Panel TFT-LCD, In-Plane Switching (IPS), White LED backlight</p> <p>Viewable image size 23.8" (604.7mm) diagonal Max view area (W x H) 20.75" x 11.67" (527.0mm x 296.5mm) Native resolution 1920x1080 Aspect ratio 16:9 Pixel pitch (mm) 0.2745 x 0.2745 mm Dot/Pixel per Inch 93 dpi Brightness 250 nits or cd/m² (typical) Contrast ratio 1000:1 (typical) Pixel response time 7ms (typical) Color gamut 72% Viewing angle at 10:1 CR 178° (+/- 89°) horizontal, 178° (+/- 89°) vertical Stand Tilt, swivel, pivot, and height adjustable stand Bezel width Sides: 0.69" (17.5mm) Dimensions (HxWxD) 14.67" H x 22.19" W x 10.39" D; 372.5mm H x 563.6mm W x 264.2mm D</p> <p>Power supply 22 watts typical, 26 watts maximum (without USB 3.0 hub), 54 watts maximum (with USB 3.0 hub), <0.5 watts standby/suspend, universal, integrated (no external brick-like power supply) Weight 12.90 lb; 5.85 kg Limited warranty 3 year (includes backlight) Available date March 2015</p>	<p style="text-align: center;">Features</p> <ul style="list-style-type: none"> • Widescreen 23.8-inch monitor • Supports 1920x1080 resolution • Supports ThinkCentre Tiny Clamp Bracket • Supports optional soundbar • Includes dual input connection for attachment to two systems concurrently (analog and digital) • EPEAT Gold certified • Microsoft® Windows® 7 certified • Microsoft Windows 8 / Windows 8.1 certified • Microsoft Windows 10 certified 				
<p>VESA-compliant VESA DDC2B/CI Power management ENERGY STAR® qualified Ergonomics ISO 9241-307 Emission standards FCC Class B Environmental TCO Displays 7.0, TCO Certified Edge 2.0, WEEE, RoHS, EPEAT™ Gold rating</p> <p>Preset resolutions VGA: 640x350, 640x480, 720x400 SVGA: 800x600 XGA: 1024x768, 1152x864 SXGA: 1280x1024 WXGA: 1366x768 WXGA+: 1440x900, 1600x900 WSXGA+: 1680x1050 Full HD: 1920x1080</p> <p>Presets / user settings Standard presets: 22; user settings: 22</p>	<div style="text-align: center;">  <p>ThinkVision T2424p Wide Monitor</p> </div>				
<p>Viewing adjustments Tilt: 30° back, -5° forward; lift: 4.3" (110mm); swivel: +/-45°; detachable stand Rotating screen Screen pivots 90 degrees from landscape to portrait On screen display On screen display with digital user controls (8 languages) Control features Direct access (buttons on front) for automatic image setup, dual input and brightness USB hub USB 3.0 Hub: 1 port into PC (USB 3.0); 4 ports for accessories (4 USB 3.0) Multiple input Dual input (two different PCs attach to two different connectors; one PC shows image; select via button) Monitor connectors (1) VGA 15-pin D-shell, analog, blue (2) HDMI (1.4), digital, HDCP-compliant (3) DisplayPort, digital, black, HDCP-compliant</p> <p>Signal cables (1) detachable, VGA 15-pin D-shell at each end, analog, 1.8 meter (2) detachable, DisplayPort at each end, digital, 1.8 meter</p> <p>Mounting features Wall or desk mounting using the Extend Arm or third-party accessories, 100mm x 100mm mount Security Security keyhole for attachment of optional cable lock (Kensington® lock-compatible)</p>					
<p>Ship group Monitor with stand, Safety and Warranty Information, 1.8 meter analog signal cable, 1.8 meter DP signal cable, 1.8 meter USB signal cable, 1.8 meter black power cord</p>					
<p style="text-align: center;">Limited Warranty</p> <p>See details at http://support.lenovo.com/en_US/guides-and-manuals/detail.page?DocID=UM008281</p>	<p style="text-align: center;">Accessories</p> <table border="0"> <tr> <td>Kensington MicroSaver Cable Lock</td> <td style="text-align: right;">73P2582</td> </tr> <tr> <td>Kensington Twin Head Cable Lock</td> <td style="text-align: right;">45K1620</td> </tr> </table> <p>See details at www.lenovo.com/support/monitoraccessories</p> <p>See all monitors at www.lenovo.com/thinkvision</p>	Kensington MicroSaver Cable Lock	73P2582	Kensington Twin Head Cable Lock	45K1620
Kensington MicroSaver Cable Lock	73P2582				
Kensington Twin Head Cable Lock	45K1620				



<p>Name T2424z Wide Flat Panel Monitor Bezel color Raven black Type-model 60F8MAR1US / 60F8MAT1US / 60F8MAT1EU Panel TFT-LCD, In-Plane Switching (IPS), White LED backlight</p> <p>Viewable image size 23.8" (604.7mm) diagonal Max view area (W x H) 20.75" x 11.67" (527.0mm x 296.5mm) Native resolution 1920x1080 Aspect ratio 16:9 Pixel pitch (mm) 0.2745 x 0.2745 mm Dot/Pixel per Inch 92 dpi Brightness 250 nits or cd/m² (typical) Contrast ratio 1000:1 (typical) Pixel response time 7ms (typical) Color gamut 72% Viewing angle at 10:1 CR 178° (+/- 89°) horizontal, 178° (+/- 89°) vertical Stand Tilt, swivel, pivot, and height adjustable stand Bezel width Sides: 0.69" (17.5mm) Dimensions (HxWxD) 19.53" H x 22.19" W x 10.39" D; 496.0mm H x 563.6mm W x 264.2mm D</p> <p>Power supply 22 watts typical, 40 watts maximum (without USB 3.0 hub), <0.5 watts standby/suspend, universal, integrated (no external brick-like power supply)</p> <p>Weight 12.90 lb; 5.85 kg Limited warranty 3 year (includes backlight) Available date June 2016</p>	<p style="text-align: center;">Features</p> <ul style="list-style-type: none"> • Widescreen 23.8-inch monitor • Supports 1920x1080 resolution • Supports ThinkCentre Tiny Clamp Bracket • Includes dual input connection for attachment to two systems concurrently (analog and digital) • EPEAT Gold certified • Microsoft® Windows® 7 certified • Microsoft Windows 8 / Windows 8.1 certified • Microsoft Windows 10 certified 				
<p>VESA-compliant VESA DDC2B/CI Power management ENERGY STAR® qualified Ergonomics ISO 9241-307 Emission standards FCC Class B Environmental TCO Displays 7.0, TCO Certified Edge 2.0, WEEE, RoHS, EPEAT™ Gold rating</p>	<div style="text-align: center;">  <p>ThinkVision T2424z Wide Monitor</p> </div>				
<p>Preset resolutions VGA: 640x350, 640x480, 720x400 SVGA: 800x600 XGA: 1024x768, 1152x864 SXGA: 1280x1024 WXGA+: 1440x900, 1600x900 WSXGA+: 1680x1050 Full HD: 1920x1080</p> <p>Presets / user settings Standard presets: 31; user settings: 20</p>					
<p>Viewing adjustments Tilt: 30° back, -5° forward; lift: 4.3" (110mm); swivel: +/-45°; detachable stand Rotating screen Screen pivots 90 degrees from landscape to portrait On screen display On screen display with digital user controls (8 languages) Control features Direct access (buttons on front) for automatic image setup, dual input and brightness USB hub USB 3.0 Hub: 1 port into PC (USB 3.0); 2 ports for accessories (2 USB 3.0) Multimedia Integrated digital speakers (3 watts x 2) Camera Integrated camera (Full HD) and digital dual array microphone Multiple input Dual input (two different PCs attach to two different connectors; one PC shows image; select via button) Monitor connectors (1) VGA 15-pin D-shell, analog, blue (2) HDMI (1.4), digital, HDCP-compliant (3) DisplayPort, digital, black, HDCP-compliant</p> <p>Signal cables (1) detachable, VGA 15-pin D-shell at each end, analog, 1.8 meter (2) detachable, DisplayPort at each end, digital, 1.8 meter</p> <p>Mounting features Wall or desk mounting using the Extend Arm or third-party accessories, 100mm x 100mm mount Security Security keyhole for attachment of optional cable lock (Kensington® lock-compatible)</p>					
<p>Ship group Monitor with stand, Safety and Warranty Information, 1.8 meter analog signal cable, 1.8 meter DP signal cable, 1.8 meter USB signal cable, 1.8 meter black power cord</p>	<p style="text-align: center;">Accessories</p> <table border="0" style="width: 100%;"> <tr> <td>Kensington MicroSaver Cable Lock</td> <td style="text-align: right;">73P2582</td> </tr> <tr> <td>Kensington Twin Head Cable Lock</td> <td style="text-align: right;">45K1620</td> </tr> </table> <p>See details at www.lenovo.com/support/monitoraccessories</p> <p>See all monitors at www.lenovo.com/thinkvision</p>	Kensington MicroSaver Cable Lock	73P2582	Kensington Twin Head Cable Lock	45K1620
Kensington MicroSaver Cable Lock	73P2582				
Kensington Twin Head Cable Lock	45K1620				
<p style="text-align: center;">Limited Warranty</p> <p>See details at http://support.lenovo.com/en_US/guides-and-manuals/detail.page?DocID=UM008281</p>					



<p>Name T2454p Wide Flat Panel Monitor Bezel color Raven black Type-model 60F9MAR1US / 60F9MAT1US / 60F9MAT1EU Panel TFT-LCD, In-Plane Switching (IPS), White LED backlight</p> <p>Viewable image size 24.0" (609.6mm) diagonal Max view area (W x H) 20.41" x 12.76" (518.4mm x 324.0mm) Native resolution 1920x1200 Aspect ratio 16:10 Pixel pitch (mm) 0.270 x 0.270 mm Dot/Pixel per Inch 94 dpi Brightness 300 nits or cd/m² (typical) Contrast ratio 1000:1 (typical) Pixel response time 7ms (typical) Color gamut 77.4% Viewing angle at 10:1 CR 178° (+/- 89°) horizontal, 178° (+/- 89°) vertical Stand Tilt, swivel, pivot, and height adjustable stand Bezel width Sides: 0.74" (18.8mm) Dimensions (HxWxD) 15.85" H x 21.94" W x 10.39" D; 402.5mm H x 557.4mm W x 264.2mm D</p> <p>Power supply 24 watts typical, 27 watts maximum (without USB 3.0 hub), 54 watts maximum (with USB 3.0 hub), <0.5 watts standby/suspend, universal, integrated (no external brick-like power supply) Weight 13.60 lb; 6.15 kg Limited warranty 3 year (includes backlight) Available date March 2015</p>	<p style="text-align: center;">Features</p> <ul style="list-style-type: none"> • Widescreen 24.0-inch monitor • Supports 1920x1200 resolution • Supports ThinkCentre Tiny Clamp Bracket • Supports optional soundbar • Includes dual input connection for attachment to two systems concurrently (analog and digital) • EPEAT Gold certified • Microsoft® Windows® 7 certified • Microsoft Windows 8 / Windows 8.1 certified • Microsoft Windows 10 certified 				
<p>VESA-compliant VESA DDC2B/CI Power management ENERGY STAR® qualified Ergonomics ISO 9241-307 Emission standards FCC Class B Environmental TCO Displays 7.0, TCO Certified Edge 2.0, WEEE, RoHS, EPEAT™ Gold rating</p> <p>Preset resolutions VGA: 640x350, 640x480, 720x400 SVGA: 800x600 XGA: 1024x768 SXGA: 1280x1024 WXGA: 1280x720, 1280x768, 1280x800 WXGA+: 1440x900 WSXGA+: 1680x1050, 1600x1200 Full HD: 1920x1080, 1920x1200</p> <p>Presets / user settings Standard presets: 21; user settings: 20</p>	<div style="text-align: center;">  <p>ThinkVision T2454p Wide Monitor</p> </div>				
<p>Viewing adjustments Tilt: 30° back, -5° forward; lift: 4.3" (110mm); swivel: +/-45°; detachable stand Rotating screen Screen pivots 90 degrees from landscape to portrait On screen display On screen display with digital user controls (8 languages) Control features Direct access (buttons on front) for automatic image setup, dual input and brightness USB hub USB 3.0 Hub: 1 port into PC (USB 3.0); 4 ports for accessories (4 USB 3.0) Multiple input Dual input (two different PCs attach to two different connectors; one PC shows image; select via button) Monitor connectors (1) VGA 15-pin D-shell, analog, blue (2) HDMI (1.4), digital, HDCP-compliant (3) DisplayPort, digital, black, HDCP-compliant</p> <p>Signal cables (1) detachable, VGA 15-pin D-shell at each end, analog, 1.8 meter (2) detachable, DisplayPort at each end, digital, 1.8 meter</p> <p>Mounting features Wall or desk mounting using the Extend Arm or third-party accessories, 100mm x 100mm mount Security Security keyhole for attachment of optional cable lock (Kensington® lock-compatible)</p>	<p>Ship group Monitor with stand, Safety and Warranty Information, 1.8 meter analog signal cable, 1.8 meter DisplayPort cable, 1.8 meter USB signal cable, 1.8 meter black power cord</p>				
<p style="text-align: center;">Limited Warranty</p> <p>See details at http://support.lenovo.com/en_US/guides-and-manuals/detail.page?DocID=UM008281</p>	<p style="text-align: center;">Accessories</p> <table border="0" style="width: 100%;"> <tr> <td>Kensington MicroSaver Cable Lock</td> <td style="text-align: right;">73P2582</td> </tr> <tr> <td>Kensington Twin Head Cable Lock</td> <td style="text-align: right;">45K1620</td> </tr> </table> <p>See details at www.lenovo.com/support/monitoraccessories</p> <p>See all monitors at www.lenovo.com/thinkvision</p>	Kensington MicroSaver Cable Lock	73P2582	Kensington Twin Head Cable Lock	45K1620
Kensington MicroSaver Cable Lock	73P2582				
Kensington Twin Head Cable Lock	45K1620				



<p>Name X24 Wide Flat Panel Monitor Bezel color Raven black Type-model 60FAGAR1US / 60FAGAT1US / 60FAGAT1EU Panel TFT-LCD, AH-IPS (In-Plane Switching), White LED backlight Viewable image size 23.8" (604.5mm) diagonal Max view area (W x H) 20.75" x 11.67" (527.0mm x 296.5mm) Native resolution 1920x1080 Aspect ratio 16:9 Pixel pitch (mm) 0.2745 x 0.2745 mm Dot/Pixel per Inch 92 dpi Brightness 250 nits or cd/m² (typical) Contrast ratio 1000:1 (typical) Pixel response time 7ms (typical) Color gamut 72% Viewing angle at 10:1 CR 178° (+/- 89°) horizontal, 178° (+/- 89°) vertical Stand Tilt stand Bezel width <i>Sides:</i> 0.08" (2.0mm) Dimensions (HxWxD) 16.25" H x 21.30" W x 8.66" D; 412.8mm H x 540.9mm W x 220.0mm D Power supply 20 watts typical, 27 watts maximum, <0.5 watts standby/suspend, universal, external power supply Weight 8.60 lb; 3.90 kg Limited warranty 3 year (includes backlight) Available date April 2015</p>	<p style="text-align: center;">Features</p> <ul style="list-style-type: none"> • Widescreen 23.8-inch monitor • Supports 1920x1080 resolution • Includes dual input connection for attachment to two systems concurrently (analog and digital) • EPEAT Silver certified • Microsoft® Windows® 7 certified • Microsoft Windows 8 / Windows 8.1 certified • Microsoft Windows 10 certified 				
<p>Power management ENERGY STAR® qualified Ergonomics ISO 9241-307 Emission standards FCC Class B Environmental TCO Displays 6.0, WEEE, RoHS, EPEAT™ Silver rating</p>	<div style="text-align: center;">  <p>ThinkVision X24 Wide Monitor</p> </div>				
<p>Preset resolutions VGA: 640x350, 640x480, 720x400 SVGA: 800x600 XGA: 1024x768 SXGA: 1280x1024 WXGA: 1366x768 WXGA+: 1440x900, 1600x900 WSXGA+: 1680x1050 Full HD: 1920x1080 Presets / user settings Standard presets: 20; user settings: 16</p>					
<p>Viewing adjustments <i>Tilt:</i> 22° back, -5° forward Rotating screen None On screen display On screen display with digital user controls Control features Direct access (buttons on side bezel) for dual input and brightness USB hub None Multiple input Dual input (two different PCs attach to two different connectors; one PC shows image; select via button) Monitor connectors (1) HDMI (1.4), digital, HDCP-compliant (2) DisplayPort, digital, black, HDCP-compliant Signal cables (1) detachable, HDMI at each end, digital, 1.8 meter (2) detachable, DisplayPort at each end, digital, 1.8 meter Mounting features None Security None</p>					
<p>Ship group Monitor with stand, Safety and Warranty Information, 1.8 meter HDMI signal cable (consumer channel only), 1.8 meter DisplayPort signal cable (commercial channel only), 1.8 meter black power cord</p>	<p style="text-align: center;">Limited Warranty</p> <p>See details at http://support.lenovo.com/en_US/guides-and-manuals/detail.page?DocID=UM008281</p> <p style="text-align: center;">Accessories</p> <table border="0"> <tr> <td>Kensington MicroSaver Cable Lock</td> <td style="text-align: right;">73P2582</td> </tr> <tr> <td>Kensington Twin Head Cable Lock</td> <td style="text-align: right;">45K1620</td> </tr> </table> <p>See details at www.lenovo.com/support/monitoraccessories</p> <p>See all monitors at www.lenovo.com/thinkvision</p>	Kensington MicroSaver Cable Lock	73P2582	Kensington Twin Head Cable Lock	45K1620
Kensington MicroSaver Cable Lock	73P2582				
Kensington Twin Head Cable Lock	45K1620				



<p>Name X24 Pro Wide Flat Panel Monitor Bezel color Black Type-model 60E4ECR1US / 60E4ECT1US / 60E4ECT1EU Panel TFT-LCD, AH-IPS (In-Plane Switching), White LED backlight Viewable image size 23.8" (604.5mm) diagonal Max view area (W x H) 20.75" x 11.67" (527.0mm x 296.5mm) Native resolution 1920x1080 Aspect ratio 16:9 Pixel pitch (mm) 0.2745 x 0.2745 mm Dot/Pixel per Inch 92 dpi Brightness 250 nits or cd/m² (typical) Contrast ratio 1000:1 (typical) Pixel response time 7ms (typical) Color gamut 72% Viewing angle at 10:1 CR 178° (+/- 89°) horizontal, 178° (+/- 89°) vertical Stand Tilt stand Bezel width <i>Sides:</i> 0.09" (2.3mm) Dimensions (HxWxD) 17.61" H x 21.30" W x 9.39" D; 447.4mm H x 540.9mm W x 238.4mm D Power supply 20 watts typical, 90 watts maximum, <0.5 watts standby/suspend, universal, external power supply Weight 9.26 lb; 4.20 kg Limited warranty 1 year (includes backlight) Available date July 2016</p>	<p style="text-align: center;">Features</p> <ul style="list-style-type: none"> • Widescreen 23.8-inch monitor • Supports 1920x1080 resolution • Includes dual input connection for attachment to two systems concurrently • EPEAT Silver certified • Intel RealSense 3D camera • Stereo speakers 3 watts x 2 • One cable docking through USB 3.1 Type C with power delivery • Windows Hello certified • Microsoft® Windows® 10 certified 				
<p>Power management ENERGY STAR® qualified Ergonomics ISO 9241-307 Emission standards FCC Class B Environmental TCO Displays 6.0, WEEE, RoHS, EPEAT™ Silver rating</p> <p>Preset resolutions VGA: 640x350, 640x480, 720x400 SVGA: 800x600 XGA: 1024x768 SXGA: 1280x1024 WXGA: 1366x768 WXGA+: 1440x900, 1600x900 WSXGA+: 1680x1050 Full HD: 1920x1080</p> <p>Presets / user settings Standard presets: 16; user settings: 20</p>	<div style="text-align: center;">  <p>ThinkVision X24 Pro Wide Monitor</p> </div>				
<p>Viewing adjustments <i>Tilt:</i> 22° back, -5° forward Rotating screen None On screen display On screen display with digital user controls Control features Direct access (buttons on side bezel) for dual input and brightness USB hub USB Hub: two USB 3.0 Type-C and one USB 3.0 ports Multimedia Integrated stereo speakers (3 watts x 2), built-in microphone Camera RealSense 3D camera SR300 Multiple input Dual input (two different PCs attach to two different connectors; one PC shows image; select via button) Monitor connectors (1) mDP, Mini DisplayPort, digital, HDCP-compliant (2) USB Type-C, digital Signal cables (1) detachable, mDP to DP, digital, 2.0 meter (2) DP to mDP adaptor (3) USB 3.0 cable Mounting features None Security Security keyhole for attachment of optional cable lock (Kensington® lock-compatible)</p>	<p>Ship group Monitor with stand, Safety and Warranty Information, 2.0 meter Mini DisplayPort to DisplayPort signal cable, ThinkPad 90W Square tip power adaptor</p>				
<p style="text-align: center;">Limited Warranty</p> <p>See details at http://support.lenovo.com/en_US/guides-and-manuals/detail.page?DocID=UM008281</p>	<p style="text-align: center;">Accessories</p> <table border="0"> <tr> <td>Kensington MicroSaver Cable Lock</td> <td style="text-align: right;">73P2582</td> </tr> <tr> <td>Kensington Twin Head Cable Lock</td> <td style="text-align: right;">45K1620</td> </tr> </table> <p>See details at www.lenovo.com/support/monitoraccessories</p> <p>See all monitors at www.lenovo.com/thinkvision</p>	Kensington MicroSaver Cable Lock	73P2582	Kensington Twin Head Cable Lock	45K1620
Kensington MicroSaver Cable Lock	73P2582				
Kensington Twin Head Cable Lock	45K1620				



<p>Name P27 Wide Flat Panel Monitor Case color Black Type-model 60E3GAR1US / 60E3GAT1US / 60E3GAT1EU Panel TFT-LCD, IPS (In-Plane Switching), White LED backlight Viewable image size 27" (684.7mm) diagonal Max view area (W x H) 23.49" x 13.21" (596.7mm x 335.7mm) Optimum resolution 3840x2160 Max pixel rate 600MHz Aspect ratio 16:9 Pixel pitch (mm) 0.16 x 0.16mm Dot/Pixel per Inch 163 dpi Brightness 300 nits or cd/m² (typical) Contrast ratio 1300:1 (typical) Pixel response time 6ms Color gamut 99% Viewing angle at 10:1 CR 178° horizontal, 178° vertical Stand Tilt, swivel, pivot, and height adjustable stand Bezel width Sides: 0.088" (2.23mm) Dimensions 18.59" H x 24.19" W x 11.81" D; (HxWxD, including stand) 472.3mm H x 614.5mm W x 299.9mm D Power supply 40 watts typical, 70 watts maximum (with USB), <0.5 watts sleep/off; <0.5 watts switch off Weight 15.12 lb; 6.86kg (including stand) Limited warranty⁴ 3 year Available date March 2016</p>	<p>Features</p> <ul style="list-style-type: none"> • 27-inch IPS LED backlight monitor with speaker • Supports 3840x2160 resolution • 5-Ports USB hub, support USB 3.0 • 3watts x 2 stereo speakers • Microsoft® Windows® 7 certified • Microsoft Windows 10 certified 						
<p>VESA-compliant² VESA DDC2B/CI Power management ENERGY STAR® 7.0 Ergonomics ISO 9241-307 Emission standards FCC Class B Environmental TCO Displays 7.0, RoHS, EPEAT™ Gold rating, ULE Gold</p>	 <p style="text-align: center;">ThinkVision P27 Monitor</p>						
<p>Preset resolutions VGA: 640x350, 640x480, 720x400 SVGA: 800x600 XGA: 1024x768, 1152x864 SXGA: 1280x1024 WXGA: 1280x720, 1280x768, 1280x800, 1360x768 WXGA+: 1440x900, 1600x900 WSXGA+: 1680x1050 Full HD: 1920x1080, 1920x1200 UHD: 3840x2160</p> <p>Presets / user settings Standard presets: 20; user settings: 20</p>							
<p>Viewing adjustments Tilt: 30° back, -5° forward; lift: 3.15" (80mm); swivel: +/-45° Rotating screen Screen pivots 90 degrees from landscape to portrait On screen display On screen display with digital user controls (8 languages) Control features Direct access (touch buttons on front) for menu, mute, volume up/down, and brightness USB hub USB Hub: one USB 3.0 upstream port, four USB 3.0 downstream ports Multimedia Integrated stereo speakers (3 watts x 2) Camera None Multiple input Support HDMI, DisplayPort Monitor connectors (1) HDMI (2.0), digital, HDCP-compliant (2) DisplayPort (1.2), digital, HDCP-compliant Signal cables (1) detachable, DisplayPort at each end, digital, 1.8 meter Mounting features Wall or desk mounting using the Extend Arm or third-party accessories meeting the VESA FPMPI® (100mm mount) Security Security keyhole for attachment of optional cable lock (Kensington® lock-compatible)</p>							
<p>Ship group Monitor, detachable stand, Quick start and safety poster, 1.8 meter DisplayPort cable, 1.8 meter USB 3.0 cable, 1.8 meter black power cord, mini DP to DP adapter, power adapter (90W)</p>	<p>Limited Warranty</p> <p>See details at http://support.lenovo.com/en_US/guides-and-manuals/detail.page?DocID=UM008281</p> <p>Accessories</p> <table border="0"> <tr> <td>Kensington MicroSaver Cable Lock</td> <td>73P2582</td> </tr> <tr> <td>Kensington Twin Head Cable Lock</td> <td>45K1620</td> </tr> <tr> <td>Lenovo Security Cable Lock</td> <td>57Y4303</td> </tr> </table> <p>See details at www.lenovo.com/support/monitoraccessories</p> <p>See all monitors at www.lenovo.com/thinkvision</p>	Kensington MicroSaver Cable Lock	73P2582	Kensington Twin Head Cable Lock	45K1620	Lenovo Security Cable Lock	57Y4303
Kensington MicroSaver Cable Lock	73P2582						
Kensington Twin Head Cable Lock	45K1620						
Lenovo Security Cable Lock	57Y4303						

See footnotes for important warranty information



<p>Name P27q Wide Flat Panel Monitor Case color Black Type-model 61A8GAR1US / 61A8GAT1EU Panel TFT-LCD, IPS (In-Plane Switching), White LED backlight Viewable image size 27" (685.8mm) diagonal Max view area (W x H) 23.49" x 13.21" (596.7mm x 335.7mm) Optimum resolution 2560x1440 Max pixel rate 300MHz Aspect ratio 16:9 Pixel pitch (mm) 0.2331 x 0.2331mm Dot/Pixel per Inch 109 dpi Brightness 350 nits or cd/m² (typical) Contrast ratio 1000:1 (typical) Pixel response time 4ms Color gamut 99% sRGB Viewing angle at 10:1 CR 178° horizontal, 178° vertical Stand Tilt, swivel, pivot, and height adjustable stand Bezel width <i>Sides:</i> 0.08" (2mm) Dimensions 20.21" H x 24.17" W x 10.62" D; (HxWxD, including stand) 513mm H x 614mm W x 269.8mm D Power supply 38 watts typical, 75 watts maximum (with USB), <0.5 watts sleep/off; <0.3 watts switch off integrated (no external brick-like power supply) Weight 15.43 lb; 7.0kg (including stand) Limited warranty 3 year Available date January 2017</p>	<p>Features</p> <ul style="list-style-type: none"> • 27-inch IPS LED backlit monitor • Supports 2560x1440 resolution • 5-Ports USB hub, support USB 3.0 • Support ThinkCentre Tiny • Microsoft® Windows® 7 certified • Microsoft Windows 10 certified 						
<p>VESA-compliant VESA DDC2B/CI Power management ENERGY STAR® 7.0 Ergonomics ISO 9241-307 Emission standards FCC Class B Environmental TCO Displays 7.0, RoHS, EPEAT™ Gold rating, ULE Gold</p>	 <p>ThinkVision P27q Monitor</p>						
<p>Preset resolutions VGA: 640x480, 720x400 SVGA: 800x600 XGA: 1024x768 SXGA: 1280x1024 WXGA: 1366x768 WXGA+: 1440x900, 1600x900 WSXGA+: 1680x1050 Full HD: 1920x1080, 1920x1200 QHD: 2560x1440</p> <p>Presets / user settings Standard presets: 20; user settings: 24</p>							
<p>Viewing adjustments <i>Tilt:</i> 30° back, -5° forward; <i>lift:</i> 4.33" (110mm); <i>swivel:</i> +/-45° Rotating screen Screen pivots 90 degrees from landscape to portrait On screen display On screen display with digital user controls (8 languages) Control features Direct access for menu, source switch, and brightness USB hub USB Hub: one USB 3.0 upstream port, four USB 3.0 downstream ports Multimedia Audio-out, optional sound bar supported Camera None Multiple input Support HDMI, DisplayPort, mini DisplayPort, DisplayPort-out Monitor connectors (1) 2*HDMI (1.4), digital, HDCP-compliant (2) DisplayPort (1.2), digital, HDCP-compliant (3) Mini DisplayPort, digital, HDCP-compliant Signal cables (1) detachable, mini DisplayPort to DisplayPort, digital, 1.8 meter Mounting features Wall or desk mounting using the Extend Arm or third-party accessories meeting the VESA FPMPI® (100mm mount) Security Security keyhole for attachment of optional cable lock (Kensington® lock-compatible)</p>							
<p>Ship group Monitor, detachable stand, Quick start and safety poster, 1.8 meter USB 3.0 cable, 1.8 meter mini DP to DP cable, 1.8 meter black power cord</p>	<p>Limited Warranty</p> <p>See details at http://support.lenovo.com/en_US/guides-and-manuals/detail.page?DocID=UM008281</p> <p>Accessories</p> <table border="0"> <tr> <td>Kensington MicroSaver Cable Lock</td> <td>73P2582</td> </tr> <tr> <td>Kensington Twin Head Cable Lock</td> <td>45K1620</td> </tr> <tr> <td>Lenovo Security Cable Lock</td> <td>57Y4303</td> </tr> </table> <p>See details at www.lenovo.com/support/monitoraccessories</p> <p>See all monitors at www.lenovo.com/thinkvision</p>	Kensington MicroSaver Cable Lock	73P2582	Kensington Twin Head Cable Lock	45K1620	Lenovo Security Cable Lock	57Y4303
Kensington MicroSaver Cable Lock	73P2582						
Kensington Twin Head Cable Lock	45K1620						
Lenovo Security Cable Lock	57Y4303						



<p>Name Pro2820 Wide Flat Panel Monitor Case color Black Type-model 60FCRAR6US / 60FCRAT6US / 60FCRAT6EU Panel TFT-LCD, with wide viewing angle (WVA) technology, White LED backlight Viewable image size 28" (711mm) diagonal Max view area (W x H) 24.44" x 13.44" (620.9mm x 341.3mm) Optimum resolution 1920x1080 Max pixel rate 205MHz (VGA); 165MHz(DP/ HDMI); 149MHz (MHL) Frequency Supports 1920 x 10800 @ 60Hz Aspect ratio 16:9 Pixel pitch (mm) 0.32 x 0.32mm Dot/Pixel per Inch 79 dpi Brightness 300 nits or cd/m² (typical) Contrast ratio 3000:1 (typical) Pixel response time 6.5ms Color gamut 72% Viewing angle at 10:1 CR 178° horizontal, 178° vertical Stand Tilt, swivel, and height adjustable stand Bezel width Sides: 0.86" (21.85mm) Dimensions (HxWxD, excluding stand) 17.45" H x 26.21" W x 2.30" D; Dimensions (HxWxD, including stand) 443.3mm H x 665.9mm W x 58.2mm D Power supply 60 watts typical, 90 watts typical (with USB), 65 watts maximum, 95 watts maximum (with USB), <1.2 watts sleep/off; <0.5 watts switch off integrated (no external brick-like power supply) Weight 17.84 lb; 8.11kg (including stand) Limited warranty⁴ 3 year (includes backlight) Available date September 2014</p>	<p style="text-align: center;">Features</p> <ul style="list-style-type: none"> • 28-inch MVA (Multi-domain Vertical Alignment) panel LED backlit monitor • Supports 1920x1080 resolution • 5-Ports USB hub, support USB 3.0 • Arsenic/Mercury free • Microsoft® Windows® 7 • Windows 8/ Windows 8.1 certified 						
<p>VESA-compliant² VESA DDC2B/CI Power management ENERGY STAR® 6.0 Ergonomics ISO 9241-307 Emission standards FCC Class B Environmental TCO Displays 6.0, TCO Certified Edge 1.2, RoHS, EPEAT™ Gold rating, ULE Gold</p> <p>Preset resolutions VGA: 640x480, 720x400 SVGA: 800x600 XGA: 1024x768, 1024x760 SXGA: 1280x1024 WXGA: 1280x720, 1280x800, 1366x768 WXGA+: 1440x900, 1600x900 WSXGA+: 1680x1050 Full HD: 1920x1080 Others: 1152x864</p> <p>Presets / user settings Standard presets: 17; user settings: 17</p>	<div style="text-align: center;">  <p>ThinkVision Pro2820 Monitor</p> </div>						
<p>Viewing adjustments <i>Tilt: 25° back, -5° forward; lift: 4.3" (110mm); swivel: +/-45°</i> Rotating screen Screen pivots 90 degrees from landscape to portrait On screen display On screen display with digital user controls (8 languages) Control features Direct access (touch buttons on front) for automatic image setup, input switch, and brightness USB hub USB Hub: one USB 3.0 upstream port, four USB 3.0 downstream ports Multimedia None Camera None Multiple input Support VGA, HDMI, DisplayPort, MHL connections (Mobile High-definition Link) Monitor connectors (1) VGA 15-pin D-shell, analog (2) HDMI (1.4), digital, HDCP-compliant (3) DisplayPort (1.2), digital, HDCP-compliant</p> <p>Signal cables (1) detachable, VGA 15-pin D-shell at each end, analog, 1.8 meter (2) detachable, DisplayPort at each end, digital, 1.8 meter</p> <p>Mounting features Wall or desk mounting using the Extend Arm or third-party accessories meeting the VESA FPMPI® (100mm mount) Security Security keyhole for attachment of optional cable lock (Kensington® lock-compatible)</p>							
<p>Ship group Monitor, detachable stand, Quick start and safety poster, 1.8 meter DisplayPort cable, 1.8 meter VGA cable, 1.8 meter USB 3.0 cable, 1.8 meter black power cord</p>							
<p style="text-align: center;">Limited Warranty</p> <p>See details at http://support.lenovo.com/en_US/guides-and-manuals/detail.page?DocID=UM008281</p>	<p style="text-align: center;">Accessories</p> <table border="0"> <tr> <td>Kensington MicroSaver Cable Lock</td> <td style="text-align: right;">73P2582</td> </tr> <tr> <td>Kensington Twin Head Cable Lock</td> <td style="text-align: right;">45K1620</td> </tr> <tr> <td>Lenovo Security Cable Lock</td> <td style="text-align: right;">57Y4303</td> </tr> </table> <p>See details at www.lenovo.com/support/monitoraccessories</p> <p>See all monitors at www.lenovo.com/thinkvision</p>	Kensington MicroSaver Cable Lock	73P2582	Kensington Twin Head Cable Lock	45K1620	Lenovo Security Cable Lock	57Y4303
Kensington MicroSaver Cable Lock	73P2582						
Kensington Twin Head Cable Lock	45K1620						
Lenovo Security Cable Lock	57Y4303						

See footnotes for important warranty information



<p>Name X1 Wide Flat Panel Monitor Case color Black Type-model 60E2GAR1US / 60E2GAT1US / 60E2GAT1EU Panel TFT-LCD, IPS (In-Plane Switching), White LED backlight Viewable image size 27" (684.7mm) diagonal Max view area (W x H) 23.49" x 13.21" (596.7mm x 335.7mm) Optimum resolution 3840x2160 Max pixel rate 600MHz Aspect ratio 16:9 Pixel pitch (mm) 0.16 x 0.16mm Dot/Pixel per Inch 163 dpi Brightness 300 nits or cd/m² (typical) Contrast ratio 1300:1 (typical) Pixel response time 6ms Color gamut 99% Viewing angle at 10:1 CR 178° horizontal, 178° vertical Stand Tilt stand Bezel width Sides: 0.088" (2.23mm) Dimensions (HxWxD, including stand) 19.35" H x 24.19" W x 10.63" D; 491.4mm H x 614.5mm W x 270.0mm D Power supply 40 watts typical, 130 watts maximum (with USB), <0.5 watts sleep/off; <0.5 watts switch off Weight 14.11 lb; 6.40kg (including stand) Limited warranty⁴ 3 year Available date March 2016</p>	<p>Features</p> <ul style="list-style-type: none"> • 27-inch IPS LED backlight monitor with speaker • Supports 3840x2160 resolution • 5-Ports USB hub, support USB Type-C • 3watts x 2 stereo speakers • Microsoft® Windows® 7 certified • Microsoft Windows 10 certified 						
<p>VESA-compliant² VESA DDC2B/CI Power management ENERGY STAR® 7.0 Ergonomics ISO 9241-307 Emission standards FCC Class B Environmental TCO Displays 7.0, RoHS, EPEAT™ Silver rating, ULE Gold</p>	 <p style="text-align: center;">ThinkVision X1 Monitor</p>						
<p>Preset resolutions VGA: 640x350, 640x480, 720x400 SVGA: 800x600 XGA: 1024x768, 1152x864 SXGA: 1280x1024 WXGA: 1280x720, 1280x768, 1280x800, 1360x768 WXGA+: 1440x900, 1600x900 WSXGA+: 1680x1050 Full HD: 1920x1080, 1920x1200 UHD: 3840x2160</p> <p>Presets / user settings Standard presets: 20; user settings: 20</p>							
<p>Viewing adjustments <i>Tilt: 22° back, -5° forward;</i> Rotating screen None On screen display On screen display with digital user controls (8 languages) Control features Direct access (touch buttons on front) for menu, mute, volume up/down, and brightness USB hub USB Hub: one USB 3.0 Type-C upstream port, four USB 3.0 downstream ports Multimedia Integrated stereo speakers (3 watts x 2), built-in microphone Camera Full HD camera with LED light Multiple input Support HDMI, DisplayPort Monitor connectors (1) HDMI (1.4), digital, HDCP-compliant (2) DisplayPort (1.2), digital, HDCP-compliant Signal cables (1) detachable, HDMI at each end, digital, 1.8 meter (2) detachable, DisplayPort at each end, digital, 1.8 meter Mounting features Wall or desk mounting using the Extend Arm or third-party accessories meeting the VESA FPMPI® (100mm mount) Security Security keyhole for attachment of optional cable lock (Kensington® lock-compatible)</p>							
<p>Ship group Monitor, detachable stand, Quick start and safety poster, 1.8 meter DisplayPort cable, 1.8 meter HDMI cable, 1.8 meter USB Type-C cable, 1.8 meter USB Type-C to Type-A cable, 1.8 meter black power cord, mini DP to DP adapter, power adapter (135W)</p>	<p style="text-align: center;">Limited Warranty</p> <p>See details at http://support.lenovo.com/en_US/guides-and-manuals/detail.page?DocID=UM008281</p> <p style="text-align: center;">Accessories</p> <table border="0"> <tr> <td>Kensington MicroSaver Cable Lock</td> <td style="text-align: right;">73P2582</td> </tr> <tr> <td>Kensington Twin Head Cable Lock</td> <td style="text-align: right;">45K1620</td> </tr> <tr> <td>Lenovo Security Cable Lock</td> <td style="text-align: right;">57Y4303</td> </tr> </table> <p>See details at www.lenovo.com/support/monitoraccessories</p> <p>See all monitors at www.lenovo.com/thinkvision</p>	Kensington MicroSaver Cable Lock	73P2582	Kensington Twin Head Cable Lock	45K1620	Lenovo Security Cable Lock	57Y4303
Kensington MicroSaver Cable Lock	73P2582						
Kensington Twin Head Cable Lock	45K1620						
Lenovo Security Cable Lock	57Y4303						

See footnotes for important warranty information

Availability: All offers subject to availability. Lenovo reserves the right to alter product offerings and specifications at any time, without notice. Lenovo is not responsible for photographic or typographic errors.

Warranty: For a copy of applicable product warranties, go to: http://support.lenovo.com/en_US/product-service/warranty-status/WarrantyPolicies.page. Lenovo makes no representation or warranty regarding third party products or services.

¹ **ISO-compliant:** Compliance with ISO 9241 Part 3, ISO Part 7, ISO Part 8, and/or ISO 13406 Part 2 is dependent on a complete ISO-capable platform of a system unit, monitor, video subsystem, operating system and fonts.

² **VESA:** Requires attachment to suitably configured system with similarly enabled operating system.

³ **ENERGY STAR:** As an ENERGY STAR partner, Lenovo has determined that this product meets the ENERGY STAR 4.0 or 4.1 guidelines for energy efficiency. Requires attachment to suitably configured system.

⁴ **Limited warranty:** Support unrelated to a warranty issue may be subject to additional charges.

⁵ **International Warranty Service** is available in any country in which this product is sold and serviced. Service delivery methods and parts availability vary by country, may be different from that in the country of purchase, and are subject to change without notice. Fees and restrictions may apply in some countries.

⁶ **Lenovo pays all shipping costs** for warranty repairs during limited warranty period.

⁷ **Lenovo Services:** These services are available for machines normally used for business, professional, or trade purposes, rather than personal, family, or household purposes. Not all machine types and models are covered. Service period begins with the equipment date of purchase. Service must be purchased during the original limited product warranty period. Service levels are response time objectives and are not guarantees. If the machine problem turns out to be a Customer Replaceable Unit (CRU), a part will be express shipped to you for quick replacement. Onsite 24x7x2-hour service is not available in all locations. P&L means parts and labor. P/U means pick-up. See terms and conditions for complete details and restrictions.

⁸ **Telephone support** may be subject to additional charges, even during the limited warranty period. Response times may vary. May exclude some holidays. If a machine is listed as having "On-site service for select repairs", this means that onsite service is available only for the replacement of select parts. For all other warranty repairs, Lenovo will provide the customer a replacement part for customer installation. The parts for which onsite service is available varies by machine, but may include the processor, power supply, heat sink, system board, or base cover. For machines with EasyServ or Courier service, Lenovo will attempt to diagnose and resolve the problem remotely before sending a courier.

¹⁰ **TAA:** Monitor is compliant with the U.S. Federal Government's country-of-origin requirements prescribed in 48 C.F.R. Subpart 25.4; Trade Act Agreement (TAA) model.

¹¹ **Post-warranty annual maintenance agreement:** Service begins at the end of the base warranty or the end of any other applied warranty and maintenance option, whichever occurs last. Service delivery is not available the same day the maintenance agreement is purchased. Maintenance agreements must be purchased and the registration successfully completed prior to the service being available.

¹² **Halogen:** Less than 900 Parts Per Million. Low halogen is defined in accordance with IPC-401B and draft IPC-J-STD 709 Class 1 requirements.

ThinkVision®

Trademarks: Lenovo, the Lenovo logo, New World. New Thinking., Access Connections, Rescue and Recovery, ThinkCentre, ThinkPad, ThinkStation, ThinkVantage, and ThinkVision are trademarks of Lenovo. Microsoft, Windows, and Vista are registered trademarks of Microsoft Corporation. Other company, product, or service names may be trademarks or service marks of others.

This publication was developed for products and services offered in the United States. Lenovo may not offer the products, services or features discussed in this document in other countries. Lenovo may withdraw an offering at any time. Information is subject to change without notice. Consult your local representative for information on offerings available in your area.

Lenovo reserves the right to alter specifications and other product information at any time without prior notice. Lenovo is not responsible for photographic or typographical errors. **LENOVO PROVIDES THIS PUBLICATION "AS IS" WITHOUT WARRANTY OF ANY KIND, EITHER EXPRESS OR IMPLIED, INCLUDING THE IMPLIED WARRANTIES OF MERCHANTABILITY OR FITNESS FOR A PARTICULAR PURPOSE.** Some jurisdictions do not allow disclaimer of express or implied warranties in certain transactions; therefore this disclaimer may not apply to you. This publication was developed in the US.

Visit www.lenovo.com/safecomputing periodically for the latest information on safe and effective computing.

Visit www.lenovo.com/psref for the latest version of Product Specifications Reference.

© Lenovo, 2017.
All rights reserved.

Lenovo
1009 Think Place
Morrisville, NC 27560
U.S.A.

ThinkVision.pdf